

2024 waterjet parts price book

Premium waterjet parts at affordable prices

Replacement parts for:

AccuStream, BFT, Flow,
Jet Edge, KMT, WSI,
HP Components

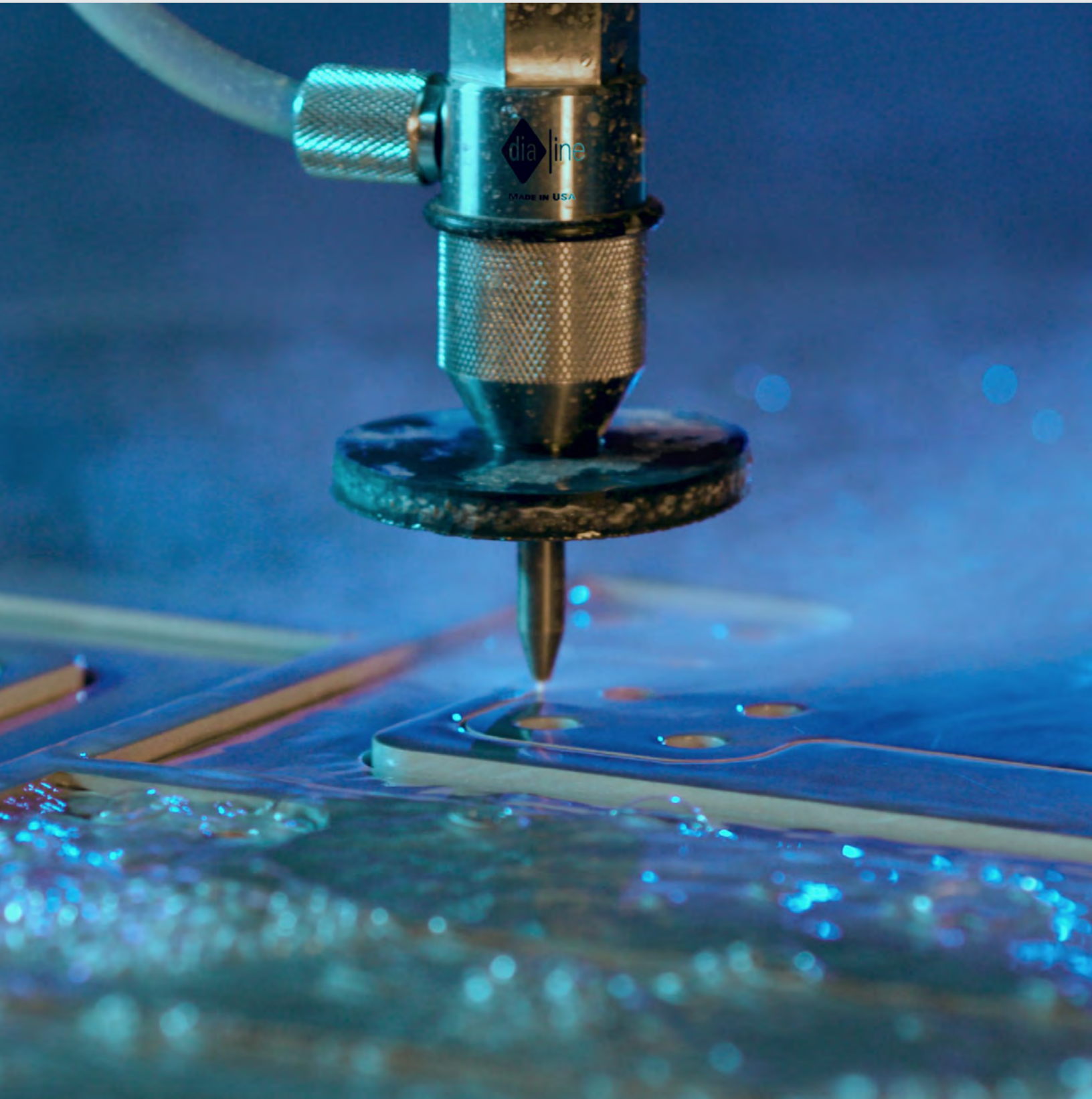

We have worked a lifetime on your shop floor

AccuStream® waterjet parts and consumables are part of the Hypertherm Associates family, a 100% Associate-owned company composed of the world-class portfolio of industrial cutting and shaping technologies and solutions you know and trust – plasma, waterjet, CAD/CAM, robotic software, and more – to help our customers succeed in ways that have never before been possible. With a constancy of purpose, a drive to innovate, and a passion for customer success, Hypertherm Associates is leading the industrial cutting and shaping industry.

AccuStream has worked a lifetime on your shop floor and has been in the waterjet business from the beginning. Our founder was an industry pioneer, leading research and development on the first generations of high-pressure intensifier pumps.

Early on, he opened a waterjet job shop – the shop that would be the genesis of AccuStream.

Born and raised as a waterjet job shop, we proved ourselves by overcoming the same challenges you confront every day: staying competitive in the market, keeping machines running, finding affordable replacement parts and technical service, and quickly making repairs to get back into production. In our search for the best ways to be competitive and conquer other keep-you-up-at-night dilemmas, we found a recurring truth – we were uniquely positioned to develop replacement parts for waterjets. And not just any replacement parts, but parts that met our own high standards for component life, quality, availability and price. This is the idea that launched AccuStream and our products for all waterjets.

We felt from the beginning that providing long-lasting, high-quality parts was not enough. As a waterjet user, you need a partner who you can depend on to pick up the phone when you call, answer your waterjet questions, help with your day-to-day waterjet dilemmas, and deliver parts with the sense of urgency demanded by your business. A partner who can get you what you need when you need it. How do we know? We've been there.

As owners of Hypertherm Associates, we're taking that care to a whole new level because each of us has a vested interest in your satisfaction and a strong drive to provide the best products and services. Let us earn your business with replacement parts engineered and manufactured in America. Parts that can lower your cost of ownership by delivering more cuts, more work hours, increased productivity, and ultimately greater profitability. Parts delivered with a level of service that you will only find with AccuStream.



Contents

AccuStream® parts

- 4 Orifices
 - 4 DiaLine orifices
 - 4 A2 orifices
 - 4 Thimble filters
- 5 Nozzles
 - 5 DiaLine nozzles
 - 6 A2 nozzles
- 7 Cutting heads
 - 8 DiaLine cutting heads
 - 9 DiaLine adapters
 - 9 AccuValve adapters
 - 9 Water-only conversion parts
- 12 Cutting heads
 - 12 DiaLine4 cutting head
 - 12 DiaLine4 parts
 - 12 DiaLine4 orifices
- 13 On/off valves
 - 14 DiaLine on/off valves
 - 15 DiaLine on/off valve mounting hardware
 - 15 AccuLine water-only on/off valves
- 17 Waterjet products
 - 17 Waterjet bricks
 - 17 Hypertherm abrasive regulators
 - 18 Continuous feed hopper
 - 18 Reverse osmosis systems

Replacement parts for BFT

- 20 Pump parts
- 20 Parts

Replacement parts for Flow

- 24 Orifices
 - 24 New-style orifices
 - 24 PASER 4 orifices
 - 24 PASER 3 orifices
 - 24 PASER 2 orifices
 - 24 Standard-mount orifices
 - 24 Low-mass orifices
- 25 Mixing tubes (nozzles)
 - 25 .281 ROCTEC 100 mixing tubes
 - 25 .281 ROCTEC 100 mixing tubes with performance locating rings
 - 25 .281 ROCTEC 500 mixing tubes
 - 26 .281 ROCTEC 500 mixing tubes with performance locating rings
- 27 Cutting heads
 - 27 PASER 3 cutting heads
 - 27 PASER 4 cutting heads
 - 28 DiaLine cutting heads
 - 29 XD cutting head

- 30 Nozzle tubes (nozzle bodies)
- 30 Nozzle orifice retainers
- 31 On/off valves
 - 31 Insta 1 on/off valves
 - 32 Insta 2 on/off valves
 - 33 Mini on/off valves
 - 34 Universal on/off valves (60K and 94K)
 - 34 H₂O high-performance on/off valve
- 35 Pump parts
 - 35 Repair kits: Seals
 - 35 Repair kits: Check valves
 - 35 Repair kits: Bleed-down and blow-down valves
 - 36 Replacement parts
 - 40 Flow Hyplex
 - 40 Kits
 - 40 Replacement parts
 - 42 87k Kits
 - 42 87k replacement parts
 - 43 87k swivels
 - 43 87k tools
 - 44 Filters

Replacement parts for Jet Edge

- 46 Orifices
 - 46 Permalign II orifices
 - 46 Threaded orifices
- 46 Nozzles
 - 46 .250 ROCTEC® 100 nozzles
- 46 Cutting heads
 - 46 Permalign II cutting heads
- 47 On/off valves
 - 47 Repair kits
 - 47 Replacement parts
- 48 Pump parts
 - 48 7/8 inch
 - 50 1 inch
 - 52 Filters

Replacement parts for KMT

- 54 Orifices
 - 54 Autoline orifices
 - 54 Long-stem orifices
- 54 Focusing tubes
 - 54 .375 ROCTEC® 100 focusing tubes
 - 54 .375 ROCTEC® 500 focusing tubes
- 55 Cutting heads
 - 55 60K
- 56 On/off valves
 - 56 60K
 - 57 100K

- 58 Pump parts
 - 58 Streamline SL-IV and SL-V
 - 60 Filters
 - 62 Streamline SL-V 75/100S

Replacement parts for WSI

- 64 On/Off valves
 - 64 Repair kits
 - 64 Replacement parts
- 65 Pump parts
 - 65 Repair kits: Seals
 - 65 Repair kits: Check valves
 - 65 Replacement parts

Replacement parts for high-pressure components

- 69 High-pressure tubing
 - 69 60k tubing
 - 70 100k tubing
 - 70 Protective sheathing
- 71 60K fittings
 - 71 Swivel repair kits
 - 72 Swivels
 - 73 Straight couplings
 - 73 Straight reducer couplings
 - 73 Collars
 - 73 Glands
 - 74 Plugs
 - 74 Adapters
 - 74 Crosses
 - 74 Tees
 - 75 Elbows
 - 75 Two-way straight valves
 - 75 Two-way angle valves
 - 75 Three-way angle valves
 - 75 Inline wyes
 - 76 Antivibration assemblies
- 76 100K fittings
 - 76 Swivels
 - 76 Antivibration assemblies
 - 76 Collars
 - 76 Glands
 - 76 Plugs
 - 77 Crosses
 - 77 Tees
 - 77 Elbows
- 78 Nipples
 - 78 1/4 inch
 - 78 3/8 inch
 - 78 9/16 inch
- 79 Hardware
 - 79 Tube clamp pairs
 - 79 Inline filters
- 80 Tools
 - 80 Coning and threading tools
 - 82 Other tools
- 83 Lubricants
- 83 Gauges

AccuStream® parts



AccuStream® parts

Orifices

DialLine orifices

AccuStream #	Description	Price	
1-12835-XXX	Ruby Orifice Use for water and abrasive applications.	\$19.50	
1-12749-XXX	Diamond Orifice Use for water and abrasive applications.	\$425.00	
1-22835-XXX	Ultra Sapphire Orifice	\$23.50	

A2 orifices

AccuStream #	Description	Price	
1-11007-XXX	Ruby Orifice Use for water and abrasive applications.	\$16.00	
1-11007DA-XXX	Diamond Orifice, Abrasive	\$450.00	
1-11007D-XXX	Diamond Orifice, Water-only	\$425.00	
1-21007-XXX	Ultra Sapphire Orifice	\$19.00	

-XXX indicates the availability of multiple sizes. Call us or visit AccuStream.com for details.

Thimble filters

AccuStream #	Description	Price	
1-14279	Thimble Filter Assembly, 1/4-in. Female to 1/4-in. Male	\$194.00	
1-14281	Thimble Filter Bullet, 1/4 in. Use with 1-14279 Thimble Filter Assembly.	\$45.00	
1-13553	Thimble Filter Assembly, 1/4-in. Female to 3/8-in. Male	\$194.00	
1-11394	Adapter, 1/4-in. Female to 3/8-in. Male	\$76.00	
1-12533	Thimble Filter Element and Bullet Use with 1-13553 Thimble Filter Assembly.	\$148.00	
1-11288	Thimble Filter Coned Bullet Insert, 3/8 in. Use with 1-13553 Thimble Filter Assembly.	\$12.50	
1-13174	Thimble Filter Assembly, 3/8-in. Female to 3/8-in. Male	\$194.00	
1-12401	Thimble Filter Element	\$136.00	

Nozzles

DiaLine nozzles

.281 ROCTEC® 100 nozzles

AccuStream #	Description	Price
1-12779-020-20	.281 Nozzle, .020 in. × 2.00 in.	\$75.00
1-12779-020-30	.281 Nozzle, .020 in. × 3.00 in.	\$75.00
1-12779-020-40	.281 Nozzle, .020 in. × 4.00 in.	\$85.00
1-12779-030-30	.281 Nozzle, .030 in. × 3.00 in.	\$75.00
1-12779-030-35	.281 Nozzle, .030 in. × 3.50 in.	\$85.00
1-12779-030-40	.281 Nozzle, .030 in. × 4.00 in.	\$85.00
1-12779-035-30	.281 Nozzle, .035 in. × 3.00 in.	\$75.00
1-12779-035-40	.281 Nozzle, .035 in. × 4.00 in.	\$85.00
1-12779-040-20	.281 Nozzle, .040 in. × 2.00 in.	\$75.00
1-12779-040-30	.281 Nozzle, .040 in. × 3.00 in.	\$75.00
1-12779-040-35	.281 Nozzle, .040 in. × 3.50 in.	\$85.00
1-12779-040-40	.281 Nozzle, .040 in. × 4.00 in.	\$85.00
1-12779-045-30	.281 Nozzle, .045 in. × 3.00 in.	\$75.00
1-12779-050-30	.281 Nozzle, .050 in. × 3.00 in.	\$75.00
1-12779-050-35	.281 Nozzle, .050 in. × 3.50 in.	\$85.00

.281 ROCTEC® 500 nozzles

AccuStream #	Description	Price
1-11277-020-20	.281 Nozzle, .020 in. × 2.00 in.	\$180.00
1-11277-030-30	.281 Nozzle, .030 in. × 3.00 in.	\$130.00
1-11277-030-40	.281 Nozzle, .030 in. × 4.00 in.	\$140.00
1-11277-035-30	.281 Nozzle, .035 in. × 3.00 in.	\$130.00
1-11277-035-40	.281 Nozzle, .035 in. × 4.00 in.	\$140.00
1-11277-040-30	.281 Nozzle, .040 in. × 3.00 in.	\$130.00
1-11277-040-40	.281 Nozzle, .040 in. × 4.00 in.	\$140.00
1-11277-045-30	.281 Nozzle, .045 in. × 3.00 in.	\$130.00
1-11277-050-30	.281 Nozzle, .050 in. × 3.00 in.	\$130.00
1-11277-050-40	.281 Nozzle, .050 in. × 4.00 in.	\$140.00

AccuStream® parts

Nozzles

A2 nozzles





.300 ROCTEC® 100 nozzles

AccuStream #	Description	Price	
1-12781-020-30	.300 Nozzle, .020 in. × 3.00 in.	\$75.00	
1-12781-030-30	.300 Nozzle, .030 in. × 3.00 in.	\$75.00	
1-12781-030-40	.300 Nozzle, .030 in. × 4.00 in.	\$85.00	
1-12781-035-30	.300 Nozzle, .035 in. × 3.00 in.	\$75.00	
1-12781-040-30	.300 Nozzle, .040 in. × 3.00 in.	\$75.00	
1-12781-040-40	.300 Nozzle, .040 in. × 4.00 in.	\$85.00	
1-12781-045-30	.300 Nozzle, .045 in. × 3.00 in.	\$75.00	

.300 ROCTEC® 500 nozzles

AccuStream #	Description	Price	
1-13189-030-30	.300 Nozzle, .030 in. × 3.00 in.	\$130.00	
1-13189-040-30	.300 Nozzle, .040 in. × 3.00 in.	\$130.00	

Replacement parts

AccuStream #	Description	Price	
1-12276	Collet, .300 in.	\$7.30	
1-12762	Inlet Tube	\$43.75	
1-11362	Nozzle Splash Guard, Carbide	\$77.00	
1-11361	Nozzle Splash Guard, Rubber	\$7.10	

DiaLine™ from AccuStream®

The industry's FIRST customizable cutting head

600 hours – that's the longest diamond warranty in the industry and it's only available with the DiaLine cutting head from AccuStream. The DiaLine cutting head not only lasts longer, it cuts more accurately and is the most customizable cutting head available. The DiaLine from AccuStream isn't just another cutting head. It's the best cutting head.









AccuStream® parts







Cutting heads

DiaLine cutting heads

Single-inlet assemblies





AccuStream #	Description	Price	
1-13904-2-1-1	.281 DiaLine Cutting Head Assembly Single 3/8-in. inlet, includes standard nozzle nut	\$439.00	
1-13904-2-1-2	.281 DiaLine Cutting Head Assembly Single 3/8-in. inlet, includes 3-in. clamping nut, nozzle splash guard	\$560.00	
1-13904-2-1-3	.281 DiaLine Cutting Head Assembly Single 3/8-in. inlet, includes 4-in. clamping nut, nozzle splash guard	\$590.00	
1-13904-2-2-1	.281 DiaLine Cutting Head Assembly Single 3/16-in. inlet, includes standard nozzle nut	\$442.00	
1-13904-2-2-2	.281 DiaLine Cutting Head Assembly Single 3/16-in. inlet, includes 3-in. clamping nut, nozzle splash guard	\$560.00	
1-13904-2-2-3	.281 DiaLine Cutting Head Assembly Single 3/16-in. inlet, includes 4-in. clamping nut, nozzle splash guard	\$590.00	

Dual-inlet assemblies



AccuStream #	Description	Price	
1-13904-3-1-1	.281 DiaLine Cutting Head Assembly Dual 3/8-in. inlets, includes standard nut	\$560.00	
1-13904-3-1-2	.281 DiaLine Cutting Head Assembly Dual 3/8-in. inlets, includes 3-in. clamping nut, nozzle splash guard	\$675.00	
1-13904-3-1-3	.281 DiaLine Cutting Head Assembly Dual 3/8-in. inlets, includes 4-in. clamping nut, nozzle splash guard	\$710.00	
1-13904-3-2-1	.281 DiaLine Cutting Head Assembly Dual 3/16-in. inlets, includes standard nut	\$560.00	
1-13904-3-2-2	.281 DiaLine Cutting Head Assembly Dual 3/16-in. inlets, includes 3-in. clamping nut, nozzle splash guard	\$675.00	
1-13904-3-2-3	.281 DiaLine Cutting Head Assembly Dual 3/16-in. inlets, includes 4-in. clamping nut, nozzle splash guard	\$710.00	

Cutting heads





DiaLine adapters

AccuStream #	Description	Price	
1-11358-4	Adapter, DiaLine to Flow® Short nozzle body, 4.330 in.	\$253.00	
1-11755	Adapter, DiaLine to KMT®	\$202.00	
1-11009	Adapter, A2 to Jet Edge™, 3.5-in. Use with 1-11010 valve seat.	\$219.00	
1-11756	Swivel Adapter, DiaLine to Jet Edge™	\$208.00	
1-13841	Swivel Adapter, DiaLine to Jet Edge™, 7.50 in. Use with 1-11010 valve seat.	\$211.00	

AccuValve adapters

AccuStream #	Description	Price	
1-13730	Swivel Adapter, 2.315 in. Use with DiaLine cutting head assemblies.	\$200.00	
1-13841	Swivel Adapter, 3.395 in. Use with DiaLine cutting head assemblies.	\$211.00	
1-13839	Swivel Adapter, 4.985 in. Use with DiaLine cutting head assemblies.	\$253.00	

Water-only conversion parts















AccuStream #	Description	Price	
1-14321	Water-only Conversion Kit Use with 1-12835-XXX or 1-12749-XXX DiaLine Orifices. Includes adapter, seat, retainer nut	\$279.00	
1-14233	Adapter, Water-only	\$199.00	
1-14232	Seat, Water-only	\$32.00	
1-11299	Nozzle Retainer Nut	\$65.00	

AccuStream® parts

Cutting heads

DialLine cutting heads

Replacement parts

AccuStream #	Description	Price	
1-12747	Mixing Chamber Use with single-inlet cutting head assemblies.	\$177.00	
1-13556	Mixing Chamber Use with dual-inlet cutting head assemblies.	\$177.00	
1-13879	Abrasive Body Assembly Use with single-inlet cutting head assemblies. Includes mixing chamber, retainer collet, O-rings	\$370.00	
1-13901	Abrasive Body Assembly Use with dual-inlet cutting head assemblies. Includes mixing chamber, retainer collet, O-rings	\$438.00	
1-12752	Abrasive Inlet Connector, 3/8 in. Use with single-inlet and dual-inlet cutting head assemblies.	\$27.50	
1-13820	Abrasive Inlet Connector, 3/16 in. Use with single-inlet and dual-inlet cutting head assemblies.	\$31.00	
1-11679-012	Inlet O-ring	\$1.55	
1-11357	Retainer Collet	\$8.20	
1-12836	Set Screw	\$1.70	
1-11679-216	O-ring, -216	\$1.55	
1-13632	Clamping Nut, 3 in. Accepts 1-13727 Nozzle Splash Guard	\$131.00	
1-13848	Clamping Nut, 4-in. Accepts 1-13727 Nozzle Splash Guard	\$170.00	
1-12751	Nozzle Nut, Standard Does not accept 1-13727 Nozzle Splash Guard	\$62.00	
1-13727	Nozzle Splash Guard Use with 1-13198 Clamping Nut.	\$36.25	
1-13198	Clamping Nut	\$45.50	

Looking for orifices? See page 6. Looking for nozzles? See page 7. Looking for on/off valve repair kits? See page 19.

DiaLine4™ from AccuStream®

Direct replacement for the Flow Paser 4

The DiaLine4 is built with the same rigorous engineering used in our DiaLine cutting heads today. The DiaLine4's patent-pending cutting head technology is engineered to be a direct replacement for the Flow Paser 4 cutting head, requiring no additional configuring.











AccuStream® parts

Cutting heads



DiaLine4 cutting head

AccuStream #	Description	Replaces	Price	
1-18741	DiaLine4 complete assembly	041136-1	\$745.00	

DiaLine4 parts

AccuStream #	Description	Replaces	Price	
1-11357	Collet		\$8.20	
1-11679-212	O-ring, -212		\$1.55	
1-12747	Mixing chamber		\$177.00	
1-12752	Abrasive Inlet Connector, 3/8 in.		\$27.50	
1-12836	Set screw		\$1.70	
1-14465	Blast disc	711933-1	\$6.20	
1-18717	Nozzle splash guard	711621-1 040411-1	\$16.00	
1-18718	Abrasive body	041138-1	\$372.00	
1-18719	Nozzle nut		\$132.00	

DiaLine4 orifices

AccuStream #	Description	Price	
1-12749-XXX	Diamond orifice	\$425.00	
1-22835-XXX	Ultra sapphire orifice	\$23.50	
1-12835-XXX	Ruby orifice	\$19.50	

-XXX indicates the availability of multiple sizes. Call us or visit AccuStream.com for details.

AccuValve on/off valve

Rated for pressures up to 65K









The AccuValve is designed for flexible production in either pure water or abrasive waterjet cutting applications. Lightweight with a compact design, the AccuValve can be mounted on any motion system and provides responsive on/off control for pressures up to 65K. With long-life components and easy maintenance, the AccuValve ensures maximum uptime.



AccuStream® parts

On/off valves



DialLine on/off valves

AccuStream #	Description	Price	
1-13903-1-1-1	On/off Valve, Top-inlet, 6.375 in. (A-dimension) Includes 6.375-in. swivel adapter	\$1,070.00	
1-13903-1-1-2	On/off Valve, Top-inlet, 7.50 in. (A-dimension) Includes 7.50-in. swivel adapter	\$1,090.00	
1-13903-1-1-3	On/off Valve, Top-inlet, 9.075 in. (A-dimension) Includes 9.075-in. swivel adapter	\$1,120.00	
1-13903-1-2-1	On/off Valve, Top-inlet, High-performance, 6.375 in. (A-dimension) Includes 6.375-in. swivel adapter	\$1,170.00	
1-13903-1-2-2	On/off Valve, Top-inlet, High-performance, 7.50 in. (A-dimension) Includes 7.50-in. swivel adapter	\$1,190.00	
1-13903-1-2-3	On/off Valve, Top-inlet, High-performance, 9.075 in. (A-dimension) Includes 9.075-in. swivel adapter	\$1,230.00	
1-13903-2-1-1	On/off Valve, Side-inlet, 6.375 in. (A-dimension) Includes 6.375-in. swivel adapter	\$1,080.00	
1-13903-2-1-2	On/off Valve, Side-inlet, 7.50 in. (A-dimension) Includes 7.50-in. swivel adapter	\$1,100.00	
1-13903-2-1-3	On/off Valve, Side-inlet, 9.075 in. (A-dimension) Includes 9.075-in. swivel adapter	\$1,140.00	
1-13903-2-2-1	On/off Valve, Side-inlet, High-performance, 6.375 in. (A-dimension) Includes short swivel adapter	\$1,170.00	
1-13903-2-2-2	On/off Valve, Side-inlet, High-performance, 7.50 in. (A-dimension) Includes 7.50-in. swivel adapter	\$1,190.00	
1-13903-2-2-3	On/off Valve, Side-inlet, High-performance, 9.075 in. (A-dimension) Includes 9.075-in. swivel adapter	\$1,230.00	







Looking for swivels? See page 78.

On/off valves

DiaLine on/off valve mounting hardware

AccuStream #	Description	Price	
1-11198	AccuValve Front-mounting Collar, Standard	\$222.00	
1-13878	AccuValve Back-mounting Collar	\$222.00	
1-14142	Valve Body Mounting Plate, High-performance	\$126.00	

AccuLine water-only on/off valves



AccuStream #	Description	Price	
1-13903-1-1-4	AccuLine On/off Valve, Top-inlet	\$1,140.00	
1-13903-1-2-4	AccuLine On/off Valve, Top-inlet, High-performance Use for high-cycle applications	\$1,260.00	
1-13903-2-1-4	AccuLine On/off Valve, Side-inlet	\$1,160.00	
1-13903-2-2-4	AccuLine On/off Valve, Side-inlet, High-performance Use for high-cycle applications	\$1,260.00	
1-12881	Adapter, Water-only Use with AccuLine On/off Valves	\$211.00	
1-12849	Water-only Nut Use with 1-12881 Water-only Adapter	\$80.00	

AccuLine assemblies are for water-only cutting heads. Use with 1-11007D-XXX Water-only Diamond Orifice or 1-11007-XXX Ruby Orifice. Looking for orifices? See page 6.



AccuStream® parts

On/off valves







Repair kits

AccuStream #	Description	Price	
1-12686	AccuValve Actuator Repair Kit Includes exhaust muffler, springs, fitting, snap rings, O-rings	\$91.00	
1-11328	On/off Valve and Bleed-down Valve Repair Kit Includes 1-11010 AccuSeat, needle, needle bearing, valve seal	\$103.00	
1-13683	High-cycle On/off Valve Repair Kit Includes 1-11010 AccuSeat, needle, needle guide, valve seal	\$165.00	

Assemblies

AccuStream #	Description	Price	
1-12828	AccuValve Assembly, Top-inlet	\$565.00	
1-13732	AccuValve Assembly, Side-inlet	\$565.00	

Replacement parts

AccuStream #	Description	Price	
1-11033	AccuValve Valve Body	\$285.00	
1-14141	AccuValve Valve Body, High-performance	\$313.00	
1-11010	AccuSeat	\$26.25	
1-11562	Needle	\$36.00	
1-13682	Straight Needle, High-cycle	\$116.00	
1-12178	Needle Bearing	\$36.50	
1-11043	Valve Seal	\$15.60	

Waterjet products

Waterjet bricks

AccuStream #	Description	< 48	Pallet of 48	Pallet of 96
1-11124B	Black Waterjet Bricks	\$38.00	\$35.00	\$33.00
1-11124W	White Waterjet Bricks			

Prices are per brick. Bricks are 4 in. × 6 in. × 48 in.

AccuStream #	Description	Price
1-11124B-6	Black Waterjet Bricks 6-pack	\$228.00
1-11124W-6	White Waterjet Bricks 6-pack	\$228.00

Waterjet cutting bricks are specially designed and manufactured to fully support parts during the waterjet cutting process. Made from a unique high-density polyethylene (HDPE), the bricks use a laminated flute pattern to minimize splashback from the jet while draining water and debris away quickly and effectively.

- Avoids part “frosting” from jet splashback
- Prevents small parts from falling into the catch tank
- Lightweight (11.4 lb per brick) and easy to handle
- Corrugation draws water and abrasive away from the cutting surface
- Corrosion free



Hypertherm abrasive regulators

Accustream #	Description	Price
1-19383	Hypertherm Abrasive Regulator III	\$1,370.00

Abrasive is the highest operating expense in abrasive waterjet cutting. Optimizing abrasive usage is key to enhancing the profitability of waterjet operations. The accuracy and versatility of the Abrasive Regulator III improve the cutting process and avoid waste by precisely delivering abrasive to the cutting head. With 30 settings that can be easily and quickly dialed in, the right amount of abrasive is consistently delivered to the cutting head.



Waterjet products

Continuous Feed Hopper

Accustream #	Description	Price
10082262	Continuous Feed Hopper 600-pound capacity	\$5,500.00

The innovative Continuous Feed Hopper improves your production times by automatic garnet delivery to the abrasive waterjet nozzle. Utilizing pneumatic pressure to transport garnet from the large capacity 600lb (272 kg) hopper pot to the cutting head hopper, the Continuous Feed Hopper helps to eliminate unplanned downtime with the ability to fill the hopper while in use.



















Replacement parts for BFT

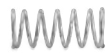

BFT parts

Pump parts

Parts



AccuStream #	Description	Replaces	Price	
1-16396	Valve Seat	WJ055003/168	\$54.50	
1-18262	Valve Stem	WJ070005/551	\$54.50	
1-18263	HP Gasket	WJ070009/150	\$21.30	
1-18264	O-Ring 4.3 x 2.4	OR0043024/151	\$1.10	
1-18265	Guide Bushing	WJ055023/527	\$39.50	
1-16395	Valve Seat	CP022046/593	\$79.00	
1-16390	Lens	CP022042/593	\$79.00	
1-16394	Valve Insert	CP022045/775	\$25.50	
1-18266	Ball Dia. 6	K016/660	\$8.00	
1-18267	Spring	XF97/220	\$6.90	
1-18268	Safety Bolt	CP020052/220	\$4.85	
1-18272	Piston Sealing	XK121/220	\$53.50	
1-18273	Guide Ring	XF56/220	\$32.00	
1-18276	O-Ring backring 97	034858/220	\$26.75	
1-18277	Rod Wear Ring	XF29/220	\$12.80	
1-16388	Bearing Bush	CP022010/527	\$47.75	
1-16392	Sealing Ring	CP022011/150	\$20.40	
1-16387	Back Ring – Dynamic	CP022012/780	\$40.50	

Pump parts

Parts

AccuStream #	Description	Replaces	Price	
1-18269	Quad Ring	9704521/220	\$8.00	
1-16386	Back Ring – Static	CP022015/527	\$27.75	
1-16391	Rod Sealing	XST17/220	\$22.90	
1-18287	Plunger Complete	CP022066/220	\$1,280.00	
1-16389	HP Cylinder	CP022009/779	\$1,060.00	
1-16393	Valve Body	CP022040/591	\$1,170.00	
1-18282	Rod Wear Ring	XF35/220	\$9.60	
1-18281	Union Pressure Side	CP022044/844	\$170.00	
1-18280	Union Suction Side	CP022043/844	\$138.00	
1-18289	Union Pressure Side Complete	CP022047/844	\$535.00	
1-18291	Union Suction Side Complete	CP022109/844	\$489.00	

Repair kits

AccuStream #	Description	Replaces	Price	
1-18293	HP Seal Kit Includes 1 each: bearing bush (1-16388), sealing ring (1-16392), back ring (1-16387), quad ring (1-18269)	CP022100/220	\$107.00	
1-18292	Center Section Rebuild Kit Includes: 1-piston sealing (1-18272), 2-Guide ring (1-18273), 2-O-ring backring 97 (1-18276), 4-rod wear ring (1-18277)		\$186.00	

Replacement parts for Flow

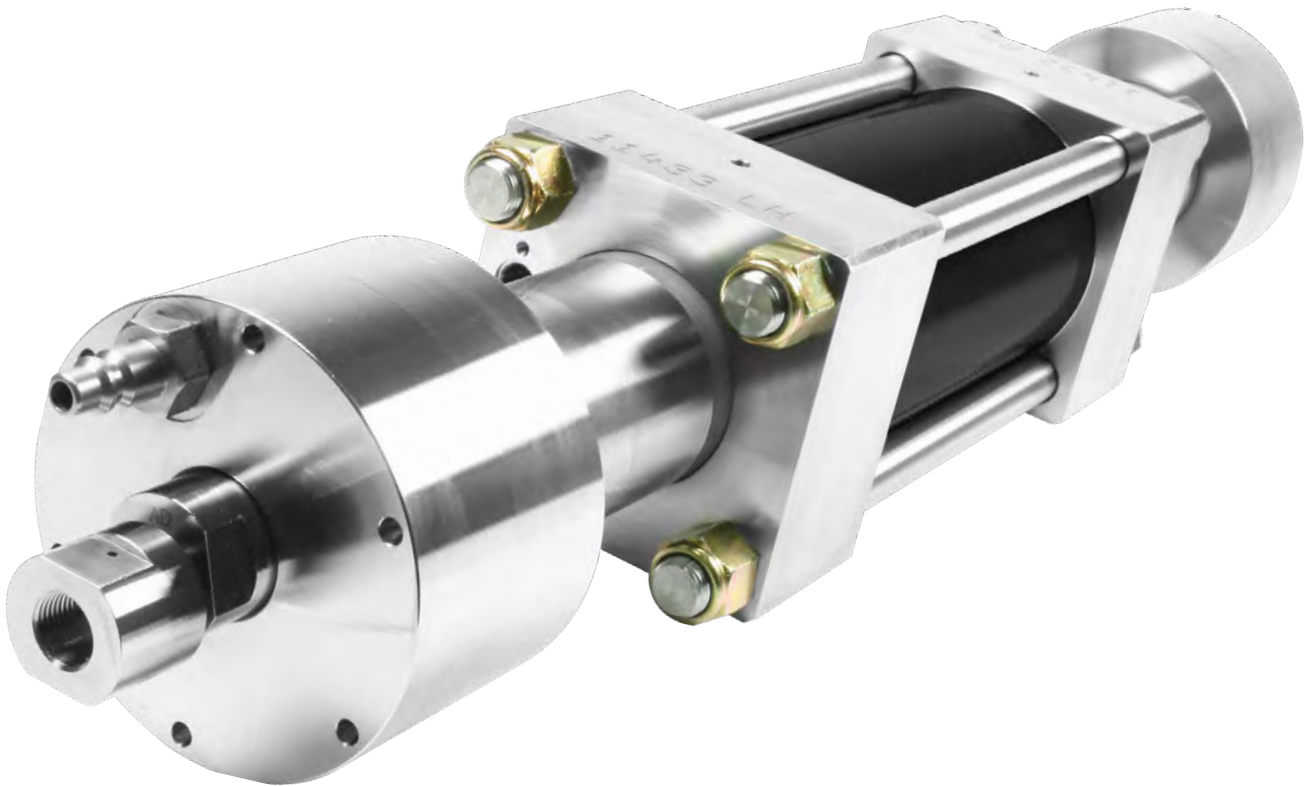

Flow

Orifices

New-style orifices

AccuStream #	Description	Replaces	Price	
1-12498-XXX	Ruby Orifice	014201-XX	\$16.00	
1-12498DA-XXX	Diamond Orifice	014155-XX	\$425.00	
1-12498D-XXX	Diamond Orifice, Water-only	—	\$425.00	
1-22498-XXX	Ultra Sapphire Orifice	014201-XX	\$19.00	

These orifices are compatible with PASER 3 and PASER ECL cutting heads.

PASER 4 orifices

AccuStream #	Description	Replaces	Price	
1-14446-XXX	Ruby Orifice	041759-XX	\$19.00	
1-14447-XXX	Diamond Orifice	015849-XX	\$425.00	
1-24446-XXX	Ultra Sapphire Orifice	041759-XX	\$23.50	

PASER 3 orifices

AccuStream #	Description	Replaces	Price	
1-11226-XXX	Ruby Orifice	009519-XX TL-003002-XX	\$16.00	
1-21226-XXX	Ultra Sapphire Orifice	009519 003002	\$19.00	

PASER 2 orifices

AccuStream #	Description	Replaces	Price	
1-11398-XXX	Ruby Orifice	001821-XX	\$16.00	
1-11398D-XXX	Diamond Orifice	D-5071-XX	\$425.00	
1-21398-XXX	Ultra Sapphire Orifice	001821-XX	\$19.00	

Standard-mount orifices

AccuStream #	Description	Replaces	Price	
1-11238-XXX	Ruby Orifice	004519-XX	\$16.00	
1-11238D-XXX	Diamond Orifice	D-5071-XX	\$425.00	
1-21238-XXX	Ultra Sapphire Orifice	004519-XX	\$19.00	

Low-mass orifices

AccuStream #	Description	Replaces	Price	
1-11462-XXX	Ruby Orifice	003788-XX TL-003003-XX	\$16.00	
1-11462D-XXX	Diamond Orifice	D-5071-XX TL-003004-XX	\$425.00	
1-21462-XXX	Ultra Sapphire Orifice	003788-XX 003003	\$19.00	

-XXX indicates the availability of multiple sizes. Call us or visit AccuStream.com for details.

Mixing tubes (nozzles)

.281 ROCTEC 100 mixing tubes

AccuStream #	Description	Replaces	Price
1-12779-020-20	.281 Mixing Tube, .020 in. × 2.00 in.	012680-20-20	\$75.00
1-12779-020-30	.281 Mixing Tube, .020 in. × 3.00 in.	012680-20-30	\$75.00
1-12779-020-40	.281 Mixing Tube, .020 in. × 4.00 in.	012680-20-40	\$85.00
1-12779-030-30	.281 Mixing Tube, .030 in. × 3.00 in.	012680-30-30	\$75.00
1-12779-030-35	.281 Mixing Tube, .030 in. × 3.50 in.	012680-30-35	\$85.00
1-12779-030-40	.281 Mixing Tube, .030 in. × 4.00 in.	012680-30-40	\$85.00
1-12779-035-30	.281 Mixing Tube, .035 in. × 3.00 in.	012680-35-30	\$75.00
1-12779-035-40	.281 Mixing Tube, .035 in. × 4.00 in.	012680-35-40	\$85.00
1-12779-040-20	.281 Mixing Tube, .040 in. × 2.00 in.	012680-40-20	\$75.00
1-12779-040-30	.281 Mixing Tube, .040 in. × 3.00 in.	012680-40-30	\$75.00
1-12779-040-35	.281 Mixing Tube, .040 in. × 3.50 in.	012680-40-35	\$85.00
1-12779-040-40	.281 Mixing Tube, .040 in. × 4.00 in.	012680-40-40	\$85.00
1-12779-045-30	.281 Mixing Tube, .045 in. × 3.00 in.	012680-45-30	\$75.00
1-12779-050-30	.281 Mixing Tube, .050 in. × 3.00 in.	012680-50-30	\$75.00
1-12779-050-35	.281 Mixing Tube, .050 in. × 3.50 in.	012680-50-35	\$85.00

Interchangeable with DiaLine

.281 ROCTEC 100 mixing tubes with performance locating rings

AccuStream #	Description	Replaces	Price
1-12779-020-30R	.281 Mixing Tube, .020 in. × 3.00 in.	014214-20-30	\$75.00
1-12779-020-40R	.281 Mixing Tube, .020 in. × 4.00 in.	014214-20-40	\$85.00
1-12779-030-30R	.281 Mixing Tube, .030 in. × 3.00 in.	014214-30-30, 1000001-30-30	\$75.00
1-12779-030-40R	.281 Mixing Tube, .030 in. × 4.00 in.	014214-30-40, 1000001-30-40	\$85.00
1-12779-035-30R	.281 Mixing Tube, .035 in. × 3.00 in.	014214-35-30, 1000001-35-30	\$75.00
1-12779-035-40R	.281 Mixing Tube, .035 in. × 4.00 in.	014214-35-40, 1000001-35-40	\$85.00
1-12779-040-30R	.281 Mixing Tube, .040 in. × 3.00 in.	014214-40-30, 1000001-40-30	\$75.00
1-12779-040-40R	.281 Mixing Tube, .040 in. × 4.00 in.	014214-40-40, 1000001-40-40	\$85.00
1-12779-050-30R	.281 Mixing Tube, .050 in. × 3.00 in.	014214-50-30	\$75.00

Flow

Mixing tubes (nozzles)

Not interchangeable with Dialine

.281 ROCTEC 500 mixing tubes

AccuStream #	Description	Replaces	Price
1-11277-020-20	.281 Mixing Tube, .020 in. × 2.00 in.	010460-20-20	\$180.00
1-11277-030-30	.281 Mixing Tube, .030 in. × 3.00 in.	010460-30-30	\$130.00
1-11277-030-40	.281 Mixing Tube, .030 in. × 4.00 in.	010460-30-40	\$140.00
1-11277-035-30	.281 Mixing Tube, .035 in. × 3.00 in.	010460-35-30	\$130.00
1-11277-035-40	.281 Mixing Tube, .035 in. × 4.00 in.	010460-35-40	\$140.00
1-11277-040-30	.281 Mixing Tube, .040 in. × 3.00 in.	010460-40-30	\$130.00
1-11277-040-40	.281 Mixing Tube, .040 in. × 4.00 in.	010460-40-40	\$140.00
1-11277-045-30	.281 Mixing Tube, .045 in. × 3.00 in.	010460-45-30	\$130.00
1-11277-050-30	.281 Mixing Tube, .050 in. × 3.00 in.	010460-50-30	\$130.00
1-11277-050-40	.281 Mixing Tube, .050 in. × 4.00 in.	010460-50-40	\$140.00

Interchangeable with Dialine

.281 ROCTEC 500 mixing tubes with performance locating rings







AccuStream #	Description	Replaces	Price
1-11277-030-30R	.281 Mixing Tube, .030 in. × 3.00 in.	014194-30-30, 1000003-30-30	\$130.00
1-11277-030-40R	.281 Mixing Tube, .030 in. × 4.00 in.	014194-30-40, 1000003-30-40	\$140.00
1-11277-035-30R	.281 Mixing Tube, .035 in. × 3.00 in.	014194-35-30, 1000003-35-30	\$130.00
1-11277-035-40R	.281 Mixing Tube, .035 in. × 4.00 in.	014194-35-40, 1000003-35-40	\$140.00
1-11277-040-30R	.281 Mixing Tube, .040 in. × 3.00 in.	014194-40-30, 1000003-40-30	\$130.00
1-11277-040-40R	.281 Mixing Tube, .040 in. × 4.00 in.	014194-40-40, 1000003-40-40	\$140.00
1-11277-050-40R	.281 Mixing Tube, .050 in. × 4.00 in.	014194-50-40, 1000003-50-40	\$140.00

Not interchangeable with Dialine

Cutting heads



PASER 3 cutting heads

Replacement parts









AccuStream #	Description	Replaces	Price	
1-11465	Abrasive Nozzle Clamp, 60K, PASER 3	009939-1	\$47.75	
1-12765	Mixing Chamber, Single-inlet, 60K, PASER 3 Use with 1-11465 Abrasive Nozzle Clamp and 1-11357 Retainer Collet.	—	\$214.00	
1-12249	Mixing Chamber, Dual-inlet, 60K, PASER 3 Use with 1-11465 Abrasive Nozzle Clamp and 1-11357 Retainer Collet.	009940-2 TL-002005-1	\$234.00	
1-11357	Retainer Collet, PASER 3	009941-1	\$8.20	
1-12894	Rubber Bumper, 60K, PASER 3 Use with the abrasive metering valve.	A-11073	\$2.20	
1-13991	On/off Mounting Collar, 60K, PASER 3	006144-1	\$120.00	
1-14495	Abrasive Inlet Cap	A-11080	\$1.10	

PASER 4 cutting heads

Assemblies

AccuStream #	Description	Replaces	Price	
1-14525	Cutting Head Assembly, PASER 4	041136-1	\$860.00	
1-18741	Dialine4 Complete Assembly Direct replacement for Paser4 requiring no additional adapters	041136-1	\$745.00	

Replacement parts



AccuStream #	Description	Replaces	Price	
1-14467	Mixing Tube Space, PASER 4 / PASER® ECL	712265-1	\$18.10	
1-14466	Precision Collet, PASER 4	A-23161-8	\$85.00	
1-14464	Knurled Nut, New Style, PASER 4	711589-1	\$111.00	
1-14468	Mixing Chamber, PASER 4	041138-1	\$470.00	
1-14465	Blast Disk, New Style, PASER 4	711933-1	\$6.20	
1-14469	V-ring Seal, PASER 4	A-22752-11	\$3.40	
1-14495	Abrasive Inlet Cap	A-11080	\$1.10	
1-18717	Nozzle Splash Guard	711621-1 040411-1	\$16.00	

Flow









Cutting heads

DiaLine cutting heads

Assemblies

AccuStream #	Description	Price	
1-12905	DiaLine Cutting Head Assembly, Clamp The clamp DiaLine is a cutting head upgrade.	\$725.00	
1-18741	Dialine4 Complete Assembly Direct replacement for Paser4 requiring no additional adapters	041136-1 \$745.00	

Replacement parts

AccuStream #	Description	Replaces	Price	
1-12884	DiaLine Nozzle Nut, Clamp Style	—	\$135.00	
1-11357	Retainer Collet	009941-1	\$8.20	
1-12747	DiaLine Carbide Mixing Chamber	—	\$177.00	
1-12752	DiaLine Inlet Connector, 3/8 in.	—	\$27.50	
1-11679-012	DiaLine Inlet O-ring, -012	—	\$1.55	
1-11679-216	DiaLine O-ring, -216	—	\$1.55	
1-12836	DiaLine Set Screw	—	\$1.70	
1-14495	Abrasive Inlet Cap	A-11080	\$1.10	
1-12860	Dialine Nozzle Body, Clamp, 4.275 in.	—	\$310.00	













Cutting heads

XD cutting head

Assemblies

AccuStream #	Description	Replaces	Price	
1-19158	XD Cutting Head Assembly	045160-2	\$3,425.00	

XD cutting head replacement parts

AccuStream #	Description	Replaces	Price	
1-12662-006	O-ring, -006 Red	—	\$2.25	
1-13424	90K Universal On/Off Valve Body	014554-1	\$304.00	
1-13425	Universal On/off Valve Needle Guide Backup ring	014555-1	\$30.25	
1-13426	Universal On/off Valve Needle Poppet	014557-1	\$84.00	
1-13427	Universal On/off Valve Poppet Seat	014558-1	\$42.25	
1-14369	Antivibration Assembly, 1/4 in.	—	\$73.00	
1-14464	Knurled Nut, New Style, PASER 4	711589-1	\$111.00	
1-14465	Blast Disk, New Style, PASER 4	711933-1	\$6.20	
1-14466	Precision Collet, PASER 4	A-23161-8	\$85.00	
1-14467	Mixing Tube Space, PASER 4 / PASER ECL	712265-1	\$18.10	
1-14468	Mixing Chamber, PASER 4	041138-1	\$470.00	
1-14469	V-ring Seal, PASER 4	A-22752-11	\$3.40	
1-14540	Universal Actuator Assembly	014559-1	\$820.00	
1-17526	Adapter, Nozzle Body	044837-1	\$439.00	
1-17527	90° On/off Valve Adapter	044866-1	\$406.00	
1-17529	Collar On/off Valve	710867-1	\$31.25	
1-17530	Collar Nozzle Body	710869-1	\$56.50	
1-18717	Nozzle Splash Guard	040411-1	\$16.00	
1-11679-014	O-ring, -014	A-0275-014	\$1.55	



Flow

Nozzle tubes (nozzle bodies)

Replacement parts

AccuStream #	Description	Replaces	Price	
1-14164	Mini Precision Nozzle Body, 4.00 in.	017257-1	\$206.00	
1-13431	Nozzle Body, 4.00 in. Use with 94K cutting heads.	019519-1	\$339.00	
1-11358-4	Adapter, DiaLine to Flow Short nozzle body, 4.330 in.	001995-1 TL-002001-1	\$253.00	
1-14463	PASER4 Nozzle Body, 4.330 in. Use with 60K or 94K cutting heads.	041137-1	\$253.00	
1-14222	Swivel Adapter Assembly, 4.330 in.	—	\$320.00	
1-11490	Nozzle Body, New Style, 4.332 in.	014196-1	\$204.00	
1-11389	Insta 2 Nozzle Body, 4.342 in.	003828-1	\$414.00	
1-14158	Low-mass Nozzle Body, 5.490 in. Use with 1-13406 Low-mass Nozzle Orifice Retainer.	006145-1 TL-002003-1	\$297.00	
1-14448	H2O Nozzle Body, 5.505 in. Use with 1-14516 H2O Orifice Retainer.	100037-1	\$320.00	
1-11463	Extended-length Low-mass Nozzle Body, 7.697 in. Use with 1-13406 Low-mass Nozzle Orifice Retainer.	—	\$443.00	
1-11358-8	Long Nozzle Body, 8.110 in.	001995-2 TL-002001-2	\$353.00	

Nozzle orifice retainers

AccuStream #	Description	Replaces	Price	
1-11299	Nozzle Nut Retainer, PASER 3	B-1041-1 TL-002002-1	\$65.00	
1-13406	Low-mass Nozzle Orifice Retainer Use with 1-11463 Extended Low-mass Nozzle Body and 1-14158 Low-mass Nozzle Body.	006146-1	\$62.50	
1-14516	H2O Orifice Retainer Use with 1-14448 H2O Nozzle Body.	B-5330-1	\$120.00	

Looking for orifices? See page 24.





On/off valves

Insta 1 on/off valves

Repair kits





AccuStream #	Description	Replaces	Price	
1-11146	Insta 1 and H2O On/off Valve Repair Kit Use with 1-11142 Insta 1 Valve Seal and 1-13380 H2O Pneumatic Valve Body. Includes poppet seat, seal backup ring, valve seal, on/off valve O-ring, poppet stem	001959-1 302001-1 TL-004001-1	\$90.00	
1-13685	Insta 1 High-cycle On/off Valve Repair Kit Includes poppet seat, seal backup ring, valve seal, on/off valve O-ring, high-cycle poppet stem	—	\$202.00	

Assemblies

AccuStream #	Description	Price	
1-14373-1-1	Insta 1 On/off Valve Assembly Includes nozzle body	\$1,020.00	
1-14373-1-2	Insta 1 On/off Valve Assembly Includes swivel adapter assembly	\$1,080.00	
1-14373-1-3	Insta 1 On/off Valve Assembly Includes low-mass nozzle body	\$1,140.00	
1-14373-1-4	Insta 1 On/off Valve Assembly Includes new-style nozzle body	\$1,050.00	

Looking for swivel adapters? See page 29.

Replacement parts



AccuStream #	Description	Replaces	Price	
1-11144	Insta 1 Valve Body	006143-1 TL-004006-1	\$229.00	
1-11140	Insta 1 Nozzle Poppet Stem	006934-1 TL-004002-1	\$73.00	
1-11141	Insta 1 and Insta 2 Poppet Seat	006933-1 TL-004003-1	\$25.50	
1-11142	Insta 1 Valve Seal	001328-1 TL-004004-1	\$11.20	
1-11143	Insta 1 Bronze Backup Ring	001337-1 TL-004005-1	\$13.10	
1-11679-014	O-ring, -014	A-0275-014	\$1.55	
1-11218	Insta 1 Valve Screw (Retainer Cap)	001112-1 TL-004007-1	\$36.25	
1-12128	Insta 1 Air Actuator, Normally Closed	001323-1 TL-004018-1	\$477.00	
1-11394	Adapter, 3/8-in. Male to 1/4-in. Female	—	\$76.00	

Flow

On/off valves

Insta 2 on/off valves

Repair kits

AccuStream #	Description	Replaces	Price	
1-11279	Insta 2 On/off Valve Repair Kit Includes poppet, backup ring, poppet seat, on/off valve O-ring, on/off seal	010200-1 TL-004010-1	\$109.00	
1-13687	Insta 2 High-cycle On/off Valve Repair Kit Includes poppet, backup ring, poppet seat, O-ring seals	—	\$236.00	

Assemblies

AccuStream #	Description	Price	
1-14373-2-1	Insta 2 On/off Valve Assembly Includes nozzle body	\$1,150.00	
1-14373-2-2	Insta 2 On/off Valve Assembly Includes swivel adapter	\$1,210.00	
1-14373-2-3	Insta 2 On/off Valve Assembly Includes low-mass nozzle body	\$1,140.00	
1-14373-2-4	Insta 2 On/off Valve Assembly Use with 1-11463 Extended-length Low-mass Nozzle Body and 1-14158 Low-mass Nozzle Body.	\$1,050.00	

Looking for swivel adapters? See page 29..

Replacement parts

AccuStream #	Description	Replaces	Price	
1-11272	Insta 2 Valve Body	010104-1 TL-004016-1	\$281.00	
1-11387	Insta 2 Nozzle Poppet Stem	—	\$209.00	
1-11275	Insta 2 Poppet Needle	010105-1 TL-004011-1	\$43.50	
1-13686	Insta 2 Poppet Needle, High-cycle	—	\$96.00	
1-11141	Insta 1 and Insta 2 Poppet Seat	006933-1 TL-004003-1	\$25.50	
1-11276	Insta 2 Valve Seal	003831-1 TL-004015-1	\$12.90	
1-11274	Insta 2 Bronze Backup Ring	003832-1 TL-004012-1	\$36.00	
1-11273	Insta 2 Bushing Stem	003838-1 TL-004013-1	\$22.50	
1-11679-014	O-ring, -014	A-0275-014	\$1.55	
1-13049	Insta 2 Retainer	004096-1	\$77.00	
1-12129	Insta 2 Air Actuator, Normally Closed	003840-1 TL-004017-1	\$477.00	
1-11394	Adapter, 3/8-in. Male to 1/4-in. Female	—	\$76.00	



On/off valves

Mini on/off valves

Mini On/Off Assemblies

AccuStream #	Description	Replaces	Price	
1-19575	Mini Actuator Assembly	710870-1	\$1,320.00	
1-19388	Mini Actuator	710875-1	\$585.00	

Repair kits

AccuStream #	Description	Replaces	Price	
1-12544	Mini On/off Valve Repair Kit Includes poppet, poppet seat, dynamic seal, backup ring, bushing, O-ring	711484-1	\$107.00	
1-18708	Mini On/off Valve Repair Kit, High-Cycle Includes poppet, poppet seat, dynamic seal, back up ring, bushing, O-ring	711484-1	\$229.00	

Replacement parts

AccuStream #	Description	Replaces	Price	
1-12538	Mini Valve Body	710866-1	\$268.00	
1-12539	Mini Poppet	710822-1	\$46.00	
1-12543	Mini Poppet Seat	710823-1	\$26.25	
1-12541	Mini Dynamic Seal	710820-1	\$25.50	
1-12540	Mini Bronze Backup Ring	710819-1	\$24.00	
1-12542	Mini Bronze Bushing	710821-1	\$36.50	
1-11679-014	O-ring, -014	A-0275-014	\$1.55	
1-19572	Push Lock Elbow Fitting	A-15083-5	\$49.00	
1-19574	Mini Collar	710868-1	\$61.50	
1-17529	Retaining Collar	710867-1	\$31.25	
1-13495	Anti-Vibration Assembly	—	\$35.75	

Flow

On/off valves

Universal on/off valves (60K and 94K)







Repair kits

AccuStream #	Description	Replaces	Price	
1-13429	Universal On/off Valve Repair Kit Includes 13430 Universal On/off Valve Seal Assembly, needle guide, needle, seat, O-ring	014988-1	\$167.00	

Assemblies

AccuStream #	Description	Replaces	Price	
1-14540	Universal Actuator Assembly	014559-1	\$820.00	

Replacement parts





AccuStream #	Description	Replaces	Price	
1-13424	90K Universal On/Off Valve Body	014554-1	\$304.00	
1-13425	Universal On/off Valve Needle Guide Backup ring	014555-1	\$30.25	
1-13430	Universal On/off Valve Seal Assembly (94K)	014556-1	\$17.70	
1-13426	Universal On/off Valve Needle Poppet	014557-1	\$84.00	
1-13427	Universal On/off Valve Poppet Seat	014558-1	\$42.25	
1-11679-014	O-ring, -014	A-0275-014	\$1.55	

H2O high-performance on/off valve

Repair kits





AccuStream #	Description	Replaces	Price	
1-11146	Insta 1 and H ₂ O On/off Valve Repair Kit Includes poppet seat, seal backup ring, valve seal, on/off valve, poppet stem, O-ring	001959-1 302001-1 TL-004001-1	\$90.00	

Replacement parts



AccuStream #	Description	Replaces	Price	
1-13380	H ₂ O Pneumatic Valve Body	100048-1	\$240.00	
1-13685	Insta 1 High-cycle On/off Valve Repair Kit Includes poppet seat, seal backup ring, valve seal, on/off valve O-ring, high-cycle poppet stem	—	\$202.00	
1-14445	Insta Hybrid Air Actuator, High-performance, Normally Closed	301006-1	\$477.00	
1-13716	Retainer Insert Assembly, H ₂ O High-performance	301008-1	\$98.00	

60K Pump parts

Repair kits: Seals

AccuStream #	Description	Replaces	Price	
1-11135	Seal Repair Kit with Bronze Backups Includes hoops, seals, bronze backups	001198-1 TL-001001-1	\$129.00	
1-11467	Seal Repair Kit without Backups Includes hoops, seals	—	\$107.00	
1-11281	Low-pressure Seal Repair Kit, ESL Includes spring-energized rod seal	010641-1 TL-001006-1	\$80.00	
1-11286	Low-pressure Seal Repair Kit Does not include spring-energized rod seal	B-1163-1 TL-001021-1	\$60.50	

Repair kits: Check valves

AccuStream #	Description	Replaces	Price	
1-11282	Check Valve Repair Kit Includes outlet poppet, inlet poppet, insert, inlet poppet housing, retaining screw, poppet spring, O-rings	015866-1 010642-1 TL-001004-1	\$95.00	
1-12656	Check Valve Repair Kit, Hybrid Flow/KMT, Calypso; includes inlet poppet, insert, inlet poppet housing, retaining screw, high-pressure poppet guide, check valve poppet, poppet compression spring, O-ring	302003-2	\$152.00	













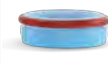

Repair kits: Bleed-down and blow-down valves

AccuStream #	Description	Replaces	Price	
1-11331	Bleed-down Valve Repair Kit Includes seat, needle, bushing, high-pressure seal, seal hoop, oil seal, backup, O-rings	004694-1 TL-001009-1	\$90.00	

Flow



















60K Pump parts

Replacement parts

AccuStream #	Description	Replaces	Price	
1-11570	Short Block Intensifier Assembly	010558-3	\$9,250.00	
1-12776	Short Block Intensifier Assembly Includes 1-12349 HyLoad Hydraulic Piston	—	\$9,250.00	
1-12362	Short Block Intensifier Assembly Includes 1-12349 HyLoad Hydraulic Piston, and Hybrid check valves	—	\$9,500.00	
1-12246	Long Block Intensifier Assembly, Performance Electronic negative-positive-negative shifting	—	\$11,800.00	
1-11595	Attenuator Assembly, 2-liter Installation drawing available on request	—	\$12,000.00	
1-12280	Attenuator Assembly, 1-liter Installation drawing available on request	—	\$6,750.00	
1-12340	Spring-energized Rod Seal	A-11275	\$18.30	
1-11076	Seal Assembly Includes O-ring	004406-1 TL-001015-1	\$16.90	
1-11077	Hoop Use with 1-11076 Seal.	004407-1 TL-001014-1	\$14.60	
1-11134	Bronze Seal Backup	B-1465-1 TL-001019-1	\$36.00	
1-11365	Backup Seal Sleeve	B-1002-2 TL-001018-1	\$92.00	
1-11468	Spacer Oil Seal	010276-1 TL-001027-1	\$13.50	
1-11421	Check Valve Assembly	010559-3	\$585.00	
1-11115	Check Valve Body	004383-3 TL-001003-3	\$320.00	
1-11231	Outlet Body	C-1313-1 TL-001007-1	\$185.00	
1-11228	Outlet Poppet	005917-1 TL-001016-1	\$22.30	

60K Pump parts





Replacement parts

AccuStream #	Description	Replaces	Price	
1-14178	Poppet Seat	—	\$41.50	
1-11234	Poppet Spring	A-1606	\$3.40	
1-11233	Retaining Screw	004380-1 TL-001026-1	\$20.80	
1-12363	Output Adapter, Hybrid Flow/KMT, Calypso	100022-2 TL-001024-1	\$208.00	
1-11229	Inlet Poppet	015384-1 010011-1	\$11.60	
1-11232	Inlet Poppet Housing	010564-1 TL-001022-1	\$33.75	
1-11230	Insert	004382-1 TL-001017-1	\$22.50	
1-11679-125	Check Valve O-ring, -125	A-0275-125	\$1.55	
1-11679-131	Check Valve O-ring (94K)	A-0275-131	\$1.55	
1-11480	Bleed-down Valve Assembly	C-5841-1 TL-001011-1	\$900.00	
1-11594	Bleed-down Valve Body	001822-1 C-1000-1 TL-001033-1	\$248.00	
1-11321	Bleed-down Valve Seal	—	\$14.20	
1-11742	Bleed-down Valve Output Adapter	B-5975-1	\$142.00	
1-11780	High-pressure Collar	B-5078-1	\$99.00	
1-11680-114	Backup Ring, -114	—	\$1.55	
1-11778	Bleed-down Valve Piston	B-8428-1	\$36.50	
1-11322	Bleed-down Valve Stem Needle	—	\$30.25	
1-11323	Bleed-down Valve Seal Hoop	—	\$10.10	
1-11324	Bleed-down Valve Stem Bushing	—	\$18.00	

Flow



















60K Pump parts

Replacement parts

AccuStream #	Description	Replaces	Price	
1-11325	Bleed-down Valve High-pressure Seat	—	\$47.75	
1-11359	Bleed-down Valve Oil Seal	—	\$9.20	
1-11679-114	O-ring, -114	—	\$1.55	
1-12880-908	O-ring, SAE Fitting	—	\$1.15	
1-12880-912	O-ring, SAE Fitting	—	\$1.15	
1-11743	Bleed-down Valve Flow Reducer	B-8426-1	\$29.25	
1-11779	Bleed-down Valve Housing Body	B-8427-1	\$288.00	
1-11796	Hydraulic Adapter, Male to Female	—	\$9.00	
1-11117	High-pressure Cylinder	007038-3 TL-001002-3	\$670.00	
1-11284	Low-pressure Cylinder with Chrome-plated ID Use with AccuStream 1-11438 Hydraulic Piston.	C-1000-1 TL-001012-1	\$225.00	
1-11438	Hydraulic Piston	007026-1 TL-001013-1	\$337.00	
1-12599	Low-pressure Cylinder ID is not chrome plated. Use with AccuStream 1-12349 HyLoad Hydraulic Piston.	—	\$166.00	
1-12349	HyLoad Hydraulic Piston Includes capped T piston seal, wear rings, hydraulic piston	TL-001013-1	\$645.00	
1-12386	Piston Seal Kit Use with 1-12349 HyLoad Hydraulic Piston.	—	\$80.00	
1-13706	Piston Seal Tool, 4.0 in. diameter	—	\$222.00	
1-13718	Piston Installation Tool, 4.0 in. diameter	—	\$273.00	
1-11422	Retrofit Kit to ESL Includes 1-11309 Ceramic Plungers, 1-11135 Seal Repair Kit, 1-11282 Check Valve Repair Kits	010281-1	\$2,460.00	
1-11309	Ceramic Plunger, .875 in. (60K & 94K)	010253-1 TL-001005-1	\$1,040.00	
1-11446	Piston Assembly Includes piston, ceramic plungers, plunger retainers, snap rings, T-seals	010561-1	\$2,460.00	

60K Pump parts







Replacement parts

AccuStream #	Description	Replaces	Price	
1-11437	Plunger Retainer	007029-1	\$61.50	
1-12364	Wear Ring	—	\$5.20	
1-12371	Piston Snap Ring	A-0270-250	\$3.70	
1-11680-240	Backup Ring, -240	—	\$2.30	
1-12378	Actuator Assembly, Electronic Shift	B-8346-1	\$146.00	
1-12357	Sensor Assembly, Electronic Shift Negative-positive-negative shifting, normally open	011275-1	\$261.00	
1-11733	Electrical Shift and Pilot Assembly 24-volt Rexroth	A-18862	\$1,480.00	
1-12684	Electrical Shift Valve and Pilot Assembly 24-volt Vickers	C-2743-1	\$1,470.00	
1-11736	Pilot Valve, 24-volt Electrical	A-10544	\$635.00	
1-11469	Firing Pin, Mechanical Shift	002226-1	\$16.90	
1-11470	Firing Pin, Electrical Shift	B-1702-1	\$29.25	
1-12724	Actuating Plunger	B-1007-1	\$66.50	
1-11420	High-pressure End Cap	321276-1 TL-001010-1	\$690.00	
1-11432	End Bell, Right	007303-1 TL-001008-1	\$1,550.00	
1-11433	End Bell, Left	007303-2 TL-001008-2	\$1,550.00	
1-12974	Guide Bushing, End Bell	B-1040-2	\$18.00	
1-11471	Tie Rod	B-1000-2	\$56.50	
1-11472	Hex Nut	A-1000	\$3.40	

Flow





60K Pump parts

Replacement parts







AccuStream #	Description	Replaces	Price	
1-13006	Hydraulic Manifold, Top-mount	—	\$620.00	
1-12177	Hydraulic Manifold, Side-mount Includes relief valve	013403-1	\$1,180.00	
1-12801	Mechanical Shift Guide Cable, Left	C-5462-1	\$365.00	
1-12802	Mechanical Shift Guide Cable, Right	C-5461-1	\$365.00	
1-12725	Shifting Split Pin	B-1611-1	\$39.25	
1-12791	Compression Spring, Inner	A-1713	\$7.30	
1-12792	Compression Spring, Outer	A-1012	\$6.80	

Flow Hyplex

Kits

AccuStream #	Description	Replaces	Price	
1-18973	Hyplex Prime Minor Kit	050624-1	\$615.00	
1-18976	Hyplex Prime Major Kit	050624-2	\$3,300.00	
1-18975	Hyplex Prime Dynamic Seal Kit	050626-1	\$80.00	
1-19053	Hyplex Prime Major Kit – no plungers	—	\$2,650.00	

Replacement parts

AccuStream #	Description	Replaces	Price	
1-11210-30	600 Grit Lapping Paper	A-1903, 10149029	\$3.45	
1-11447	High Vacuum Grease, 5G	A-4689, 10087385	\$1.70	
1-11679-025	O-ring, -025	A-0275-025, 10074383	\$1.55	
1-11679-029	O-ring, -029	A-0275-029, 5122007	\$1.55	
1-11679-033	O-ring, -033	A-0275-033, 204334082	\$5.30	
1-11993	U-cup Seal	A-00720-31, 72185208	\$2.85	

Pump parts

Flow Hplex

Replacement parts





AccuStream #	Description	Replaces	Price	
1-18745	5/8" Retaining Ring	A-0265-062, 72185226	\$13.80	
1-18747	Spring, 352 ID	A-12219, 72185141	\$7.50	
1-18748	Spring, 362 ID	A-12217, 72186948	\$5.30	
1-18749	Rod Seal, Disogrin	A-00621-33, 72185125	\$9.10	
1-18750	Anti-Seize, 7G	A-20386-1, 49832199	\$5.90	
1-18752	Spring, 322 OD	A-9223, 72185200	\$4.00	
1-18753	Spring, 336 ID	A-12218, 72186940	\$6.40	
1-18861	Check Valve Body	049578-1, 72185307	\$478.00	
1-18862	Dynamic Seal	011051-1, 72185177	\$26.75	
1-18863	Filler Tube	011050-1	\$85.00	
1-18864	Filler Tube Sleeve	011350-1, 72185149	\$7.50	
1-18865	Inlet Poppet	011042-1, 72185133	\$18.10	
1-18867	Outlet Poppet Seat	011041-1, 72185192	\$53.50	
1-18868	Outlet Poppet Guide	011040-1, 72185167	\$10.70	
1-18869	Outlet Poppet	011039-1, 72185185	\$10.70	
1-18870	Outlet Cage	006732-1	\$103.00	
1-18872	HP Cylinder	049584-1, 72185325	\$345.00	
1-18875	Seal Carrier Assembly	044099-1, 72185291	\$186.00	
1-18882	PCV Assembly	042145-2, 72185250, 72185258, 72185276	\$212.00	
1-18883	Ceramic Plunger Assembly	011045-1, 72186914	\$560.00	
1-18974	Check Valve Assembly	049603-1	\$520.00	

Flow









Pump parts

Flow 87k

Kits

AccuStream #	Description	Replaces	Price	
1-14523	Low-pressure Seal Repair Kit	013157-1	\$107.00	
1-14522	Check Valve Repair Kit Includes inlet poppet, poppet housing, retaining screw, poppet spring, high-pressure poppet, poppet seat, O-ring	012035-1	\$152.00	
1-14519	Inlet Repair Kit Includes inlet poppet, poppet housing, retaining screw	014884-1	\$62.50	
1-14521	Outlet Repair Kit Includes high-pressure poppet, poppet seat, poppet spring	014885-1	\$152.00	
1-14524	Blow-down Repair Kit Includes poppet, bearings, backup rings, seat, seal, O-rings	015084-1	\$197.00	









Replacement parts

AccuStream #	Description	Replaces	Price	
1-19380	Check Valve Assembly	020071-1	\$700.00	
1-14176	Check Valve Body	020077-1	\$505.00	
1-14179	Output Adapter	042101-1	\$92.00	
1-11229	Inlet Poppet	015384-1, 10011-1	\$11.60	
1-11232	Inlet Poppet Housing	010564-1, TL-001022-1	\$33.75	
1-11233	Retaining Screw	004380-1	\$20.80	
1-11234	Poppet Spring	A-1606	\$3.40	
1-11679-131	Check Valve O-ring	A-0275-131	\$1.55	
1-14177	HP Poppet	011309-1	\$45.00	
1-14178	Poppet Seat	014388-1	\$41.50	
1-11679-212	O-ring, -212		\$1.55	
1-12880-908	O-ring, SAE Fitting		\$1.15	
1-14175	HP Cylinder	020592-1	\$915.00	



Pump parts

Flow 87k



Replacement parts

AccuStream #	Description	Replaces	Price	
1-11679-212	O-ring, -212		\$1.55	
1-12880-908	O-ring, SAE Fitting		\$1.15	
1-19488	Hyload Piston Assembly Includes 2 wear rings, 2 small t-seals, 1 Piston T-Seal Requires the piston installation tool 1-19595	020080-1	\$900.00	
1-19489	Hyload Piston Assembly with Plungers Requires the piston installation tool 1-19595	020079-1	\$3,000.00	
1-19584	Piston Seal Kit Includes 2 wear rings, 2 small t-seals, 1 Piston T-Seal Requires the piston installation tool 1-19595 and piston seal tool 1-19596		\$95.00	
1-13356	Filler Tube Assembly	020595-1	\$215.00	
1-11309	Plunger	010253-1 TL-001005-1	\$1,040.00	
1-12357	Electronic Shift Sensor Assembly	011275-1	\$261.00	
1-12378	Actuator Assembly, Electronic Shift	B-8346-1	\$146.00	
1-12340	Rod Seal	A-11275	\$18.30	
1-12371	Piston Snap Ring	A-0270-300	\$3.70	

Swivels

AccuStream #	Description	Replaces	Price	
1-14444	90° Swivel Assembly 1/4 in., 100k	014922-1	\$2,080.00	
1-14493	90° Swivel Repair Kit, 1/4 in., 100k	015093-1	\$810.00	



87k Tools

AccuStream #	Description	Replaces	Price	
1-19595	Piston Installation Tool		\$275.00	
1-19596	Piston Seal Installation Tool		\$295.00	

Flow

Pump parts

Filters

AccuStream #	Description	Replaces	Price	
1-11402	Water Filter Cartridge, 0.45 micron, 10 in.	A-1449, 72185076	\$40.50	
1-11390	Water Filter Cartridge, 1.0 micron, 10 in.	A-1555, 72185083	\$41.00	
1-12738	60ksi Hydraulic Filter	A-5480	\$157.00	

Replacement parts for Jet Edge



Jet Edge

Orifices

Permalign II orifices

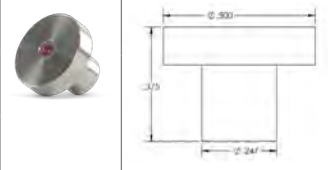
AccuStream #	Description	Replaces	Price	
1-11267-XXX	Ruby Orifice	100159-XXX	\$16.00	
1-11267D-XXX	Diamond Orifice	100158-XXX	\$450.00	
1-21267-XXX	Ultra Sapphire Orifice	100159	\$19.00	

Threaded orifices

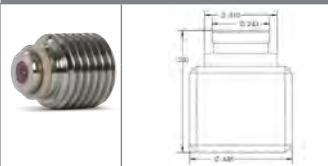
AccuStream #	Description	Replaces	Price	
1-11417-XXX	Ruby Orifice	36874-XXX	\$20.00	
1-21417-XXX	Ultra Sapphire Orifice	36874-XXX	\$21.00	

-XXX indicates the availability of multiple sizes. Call us or visit AccuStream.com for details.

Nozzles





.250 ROCTEC® 100 nozzles

AccuStream #	Description	Replaces	Price	
1-12782-020-30	.250 Nozzle, .020 in. × 3.00 in.	—	\$75.00	
1-12782-030-30	.250 Nozzle, .030 in. × 3.00 in.	30647 36937	\$75.00	
1-12782-035-30	.250 Nozzle, .035 in. × 3.00 in.	—	\$75.00	
1-12782-040-30	.250 Nozzle, .040 in. × 3.00 in.	30648 101159	\$75.00	
1-12782-045-30	.250 Nozzle, .045 in. × 3.00 in.	30649 36769	\$75.00	
1-12782-050-30	.250 Nozzle, .050 in. × 3.00 in.	—	\$75.00	

Other sizes are available on request.



Cutting heads

Permalign II cutting heads









AccuStream #	Description	Replaces	Price	
1-11391	Mixing Chamber	100155	\$88.00	
1-11361	Nozzle Splash Guard, Rubber	29683	\$7.10	
1-11362	Nozzle Splash Guard, Carbide	29683	\$77.00	

On/off valves

Repair kits

AccuStream #	Description	Replaces	Price	
1-13877	On/off Valve Repair Kit, High Cycle Includes seat, high-cycle straight needle, needle guide, valve seal	—	\$163.00	
1-11369	On/off Valve Repair Kit, Old Style Includes seat, old needle, old needle bearing, valve seal	—	\$69.50	
1-12208	OmniJet III Repair Kit Includes seat, straight needle, new needle bearing, valve seal	104497	\$86.00	

Replacement parts

AccuStream #	Description	Replaces	Price	
1-11055	On/off Valve Body	46627	\$138.00	
1-11394	On/off Valve Adapter, 1/4-in. Female to 3/8-in. Male	—	\$76.00	
1-11043	On/off Valve Seal	37135	\$15.60	
1-11562	On/off Valve Needle, New Style	101843	\$36.00	
1-16178	On/off Valve Needle Bearing, New Style Use with 1-11562 New-style On/off Valve Needle.	37136	\$36.50	
1-11041	On/off Valve Needle, Old Style	29107	\$19.50	
1-11042	On/off Valve Needle Bearing, Old Style Use with 1-11041 Old-style On/off Valve Needle.	—	\$23.50	
1-11289	On/off Valve Seat	36826	\$16.00	

Jet Edge



Pump parts

7/8 inch



Repair kits: Seals

AccuStream #	Description	Price	
1-11449	Seal Repair Kit, 7/8 in. Includes seal, hoop, high-vacuum grease	\$109.00	

Repair kits: Check valves

AccuStream #	Description	Price	
1-12851	Check Valve Repair Kit, New Style, 7/8 in. Includes low-pressure poppet, high-pressure poppet, poppet spring, poppet seat housing	\$126.00	
1-11450	Check Valve Repair Kit, Old Style, 7/8 in. Includes low-pressure poppet, high-pressure poppet, poppet spring, seat	\$61.50	

Replacement parts

AccuStream #	Description	Replaces	Price	
1-11252	Backup Disk Kit, 7/8 in. Includes seal assembly, bronze backup housing, backup disk, hoop, rod seal, O-rings	102419	\$221.00	
1-11076	Seal, 7/8 in. Includes O-ring	35373	\$16.90	
1-11077	Hoop, 7/8 in. Use with 1-11076 Seal.	35364	\$14.60	
1-11250	Backup Disk, 7/8 in.	101912	\$40.25	
1-11246	Backup Ring, 7/8 in.	101911	\$156.00	
1-11118	Hydraulic Rod Seal, 7/8 in.	25954	\$6.90	
1-11091	O-ring Backup, 7/8 in.	26471	\$1.15	
1-11092	O-ring Backup, 7/8 in.	26472	\$1.15	
1-11132	Bearing, 7/8 in.	35568	\$343.00	

Pump parts

7/8 inch

Replacement parts



AccuStream #	Description	Replaces	Price	
1-11123	High-pressure Cylinder, 7/8 in.	45395	\$920.00	
1-11679-044	Cylinder O-ring, 7/8 in.	25947	\$1.55	
1-12853	Check Tube Assembly, 7/8 in. Includes check tube, low-pressure poppet, poppet housing	105026	\$655.00	
1-12807	Check Tube, New Style, 7/8 in.	104877	\$600.00	
1-14527	Check Tube, iP Pump, 7/8 in.	104048	\$600.00	
1-12770	Check Tube Outlet Body, 7/8 in.	35697	\$120.00	
1-12771	Check Tube Screw, 7/8 in.	104431	\$7.20	
1-12806	Poppet Housing, 7/8 in.	105021	\$55.00	
1-11015	High-pressure Seat, 7/8 in.	35367	\$17.10	
1-12769	Low-pressure Poppet, 7/8 in. Fits all 55K pumps	104047	\$28.75	
1-11126	Poppet Spring, 7/8 in.	25648	\$3.55	
1-11245	Hydraulic Filter	27713	\$167.00	

Jet Edge



Pump parts

1 inch



Repair kits: Seals

AccuStream #	Description	Replaces	Price	
1-11451	Seal Repair Kit, 1 in. Includes seals, hoops, O-rings	—	\$143.00	
1-11673	Piston Seal Repair Kit, 1 in.	27602	\$67.00	

Repair kits: Check valves

AccuStream #	Description	Price	
1-11450	Check Valve Repair Kit, Old Style, 1 in. Includes low-pressure poppet, high-pressure poppet, poppet spring, seat	\$61.50	
1-12850	Check Valve Repair Kit, New Style, 1 in. Includes low-pressure poppet, high-pressure poppet, poppet spring, poppet seat housing	\$126.00	

















Replacement parts

AccuStream #	Description	Replaces	Price	
1-11253	Backup Disk Repair Kit, 1 in. Includes high-pressure seal assembly, backup housing, backup disk, rod seal, O-rings	102420	\$211.00	
1-11024	Seal, 1 in.	35574	\$20.50	
1-11018	Hoop, 1 in.	35572	\$17.10	
1-11251	Backup Disk, 1 in.	101914	\$40.25	
1-11247	Backup Ring, 1 in.	101913	\$128.00	
1-11090	Rod Seal, 1 in.	25953	\$10.90	
1-11091	O-ring Backup, 1 in.	26471	\$1.15	
1-11092	O-ring Backup, 1 in.	26472	\$1.15	
1-11023	Bearing, 1 in.	35567	\$343.00	
1-11047	High-pressure Cylinder, 1 in.	106882	\$775.00	
1-11199	Spacer Tube, 1 in.	35576	\$128.00	
1-11679-044	Cylinder O-ring, 1 in.	25947	\$1.55	

Pump parts

1 inch





Replacement parts

AccuStream #	Description	Replaces	Price	
1-11189	Hydraulic Cylinder, 1 in.	45005	\$333.00	
1-11674	Wear Ring, 4.5 in.	25001	\$6.00	
1-11673	Piston Seal	27602	\$67.00	
1-12852	Check Valve Assembly, 1 in. <i>Includes check tube, low-pressure poppet housing, low-pressure poppet, screw</i>	105027	\$635.00	
1-12770	Check Valve Adapter, 1 in.	35697	\$120.00	
1-12767	Check Tube, 1 in.	104874	\$585.00	
1-12771	Check Tube Screw, 1 in. <i>Fits all 55K pumps</i>	104431	\$7.20	
1-11014	High-pressure Poppet, 1 in. <i>Fits all 55K pumps</i>	35662	\$28.50	
1-11015	High-pressure Seat, 1 in. <i>Fits all 55K pumps</i>	35367	\$17.10	
1-12769	Low-pressure Poppet, 1 in. <i>Fits all 55K pumps</i>	104047	\$28.75	
1-12768	Low-pressure Poppet Housing, 1 in.	105023	\$55.00	
1-11126	Poppet Spring, 1 in.	25648	\$3.55	
1-11679-346	O-ring, -346	25003	\$1.55	
1-11680-346	O-ring Backup, 1 in.	25002	\$2.30	
1-11495	High-pressure End Cap, 1 in.	45691	\$715.00	
1-11235	Proximity Flag, 1 in.	35512	\$70.50	
1-11383	Nut, 1 in.	—	\$9.20	

Jet Edge

Pump parts

Filters

AccuStream #	Description	Replaces	Price	
1-11105	Water Filter Cartridge, 0.45 micron, 10 in.	25523	\$41.00	
1-11106	Water Filter Cartridge, 1.0 micron, 10 in.	25622	\$5.20	
1-11107	Water Filter Cartridge, 10.0 micron, 10 in.	25621	\$4.85	
1-11133	Hydraulic Filter 1-in. plunger	27797	\$142.00	

Replacement parts for KMT



KMT

Orifices

Autoline orifices

AccuStream #	Description	Price	
1-11280-XXX	Ruby Orifice	\$16.00	
1-11280D-XXX	Diamond Orifice	\$425.00	
1-21280-XXX	Ultra Sapphire Orifice	\$19.00	

Long-stem orifices

AccuStream #	Description	Price	
1-13587-XXX	Ruby Orifice	\$16.00	
1-12612D-XXX	Diamond Orifice	\$425.00	
1-23587-XXX	Ultra Sapphire Orifice	\$19.00	

-XXX indicates the availability of multiple sizes. Call us or visit AccuStream.com for details.

Focusing tubes

.375 ROC TEC® 100 focusing tubes

AccuStream #	Description	Replaces	Price	
1-12784-030-30	.375 Focusing Tube, .030 in. × 3.00 in.	10126969	\$75.00	
1-12784-040-30	.375 Focusing Tube, .040 in. × 3.00 in.	10126928	\$75.00	
1-12784-043-30	.375 Focusing Tube, .043 in. × 3.00 in.	—	\$75.00	
1-12784-063-30	.375 Focusing Tube, .063 in. × 3.00 in.	10126936	\$75.00	
1-12784-030-313	.375 Focusing Tube, .030 in. × 3.125 in.	10126969	\$75.00	
1-12784-040-313	.375 Focusing Tube, .040 in. × 3.125 in.	49835390	\$75.00	
1-12784-043-313	.375 Focusing Tube, .043 in. × 3.125 in.	10126928	\$75.00	
1-12784-043-25	.375 Focusing Tube, .043 in. × 2.50 in.	—	\$75.00	









.375 ROC TEC® 500 focusing tubes

AccuStream #	Description	Replaces	Price	
1-12895-030-313	.375 Focusing Tube, .030 in. × 3.125 in.	05097944	\$140.00	

Cutting heads



60K

Replacement parts

AccuStream #	Description	Replaces	Price	
1-13704	Complete Cutting Head, Water-only Includes 1-11436 Nozzle Tube	—	\$1,470.00	
1-13779	Complete Cutting Head, Water-only Includes 1-13708 Nozzle Tube	—	\$1,470.00	
1-11336	Autoline® Abrasive Wear Insert	05076955	\$176.00	
1-13708	Nozzle Tube, 3/8 in. × 7.65 in.	10138444	\$225.00	
1-11436	Nozzle Tube, 3/8 in. × 6 in.	10138428	\$214.00	
1-11430	Nozzle Tube, 3/8 in. × 3 in.	10181113	\$149.00	
1-11401	Nozzle Nut, 3/8 in. Use for water-only operation.	B2841	\$61.50	
1-14153	.281 Dialine Cutting Head Assembly Direct replacement for IDE® cutting head. Requires no additional configuration. Uses 1-12749-XXX diamond orifice.	—	\$510.00	

KMT**On/off valves****60K**

Repair kits

AccuStream #	Description	Replaces	Price	
1-12967	Complete On/off Valve Repair Kit Includes valve seat, valve seal, valve stem, brass backup ring, stainless steel backup ring	05116017 05116025	\$150.00	
1-11241	On/off Valve Repair Kit Does not include stainless steel backup ring	—	\$131.00	
1-13689	High-cycle On/off Valve Repair Kit Includes valve seat, valve seal, high-cycle stem, brass backup ring	—	\$261.00	



Replacement parts

AccuStream #	Description	Replaces	Price	
1-13242	Control Valve, Normally-closed	10138824	\$1,150.00	
1-13244	Control Valve, Normally-open	10184760	\$1,130.00	
1-12089	Actuator, Normally-closed	10177855	\$565.00	
1-13243	Actuator, Normally-open	10189553	\$474.00	
1-11320	Pneumatic Valve Body	10189181	\$396.00	
1-11102	Valve Stem	BV901184	\$71.50	
1-11099	Valve Seat	10178697	\$35.25	
1-11100	Valve Seal Assembly	10178978	\$22.70	
1-12733	Backup Ring Stainless steel	10187250	\$20.40	
1-11104	Backup Ring Valve	10188233	\$18.20	
1-11240	Valve O-ring	49895584	\$1.45	
1-12347	Valve Nut	BV701184	\$85.00	







On/off valves

100K

Repair kits





AccuStream #	Description	Replaces	Price	
1-14323	Pneumatic Valve Repair Kit, Normally-closed Includes seal assembly, needle stem, seal backup, valve seat, O-ring	20477521	\$165.00	
1-14324	Pneumatic Valve Repair Kit, Normally-open Includes seal assembly, needle stem, seal backup, valve seat, O-ring	20477518	\$165.00	

Replacement parts



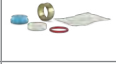

AccuStream #	Description	Replaces	Price	
1-14317	Valve Body	20475871	\$615.00	
1-14310	Valve Stem	20475878	\$108.00	
1-11099	Valve Seat	10178697	\$35.25	
1-14322	Seal Assembly	20474158	\$79.00	
1-14314	Backup Ring Bronze	20475874	\$27.25	
1-11240	Valve O-ring	49895584	\$1.45	

KMT**Pump parts****Streamline SL-IV and SL-V**

Repair kits: Seals

AccuStream #	Description	Replaces	Price	
1-12137	Dynamic Seal Assembly Repair Kit, SL-IV Includes dynamic seal backup, static seal	05123385	\$69.50	
1-12136	Static Seal Assembly Repair Kit, SL-IV Includes static seal backup, static seal	10110393	\$37.50	
1-12339	Dynamic Seal Assembly Repair Kit, SL-V Includes dynamic seal backup, static seal	05149703 20422243	\$70.50	
1-12411	Hydraulic Cartridge Seal Repair Kit Includes rod seals, backup rings, O-rings	80084759	\$41.00	
1-12597	Hydraulic Piston Repair Kit Includes check valve, snap rings, O-rings, piston ring, wear ring	05115951	\$179.00	



Repair kits: Sealing heads (check valves)

AccuStream #	Description	Replaces	Price	
1-11368	Sealing Head Repair Kit, SL-IV Includes inlet poppet, high-pressure poppet, high-pressure seat, inlet spring, poppet pin, O-ring	—	\$136.00	
1-14339	Sealing Head Repair Kit, SL-V, New Style Includes inlet poppet, high-pressure poppet, high-pressure seat, inlet spring, poppet pin, O-ring	20489495	\$165.00	
1-12713	Sealing Head Repair Kit, SL-V, Old Style Includes inlet poppet, high-pressure poppet, high-pressure seat, inlet spring, poppet pin, O-ring	80074057	\$136.00	
1-12389	Poppet Spare Parts Kit, SL-V Includes high-pressure poppet, high-pressure seat, poppet guide, compression spring	05133335	\$115.00	

Repair kits: Dump valves

AccuStream #	Description	Replaces	Price	
1-12593	Dump Valve Repair Kit Includes on/off valve repair kit, O-rings	05116017	\$136.00	







Assemblies

AccuStream #	Description	Replaces	Price	
1-14195	Intensifier Assembly, SL-V, New Style	—	\$14,100.00	
1-12568	Intensifier Assembly, SL-V, Old Style	80072333	\$14,100.00	

Pump parts



















Streamline SL-IV and SL-V

Replacement parts

AccuStream #	Description	Replaces	Price	
1-14196	Sealing Head Assembly, SL-V, New Style	20481005	\$1,130.00	
1-14173	Sealing Head Cylinder Liner, SL-V, New Style Use with 1-14196 New-style Sealing Head Assembly and 1-14167 New-style Sealing Head Body.	20497767 20481574	\$131.00	
1-14167	Sealing Head Body, SL-V, New Style	20481009	\$795.00	
1-14168	Inlet Poppet, SL-V, New Style	20453619	\$28.25	
1-14170	Inlet Poppet Retainer, SL-V, New Style	20474391	\$45.50	
1-14169	Inlet Poppet Screw, SL-V, New Style	20474395	\$28.25	
1-12596	Proximity Switch 20 volts to 250 volts AC/DC	05127584 20453934	\$428.00	
1-12567	Inlet Poppet Valve	05144662	\$21.90	
1-13802	Output Adapter Dump Valve	10079580	\$85.00	
1-12566	Poppet Retainer, SL-V, Old Style	05144670	\$54.50	
1-12388	Sealing Head Assembly, Old Style	80072349	\$1,130.00	
1-12565	High-pressure Cylinder Liner, SL-V, Old Style Use with 1-12107 Sealing Head Assembly, 1-12343 Sealing Head Body.	20418805	\$119.00	
1-12343	Sealing Head Body, SL-V, Old Style	49834039	\$820.00	
1-12341	Sealing Head Spacer, SL-V	05144696	\$27.25	
1-11314	Poppet Retainer, SL-IV	10118552	\$54.50	
1-11481	Sealing Head Assembly, SL-IV Use with 1-12107 Hydraulic Cartridge.	05116769	\$980.00	
1-11605	Cylinder Liner, SL-IV	05109624	\$131.00	
1-11317	Sealing Head Body, SL-IV	10106417	\$620.00	

Pump parts**Streamline SL-IV and SL-V**





Replacement parts

AccuStream #	Description	Replaces	Price	
1-11329	Inlet Compression Spring, SL-IV	49884562	\$5.70	
1-11316	Inlet Poppet, SL-IV	10107894	\$21.30	
1-11315	Poppet Pin, SL-IV	51167051	\$45.50	
1-11265	High-pressure Poppet, SL-IV	05116561	\$45.50	
1-11266	High-pressure Seat, SL-IV	05112768	\$30.75	
1-12346	Jackbolt, 7/16 in.	80070352	\$15.80	
1-12107	Hydraulic Cartridge Seal Assembly Use with 15-HP to 60-HP SL-IV and SL-V and 60-HP to 125-HP PRO2 units.	05130091	\$131.00	
1-13261	Hydraulic Cartridge Seal Assembly, E50 Use with 30-HP or 50-HP Classic units and 40-HP NEOLine units.	80086622	\$131.00	
1-11223	High-pressure Cylinder, SL-IV	05059712	\$1,130.00	
1-12342	High-pressure Cylinder Body, SL-V	05144647	\$1,560.00	
1-11604	High-pressure Cylinder Nut, SL-IV	05059688	\$600.00	
1-12344	High-pressure Cylinder Nut, SL-V	80073646	\$660.00	
1-11679-132	O-ring, -132, SL-V Use with 1-12344 High-pressure Cylinder Nut.	10074-920	\$1.55	
1-12551	Hydraulic Cylinder, SL-V	05034764	\$1,380.00	
1-12563	Hydraulic Cylinder Head, SL-IV / SL-V	05034772	\$770.00	
1-11680-240	Backup Ring, SL-V Use with 1-12563 Hydraulic Cylinder Head.	05034855	\$2.30	
1-11679-240	O-ring, -240, SL-V Use with 1-12563 Hydraulic Cylinder Head.	10075000	\$1.55	
1-11319	Sealing Head Gland	05116777	\$187.00	



Pump parts

Streamline SL-IV and SL-V

Replacement parts

AccuStream #	Description	Replaces	Price	
1-11330	Compression Spring	AV500260	\$3.60	
1-12564	Bushing Retainer Flange	05007786	\$133.00	
1-11606	Ceramic Plunger	05119151 80072333	\$1,760.00	
1-12562	Piston Assembly	05132253	\$900.00	
1-12578	Retaining Ring	05034798	\$12.00	

Filters

AccuStream #	Description	Replaces	Price	
1-14904	Water Filter Cartridge, 10 Micron, 20 in.	49834716	\$49.00	
1-14905	Water Filter Cartridge, 10 micron, 10 in.	10106722	\$82.00	
1-14906	Water Filter Cartridge, 30 Micron, 10 in.	10100782	\$5.10	

Pump parts**Streamline SL-V 75/100S**















Repair kits: Seals

AccuStream #	Description	Replaces	Price	
1-14271	Seal Assembly Repair Kit, SL-V 75/100S Includes dynamic seal backup, high-pressure seal	05149711	\$97.00	

Repair kits: Sealing heads (check valves)

AccuStream #	Description	Replaces	Price	
1-14338	Sealing Head Repair Kit, SL-V 75/100S Includes low-pressure poppet, high-pressure seat, discharge poppet valve, compression spring	80084403	\$193.00	

Replacement parts



AccuStream #	Description	Replaces	Price	
1-14259	Poppet Pin, SL-V 75/100S	05119839	\$47.75	
1-14260	Poppet Discharge Valve, SL-V 75/100S	05116603	\$70.50	
1-14262	Low-pressure Poppet, SL-V 75/100S	05119680	\$34.00	
1-14261	Poppet Retainer, SL-V 75/100S	05119698	\$119.00	
1-14268	Sealing Head Assembly, SL-V 75/100S	80072341	\$1,400.00	
1-14264	High-pressure Cylinder Body, SL-V 75/100S	20431076	\$1,830.00	
1-14253	High-pressure Cylinder Liner, SL-V 75/100S	05144555	\$176.00	
1-14270	Hydraulic Cartridge, SL-V 75/100S	05146584	\$176.00	
1-12578	Retaining Ring	05034798	\$12.00	
1-14255	Sealing Head Body, SL-V 75/100S	80071293	\$935.00	
1-14286	Sealing Head Nut, SL-V 75/100S	05116595	\$255.00	
1-14249	Sealing Head Spacer, SL-V 75/100S	05144597	\$27.25	
1-14263	Sealing Head Seat, SL-V 75/100S	05116579	\$66.00	
1-11330	Compression Spring	AV500260	\$3.60	
1-12346	Jackbolt, 7/16 in.	80070352	\$15.80	

Replacement parts for WSI







On/Off valves

Repair kits



AccuStream #	Description	Replaces	Price	
1-13118	Valve Repair Kit, VLV 1000 Includes valve stem, valve seat, valve seal assembly	VLV-1010	\$131.00	
1-13002	Valve Repair Kit, VLV 2000 Includes valve stem, valve seat, valve seal assembly	VLV-2010	\$131.00	

Replacement parts

AccuStream #	Description	Replaces	Price	
1-13001	Valve Body	VLV-1001	\$430.00	
1-13119	Valve Stem, VLV 1000	VLV-1003	\$74.00	
1-12999	Valve Stem, VLV 2000	VLV-BV-901184	\$74.00	
1-13000	Valve Seat	VLV-1004	\$39.75	
1-11100	Valve Seal Assembly	VLV-1005	\$22.70	

Pump parts







Repair kits: Seals

AccuStream #	Description	Price	
1-13638	High-pressure Seal Repair Kit Includes hoop, high-pressure seals, seal backup, backups	\$170.00	
1-11467	High-pressure Seal Repair Kit Includes hoops, high-pressure seals; does not include backups	\$107.00	

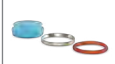
Repair kits: Check valves

AccuStream #	Description	Replaces	Price	
1-12854	Check Valve Repair Kit Includes spring, pin, ball, outlet ball seat, O-ring	WA1021	\$102.00	

Replacement parts

AccuStream #	Description	Replaces	Price	
1-12858	High-pressure Seal Assembly Includes hoop, high-pressure seal	WA1008	\$23.30	
1-12795	High-pressure Cylinder Body 50 hp to 100 hp	WA1006	\$1080.00	
1-12856	Check Valve Ball	WA1022	\$22.00	
1-11234	Check Valve Spring	WA1029	\$3.40	
1-12857	Outlet Ball Seat	WA1024	\$93.00	
1-11679-125	O-ring, -125	WA1023	\$1.55	

Replacement parts for high-pressure components



Replacement parts suitable for:

High-pressure components

Custom tubing

Hypertherm offers in-house coning, threading, bending and coiling of high-pressure tubing.

Custom tubing orders placed by 2:00 PM CST may be shipped the same day. Call to check availability.

AccuStream #	Tubing outer dimension (OD)	Cost per foot	Cost to cone and thread each end	Coiling available	Cost per bend
Custom	1/4 in.	\$22.50	\$16.00	yes	\$16.90
Custom	3/8 in.	\$28.75	\$16.00	no	\$16.90
Custom	9/16 in.	\$42.00	\$20.00	no	not available

Custom coils available in the following diameters: 2.500 • 6.00 • 7.500 • 8.750 • 9.500 • 10.000 • 10.750

Other custom coil diameters are available on request.

The diagrams below illustrate the measurements that are required to ensure a precise fit.

Diagram A shows a simple straight tube that is coned and threaded. Diagram B shows a custom tube with multiple bends.

Information required

- Outside diameter (OD)
- Length from tip to tip (A)

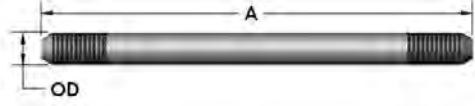

Diagram A

Information required

- Outside diameter (OD)
- Length from tip to outside edge (A)
- Length from outside edge to outside edge (B)
- Length from outside edge to tip (C)
- Radius (1 and 2)
- Minimum bend radius
 - 1/2 in. for 1/4-in. tubing
 - 1-1/2 in. for 3/8-in. tubing
- Minimum distance between bends
 - 3.50 in. for 1/4-in. tubing
 - 3.60 in. for 3/8-in. tubing

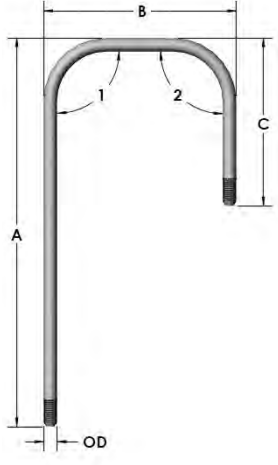

Diagram B

Provide all information to ensure an exact fit.

Shipping

- Tubing less than 8.5 feet long can be shipped by UPS or FedEx.
- 1/4-in. tubing more than 10 feet long can be coiled to ship by UPS or FedEx.
- 3/8-in. and 9/16-in. tubing that is more than 8.5 feet long must be shipped by LTL.

High-pressure tubing

60k tubing

1/4-inch outer diameter

AccuStream #	Description	Replaces	Price	
1-WJT46240AF	Tubing, 1/4 in. × 240 in. (20 ft)	A-0774-1 80074420	\$390.00	
1-WJT46288AF	Tubing, 1/4 in. × 288 in. (24 ft)	—	\$468.00	
1-WJT46360AF	Tubing, 1/4 in. × 360 in. (30 ft)	—	\$585.00	

Stock length, coned and threaded

3/8-inch outer diameter

AccuStream #	Description	Replaces	Price	
1-WJT66240AF	Tubing, 3/8 in. × 240 in. (20 ft)	A-0774-2 506478	\$476.00	

Stock length, coned and threaded

9/16-inch outer diameter

AccuStream #	Description	Replaces	Price	
1-WJT96240AF	Tubing, 9/16 in. × 240 in. (20 ft)	A-0774-3 5143474	\$705.00	

Stock length, coned and threaded

Replacement parts suitable for:

High-pressure components

High-pressure tubing

All AccuStream 60k tubing is autofrettaged to increase strength and durability.

100k tubing

AccuStream #	Description	Price	
1-WJT41108AF	Tubing, 1/4 in. × 108 in. (9 ft)	\$293.00	
1-WJT61108AF	Tubing, 3/8 in. × 108 in. (9 ft)	\$487.00	
1-WJT41264AF	Tubing, 1/4 in. × 264 in. (22 ft)	\$715.00	
1-WJT61264AF	Tubing, 3/8 in. × 264 in. (22 ft)	\$1,200.00	

Tubing is not coned or threaded.





Protective sheathing

AccuStream #	Description	Replaces	Price	
1-12579	Tubing Sheath, 1/4 in. Use with 60k or 100k 1/4-in. OD tubing.	A-2883	\$2.70	
1-12580	Tubing Sheath, 3/8 in. Use with 60k or 100k 3/8-in. OD tubing.	A-2884	\$3.75	



60K fittings

Swivel repair kits

Repair kits: 1/4 inch

AccuStream #	Description	Replaces	Price	
1-11360	Inline Minor Swivel Repair Kit, 1/4 in. Includes swivel seal, swivel hoop, swivel bearing	26183	\$48.00	
1-12864	90° Swivel Minor Repair Kit, 1/4 in. Use with 12863 90° Assembly. Includes swivel seal, swivel backup, terminal block, thrust bearing, swivel thrust washers, O-rings	—	\$103.00	
1-14592	90° Swivel Repair Kit, 1/4 in. Use with 13123 Dual-axis 90° Swivel Assembly. Includes seal assembly, backup swivel, thrust bearing shaft, thrust bearing washer, O-rings	B-5910-1	\$70.50	
1-13546	Parallel Swivel Repair Kit, 1/4 in. Use with 13338 Parallel Swivel Assembly. Includes backup ring, hoop, high-pressure seal, spacer	B-7447-1	\$93.00	

Repair kits: 3/8 inch





AccuStream #	Description	Replaces	Price	
1-12611	Inline and 90° Swivel Major Repair Kit, 3/8 in. Use with 12604 90° Assembly or 12605 Inline Assembly. Includes inline swivel seal, swivel bearing backup, thrust bearing, swivel shaft, metal-cased wiper, O-rings	—	\$262.00	
1-12610	Inline and 90° Swivel Minor Repair Kit, 3/8 in. Use with 12604 90° Assembly or 12605 Inline Assembly. Includes inline swivel seal, swivel bearing backup, thrust bearing, metal-cased wiper, O-rings	—	\$103.00	
1-11476	90° Swivel Repair Kit, 3/8 in. Includes seal, hoop, swivel bearing, thrust bearing, oil O-ring seal	007118-1	\$69.50	

High-pressure components

60K fittings

Swivels

Assemblies

AccuStream #	Description	Replaces	Price	
1-12607	Inline Swivel Assembly, 1/4-in. Female to male; use with 1-12609 Inline and 90° Swivel Major Repair Kit or 1-12608 Inline and 90° Swivel Minor Repair Kit. Includes swivel housings, bearing and bearing backup, swivel shaft, thrust bearing, swivel seal, antivibration assembly, O-rings	—	\$770.00	
1-12863	90° Swivel Assembly, 1/4-in. Female to female; use with 1-12864 90° Swivel Minor Repair Kit. Includes swivel seal, swivel backup, thrust bearing, O-ring	—	\$1,080.00	
1-13123	Dual-axis 90° Swivel Assembly, 1/4 in. Use with 1-14592 90° Swivel Repair Kit.	B-5725-1	\$1,360.00	
1-12605	Inline Swivel Assembly, 3/8-in. Female to male; use with 1-12611 Inline and 90° Swivel Major Repair Kit or 1-12610 Inline or 90° Swivel Minor Repair Kit. Includes swivel seal and housing, bearing backup, thrust bearing, swivel shaft, swivel bearing, bushing, O-rings	—	\$870.00	
1-12604	90° Swivel Assembly, 3/8-in. Female to male; use with 1-12611 Inline and 90° Swivel Major Repair Kit or 1-12610 Inline or 90° Swivel Minor Repair Kit. Includes swivel seal and housing, bearing backup, thrust bearing, swivel shaft, swivel bearing, bushing, O-rings	—	\$940.00	

60K fittings

Straight couplings

AccuStream #	Description	Replaces	Price	
1-13160-60-4	Straight Coupling, 1/4 in.	A-0780-1 A-0784-1 10079028 10078244	\$49.00	
1-13160-60-6	Straight Coupling, 3/8 in.	A-0780-2 A-0784-2 10078905 10079523	\$64.50	
1-13160-60-9	Straight Coupling, 9/16 in.	10078772 A-0780-3 10078640	\$96.00	

All AccuStream couplings include standard collars and glands.

Straight reducer couplings

AccuStream #	Description	Replaces	Price	
1-13160-60-4F6F	Straight Reducer Coupling, 1/4-in. Female to 3/8-in. Female	A-1461 10079614	\$64.50	
1-13160-60-4F9F	Straight Reducer Coupling, 1/4-in. Female to 9/16-in. Female	10078145	\$75.00	
1-13160-60-6F9F	Straight Reducer Coupling, 3/8-in. Female to 9/16-in. Female	A-2437 10079531	\$97.00	

All AccuStream couplings include standard collars and glands.

Collars

AccuStream #	Description	Replaces	Price	
1-13157-60-4	Collar, 1/4 in.	A-2867 10078426	\$4.60	
1-13157-60-6	Collar, 3/8 in.	A-2839 10078715	\$5.40	
1-13157-60-9	Collar, 9/16 in.	10079119	\$8.60	

Glands

AccuStream #	Description	Replaces	Price	
1-13158-60-4	Gland, 1/4 in.	A-2866 10078459	\$9.40	
1-13158-60-6	Gland, 3/8 in.	A-2838 10078129	\$11.50	
1-13158-60-9	Gland, 9/16 in.	10078608	\$14.60	

High-pressure components

60K fittings

Plugs

AccuStream #	Description	Replaces	Price	
1-13159-60-4	Plug, 1/4 in.	A-0784-1 10078244	\$8.90	
1-13159-60-6	Plug, 3/8 in.	A-0784-2 10079523	\$11.50	
1-13159-60-9	Plug, 9/16 in.	A-0784-3 10078772	\$14.00	

Adapters

AccuStream #	Description	Replaces	Price	
1-13162-60-4F6M	Adapter, 1/4-in. Female to 3/8-in. Male	A-0792-1 10079432	\$58.50	
1-13162-60-4F9M	Adapter, 1/4-in. Female to 9/16-in. Male	10079580	\$58.50	
1-13162-60-6F4M	Adapter, 3/8-in. Female to 1/4-in. Male	A-1267 10079473	\$55.50	
1-13162-60-6F9M	Adapter, 3/8-in. Female to 9/16-in. Male	A-4691 10079457	\$62.50	
1-13162-60-9F4M	Adapter, 9/16-in. Female to 1/4-in. Male	A-0792-3	\$67.00	
1-13162-60-9F6M	Adapter, 9/16-in. Female to 3/8-in. Male	10079424 10079655	\$67.00	

Crosses

AccuStream #	Description	Replaces	Price	
1-13165-60-4	Cross, 1/4 in.	A-0777-1 10097228	\$88.00	
1-13165-60-6	Cross, 3/8 in.	A-0777-2 10078038	\$105.00	
1-14372	Cross, 3/8 in No fittings	—	\$81.00	
1-13165-60-9	Cross, 9/16 in.	A-0777-3 10079168	\$166.00	

All AccuStream crosses include standard collars and glands.



Tees

AccuStream #	Description	Replaces	Price	
1-13163-60-4	Tee, 1/4 in.	A-0776-1 10079481	\$73.00	
1-13163-60-6	Tee, 3/8 in.	A-0776-2 10078590	\$81.00	
1-13535	Tee, 3/8 in No fittings	—	\$63.50	
1-13163-60-9	Tee, 9/16 in.	10079465	\$124.00	

All AccuStream tees include standard collars and glands.

60K fittings

Elbows

AccuStream #	Description	Replaces	Price	
1-13164-60-4	Elbow, 1/4 in.	A-0775-1 10079051	\$50.00	
1-13164-60-6	Elbow, 3/8 in.	A-0775-2 10078780	\$70.00	
1-13164-60-9	Elbow, 9/16 in.	A-0775-3 10078525	\$95.00	
1-13534	Elbow, 3/8 in. No fittings	—	\$48.25	

All AccuStream elbows include standard collars and glands.

Two-way straight valves

AccuStream #	Description	Replaces	Price	
1-13166-60-4	Two-way Straight Valve, 1/4 in.	A-0788-1 10079259	\$162.00	
1-13166-60-6	Two-way Straight Valve, 3/8 in.	A-0788-3 10078863	\$203.00	
1-13166-60-9	Two-way Straight Valve, 9/16 in.	A-0788-5 10078889	\$271.00	

Two-way angle valves

AccuStream #	Description	Replaces	Price	
1-13167-60-4	Two-way Angle Valve, 1/4 in.	A-0787-1 10079002	\$164.00	
1-13167-60-6	Two-way Angle Valve, 3/8 in.	A-0787-3 10078749	\$209.00	
1-13167-60-9	Two-way Angle Valve, 9/16 in.	A-0787-5 10079275	\$250.00	

Three-way angle valves

AccuStream #	Description	Price	
1-13252-60-6	Three-way Angle Valve, 3/8 in.	\$281.00	
1-13252-60-9	Three-way Angle Valve, 9/16 in.	\$306.00	

Inline wyes

AccuStream #	Description	Price	
1-13614-6-4-4	Inline Wye, 3/8 in. to 1/4 in.	\$323.00	
1-13614-6-6-6	Inline Wye, 3/8 in. to 3/8 in.	\$375.00	

All AccuStream elbows include standard collars and glands.

High-pressure components

60K fittings



Antivibration assemblies

AccuStream #	Description	Price	
1-13495	Antivibration Assembly, 1/4 in.	\$35.75	
1-14266	Antivibration Assembly, 3/8 in.	\$35.75	

Antivibration assemblies are compatible with standard high-pressure products. Individual antivibration components are for use with AccuStream antivibration assemblies.

100K fittings

Swivels

AccuStream #	Description	Replaces	Price	
1-14493	90° Swivel Repair Kit, 1/4 in. Use with 1-14444 90° Swivel Assembly. Includes swivel seal rings, seal backup rings, swivel shafts, needle thrust bearings, antivibration assemblies, O-rings	015093-1	\$810.00	
1-14444	90° Swivel Assembly, 1/4 in. Use with 1-14493 90° Swivel Repair Kit. Includes swivel seal housing, swivel seals, seal hoops, swivel bearings, swivel bearing housings, swivel guides, bushings, needle thrust bearings, antivibration assemblies, O-rings	014922-1	\$2,080.00	

Antivibration assemblies are compatible with standard high-pressure products. Individual antivibration components are for use with AccuStream antivibration assemblies.

Antivibration assemblies

AccuStream #	Description	Price	
1-14369	Antivibration Assembly, 1/4 in.	\$73.00	

Collars

AccuStream #	Description	Replaces	Price	
1-13157-100-4	100k Collar, 1/4 in.	044348-1	\$12.90	
1-13157-100-6	100k Collar, 3/8 in.	015115-1	\$16.70	

Glands

AccuStream #	Description	Replaces	Price	
1-13158-100-4	100k Gland, 1/4 in.		\$23.00	
1-13158-100-6	100k Gland, 3/8 in.	A-2838	\$25.00	

Plugs

AccuStream #	Description	Replaces	Price	
1-13159-60-4	100k Plug, 1/4 in.	A-0784-1 10078244	\$8.90	
1-13159-60-6	100k Plug, 3/8 in.	A-0784-2 10079523	\$11.50	

100K fittings

Crosses

AccuStream #	Description	Replaces	Price	
1-13165-100-6	100k Cross, 3/8 in.	014168-1	\$313.00	

Tees

AccuStream #	Description	Replaces	Price	
1-13163-100-4	100k Tee, 1/4 in.	A-21776-1	\$214.00	
1-13163-100-6	100k Tee, 3/8 in.		\$235.00	

Elbows

AccuStream #	Description	Price	
1-13164-100-4	100k Elbow, 1/4 in.	\$177.00	
1-13164-100-6	100k Elbow, 3/8 in.	\$195.00	

Replacement parts suitable for:

High-pressure components

Nipples

1/4 inch

AccuStream #	Description	Replaces	Price
1-WJN4600275	Nipple, 1/4 in. x 2.75 in.	—	\$14.60
1-WJN4600600	Nipple, 1/4 in. x 6 in.	13168-60-4-6 A-0781-6 10103018	\$22.90
1-WJN4600800	Nipple, 1/4 in. x 8 in.	13168-60-4-8 A-0781-8	\$25.00
1-WJN4601000	Nipple, 1/4 in. x 10 in.	13168-60-4-10 10057636 80070519	\$27.25
1-WJN4609600	Nipple, 1/4 in. x 96 in. (8 ft)	204658-96	\$164.00

Lengths longer than 3.00 in. are available on request.

3/8 inch

AccuStream #	Description	Price
1-WJN6600300	Nipple, 3/8 in. x 3 in.	\$22.90
1-WJN6600400	Nipple, 3/8 in. x 4 in.	\$27.25
1-WJN6600600	Nipple, 3/8 in. x 6 in.	\$32.25
1-WJN6600800	Nipple, 3/8 in. x 8 in.	\$37.50
1-WJN6601000	Nipple, 3/8 in. x 10 in.	\$40.75
1-WJN6601200	Nipple, 3/8 in. x 12 in.	\$50.00
1-WJN6601400	Nipple, 3/8 in. x 14 in.	\$57.50
1-WJN6601700	Nipple, 3/8 in. x 17 in.	\$62.50
1-WJN6601800	Nipple, 3/8 in. x 18 in.	\$63.50
1-WJN6602450	Nipple, 3/8 in. x 24-1/2 in.	\$73.00
1-WJN6602600	Nipple, 3/8 in. x 26 in.	\$77.00
1-WJN6603100	Nipple, 3/8 in. x 31 in.	\$88.00
1-WJN6603600	Nipple, 3/8 in. x 36 in. (3 ft)	\$98.00
1-WJN6604300	Nipple, 3/8 in. x 43 in.	\$107.00
1-WJN6604800	Nipple, 3/8 in. x 48 in. (4 ft)	\$127.00
1-WJN6605000	Nipple, 3/8 in. x 50 in.	\$132.00
1-WJN6605500	Nipple, 3/8 in. x 55 in.	\$143.00
1-WJN6606500	Nipple, 3/8 in. x 65 in.	\$165.00
1-WJN6608900	Nipple, 3/8 in. x 89 in.	\$220.00
1-WJN6614200	Nipple, 3/8 in. x 142 in.	\$340.00
1-WJN6614300	Nipple, 3/8 in. x 143 in.	\$342.00
1-WJN6616800	Nipple, 3/8 in. x 168 in. (14 ft)	\$399.00

Lengths longer than 3.50 in. are available on request.





9/16 inch

AccuStream #	Description	Price
1-WJN9600400	Nipple, 9/16 in. x 4.00 in.	\$36.50
1-WJN9600800	Nipple, 9/16 in. x 8.00 in.	\$52.50





Lengths longer than 3.50 in. are available on request.

Hardware

Tube clamp pairs

AccuStream #	Description	Price	
1-12838	Tube Clamp Pair, 1/4 in.	\$2.85	
1-13144	Tube Clamp Pair, 3/8 in.	\$3.30	
1-13143	Tube Clamp Pair, 9/16 in.	\$3.45	
1-12837	Top Plate, 1/4 in. and 3/8 in.	\$1.75	
1-12830	Top Plate, 9/16 in.	\$1.75	

Inline filters







AccuStream #	Description	Replaces	Price	
1-13852	Inline Filter Assembly, 1/4-in. Female to female	—	\$510.00	
1-13853	Inline Filter Element, 1/4-in. Use with 1-13852 Inline Filter Assembly.	—	\$39.75	
1-11598	Inline Filter Assembly, 3/8-in. Female to male	—	\$232.00	
1-11600	Inline Filter Element, 3/8-in. Use with 1-11598 Inline Filter Assembly.	—	\$43.25	
1-13285	Inline Filter Assembly, 9/16-in. Female to female	—	\$3,325.00	

High-pressure components

Tools

Coning and threading tools

Tool sets





AccuStream #	Description	Replaces	Price	
1-13269	Tube Bender Assembly Use with 60k and 100k tubing.	—	\$880.00	
1-15492	Complete Coning and Threading Tool Set Includes 1/4-in., 3/8-in. and 9/16-in. tools	14536-60-CCT	\$1,750.00	
1-15440	Coning and Threading Tool Set Includes 1/4-in. and 3/8-in. tools	14536-60-4-6	\$1,130.00	
1-15493	Coning and Threading Tool Set Includes 1/4-in. tools	14536-60-4	\$890.00	
1-15494	Coning and Threading Tool Set Includes 3/8-in. tools	14536-60-6	\$890.00	
1-15495	Coning and Threading Tool Set Includes 9/16-in. tools	14536-60-9	\$890.00	
1-12798	Coning and Threading Oil, SULFLO #1	—	\$27.50	

All sets include a threading die, a collet, a cutter, a guide bushing, and coning and threading oil. Sets do not include tube bender assembly.





Tools

Coning and threading tools





1/4 inch

AccuStream #	Description	Replaces	Price	
1-15439	Threading Die, 1/4 in., Left-hand	1/4-28LH	\$76.00	
1-15513	Guide Bushing, 1/4 in.	13154-60-4	\$47.00	
1-15496	Coning Tool Collet, 1/4 in.	13155-60-4	\$97.00	
1-15499	Coning Tool Cutter, 1/4 in.	13156-60-4	\$128.00	

3/8 inch

AccuStream #	Description	Replaces	Price	
1-15477	Threading Die, 3/8 in., Left-hand	3/8-24LH	\$76.00	
1-15514	Guide Bushing, 3/8 in.	13154-60-6	\$47.00	
1-15497	Coning Tool Collet, 3/8 in.	13155-60-6	\$97.00	
1-15500	Coning Tool Cutter, 3/8 in.	13156-60-6	\$128.00	

9/16 inch









AccuStream #	Description	Replaces	Price	
1-15478	Threading Die, 9/16 in., Left-hand	9/16-18LH	\$76.00	
1-15515	Guide Bushing, 9/16 in.	13154-60-9	\$47.00	
1-15498	Coning Tool Collet, 9/16 in.	13155-60-9	\$97.00	
1-15501	Coning Tool Cutter, 9/16 in.	13156-60-9	\$128.00	

Replacement parts suitable for:

High-pressure components







Tools

Other tools

AccuStream #	Description	Replaces	Price	
1-12387	Seal Installation Tool Kit Use with Flow® pumps. Includes seal insertion push tool, seal insertion locator tool, seal insertion tool sleeve guide, seal installation washer	B-2291-1	\$273.00	
1-12029	Bleed-down Tool Use with Flow® pumps.	—	\$136.00	
1-13705	Cylinder Wrench Use with Flow® pumps.	A-6333	\$655.00	
1-13725	End-cap Spanner Wrench Use with Flow® pumps.	A-1628	\$109.00	
1-13972	Water Filter Wrench	—	\$6.90	
1-11210-XX	Lapping Paper Available in 12-, 15- and 30-micron sheets	—	\$4.25	
1-13281	Granite Surface Plate 9 in. × 12 in. × 2 in.	—	\$92.00	
1-13897	TDS Meter	—	\$57.00	

-XX indicates the availability of multiple sizes. Call us or visit AccuStream.com for details.

Lubricants

AccuStream #	Description	Replaces	Price	
1-11448	Accu Goop Food-grade antiseize lubricant, 4 oz.	A-2185 10087385	\$26.50	
1-11111	Blue Goop Oil-based thread lubricant, 2 oz.	A-2185 302692 20460486	\$30.50	
1-13537	Pure Goop Halocarbon-based thread lubricant, 1 oz.	10084440	\$52.00	
1-11447	High-vacuum Grease Seal O-ring lubricant, 5 oz.	200006	\$1.70	
1-11136	High-vacuum Grease 5.3 oz.	A-4689	\$58.50	
1-14511	Extreme-pressure Antiscoring Lubricant 0.25 oz.	202496	\$3.30	
1-13969	O-ring Lubricant 4 oz.	—	\$35.50	

Gauges

AccuStream #	Description	Price	
1-12028	Gauge, Back-mount	\$910.00	
1-12106	Gauge, Bottom-mount	\$935.00	

A team to keep you up and running

Like you, we know that uptime is money. That's why we've put together an exceptional support team and all the information tools you need to stay ahead of unexpected problems and delays. It's all part of our commitment to service.

- Voicemail-free, expert waterjet support during business hours
- Global distribution ensures fast response and speedy parts delivery
- Hypertherm Associates Waterjet Mobile Assistant application for iOS and Android
- Online technical guides with step-by-step repair instructions (<http://assist.hypertherm.com>)
- Available on-site product training

We ship faster so you're back to work sooner

Our goal as owners is to ensure that you get what you need when you need it.

Place your order by 2:30 PM CST and we will ship it the same day.

From our job shop roots, we know how it feels to be down, so we will do everything we can to keep you cutting.



Waterjet Mobile Assistant gives you instant access to detailed, step-by-step maintenance and repair procedures, including part numbers.

Get the mobile app

Download the Hypertherm Associates Waterjet Mobile Assistant app from the App Store for iOS or from Google Play for Android using the links below.



SHAPING POSSIBILITY®

PLASMA | LASER | WATERJET | AUTOMATION | SOFTWARE | CONSUMABLES

sales@accustream.com | www.accustream.com | (866) 566-7099

Hypertherm, DiaLine, and AccuStream are trademarks of Hypertherm, Inc. and may be registered in the United States and/or other countries. All other trademarks are the properties of their respective owners.

Please visit www.hypertherm.com/patents for more details about Hypertherm Associates patent numbers and types.

© 12/2023 Hypertherm, Inc. Revision 8
897010

As 100% Associate owners, we are all focused on delivering a superior customer experience. www.hyperthermassociates.com/ownership

Environmental stewardship is one of Hypertherm Associates' core values. www.hyperthermassociates.com/environment



100% Associate-owned

