

DESIGN N°

5365

ADVANCED



SIRDAR

WEST YORKSHIRE
Est_1880

WEST YORKSHIRE
BRITISH
DESIGN,
EXPERTISE AND
CRAFTSMANSHIP
TRUSTED BY
GENERATIONS
OF HAND
KNITTERS
EST_1880



WE TRIPLE-CHECK
OUR PATTERNS TO
GUARANTEE SUCCESS
WHEN YOU USE
SIRDAR YARNS

SNUGGLY

3 PLY

0-12 MONTHS
& PREMATURE

MORE COLOURS
ON BACK PAGE



SIRDAR

WEST YORKSHIRE
Est_1880

SNUGGLY

3 PLY

Established in West Yorkshire in 1880, Sirdar is a British yarn company with a rich hand knitting heritage. Generations of families have grown up wearing Sirdar hand knitting yarns and designs.

Sirdar Snuggly is the brand our customers trust to keep their little ones warm and comfortable. Every Sirdar Snuggly yarn has been rigorously tested so you know it will be kind to your baby's tender skin and remain soft and gentle, wash after wash.

Snuggly 3-ply is a fine weight yarn in a small range of classic pastels designed especially for babies. Pretty and practical, stays soft and comfortable through machine washing and can be tumble dried.



"I love the sweet stitch details which make Snuggly 3 Ply patterns feel extra special."

TRY THESE SHADES

Turn to the back page to choose your favourite.



303 Cream



321 Pastel Blue

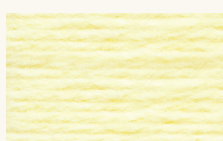

320 Pastel Lemon









302 Pearly Pink

**The yarn for this pattern may be available in the existing ball band or a new ball band as shown here.*

MEASUREMENTS

Follow the pattern instructions for your size

Age	Prem	Newborn	0-3 months	3-6 months	6-9 months	9-12 months
Chest 	29 cm 11½"	36 cm 14"	42 cm 16½"	46 cm 18"	50 cm 19¾"	52 cm 20½"
Width 	33 cm 13"	40 cm 15¾"	46 cm 18"	50 cm 19¾"	54 cm 21¼"	56 cm 22"
Full Length 	19 cm 7½"	22 cm 8¾"	25 cm 9¾"	27 cm 10¾"	28 cm 11"	32 cm 12½"
Sleeve Length 	9 cm 3½"	12 cm 4¾"	16 cm 6¼"	17 cm 6½"	18 cm 7"	20 cm 8"
Yarn * No Balls 	1	1	2	2	2	2
Buttons 	4	4	4	5	5	5
Yarn	F073 Snuggly 3 Ply, 50g, shade 303					
Button Ref	Sirdar Elegant Button Code B5670-0094					
You also need	1 Pair of 3¼mm (UK10 – USA3) Knitting Needles and 1 Pair of 2¾mm (UK12 – USA2) Knitting Needles.					

*Average number of balls required when you use the specified Sirdar yarn and tension shown below

TENSION & NEEDLES

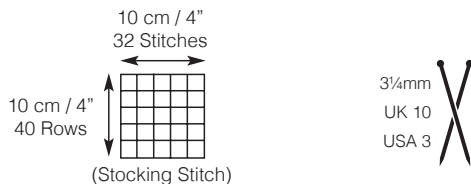

PIECE MEASUREMENTS

- A 7 [8:11:11:12:12]cm
(2¾ [3:4¼:4¼:4¾:4¾]")
- B 8 [8:9:10:11:12]cm
(3 [3:3½:4:4¼:4¾]")
- C 4 [4:5:5:6:6]cm
(1½ [1½:2:2:2½:2½]")
- D 19 [22:25:27:28:32]cm
(7½ [8¾:9¾:10¾:11:12½]")
(measured from back of neck)
- E 16.5 [20:23:25:27:28]cm
(6½ [8:9:9¾:10¾:11]")
- F 12 [14:15:15:15:16]cm
(4¾ [5½:6:6:6:6¼]")
- G 15 [17:19:20:21:22]cm
(6 [6½:7½:8:8¾:8¾]")
- H 9 [12:16:17:18:20]cm
(3½ [4¾:6¼:6½:7:8]")

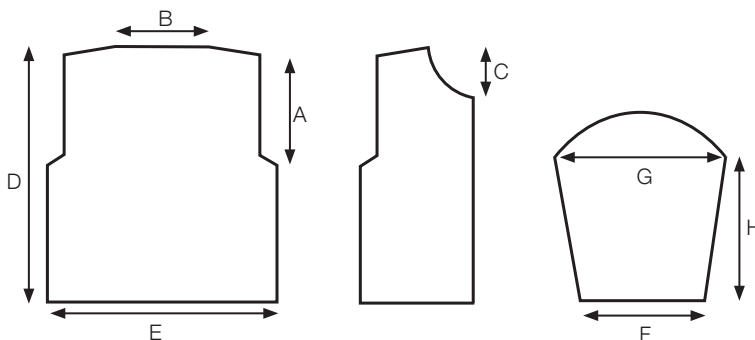

STITCHES & ABBREVIATIONS

beg - beginning
cm - centimetres
cont - continue
dec - decrease(ing)
folll - following
g - grammes
in - inch(es)
inc - increase(ing)
k - knit
mm - millimetres
p - purl
rem - remain(ing)
rs - right side
st(s) - stitch(es)
tog - together
ws - wrong side
yfwd - yarn forward
0 - no stitches or rows

BACK

Using 2¾mm needles and thumb method cast on **52** [**64:74:80:86:90**] sts.

1st Row. Knit.

This row will now be referred to as **g-st** (garter stitch).

Work 9 rows more in g-st.

Change to 3¼mm needles and proceed as follows:-

1st Row. Knit.

2nd Row. Purl.

1st and 2nd rows will now be referred to as **st-st** (stocking stitch).**

Working in st-st (throughout) cont until back measures **11** [**13:13:15:17:19**]cm, (**4¼** [**5¼:5¼:6:6½:7½**]in), ending with a ws row.

SHAPE ARMHOLES

Work **3** [**4:4:5:5:5**] rows dec 1 st at each end of every row.
46 [**56:66:70:76:80**] sts.

Cont without shaping until armholes measure **7** [**8:11:11:12:12**]cm, (**2¾** [**3:4¼:4¼:4¾:4¾**]in), ending with a ws row.

SHAPE SHOULDERS

Cast off **5** [**7:9:9:10:10**] sts at beg of next 2 rows. **36** [**42:48:52:56:60**] sts.
Cast off **5** [**8:10:10:10:11**] sts at beg of next 2 rows. **26** [**26:28:32:36:38**] sts.
Cast off rem **26** [**26:28:32:36:38**] sts.

LEFT FRONT

Using 2¾mm needles and thumb method cast on **24** [**30:35:38:41:43**] sts.

Work 10 rows in g-st.

Change to 3¼mm needles and working in st-st (throughout) cont until left front measures **11** [**13:13:15:17:19**]cm, (**4¼** [**5¼:5¼:6:6½:7½**]in), ending with a ws row.

SHAPE ARMHOLE

Next Row. K2tog (armhole edge), knit to end. **23** [**29:34:37:40:42**] sts.

Next Row. Purl to last 2 sts, p2tog. **22** [**28:33:36:39:41**] sts.

Work **1** [**2:2:3:3:3**] rows dec 1 st at armhole edge in every row.

21 [**26:31:33:36:38**] sts.

Cont without shaping until armhole measures **4** [**5:7:7:7:7**]cm, (**1½** [**2:2¾:2¾:2¾:2¾**]in), ending with a rs row.

SHAPE NECK

Next Row. Cast off **5** [**5:5:6:7:8**] sts (neck edge), purl to end.

16 [**21:26:27:29:30**] sts.

Next Row. Knit to last 2 sts, k2tog. **15** [**20:25:26:28:29**] sts.

Work **5** [**5:3:5:5:5**] rows dec 1 st at neck edge in every row.

10 [**15:22:21:23:24**] sts.

Work **0** [**0:5:3:5:5**] rows dec 1 st at neck edge in **0** [**0:1st:1st:1st:1st**] and every foll **0** [**0:2nd:2nd:2nd:2nd**] row. **10** [**15:19:19:20:21**] sts.

Cont without shaping until armhole measures **7** [**8:11:11:12:12**]cm, (**2¾** [**3:4¼:4¼:4¾:4¾**]in), ending with a ws row.

SHAPE SHOULDER

Next Row. Cast off **5** [**7:9:9:10:10**] sts, knit to end. **5** [**8:10:10:10:11**] sts.

Next Row. Purl.

Cast off rem **5** [**8:10:10:10:11**] sts.

RIGHT FRONT

Using 2¾mm needles and thumb method cast on **24** [**30:35:38:41:43**] sts.

Work 10 rows in g-st.

Change to 3¼mm needles and working in st-st (throughout) cont until right front measures **11** [**13:13:**

15:17:19]cm, (**4¼** [**5¼:5¼:6:6½:7½**]in), ending with a ws row.

SHAPE ARMHOLE

Next Row. Knit to last 2 sts, k2tog (armhole edge). **23** [**29:34:37:40:42**] sts.

Next Row. P2tog, purl to end.

22 [**28:33:36:39:41**] sts.

Work **1** [**2:2:3:3:3**] rows dec 1 st at armhole edge in every row.

21 [**26:31:33:36:38**] sts.

Cont without shaping until armhole measures **4** [**5:7:7:7:7**]cm, (**1½** [**2:2¾:2¾:2¾:2¾**]in), ending with a ws row.

SHAPE NECK

Next Row. Cast off **5** [**5:5:6:7:8**] sts (neck edge), knit to end.

16 [**21:26:27:29:30**] sts.

Next Row. Purl.

Next Row. K2tog, knit to end.

15 [**20:25:26:28:29**] sts.

Work **5** [**5:3:5:5:5**] rows dec 1 st at neck edge in every row.

10 [**15:22:21:23:24**] sts.

Work **0** [**0:5:3:5:5**] rows dec 1 st at neck edge in **0** [**0:1st:1st:1st:1st**] and every foll **0** [**0:2nd:2nd:2nd:2nd**] row.

10 [**15:19:19:20:21**] sts.

Cont without shaping until armhole measures **7** [**8:11:11:12:12**]cm, (**2¾** [**3:4¼:4¼:4¾:4¾**]in), ending with a rs row.

SHAPE SHOULDER

Next Row. Cast off **5** [**7:9:9:10:10**] sts, purl to end. **5** [**8:10:10:10:11**] sts.

Next Row. Knit.

Cast off rem **5** [**8:10:10:10:11**] sts.

SLEEVES (Both alike)

Using 2¾mm needles and thumb method cast on **38** [**44:48:48:48:52**] sts.

Work 10 rows in g-st.

Change to 3¼mm needles.

Working in st-st (throughout) inc 1 st at each end of 5th and every foll **2nd** [**6th:8th:6th:4th:6th**] row to **42** [**54:60:62:60:66**] sts.

For **1st, 4th, 5th and 6th sizes only**

Inc 1 st at each end of every foll **4th** [**8th:6th:8th**] row to **48** [**64:68:70**] sts.

For all 6 sizes

Cont without shaping until sleeve measures 9 [12:16:17:18:20]cm, (3½ [4¾:6¼:6½:7:8]in), ending with a ws row.

SHAPE SLEEVE TOP

Work 3 [4:4:5:5:5] rows dec 1 st at each end of every row.

42 [46:52:54:58:60] sts.

Work 1 [0:0:1:1:1] rows without shaping.

Cast off 4 [2:3:2:3:3] sts at beg of next 8 [2:8:2:12:10] rows.

10 [42:28:50:22:30] sts.

Cast off 0 [3:4:3:4:4] sts at beg of next 0 [10:4:12:2:4] rows.

10 [12:12:14:14:14] sts.

Cast off rem 10 [12:12:14:14:14] sts.

NECKBAND

Join shoulder seams. With rs facing, using 2¾mm needles pick up and knit 20 [20:23:24:29:30] sts evenly along right side of neck, 24 [24:26:30:34:36] sts evenly from 26 [26:28:32:36:38] cast off sts at back of neck, 20 [20:23:24:29:30] sts evenly along left side of neck.

64 [64:72:78:92:96] sts.

Work 4 rows in g-st.

Cast off knitways.

LEFT FRONT BORDER

With rs facing, using 2¾mm needles pick up and knit 4 sts evenly along neckband, 36 [45:50:57:64:70] sts evenly along front edge and 6 sts evenly along g-st.

46 [55:60:67:74:80] sts.

FOR A GIRL

Work 6 rows in g-st.

Cast off knitways.

FOR A BOY

Work 3 rows in g-st.

4th Row (Buttonhole row). K3 [3:2:2:2:3], yfwd, k2tog, (k11 [14:16:13:15:16], yfwd, k2tog) 3 [3:3:4:4:4] times, k2 [2:2:3:2:3].

Work 2 rows more in g-st.

Cast off knitways.

RIGHT FRONT BORDER

With rs facing, using 2¾mm needles pick up and knit 6 sts evenly along g-st, 36 [45:50:57:64:70] sts evenly along front edge and 4 sts evenly along neckband. 46 [55:60:67:74:80] sts.

FOR A BOY

Work 6 rows in g-st.

Cast off knitways.

For a Girl

Work 3 rows in g-st.

4th Row (Buttonhole row). K2 [2:2:3:2:3], yfwd, k2tog, (k11 [14:16:13:15:16], yfwd, k2tog) 3 [3:3:4:4:4] times, k3 [3:2:2:2:3].

Work 2 rows more in g-st.

Cast off knitways.

TO MAKE UP

Fold sleeves in half lengthways then placing folds to shoulder seams, sew sleeves in position. Join side and sleeve seams. Sew on buttons. Pin out garment to the measurement given. Cover with damp cloths and leave until dry. See ball band for washing and further care instructions.





DESIGN N° 3029



DESIGN N° 3028



DESIGN N° 3983

SIRDAR
WEST YORKSHIRE
EST. 1880
SNUGGLY
 3 PLY

 CHOOSE YOUR NEXT
 PROJECT



DESIGN N° 5364



DESIGN N° 5366



DESIGN N° 3982



DESIGN N° 1665



DESIGN N° 3266

SNUGGLY

3 PLY

CHOOSE YOUR FAVOURITE COLOUR

303 Cream



321 Pastel Blue



320 Pastel Lemon



302 Pearly Pink



SIRDAR

WEST YORKSHIRE
Est. 1880

