

DESIGN N°

5450

INTERMEDIATE



# SIRDAR

WEST YORKSHIRE  
Est\_1880



WE TRIPLE-CHECK  
OUR PATTERNS TO  
GUARANTEE SUCCESS  
WHEN YOU USE  
SIRDAR YARNS

## SNUGGLY

DOUBLE KNITTING

0-2 YEARS

MORE COLOURS  
ON BACK PAGE



# SIRDAR

WEST YORKSHIRE  
Est\_1880

# SNUGGLY

Established in West Yorkshire in 1880, Sirdar is a British yarn company with a rich hand knitting heritage. Generations of families have grown up wearing Sirdar hand knitting yarns and designs.

Sirdar Snuggly is the brand our customers trust to keep their little ones warm and comfortable. Every Sirdar Snuggly yarn has been rigorously tested so you know it will be kind to your baby's tender skin and remain soft and gentle, wash after wash.

Our *Walk In The Woods* collection combines Britain's favourite baby yarn, Snuggly DK and Snuggly 4 Ply, with soft, fluffy Snuggly Bunny to create irresistible little outfits with a woodland theme, many with cute woodland friend motifs for baby to discover.



*“These knits really have the aah factor which makes them perfect for photos to share with friends and family.”*

## TRY THESE SHADES

Turn to the back page to choose your favourite.



514 Squirrel



326 Denim Blue

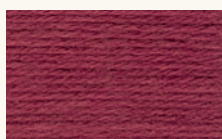



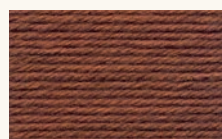



484 Cherry Pie



513 Tawny

MEASUREMENTS

Follow the pattern instructions for your size

Age		0-3 months	3-6 months	6-9 months	9-12 months	12-18 months	18-24 months
Chest		42 cm 16½"	46 cm 18"	50 cm 19¾"	52 cm 20½"	54 cm 21¼"	56 cm 22"
Width		46 cm 18"	50 cm 19¾"	54 cm 21¼"	57 cm 22½"	59 cm 23¼"	61 cm 24"
Full Length		25 cm 9¾"	27 cm 10¾"	30 cm 11¾"	32 cm 12½"	34 cm 13½"	36 cm 14"
Sleeve Length		16 cm 6¼"	17 cm 6½"	18 cm 7"	20 cm 8"	22 cm 8¾"	25 cm 9¾"
<b>Sweater</b>							
Yarn* No Balls		2	2	3	3	3	3
<b>Waistcoat</b>							
Yarn* No Balls		2	2	2	2	2	2
Yarn	F075 Snuggly, DK, 50g, Sweater shade 514 Squirrel, Waistcoat shade 510 Rosebud						
You also need	I Pair of 4mm (UK8 – USA6) Knitting Needles and I Pair of 3¼mm (UK10 – USA3) Knitting Needles. Stitch Holders for Sweater. 3¼mm (UK10 – USA3) Double Pointed Needles or Circular Needle for Waistcoat						

\*Average number of balls required when you use the specified Sirdar yarn and tension shown below.

TENSION & NEEDLES

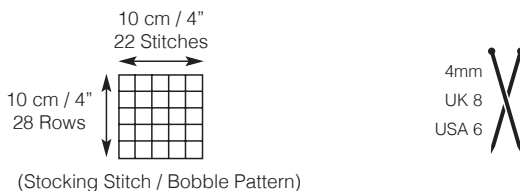

PIECE MEASUREMENTS

- A 23 [25:27:28.5:29.5:30.5] cm (9 [9¾:10¾:11¼:11¾:12]")
- B 25 [27:30:32:34:36] cm (9¾ [10¾:11¾:12½:13½:14]") (measured from back neck)
- C 11 [11:12:12:13:14] cm (4¼ [4¼:4¾:4¾:5¼:5½]")
- D 10 [11:12:13:13:13] cm (4 [4¼:4¾:5¼:5¼:5¼]")
- E 19 [20:21:22:23:24] cm (7½ [8:8¼:8¾:9:9½]")
- F 5 [5:6:6:6] cm (2 [2:2½:2½:2½:2½]")
- G 15 [15:15:16:16:17] cm (6 [6:6:6¼:6¼:6½]")
- H 16 [17:18:20:22:25] cm (6¼ [6½:7:8:8¾:9¾]")
- I 19 [20:21:22:23:24] cm (7½ [8:8¼:8¾:9:9½]")
- J 7 [7:8:8.5:9:10] cm (2¾ [2¾:3:3¼:3½:4]")
- K 13 [13:14:14:15:16] cm (5¼ [5¼:5½:5½:6:6¼]")
- L 11.5 [12.5:13.5:14:14.5:15] cm (4½ [5:5¼:5½:5¾:6]")
- M 10 [10:11:11:12:12] cm (4 [4:4¼:4¼:4¾:4¾]")

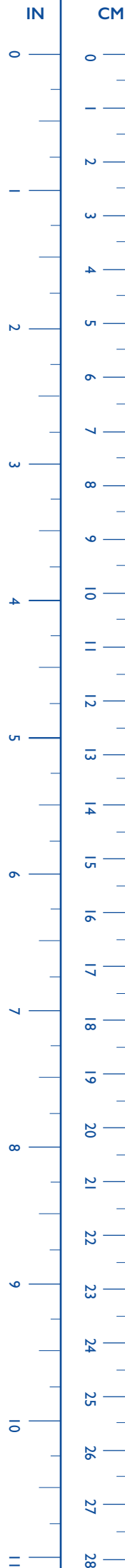
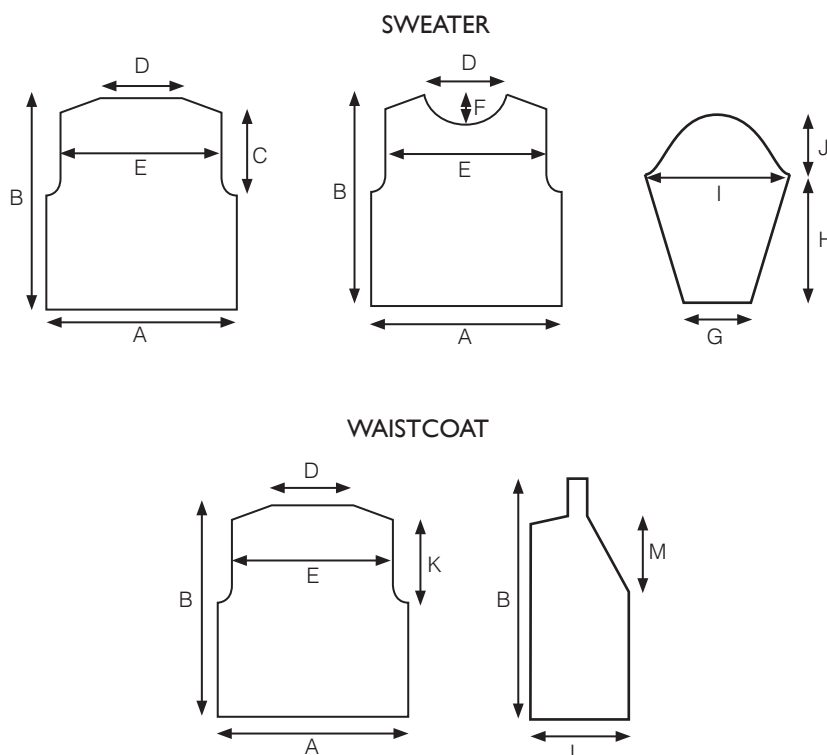

## STITCHES & ABBREVIATIONS

alt - alternate  
beg - beginning  
cm - centimetres  
cont - continue  
dec - decrease(ing)  
DK - double knitting  
foll - following  
g - grammes  
in - inch(es)  
inc - increase(ing)  
k - knit  
mm - millimetres  
0 - no stitches or times  
p - purl  
patt - pattern  
psso - pass slipped stitch over  
rem - remain(ing)  
rep - repeat  
rs - right side  
sl - slip 1 stitch knitways  
st(s) - stitch(es)  
tog - together  
ws - wrong side  
ml - pick up loop between last and next stitch and knit into the back of this loop  
MB - make bobble:- knit into front, back, front and back of next st, turn, p4, turn, k4, turn, (p2tog) twice, turn, k2tog, bobble completed.

## SWEATER BACK

Using 3¼mm needles and thumb method cast on 61 [65:71:75:77:79] sts.  
**1st Row.** \* K1, p1, rep from \* to last st, k1.  
**2nd Row.** P1, \* k1, p1, rep from \* to end.  
1st and 2nd rows set 1x1 rib.  
Work 5 rows more in 1x1 rib.  
**8th Row.** P2 [4:1:3:4:5], p2tog, (p4, p2tog) 9 [9:11:11:11:11] times, p3 [5:2:4:5:6]. 51 [55:59:63:65:67] sts. \*\*  
Change to 4mm needles and proceed as follows:-  
**1st Row.** Knit.  
**2nd Row.** Purl.  
1st and 2nd rows set st-st (stocking stitch). \*\*\*  
Working in st-st (throughout) cont until back measures 13 [15:17:19:20:21]cm, (5¼ [6:6½:7½:8:8¼]in), ending with a ws row.

## SHAPE ARMHOLES

Cast off 3 sts at beg of next 2 rows. 45 [49:53:57:59:61] sts.  
Work 2 [2:3:2:2:2] rows dec 1 st at each end of every row. 41 [45:47:53:55:57] sts.

### For 4th, 5th and 6th sizes only

Work 3 rows dec 1 st at each end of next and foll alt row. [49:51:53] sts.

### For all 6 sizes

Cont without shaping until armholes measure 7.5 [7.5:8:8:9:10]cm, (2¾ [2¾:3:3:3½:4]in), ending with a ws row.  
Work 10 [10:12:12:12:12] rows more.

## SHAPE SHOULDERS

Cast off 4 [5:5:5:5:6] sts at beg of next 2 rows. 33 [35:37:39:41:41] sts.  
Cast off 5 [5:5:5:6:6] sts at beg of next 2 rows. 23 [25:27:29:29:29] sts.  
Leave rem 23 [25:27:29:29:29] sts on a stitch holder.

## FRONT

Work as given for Back to \*\*.  
Change to 4mm needles and proceed as follows:-  
**1st Row.** Knit.  
**2nd Row.** Purl.  
**3rd and 4th Rows.** As 1st and 2nd rows.  
**5th Row.** K1 [3:5:7:8:1], \* MB, k7, rep from \* to last 2 [4:6:8:9:2] sts, MB, k1 [3:5:7:8:1].  
**6th Row.** Purl.  
**7th to 10th Row.** Rep 1st and 2nd rows twice.  
**11th Row.** K5 [7:1:3:4:5], \* MB, k7, rep from \* to last 6 [8:2:4:5:6] sts, MB, k5 [7:1:3:4:5].  
**12th Row.** Purl.  
From 1st to 12th row sets bobble patt. Keeping continuity of bobble patt (throughout) cont until front measures 13 [15:17:19:20:21]cm, (5¼ [6:6½:7½:8:8¼]in), ending with a ws row.

## SHAPE ARMHOLES

Cast off 3 sts at beg of next 2 rows. 45 [49:53:57:59:61] sts.  
Work 2 [2:3:2:2:2] rows dec 1 st at each end of every row. 41 [45:47:53:55:57] sts.

### For 4th, 5th and 6th sizes only

Work 3 rows dec 1 st at each end of next and foll alt row. [49:51:53] sts.

### For all 6 sizes

Cont without shaping until armholes measure 7.5 [7.5:8:8:9:10]cm, (2¾ [2¾:3:3:3½:4]in), ending with a ws row.

## SHAPE NECK

**Next Row.** Patt 13 [14:15:15:16:17], turn, leave rem 28 [31:32:34:35:36] sts on a stitch holder.  
Working on these 13 [14:15:15:16:17] sts only proceed as follows:-  
**Next Row.** Purl.  
Work 2 rows dec 1 st at neck edge in every row. 11 [12:13:13:14:15] sts.  
Work 3 [3:5:5:5:5] rows dec 1 st at neck edge in next and every foll alt row. 9 [10:10:10:11:12] sts.  
Work 3 rows more without shaping.

## SHAPE SHOULDER

**Next Row.** Cast off 4 [5:5:5:5:6] sts, patt to end. 5 [5:5:5:6:6] sts.  
**Next Row.** Purl.  
Cast off rem 5 [5:5:5:6:6] sts.

With rs facing, working on rem 28 [31:32:34:35:36] sts, slip 15 [17:17:19:19:19] sts onto a stitch holder, rejoin yarn to rem 13 [14:15:15:16:17] sts and patt to end.

### Next Row.

Purl.  
Work 2 rows dec 1 st at neck edge in every row. 11 [12:13:13:14:15] sts.  
Work 3 [3:5:5:5:5] rows dec 1 st at neck edge in next and every foll alt row. 9 [10:10:10:11:12] sts.  
Work 4 rows more without shaping.

## SHAPE SHOULDER

**Next Row.** Cast off 4 [5:5:5:5:6] sts, purl to end. 5 [5:5:5:6:6] sts.  
**Next Row.** Patt.  
Cast off rem 5 [5:5:5:6:6] sts.

## SLEEVES (Both alike)

Using 3¼mm needles and thumb method cast on 39 [39:39:41:41:43] sts, work 5 rows in 1x1 rib.  
**6th Row.** P3 [3:3:4:4:3], p2tog, (p4 [4:4:4:4:5], p2tog) 5 times, p4 [4:4:5:5:3]. 33 [33:33:35:35:37] sts.  
Change to 4mm needles and proceed as follows:-  
**1st Row.** Knit.  
**2nd Row.** Purl.  
**3rd and 4th Rows.** As 1st and 2nd rows.  
**5th Row.** Inc in 1st st, k3 [3:3:4:4:5], \* MB, k7, rep from \* to last 5 [5:5:6:6:7] sts, MB, k2 [2:2:3:3:4], inc in next st, k1. 35 [35:35:37:37:39] sts.  
**6th Row.** As 2nd row.  
**7th and 8th Rows.** As 1st and 2nd rows.  
**9th Row.** (Inc in 1st st) 0 [1:1:1:1:0] times, knit to last 0 [2:2:2:2:0] sts, (inc in next st, k1) 0 [1:1:1:1:0] times. 35 [37:37:39:39:39] sts.  
**10th Row.** Purl.  
**11th Row.** (Inc in 1st st) 0 [0:0:0:0:1] times, k1 [2:2:3:3:2], \* MB, k7, rep from \* to last 2 [3:3:4:4:4] sts, MB, k1 [2:2:3:3:1], (inc in next st, k1) 0 [0:0:0:0:1] times. 35 [37:37:39:39:41] sts.

### 12th Row.

Purl.  
From 1st to 12th row sets position of bobble patt.  
Keeping continuity of bobble patt (throughout) inc 1 st at each end of 1st [3rd:1st:3rd:3rd:5th] and every foll 8th [6th:4th:6th:6th:6th] row to 39 [45:43:49:51:47] sts.

### For 1st, 3rd and 6th sizes only

Inc 1 st at each end of every foll 10th [6th:8th] row to 41 [47:53] sts.

### For all 6 sizes

Cont without shaping until sleeve measures 16 [17:18:20:22:25]cm, (6¼ [6½:7:8:8¼:9¾]in), ending with a ws row.

## SHAPE SLEEVE TOP

Cast off 3 sts at beg of next 2 rows. 35 [39:41:43:45:47] sts.



Work 2 [4:4:4:4] rows dec 1 st at each end of every row. 31 [31:33:35:37:39] sts.  
Work 12 [8:10:12:14:16] rows dec 1 st at each end of next and every foll alt row. 19 [23:23:23:23:23] sts.  
Work 2 [4:4:4:4] rows dec 1 st at each end of every row. 15 sts.  
Cast off 4 sts at beg of next 2 rows. 7 sts.  
Cast off rem 7 sts.

## NECKBAND

Join right shoulder seam. With rs facing, using 3¼mm needles pick up and knit 12 [12:14:14:14:14] sts evenly along left side of neck, knit across 15 [17:17:19:19:19] sts left on a stitch holder at front of neck as follows:- k3 [4:4:3:3:3], m1, (k3, m1) 3 [3:3:4:4:4] times, k3 [4:4:4:4:4], pick up and knit 12 [12:14:14:14:14] sts evenly along right side of neck and knit across 23 [25:27:29:29:29] sts left on a stitch holder at back of neck as follows:- k1 [2:3:2:2:2], m1 (k5, m1) 4 [4:4:5:5:5] times, k2 [3:4:2:2:2].  
71 [75:81:87:87:87] sts.  
Starting with 2nd row of 1x1 rib work 5 rows. Cast off loosely in rib.

## TO MAKE UP

Join left shoulder and neckband seams. Fold sleeves in half lengthways then placing folds to shoulder seams, sew sleeves in position. Join side and sleeve seams. Pin out garment to the measurement given. Cover with damp cloths and leave until dry. See ball band for washing and further care instructions.

## WAISTCOAT BACK

Work as given for Back of Sweater to \*\*\*.

Working in st-st (throughout) cont until back measures 11 [13:15:17:18:19]cm, (4¼ [5¼:6:6½:7:7½]in), ending with a ws row.

## SHAPE ARMHOLES

Cast off 3 sts at beg of next 2 rows. 45 [49:53:57:59:61] sts.

Work 2 [2:3:2:2:2] rows dec 1 st at each end of every row. 41 [45:47:53:55:57] sts.

### For 4th, 5th and 6th sizes only

Work 3 rows dec 1 st at each end of next and foll alt row. [49:51:53] sts.

### For all 6 sizes

Cont without shaping until armholes measure 13 [13:14:14:15:16]cm, (5¼ [5¼:5½:5½:6:6¼]in), ending with a ws row.

## SHAPE SHOULDERS

Cast off 4 [5:5:5:5:6] sts at beg of next 2 rows. 33 [35:37:39:41:41] sts.

Cast off 5 [5:5:5:6:6] sts at beg of next 2 rows. 23 [25:27:29:29:29] sts.

Cast off rem 23 [25:27:29:29:29] sts.

## LEFT FRONT

Using 3¼mm needles and thumb method cast on 31 [33:35:37:39:41] sts.

Work 7 rows in 1x1 rib.

8th Row. Rib 7, p2 [3:4:3:3:1], p2tog, (p4 [4:4:5:4:4], p2tog) 3 [3:3:3:4:5] times, p2 [3:4:4:3:1]. 27 [29:31:33:34:35] sts.

Change to 4mm needles and proceed as follows:-

1st Row. Knit to last 6 sts, (p1, k1) 3 times.

2nd Row. (P1, k1) 3 times, purl to end.

3rd and 4th Rows. As 1st and 2nd rows.

5th Row. K2 [3:4:4:1:2], \* MB, k7, rep from \* to last 9 [10:11:13:9:9] sts, MB, k2 [3:4:6:2:2], (p1, k1) 3 times.

6th Row. (P1, k1) 3 times, purl to end.

7th to 10th Row. Rep 1st and 2nd rows twice.

11th Row. K6 [7:8:8:5:6], \* MB, k7, rep from \* to last 13 [14:15:9:13:13] sts, MB, k6 [7:8:2:6:6], (p1, k1) 3 times.

12th Row. (P1, k1) 3 times, purl to end.

From 1st to 12th row sets position of bobble patt and 1x1 rib front edging.

Keeping continuity of bobble patt and 1x1 rib (throughout) cont until left front measures 11 [13:15:17:18:19]cm, (4¼ [5¼:6:6½:7:7½]in), ending with a ws row.

## SHAPE ARMHOLE

Next Row. Cast off 3 sts, patt to end. 24 [26:28:30:31:32] sts.

Next Row. Patt.

Work 2 [2:3:2:2:2] rows dec 1 st at armhole edge in every row.

22 [24:25:28:29:30] sts.

### For 4th, 5th and 6th sizes only

Work 3 rows dec 1 st at armhole edge in next and foll alt row. [26:27:28] sts.

### For all 6 sizes

Work 6 [8:7:5:5:5] rows without shaping.

## SHAPE NECK

1st Row. Patt to last 9 sts, k2tog, k1, (p1, k1) 3 times. 21 [23:24:25:26:27] sts.

1st row sets neck shaping.

Next Row. Patt.

### For 2nd, 3rd, 4th, 5th and 6th sizes only

Work [4:4:8:6:4] rows dec 1 st at neck edge as before in next and every foll alt row. [21:22:21:23:25] sts.

### For all 6 sizes

Work 17 [13:17:13:17:21] rows dec 1 st at neck edge as before in next and every foll 4th row. 16 [17:17:17:18:19] sts.

Cont without shaping until armhole measures 13 [13:14:14:15:16]cm, (5¼ [5¼:5½:5½:6:6¼]in), ending with a ws row.

## SHAPE SHOULDER

Next Row. Cast off 4 [5:5:5:5:6] sts, patt to end. 12 [12:12:12:13:13] sts.

Next Row. Patt.

Cast off 5 [5:5:5:6:6] sts, patt to end. 7 sts.

## BACK NECK EDGING.

Next Row. Rib to end, cast on 1 st (cast on st to be used to sew edging to back of neck). 8 sts.

Next Row. (P1, k1) 4 times.

This row sets rib.

Cont until edging is of sufficient length to reach centre back of neck.

Cast off in rib.

## RIGHT FRONT

Using 3¼mm needles and thumb method cast on 31 [33:35:37:39:41] sts.

Work 7 rows in 1x1 rib.

8th Row. P2 [3:4:4:3:1], p2tog, (p4 [4:4:5:4:4], p2tog) 3 [3:3:3:4:5] times, p2 [3:4:3:3:1], rib 7. 27 [29:31:33:34:35] sts.

Change to 4mm needles and proceed as follows:-

1st Row. (K1, p1) 3 times, knit to end.

2nd Row. Purl to last 6 sts, (k1, p1) 3 times.

3rd and 4th Rows. As 1st and 2nd rows.

5th Row. (K1, p1) 3 times, k2 [3:4:6:2:2], \* MB, k7, rep from \* to last 3 [4:5:5:2:3] sts, MB, k2 [3:4:4:1:2].

6th Row. Purl to last 6 sts, (k1, p1) 3 times.

7th to 10th Row. Rep 1st and 2nd rows twice.

11th Row. (K1, p1) 3 times, k6 [7:8:2:6:6], \* MB, k7, rep from \* to last 7 [8:9:9:6:7] sts, MB, k6 [7:8:8:5:6].

12th Row. Purl to last 6 sts, (k1, p1) 3 times.

From 1st to 12th row sets position of 1x1 rib front edging and bobble patt.

Keeping continuity of 1x1 rib and bobble patt (throughout) cont until right front measures 11 [13:15:17:18:19]cm,

(4¼ [5¼:6:6½:7:7½]in), ending with a rs row.

## SHAPE ARMHOLE

Next Row. Cast off 3 sts, patt to end. 24 [26:28:30:31:32] sts.

Work 2 [2:3:2:2:2] rows dec 1 st at armhole edge in every row.

22 [24:25:28:29:30] sts.

### For 4th, 5th and 6th sizes only

Work 3 rows dec 1 st at armhole edge in next and foll alt row. [26:27:28] sts.

### For all 6 sizes

Work 6 [8:7:5:5:5] rows without shaping.

## SHAPE NECK

1st Row. (K1, p1) 3 times, k1, s1, k1, pss0, patt to end. 21 [23:24:25:26:27] sts.

1st row sets neck shaping.

Next Row. Patt.

### For 2nd, 3rd, 4th, 5th and 6th sizes only

Work [4:4:8:6:4] rows dec 1 st at neck edge as before in next and every foll alt row. [21:22:21:23:25] sts.

### For all 6 sizes

Work 17 [13:17:13:17:21] rows dec 1 st at neck edge as before in next and every foll 4th row. 16 [17:17:17:18:19] sts.

Cont without shaping until armhole measures 13 [13:14:14:15:16]cm, (5¼ [5¼:5½:5½:6¼]in), ending with a rs row.

### SHAPE SHOULDER

**Next Row.** Cast off 4 [5:5:5:5:6] sts, patt to end. 12 [12:12:12:13:13] sts.

**Next Row.** Patt.

Cast off 5 [5:5:5:6:6] sts, patt to end. 7 sts.

### BACK NECK EDGING.

**Next Row.** Rib to end, cast on 1 st (cast on st to be used to sew edging to back of neck). 8 sts.

**Next Row.** (P1, k1) 4 times.

This row sets rib.

Cont until edging is of sufficient length to reach centre back of neck.

Cast off in rib.

### ARMHOLE EDGINGS

#### (Both alike)

Join shoulder seams. With rs facing, using 3¼mm needles pick up and knit 67 [67:71:71:77:81] sts evenly all round armhole.

Starting with 2nd row of 1x1 rib work 5 rows.

Cast off in rib.

### I-CORD TIES (Both alike)

Using 3¼mm double pointed needles or 3¼mm circular needle cast on 3 sts.

**1st Row.** Knit to end, do not turn. Slide sts to other end of needle and bring yarn across back of the work from the last st worked ready to work the next row from the rs again.

Rep 1st row until i-cord measures 17cm, (6½in).

Cast off.

### TO MAKE UP

Join side and armhole edging seams.

Join seam at centre back of neck. Sew

back neck edging to back neck. Sew

on i-cord ties at start of neck shaping.

Pin out garment to the measurement given. Cover with damp cloths and leave until dry. See ball band for washing and further care instructions.



DESIGN N° 5428



ALL THESE DESIGNS AND MORE IN BOOK 564

  
**SIRDAR**  
WEST YORKSHIRE  
EST. 1980

# SNUGGLY

DOUBLE KNITTING,  
4 PLY & BUNNY

CHOOSE BABY'S  
NEXT WALK IN THE  
WOODS PROJECT



DESIGN N° 5430



DESIGN N° 5431



DESIGN N° 5449



# SNUGGLY

DOUBLE KNITTING

CHOOSE YOUR FAVOURITE COLOUR

514 Squirrel



326 Denim Blue



484 Cherry Pie



513 Tawny



## SIRDAR

WEST YORKSHIRE  
Est. 1880

FOR MORE INSPIRATION

[f/knitsirdar](https://www.facebook.com/knitsirdar) #SIRDARMAKES [@knitsirdar](https://www.instagram.com/knitsirdar) [p/knitsirdar](https://www.pinterest.com/knitsirdar)

[www.sirdar.com](http://www.sirdar.com)

Printed in UK  
SPAS5450



5 054714 054502 >