



WOLF TOOTH®

S.H.I.S. HEADSET IDENTIFICATION

1 Identify Headset Type

EXTERNAL CUP (EC)

Bearing sits in cup outside of head tube



ZERO STACK (ZS)

Bearing sits in cup inside of head tube

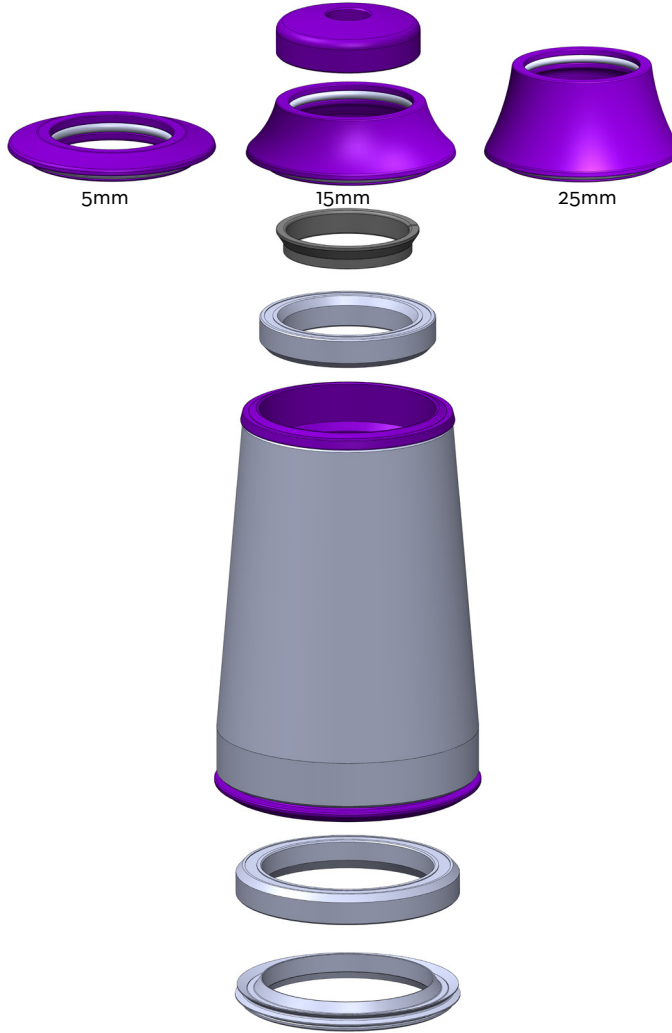

INTEGRATED (IS)

Bearing sits directly in head tube



2 Measure Headtube

INSIDE DIAMETER (ID)
Rounded to nearest mm

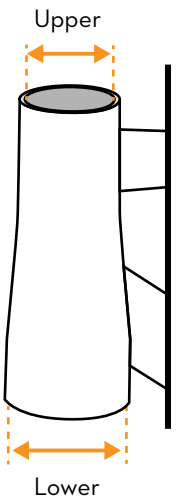

3 Measure Steerer Tube

OUTSIDE DIAMETER (OD)
Rounded to nearest 0.1 mm

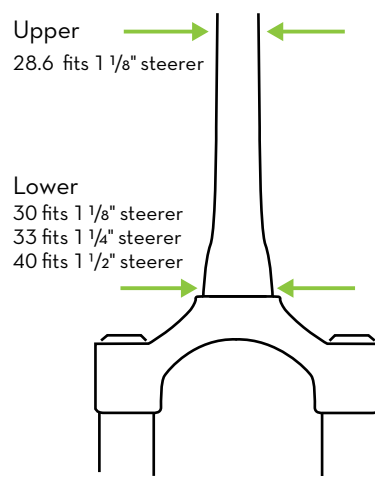

4 Find Your Headset

UPPER

EC
Headset Type

34
Headtube ID

28.6
Steerer tube OD

LOWER

EC
Headset Type

44
Headtube ID

40
Steerer tube OD

WOLF TOOTH® PRECISION HEADSETS

- Choose headset type (EC, ZS, IS)
- Pick 1 upper and 1 lower
- Available in 3 different stack heights
- Mix and match from a variety of colors

EC34 | 28.6

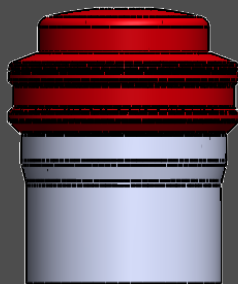

EC (EXTERNAL CUP)
Bearing sits in cup outside of frame

ZS44 | 28.6

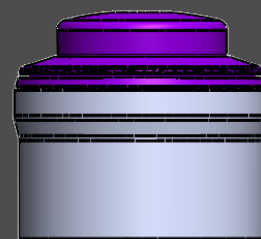

ZS (ZEROSTACK)
Bearing sits in cup inside of frame

IS41 | 28.6

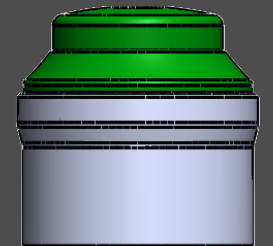

IS (INTEGRATED)
Bearing sits directly in frame

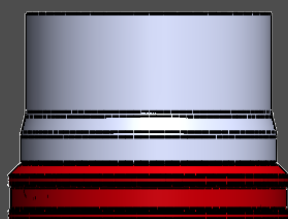

EC34 | 30

EC44 | 40

EC49 | 40

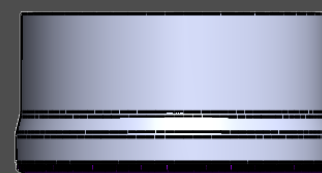

ZS56 | 40

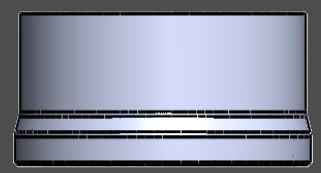

IS52 | 40

Follow us on:



Explore more product solutions at:

wolfteethcomponents.com