

Service Manual



Wolf Tooth Resolve® Dropper Service Instructions

[HOUSING CLEAN AND RE-GREASE](#)

[ADDING TRAVEL ADJUST SPACERS](#)

[CARTRIDGE REBUILD](#)

PRE-RIDE CHECK

Ensure proper operation of the post with the following steps:

1. Check that stanchion tube is clean and free of any mud or debris. Clean stanchion with a damp towel if necessary.
2. Check operation of remote lever. If present, remove any slack in cable using the remote lever's barrel adjuster. Lever should actuate and return smoothly. If lever feel is rough, check for any excessive wear or damage to the lever. Replace cable, housing and/or remote lever if necessary.
3. Check operation of dropper. Post should feel smooth through down and up-strokes. Ensure that seatpost collar on frame is not overtightened - this will cause binding in the seatpost. If post is still not operating smoothly, a re-grease of the housing pins or a cartridge service may be necessary.
4. If necessary, check air pressure
 - a. Always wear safety glasses when checking or adjusting air pressure
 - b. Saddle must be removed from post, air cap and valve are located at top end of the post
 - c. Always check air pressure with the post in fully-extended (top-out) position
 - d. Pressure too low will result in slow or non-extension of the post
 - e. Pressure too high will make the post difficult to drop
 - f. Do not exceed 260 PSI (18 bar) maximum pressure
5. Check saddle cradle bolts - torque to 6 Nm



HOUSING CLEAN AND RE-GREASE

Tools required:

- 4mm hex key
- Hollow XZN16 Socket (included with purchase of post)
- Parallel-jaw pliers-wrench such as Knipex 86 03 250 (must have jaw capacity greater than 27mm)
 - If not available, an adjustable wrench or 27mm open-end wrench can be used, but the Knipex tool is preferable as it will not mar the faces of the lower cradle
- 3/8" drive torque wrench
- Lightweight suspension grease such as Buzzy's Slick Honey, Slickoleum, or RSP Slick Kick
- 7mm open-end wrench
- 13mm cone wrench
- Pick (straight or bent tip)
- Isopropyl Alcohol (90% or greater ideal)
- Low-lint or lint-free towels
- Internal snap-ring pliers, tip diameter 1-2mm
- Safety glasses

Procedure:

1. Always start with post fully extended. Use 4mm hex key to remove saddle bolts and cradle hardware.



2. Remove air cap, but do not release pressure from cartridge.



3. Use hollow XZN16 socket (included in dropper post packaging) to remove lockring. Hold lower cradle with parallel-jaw pliers wrench such as Knipex 86 03 250 (ideal), adjustable wrench, or 27mm open-end wrench.

NOTE: A parallel-jaw pliers-wrench such as the Knipex 86 03 250 or 86 03 300 is the best tool to use to hold the lower cradle when installing or removing lockring. While an adjustable wrench or a 27mm open-end wrench will work, they will leave marks on the ends of the wrench flats of the lower cradle. These marks will not affect function of the post.



4. Pull up firmly to remove lower cradle from stanchion. If the low cradle sticks to the stanchion, tap upward with plastic faced hammer.



5. Slide stanchion down to expose piston rod end cap. Remove upper o-ring and set aside.



6. Use 7mm open-end wrench to hold piston rod. Remove rod-end cap using 13mm cone wrench.

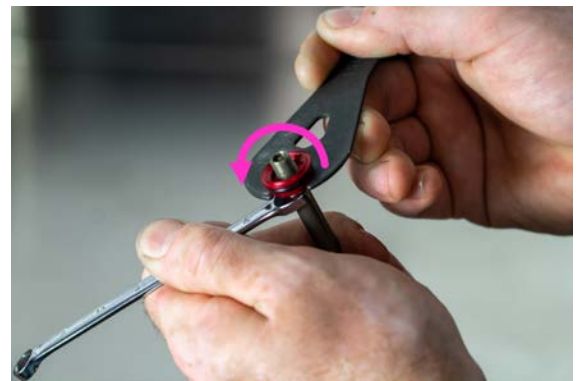

7. Use internal snap-ring pliers to remove snap-ring from bottom of post.

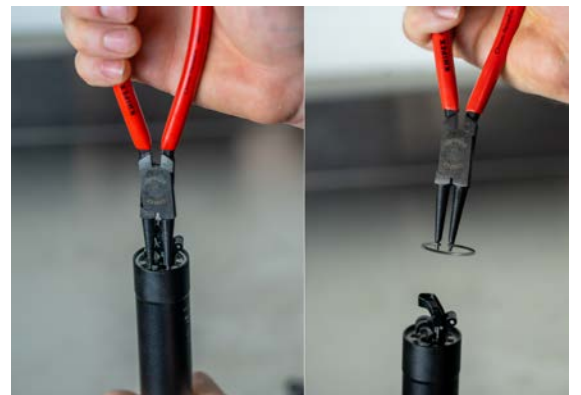

8. Use a pick to unseat and remove plastic air filter retainer ring.



9. Reinstall air cap on end of piston rod. Push end of piston rod against workbench firmly to unseat the cartridge. Remove the air cap and slide the cartridge out of the housing.

Set cartridge aside.



10. Slide stanchion out of bottom of lower tube. Be careful not to lose the brass anti-rotational pins as they are removed with the stanchion.



11. Remove brass pins from stanchion. Wipe clean and set aside. If replacement pins are needed - take note of diameter of each pin. Replacement pins are available in 4 diameters, ranging from 1.96mm to 2.02mm. Pin diameter may be determined by presence of cut rings on the side of the pin (see illustration).

NOTE: the diameter of the pins will determine the amount of rotational play in the saddle when installed. Larger diameter pins will reduce the play but also make the post more prone to binding.

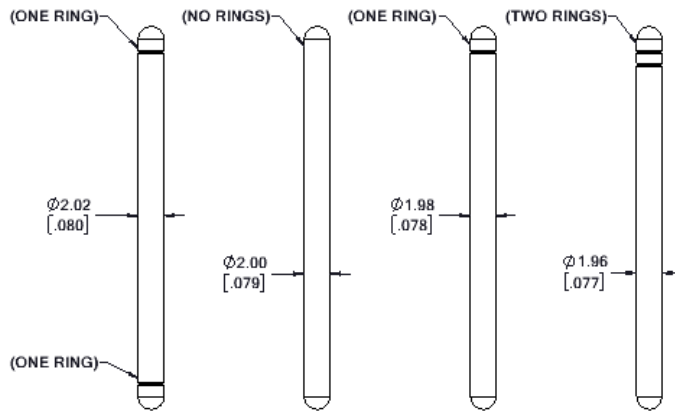

12. Remove wiper seal. Clean and inspect for any damage to seal lip. Replace wiper seal if any damage is found. Replacement of wiper seal is recommended every 100 hours or as needed



13. Clean stanchion and lower tube using isopropyl alcohol and a clean low-lint or lint-free towel. Pay particular attention to pin channels on inside of lower tube and pin grooves on stanchion.



14. Remove split bushing from bottom of stanchion.
Wipe bushing clean.



15. Install wiper seal into top of lower tube. Apply a light coat of grease to inside of wiper seal. We recommend a new wiper seal every year or 100 hours of use.



16. Apply a generous (a least 1 teaspoon) amount of grease evenly distributed inside the lower tube.

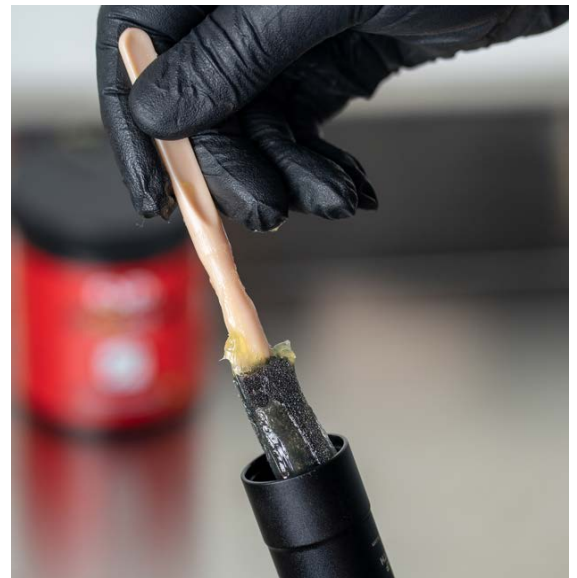

17. Put a small dab of grease on each of the pin grooves on the stanchion. This will hold the pins in place during installation.

18. Place pins into the greased pin grooves on the stanchion.



19. Install split bushing onto bottom of stanchion.



20. Slide stanchion with bushing and pins into lower tube. Pay attention to orientation of stanchion relative to lower tube - the flats on the top of the stanchion are the left and right sides, while the lower tube laser markings are located on the backside. Ensure that pins engage into the lower tube channels without binding. Slide stanchion to full extension, check for any binding or excess lash.

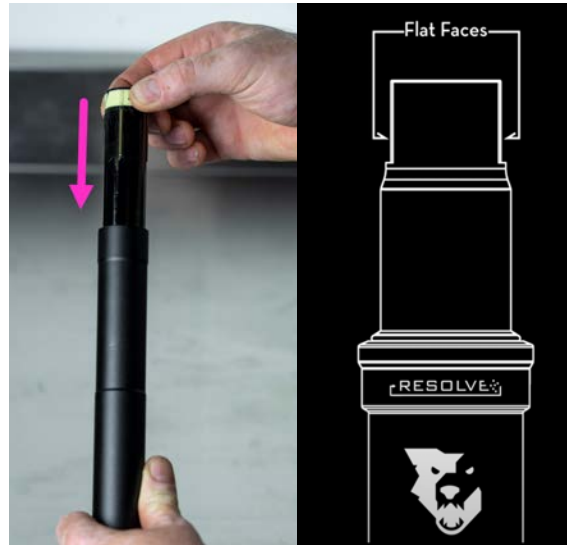

21. Install cartridge into housing assembly. Push firmly on end of actuator until cartridge is full seated (audible thud upon engagement).



22. Check that foam air filter is seated in place, and install plastic filter retaining ring. Use a pick to push the retaining ring into position, ensuring that the split ends do not overlap (overlap will prevent installation of snap ring).
NOTE: filter should be replaced every year or 100 hours of use.

ENSURE ENDS OF RING DO NOT OVERLAP



23. Use internal snap ring pliers to install snap ring. Ensure that snap ring is fully seated into its gland (will typically have an audible snap sound when it fully seats and should rotate easily when pulled by one of the “ears”).



24. Install piston rod end-cap onto end of piston rod in orientation shown. Hold piston rod with 7mm open-end wrench, lightly torque end-cap using 13mm cone wrench. Do not over tighten.

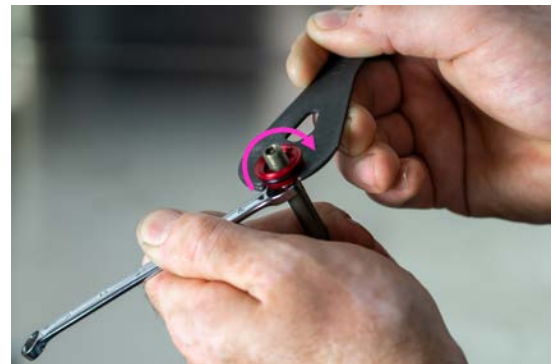

25. Extend stanchion until rod end-cap is seated into position. Place the 1.5x16.5mm o-ring onto the top of the rod end-cap. Inspect o-ring for damage and replace if necessary.

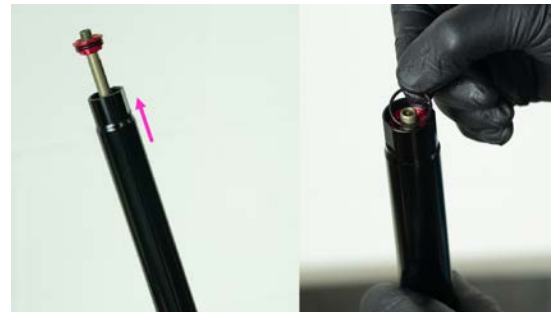

26. Apply a small amount of grease to inside of lower cradle, and install onto top of stanchion in orientation shown. Note the orientation relative to the laser markings on the lower tube - the RIGHT pivot block on the lower cradle assembly is marked with an R, while the laser marked graphics on the housing are on the backside of the post.



27. Apply small amount of grease to threads of lockring and install to secure lower cradle in place. Hold lower cradle using parallel-jaw pliers wrench, and use hollow XZN16 socket and $\frac{3}{8}$ "-drive torque wrench to torque lockring to 35 Nm (26 lb-ft).

NOTE: always use a torque wrench for lock ring installation. Under or over torquing this part is a potential safety issue



28. Reinstall air cap.

29. Reinstall saddle, upper cradle, spherical bolts and threaded barrels, and return saddle to original position. Torque bolts to 6 Nm.



30. Reconnect cable from dropper lever, and reinstall post into frame.



ADDING TRAVEL ADJUST SPACERS

Tools & parts required:

- Travel adjustment spacers (available from Wolf Tooth)
- 4mm hex key
- Hollow XZN16 Socket (included with purchase of post)
- Parallel-jaw pliers-wrench such as Knipex 86 03 250 (must have jaw capacity greater than 27mm)
 - If not available, an adjustable wrench or 27mm open-end wrench can be used, but the Knipex tool is preferable as it will not mar the faces of the lower cradle
- $\frac{3}{8}$ " drive torque wrench
- Lightweight suspension grease such as Buzzy's Slick Honey, Slickoleum, or RSP Slick Kick
- 7mm open-end wrench
- 13mm open-end wrench
- 15mm open-end wrench
- 13mm cone wrench
- Pick (straight or bent tip)
- Isopropyl Alcohol (90% or greater ideal)
- Low-lint or lint-free towels
- Internal snap-ring pliers, tip diameter 1-2mm
- Bench vise with soft (plastic) jaws
- Shock pump with bleed valve
- 50 mL graduated cylinder
- Red Line LikeWater Suspension fluid (in case of fluid loss during procedure)
- Safety glasses
- Nitrile gloves



Notes:

- *** Always wear safety glasses ***
- Contents of cartridge are under pressure. Ensure that all pressure is released from cartridge via the Schrader valve before attempting to disassemble.
- Always use caution to avoid scratching any of the mating part surfaces. Surface scratches will cause failure of seals.
- Maintain a clean workstation. Parts must be clean during assembly. Any foreign debris, hair, or lint can lead to premature failure of the system.

Procedure:

1. Fully extend dropper post. Use 4mm hex key to remove saddle bolts and cradle hardware.



2. Remove air cap, but do not release pressure from cartridge.

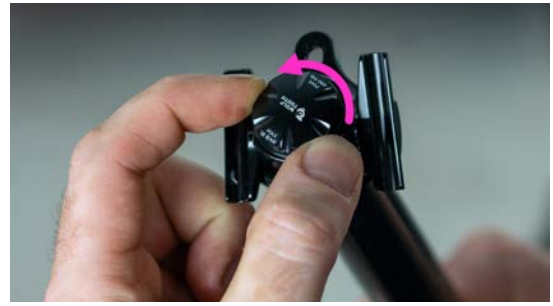

3. Use hollow XZN16 socket (included in dropper post packaging) to remove lockring. Hold lower cradle with parallel-jaw pliers wrench such as Knipex 86 03 250 (ideal), adjustable wrench, or 27mm open-end wrench.

NOTE: A parallel-jaw pliers-wrench such as the Knipex 86 03 250 or 86 03 300 is the best tool to use to hold the lower cradle when installing or removing lockring. While an adjustable wrench or a 27mm open-end wrench will work, they will leave marks on the ends of the wrench flats of the lower cradle. These marks will not affect function of the post.



4. Pull firmly upward to remove lower cradle from stanchion.



5. Slide stanchion down to expose piston rod end cap. Remove upper o-ring and set aside. Inspect o-ring for damage and replace if necessary.



6. Use 7mm open-end wrench to hold piston rod.
Remove rod-end cap using 13mm cone wrench.

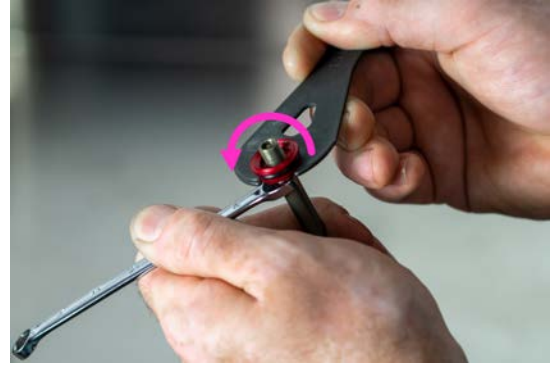

7. Use internal snap-ring pliers to remove snap-ring from bottom of post.



8. Use a pick to unseat and remove plastic air filter retainer ring.

9. Reinstall air cap onto end of piston rod. Push air cap/piston rod against workbench firmly to unseat cartridge from housing. Once unseated, remove air cap from piston rod, and slide cartridge out of housing.



10. Connect shock pump to Schrader valve at top of cartridge piston rod. With cartridge held vertically (Schrader valve at highest point), use bleed valve on shock pump to slowly release pressure from cartridge reservoir.

NOTE: It is common for some oil to come out of the Schrader valve when releasing pressure. Keep a towel on hand to catch any released oil, as well as spare oil in case of excessive loss.



11. Manually open the actuator valve at the bottom of the cartridge to release any remaining pressure contained in the cartridge cylinder into the reservoir. Release this pressure from the reservoir with the shock pump bleeder valve.

12. **IMPORTANT:** Verify that no remaining pressure is contained in the cartridge - actuator valve will remain in open state when all pressure has been released.



13. Begin unthreading upper cylinder cap. Hold cartridge by flats on lower cylinder cap using Knipex pliers wrench or 15mm open-end wrench. Use 13mm open-end wrench on upper cylinder cap to break cap loose, but do not yet fully remove.

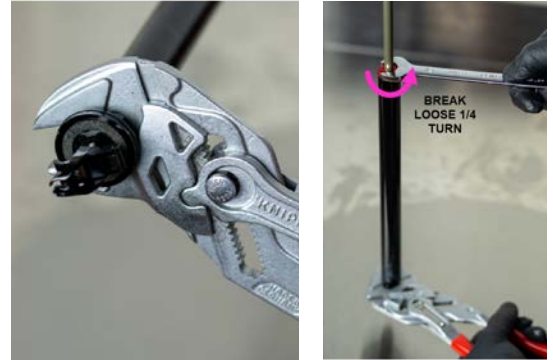

14. With plastic soft jaws in place, clamp actuator at bottom of cartridge in vise, holding the cartridge in an upright state. Be careful not to over-clamp.

NOTE: The cartridge must **never** be clamped around the reservoir tube. Clamping around reservoir will crush the tube and void warranty.

15. Use 13mm open-end wrench to continue unthreading upper cylinder cap, while holding the reservoir in place by hand.

NOTE: The reservoir must be held in place by hand during this process. Hold the reservoir down and keep from rotating while the cylinder cap is unthreaded. If reservoir is not held in place, it will potentially unseat from its lower seal, causing fluid to spill. A gap should form between the upper cylinder cap and the top of the reservoir while unthreading.

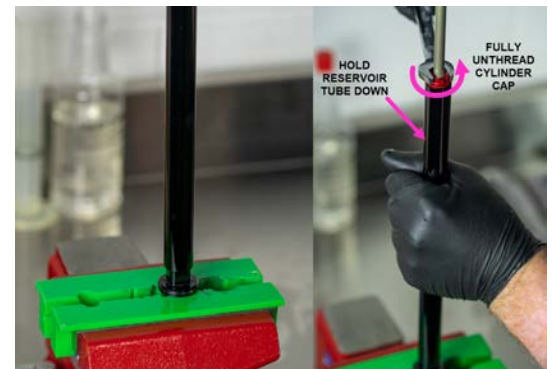

16. Slide cylinder cap up on the piston rod.



17. Install travel adjust spacers by clipping them onto piston rod below the cylinder cap. Each spacer will reduce travel by 5mm.

18. If no fluid was lost during depressurization of the cartridge, the cylinder cap may be reinstalled without re-measuring fluid volume (go directly to step 19). If significant fluid was lost during depressurization (more than 1 ml), proceed to following steps:

- a. Pull piston rod assembly out from cartridge cylinder. Set aside on clean surface.
- b. Unclamp cartridge actuator from vise and pour fluid from cylinder/reservoir into graduated cylinder.
- c. Measure volume of fluid removed from cartridge and compare to fluid volume table. Note that addition of travel-reducing spacers **does not** affect required fluid volume.

TRAVEL	FLUID VOLUME
125mm	29mL
160mm	34mL
200mm	40mL

- d. Fluid should be clear or light yellow in tint, and should not have any visible suspended solids. If fluid appears discolored or contaminated, discard into waste oil container and replace.
- e. If fluid does not appear discolored or contaminated, top off with new fluid until target volume is reached. Pour fluid back into cylinder/reservoir of cartridge.
- f. Reinstall piston/rod assembly into cylinder.

19. Using 13mm open-end wrench, begin threading upper cylinder cap onto top of cylinder. Keep a hand on the outer reservoir tube, holding the tube down during this process. Thread cylinder cap only until light bottom-out contact is made.



20. Tighten cylinder cap using 13mm open-end wrench.
This step should be performed with cartridge removed from vise. Hold lower cap wrench flats during tightening with Knipex pliers wrench or 15mm open-end wrench. Tighten $\frac{1}{8}$ turn past contact.

*** **Do NOT over tighten the cap** ***

21. Attach shock pump to end of piston rod. Inflate cartridge to 250 PSI. Manually operate actuator valve to fully extend cartridge. Pressure will decrease during extension - top off pressure again to 250 PSI.

22. Clean any residual oil on outside surface of cartridge using Isopropyl alcohol and clean towel.

23. Install cartridge into housing assembly. Push firmly on end of actuator until cartridge is full seated (audible thud upon engagement).

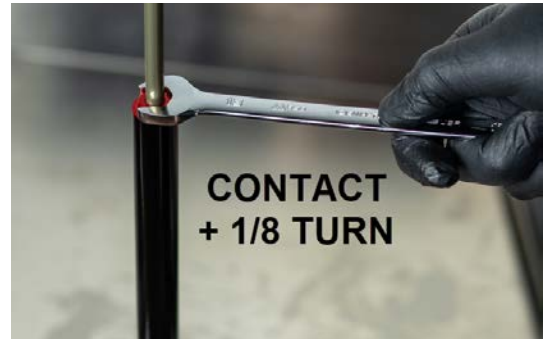

24. Check that foam air filter is seated in place, and install plastic filter retaining ring. Use a pick to push the retaining ring into position, ensuring that the split ends do not overlap (overlap will prevent installation of snap ring).

ENSURE ENDS OF RING DO NOT OVERLAP

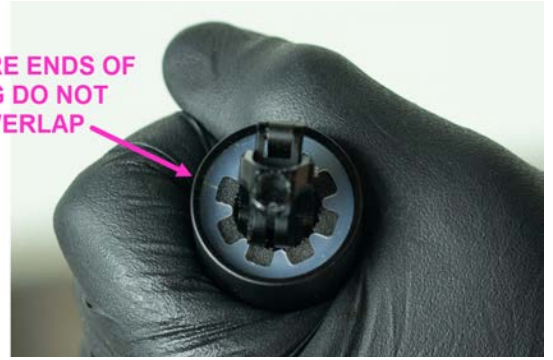

25. Use internal snap ring pliers to install snap ring. Ensure that snap ring is fully seated into its gland (will typically have an audible snap sound when it fully seats and should rotate easily when pulled by one of its "ears").



26. Install piston rod end-cap onto end of piston rod in orientation shown. Hold piston rod with 7mm open-end wrench, lightly torque end-cap using 13mm cone wrench.



27. Extend stanchion until rod end-cap is seated into position. Place the 1.5x16.5mm o-ring onto the top of the rod end-cap.



28. Apply a small amount of grease to inside of lower cradle, and install onto top of stanchion in orientation shown. Note the orientation relative to the laser markings on the lower tube - the RIGHT pivot block on the lower cradle assembly is marked with an R, while the laser marked graphics on the housing are on the backside of the post.



29. Apply small amount of grease to threads of lockring and install to secure lower cradle in place. Hold lower cradle using parallel-jaw pliers wrench, and use hollow XZN16 socket and $\frac{3}{8}$ "-drive torque wrench to torque lockring to 35 Nm (26 lb-ft).

*** always use a torque wrench for lock ring installation. Under or over torquing this part is a potential safety issue ***

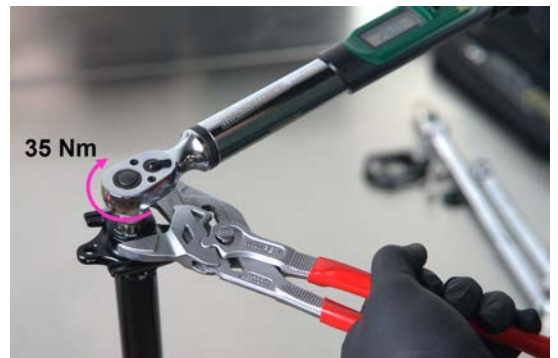

30. Reinstall air cap.



31. Reinstall saddle, upper cradle, spherical bolts and threaded barrels, and return saddle to original position. Torque bolts to 6 Nm.



32. Reconnect cable from dropper lever, and reinstall post into frame.



CARTRIDGE REBUILD

Tools and parts required:

- Replacement seals and parts as needed (available from Wolf Tooth)
- 4mm hex key
- 2.5mm hex key
- Hollow XZN16 Socket (included with purchase of post)
- Parallel-jaw pliers-wrench such as Knipex 86 03 250 (must have jaw capacity greater than 27mm)
 - If not available, an adjustable wrench or 27mm open-end wrench can be used, but the Knipex tool is preferable as it will not mar the faces of the lower cradle
- 3/8" drive torque wrench
- Lightweight suspension grease such as Buzzy's Slick Honey, Slickoleum, or RSP Slick Kick
- 7mm open-end wrench
- 13mm open-end wrench
- 14mm open-end wrench
- 15mm open-end wrench
- 13mm cone wrench
- Pick (straight or bent tip)
- Isopropyl Alcohol (90% or greater ideal)
- Low-lint or lint-free towels
- Internal snap-ring pliers, tip diameter 1-2mm
- Bench vise with soft (plastic) jaws
- Shock pump with bleed valve
- 50 mL graduated cylinder or syringe
- Red Line LikeWater suspension fluid & RSP No Stick Slip additive (alternatively, buy pre-mixed from Wolf tooth)
- Safety glasses
- Nitrile gloves
- 1.95mm gauge pin, or 1.5mm hex key

Notes:

- *** Always wear safety glasses ***
- Contents of cartridge are under pressure. Ensure that all pressure is released from cartridge via the Schrader valve before attempting to disassemble.
- Always use caution to avoid scratching any of the mating part surfaces. Surface scratches will cause failure of seals.
- Maintain a clean workstation. Parts must be clean during assembly. Any foreign debris, hair, or lint can lead to premature failure of the system.

Procedure:

1. Fully extend the dropper post before starting. Use 4mm hex key to remove saddle bolts and cradle hardware.
2. Remove air cap, but do not release pressure from cartridge.
3. Use hollow XZN16 socket (included in dropper post packaging) to remove lockring. Hold lower cradle with parallel-jaw pliers wrench such as Knipex 86 03 250 (ideal), adjustable wrench, or 27mm open-end wrench.
NOTE: A parallel-jaw pliers-wrench such as the Knipex 86 03 250 or 86 03 300 is the best tool to use to hold the lower cradle when installing or removing lockring. While an adjustable wrench or a 27mm open-end wrench will work, they will leave marks on the ends of the wrench flats of the lower cradle. These marks will not affect function of the post.
4. Pull firmly upward to remove lower cradle from stanchion.



5. Slide stanchion down to expose piston rod end cap. Remove upper o-ring and set aside.



6. Use 7mm open-end wrench to hold piston rod. Remove rod-end cap using 13mm cone wrench.

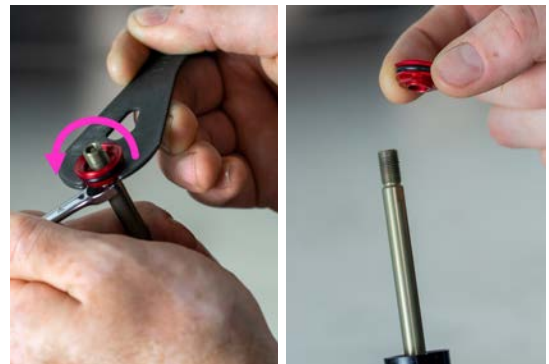

7. Use internal snap-ring pliers to remove snap-ring from bottom of post.



8. Use a pick to unseat and remove plastic air filter retainer ring.



9. Reinstall air cap on end of piston rod. Push end of piston rod against workbench firmly to unseat the cartridge. Remove the air cap and slide the cartridge out of the housing.



10. Connect shock pump to Schrader valve at top of cartridge piston rod. With cartridge held vertically (Schrader valve at highest point), use bleed valve on shock pump to slowly release pressure from cartridge reservoir.

NOTE: It is common for some oil to come out of the Schrader valve when releasing pressure. Keep a towel on hand to catch any released oil, as well as spare oil in case of excessive loss.



11. Manually open the actuator valve at the bottom of the cartridge to release any remaining pressure contained in the cartridge cylinder into the reservoir. Release this pressure from the reservoir with the shock pump bleeder valve.



12. **IMPORTANT** - Verify that no remaining pressure is contained in the cartridge - actuator valve will remain in open state when all pressure has been released.



13. Begin unthreading upper cylinder cap. Hold cartridge by flats on lower cylinder cap using Knipex pliers or 15mm open-end wrench. Use 13mm open-end wrench on upper cylinder cap to break cap loose ¼ turn, but do not yet fully remove.



14. With plastic soft jaws in place, clamp actuator at bottom of cartridge in vise, holding the cartridge in an upright state. Be careful not to over-clip.
NOTE: The cartridge must **never** be clamped around the reservoir tube. Clamping around reservoir will potentially crush the tube and void warranty.

15. Use 13mm open-end wrench to continue unthreading upper cylinder cap, while holding the reservoir in place by hand.
NOTE: The reservoir must be held in place by hand during this process. Hold the reservoir down and keep from rotating while the cylinder cap is unthreaded. If reservoir is not held in place, it will potentially unseat from its lower seal, causing fluid to spill. A gap should form between the upper cylinder cap and the top of reservoir tube as cap is unthreaded.

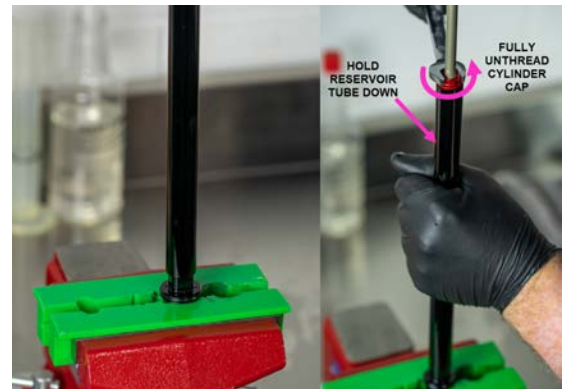

16. Remove piston and rod assembly from cylinder and set aside on clean work surface.



17. Remove cartridge from vise and pour fluid contents from cylinder and reservoir into a graduated cylinder. Fluid should be clear with a yellow tint, and should be free of suspended solids. Discolored or contaminated fluid should be discarded into a waste oil container.



18. Remove reservoir tube by holding lower cap and pulling firmly upward.

19. Remove cylinder from lower cap assembly using 14mm open-end wrench and Knipex pliers wrench or 15mm open-end wrench.



20. Remove valve body assembly from lower cap by gently gripping with pliers wrench and pulling upwards.

NOTE: Do not grip on or pull needle portion of valve body. Grip only on area shown.

NOTE: Occasionally the valve body will be removed from the lower cap with the cylinder tube. In this case, simply pull the valve body assembly out of the cylinder by hand.



21. Gently insert 2.5mm ball-end hex key through top of needle to extract poppet valve from valve body.

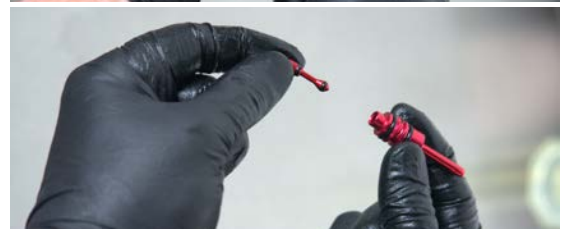

22. Remove and replace the two o-rings on the poppet valve (1.5 X 2.0, 1.5 X 2.5).



23. Remove and replace the two o-rings on the valve body (2.0 X 8.5).



24. Remove and replace the two o-rings on the lower cap/actuator.

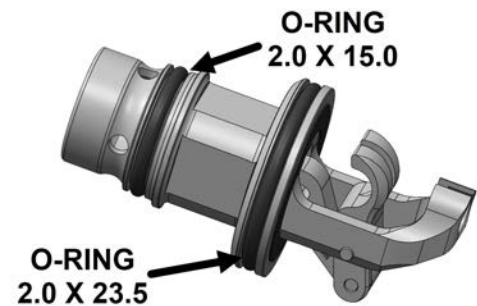

25. Remove the reticulated foam air filter. The filter will be replaced in a later step.



26. Remove the piston assembly from the piston rod. Hold piston assembly using a 1.95 mm gauge pin or 1.5mm hex key inserted through the hole in the piston coupler. Unthread piston rod from piston assembly using 7mm open-end wrench. Remove plastic top-out bumper ring and set aside.

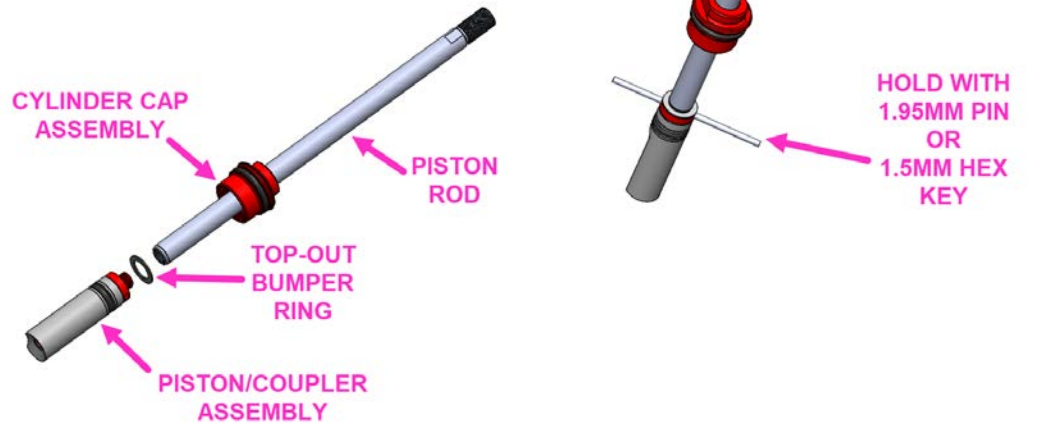

27. Replace the external piston o-ring.

NOTE: There is a small 1.5x4.5mm o-ring inside of the piston. This o-ring does not need to be replaced during routine service.

NOTE: Do not disassemble the piston/coupler assembly beyond removing the outer o-ring. Replacement piston/coupler assembly is available if needed.



28. Slide upper cylinder cap off of non-threaded end of piston rod.

NOTE: Sliding cylinder cap over threaded end of piston rod may result in damage to internal u-cup seal.

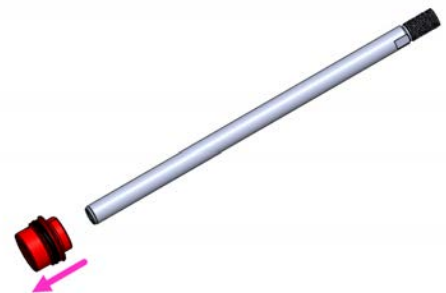

29. Replace outer o-ring on upper cylinder cap.

NOTE: Internal u-cup (blue) seal and plastic bushing should not be removed. If damage or excessive wear are present on seal or bushing, replacement cylinder cap assembly is available.

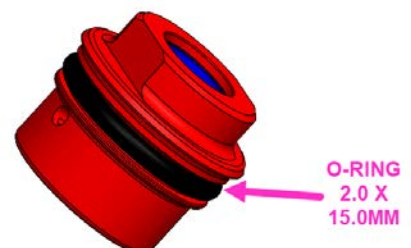

30. Apply suspension grease to inside of u-cup (blue seal) and bushing.



31. Slide cylinder cap assembly back onto non-threaded end of piston rod.

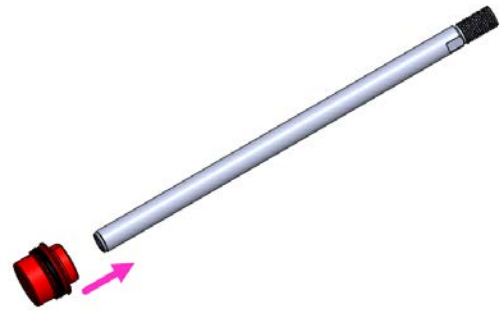

32. Place a new top-out bumper ring over threaded boss of piston coupler, and thread piston rod onto coupler. Ensure that top-out bumper is not pinched between piston rod and coupler. Top-out ring should turn freely after piston rod and coupler are attached.

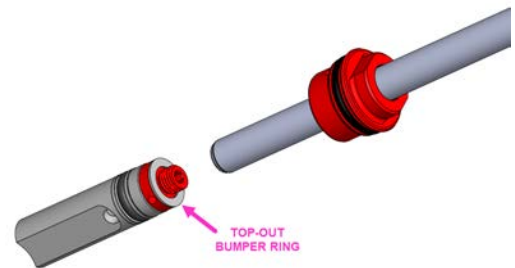

33. Use 1.95mm gauge pin or 1.5mm hex key to hold piston coupler. Using a 7mm open-end wrench or a crow's foot attachment on a torque wrench to torque piston rod to 2.0 Nm.

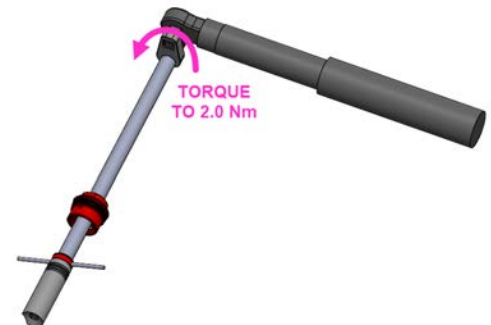

34. Apply suspension grease to o-rings on poppet valve. Insert poppet valve into valve body.

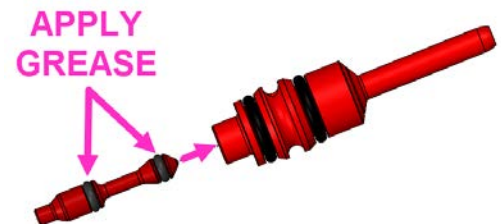

35. Apply suspension grease to o-rings on valve body. Install valve body into lower cap. Push valve body into lower cap until fully seated.

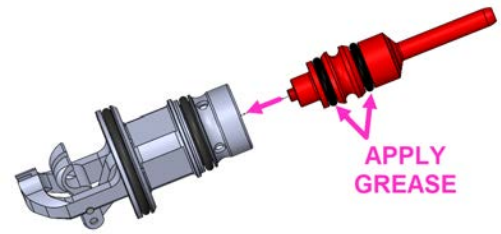

36. Place cylinder over valve body and thread into lower cap. Only one end of cylinder has wrench flats - this end should be threaded into lower cap.

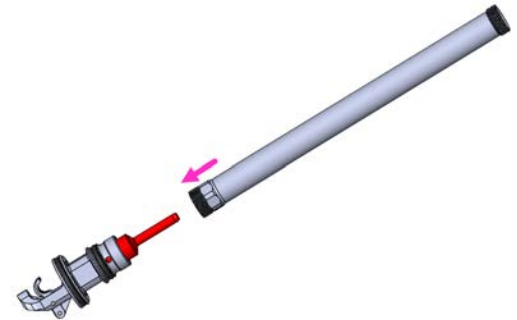

37. Hold lower cap using pliers wrench or 15mm open-end wrench. Using 14mm open-end wrench to tighten cylinder onto lower cap. Torque to 7.0 Nm.



38. Apply grease to o-rings on lower cap. Install reservoir tube onto lower cap, making sure tube is fully seated over o-ring.

39. Using graduated cylinder, measure fluid volume according to travel length of post (marked on outside of post housing).

NOTE: Addition of any travel-reducing spacers **does not** affect required fluid volume.



TRAVEL	FLUID VOLUME
125mm	29ml
160mm	34ml
200mm	40ml

40. Place assembly into soft jaws of vise, lightly gripping on faces of lower cap/actuator. Pour measured volume of fluid into cylinder/reservoir.

41. Apply grease to the external o-rings on the piston and the upper cylinder cap. Slowly insert piston into the cylinder.



42. Using 13mm open-end wrench, begin threading upper cylinder cap onto top of cylinder. Keep a hand on the outer reservoir tube, holding the tube down during this process. Thread cylinder cap only until light bottom-out contact is made.



43. Remove cartridge from vise soft-jaws. Holding lower cap with pliers-wrench, lightly tighten the upper cylinder cap using 13mm open-end wrench. Upper cap does not require much torque, only **contact plus 1/8 turn**.

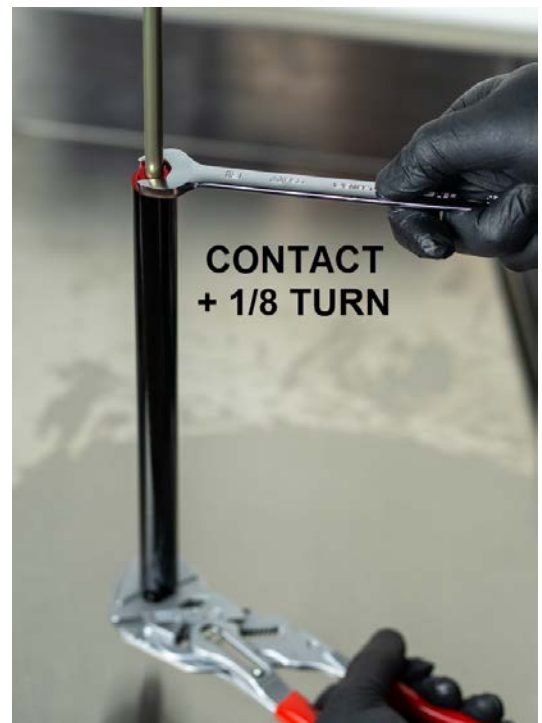

44. Attach shock pump to end of piston rod. Inflate cartridge to 250 PSI. Manually operate actuator valve to fully extend cartridge. Pressure will decrease during extension - top off pressure again to 250 PSI, and remove the shock pump.

45. Clean any residual oil on outside surface of cartridge using isopropyl alcohol and a clean towel.

46. Install cartridge into housing assembly. Push firmly on end of actuator until cartridge is full seated (audible thud upon engagement).

47. Install a new foam air filter into the bottom of the cartridge.



48. Install plastic filter retaining ring. Use a pick to push the retaining ring into position, ensuring that the split ends do not overlap (overlap will prevent installation of snap ring).



49. Use internal snap ring pliers to install snap ring. Ensure that snap ring is fully seated into its gland (will typically have an audible snap sound when it fully seats).



50. Install piston rod end-cap onto end of piston rod in orientation shown. Hold piston rod with 7mm open-end wrench, lightly torque end-cap using 13mm cone wrench.



51. Extend stanchion until rod end-cap is seated into position. Place a new 1.5x16.5mm o-ring onto the top of the rod end-cap, seating o-ring fully into position.



52. Apply a small amount of grease to inside of lower cradle, and install onto top of stanchion in orientation shown. Note the orientation relative to the laser markings on the lower tube - the RIGHT pivot block on the lower cradle assembly is marked with an R, while the laser marked graphics on the housing are on the backside of the post.



53. Apply small amount of grease to threads of locking and install to secure lower cradle in place. Hold lower cradle using parallel-jaw pliers wrench, and use hollow XZN16 socket and $\frac{3}{8}$ "-drive torque wrench to torque locking to 35 Nm.



54. Reinstall air cap.



55. Reinstall saddle, upper cradle, spherical bolts and threaded barrels, and return saddle to original position. Torque bolts to 6 Nm.

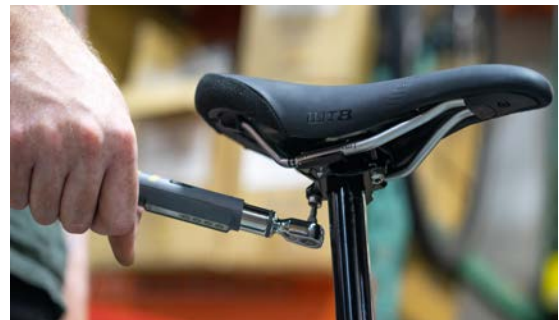

56. Reconnect cable from dropper lever, and reinstall post into frame.

