





# B-RAD *Bottle Relocation and Accessory Device*

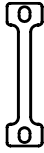

## DogBone Base Instructions

WOLF TOOTH | 3100 W PARK DR, BURNSVILLE, MN 55306 | www.wolftoothcomponents.com | 20180327 | B-RAD-DOG

### PARTS INCLUDED:

-  **BASE (DogBone)**  
2 through holes
-  **M5X16 FASTENER (QTY. 2)**  
"Long" screws
-  **M5X7.5 FASTENER (QTY. 2)**  
"Short" screws
-  **M5 NYLON WASHER (QTY. 2)**  
Optional "shims" provide clearance between frame and B-RAD base
-  **T25 L-WRENCH (QTY. 1)**  
Included with all B-RAD bases

**STEP 1.** Select appropriate B-RAD accessories to fit your frame and desired B-RAD configuration.

**STEP 2.** Attach slotted base to frame using long screws extended through B-RAD Accessory.

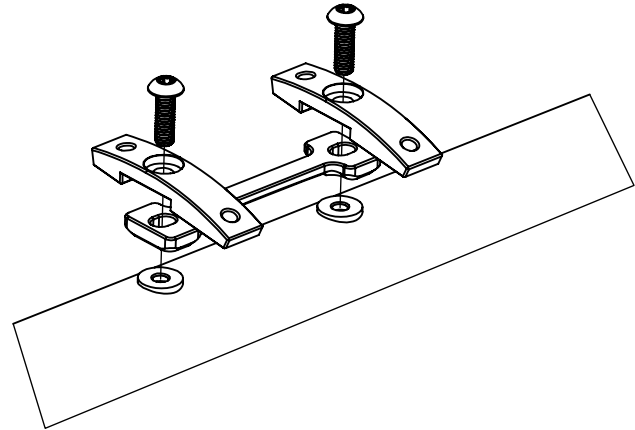

### B-RAD ACCESSORIES (sold separately)

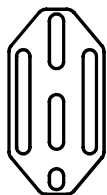

**BOTTLE CAGES  
BOTTLE ADAPTERS  
BAGS  
STRAP ADAPTERS**

**STEP 3.** Mount bottle cage and accessories to the DogBone base using "short" screws.

**STEP 4.** Tighten frame screws to manufacturers recommended torque (See notes). Check clearances with bottle cage and accessories installed before riding.

### TOOLS:

Hex wrenches  
T25 Torx Key

### COMPATIBILITY:

Bottle cages and B-RAD accessories.  
Frames and forks with at least 2 standard 64mm spaced bottle cage braze-ons.

### NOTES:

Torque short screws to 3-4 Nm and use light grease.  
Use frame manufacturer torque specs to attach base to frame using "long" screws.

