

SIERRA PARTS LIST

ITEM	PART#	DESCRIPTION	QUANTITY
a.	0005-58120-0000	Tube standoff, mounting, square, stainless SM	4
b.	0005-51220-0000	Screw, set, M5/6, socket	4
c.	0005-58200-0001	Screw, hex, socket, 8x25mm	4
d.	0005-57500-0001	Anchor, drywall	4
e.	0005-58120-0001	Bracket, wall mount	4
f.	0005-51200-0000	Screw, cross, countersunk, 2*40	4
g.	0005-51820-0000	Wallplate, stainless, with grommet and ground	1
h.	0005-51200-0001	Screw wallplate, stainless 6/32	2
i.	0005-58820-0000	Tube, stainless, round, electrical	1
j.	0005-51900-0000	Wrench, hex, 2.5	1
k.	0005-51900-0001	Wrench, hex, 6	1
n/a	AK05-58020-0000	Parts kit assembly, SM	1

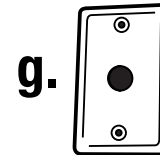

TOOLS REQUIRED



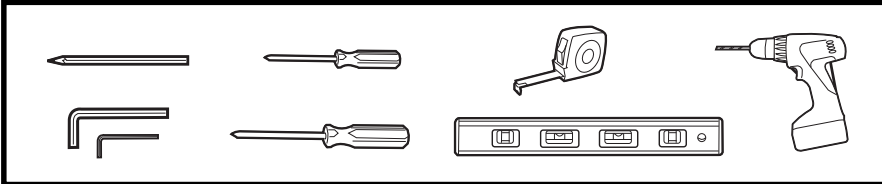



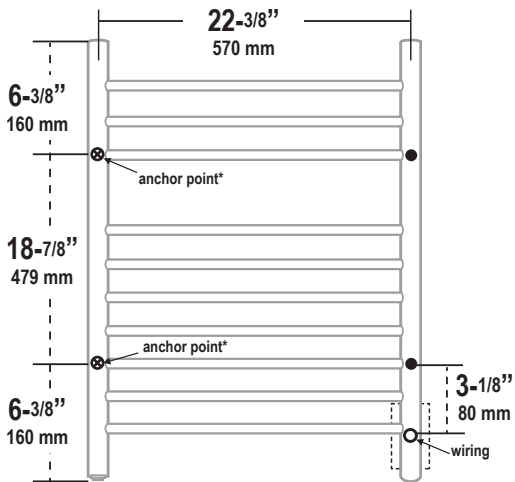

1-2.



INSTALLATION INSTRUCTIONS

- Review instructions carefully before installation
- Installation should be completed by a qualified person
- Please dispose of packaging in a responsible manner

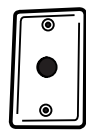

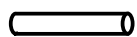
- a.  4 PCS
- b.  4 PCS
- c.  4 PCS
- d.  4 PCS
- e.  4 PCS
- f.  4 PCS
- g.  1 PCS
- h.  2 PCS
- i.  1 PCS

Optional Installation Method

- A. Attach tubing into desired positions on the towel warmer.
- B. Place towel warmer on the box (or a large sheet of paper) and lay on a flat surface with brackets facing downwards.
- C. Mark the location of the following:
 - The electrical collar
 - The location of the brackets
- D. Use the template as a guide to mark the wall with the correct locations of the four brackets, ensuring the following:
 - The electrical collar is lined up with the center of the electrical box.
 - At least two of the brackets are lined up with a wall stud.
 - The towel warmer is level.

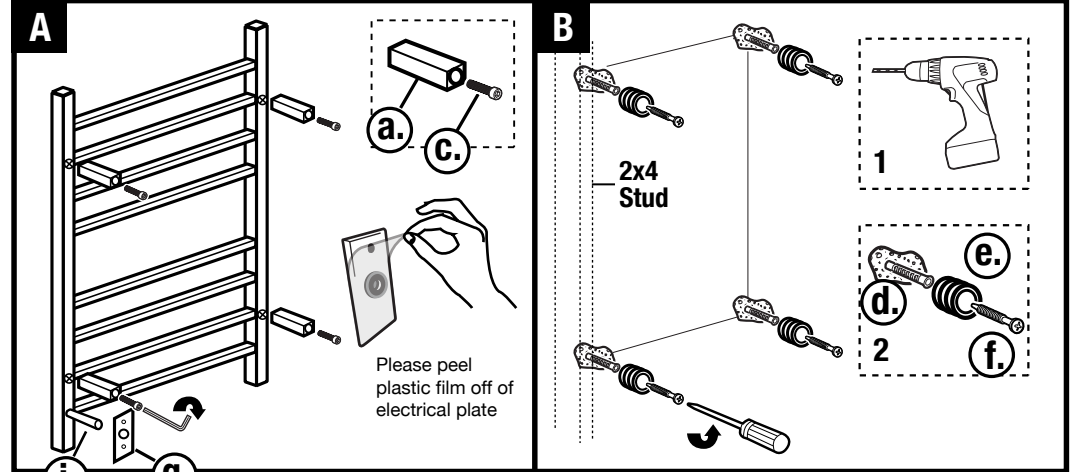

2-2.

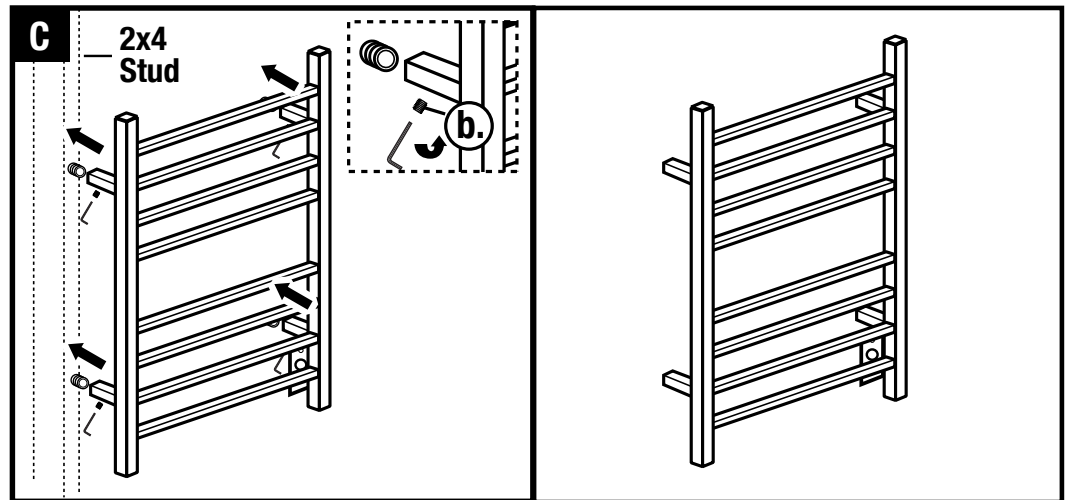

ELECTRICAL ROUGH-IN

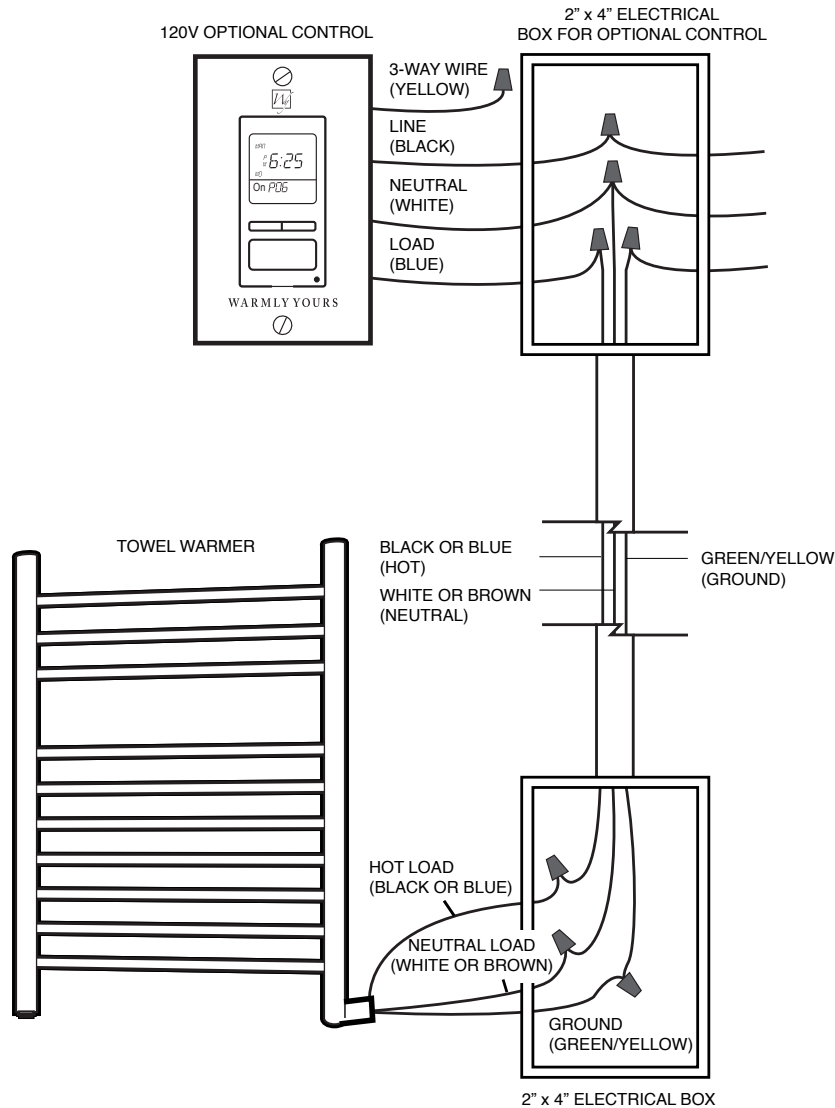

Operation:

Manual
You can operate your towel warmer by using the integrated on/off switch that is located at the bottom of one of the towel warmer's vertical stiles.

With a Control:
You may want to pair your towel warmer with a compatible WarmlyYours timer or switch. Make sure to refer to the installation manual of the control for proper operation and installation. If you have any questions, call 800-875-5285.

After installation is complete, connect the electric power and turn on the Power Switch, located on the bottom left of the unit. The unit will begin to heat. If the unit will not be used for an extended time, simply turn the unit off using the power switch.

1. Do not hook the unit up to a circuit until completely reading these instructions.
2. We recommend mounting the left vertical rail mounts to a stud.
3. This product is intended only for domestic use. Do not put the unit into water. Do not use in a sauna, shower cubicle or steam room. This product is for indoor use only.
4. If the heating wire inside the unit fails or becomes damaged, turn the unit OFF and contact WarmlyYours. Do NOT attempt to repair or remove the power switch or heating wire.
5. If you encounter any difficulties while installing your Towel Warmer, installation support is available by phone, 24/7 at (800) 875-5285.
5. If a return is necessary, please use original packaging if possible.

SAFETY INFORMATION

- Towel Warmers are designed to warm towels only and should not be used for any other purpose.
- Never stand, sit on or hang on the Towel Warmer unit.
- Never allow children to play on or with the Towel Warmer.
- Make sure that the electrical circuit breaker is shut off at the main panel before wiring or servicing your Towel Warmer.
- The Towel Warmer must be properly grounded.
- All wiring must be in accordance with the National Electrical Code (NEC) and Canadian Electrical Code (CEC) and should be performed by a licensed professional who is certified to do electrical wiring.
- Never place your Towel Warmer inside a shower, sauna or steam room.
- Never attempt to warm more than two (2) towels on the Towel Warmer at a time. Overloading the Towel Warmer will cause the unit to become extremely hot and may result in a burn if touched.
- Towel Warmers are cULus listed for use in US and Canadian markets.

CLEANING INFORMATION

Clean the Towel Warmer with a soft, non-abrasive, damp cloth while warm. Once the Towel Warmer has cooled, lightly polish with a soft dry cloth. Do not use abrasive cleaning powders, metal polish or chlorine based cleaners on any part of the Towel Warmer.

INSTALLATION

This appliance must be installed in accordance with the instructions in the manual and the NEC and CEC guidelines relating to electrical fixtures in bathrooms. The Towel Warmer must be on a GFCI protected circuit and be wired by a professional who is certified to do electrical wiring.