

CORDLESS HEDGE TRIMMER

Model No.: U20HT00-0A110

Supplier Model No. For Certification: D05003450-00000

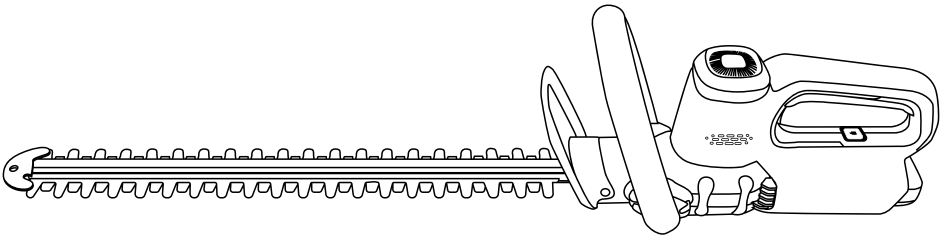

WARNING:

To reduce the risk of injury, the user must read and understand the user manual before using this product. Save this manual for future reference.

TABLE OF CONTENTS

Important Safety Instructions	02
Safety Symbols	07
Know Your Tool	10
Charging Your Battery	12
Assembly	14
Operation	17
Maintenance	20
Storage	21
Troubleshooting	22
Warranty	24

READ ALL INSTRUCTIONS!



WARNING: Some dust created by power sanding, sawing, grinding, drilling and other construction activities contains chemicals known to the state of California to cause cancer, birth defects or other reproductive harm. Some examples of these chemicals are:

- Lead from lead-based paints,
- Crystalline silica from bricks and cement and other masonry products, and
- Arsenic and chromium from chemically-treated lumber.

Your risk from these exposures varies, depending on how often you do this type of work. To reduce your exposure to these chemicals: work in a well-ventilated area, and work with approved safety equipment, such as those dust masks that are specially designed to filter out microscopic particles.

Important Safety Instructions



WARNING:

Only use the accessories that are provided with this product or the accessories approved by the manufacturer. Use of other accessories might increase the risk of injury. Follow the instructions in this manual to properly use the accessories.



WARNING:

This product can expose you to chemicals including lead and Di(2-ethylhexyl) phthalate (DEHP) which are known to the State of California to cause cancer and birth defects or other reproductive harm. For more information, go to www.P65Warnings.ca.gov.

The appliance is only to be used with the power supply unit provided with the appliance.

GENERAL POWER TOOL SAFETY WARNINGS



WARNING:

Read all safety warnings and instructions. Failure to follow the warnings and instructions may result in electric shock, fire and/or serious injury. Save all warnings and instructions for future reference.

The term “power tool” in the warnings refers to your mains-operated (corded) power tool or battery-operated (cordless) power tool.

1. WORK AREA SAFETY

- a. **Keep work area clean and well lit.** Cluttered or dark areas invite accidents.
- b. **Do not operate power tools in explosive atmospheres, such as in the presence of flammable liquids, gases or dust.** Power tools create sparks which may ignite the dust or fumes.
- c. **Keep children and bystanders away while operating a power tool.** Distractions can cause you to lose control.

2. ELECTRICAL SAFETY

- a. **Power tool plugs must match the outlet. Never modify the plug in any way. Do not use any adapter plugs with earthed (grounded) power tools.** Unmodified plugs and matching outlets will reduce risk of electric shock.
- b. **Avoid body contact with earthed or grounded surfaces, such as pipes, radiators, ranges and refrigerators.** There is an increased risk of electric shock if your body is earthed or grounded.
- c. **Do not expose power tools to rain or wet conditions.** Water entering a power tool will increase the risk of electric shock.
- d. **Do not abuse the cord. Never use the cord for carrying, pulling or unplugging the power tool. Keep cord away from heat, oil, sharp edges or moving parts.** Damaged or entangled cords increase the risk of electric shock.
- e. **When operating a power tool outdoors, use an extension cord suitable for outdoor use.** Use of a cord suitable for outdoor use reduces the risk of electric shock.
- f. **If operating a power tool in a damp location is unavoidable, use a residual current device (RCD) protected supply.** Use of an RCD reduces the risk of electric shock.

3. PERSONAL SAFETY

- a. **Stay alert, watch what you are doing and use common sense when operating a power tool. Do not use a power tool while you are tired or under the influence of drugs, alcohol or medication.** A moment inattention while operating power tools may result in serious personal injury.
- b. **Use personal protective equipment. Always wear eye protection.** Protective equipment such as dust mask, non-skid safety shoes, hard hat, or hearing protection used for appropriate conditions will reduce personal injuries.

- c. Prevent unintentional starting. Ensure the trigger is in the off- position before connecting to the power source, picking up or carrying the tool.** Carrying power tools with your finger on the switch or energizing power tools that have the switch on invites accidents.
- d. Remove any adjusting key or wrench before turning the power tool on.** A wrench or a key left attached to a rotating part of the power tool may result in personal injury.
- e. Do not overreach. Keep proper footing and balance at all times.** This enables better control of the power tool in unexpected situations.
- f. Dress properly. Do not wear loose clothing or jewellery. Keep your hair, clothing and gloves away from moving parts.** Loose clothes, jewelry or long hair can be caught in moving parts.
- g. If devices are provided for the connection of dust extraction and collection facilities, ensure these are connected and properly used.** Use of dust collection can reduce dust-related hazards.
- h. Do not let familiarity gained from frequent use of tools allow you to become complacent and ignore tool safety principles.** A careless action can cause severe injury within a fraction of a second.

4. POWER TOOL USE AND CARE

- a. Do not force the power tool. Use the correct power tool for your application.** The correct power tool will do the job better and safer at the rate for which it was designed.
- b. Do not use the power tool if it cannot be turned on/off by the switch.** Any power tool that cannot be controlled with the switch is dangerous and must be repaired.
- c. Disconnect the plug from the power source and/or remove the battery pack, if detachable, from the power tool before making any adjustments, changing accessories, or storing power tools.** Such preventive safety measures reduce the risk of starting the power tool accidentally.
- d. Store idle power tools out of the reach of children and do not allow persons unfamiliar with the power tool or these instructions to operate the power tool.** Power tools are dangerous in the hands of untrained users.
- e. Maintain power tools and accessories. Check for misalignment or binding of moving parts, breakage of parts and any other condition that may affect the power tool's operation. If damaged, have the power tool repaired before use.** Many accidents are caused by poorly maintained power tools.

- f. Keep cutting tools sharp and clean.** Properly maintained cutting tools with sharp cutting edges are less likely to bind and are easier to control.
- g. Use the power tool, accessories and tool bits etc. in accordance with these instructions, taking into account the working conditions and the work to be performed.** Use of the power tool for operations different from those intended could result in a hazardous situation.
- h. Keep handles and grasping surfaces dry, clean and free from oil and grease.** Slippery handles and grasping surfaces do not allow for safe handling and control of the tool in unexpected situations.

5. SERVICE (AC)

- a. Have your power tool serviced by a qualified repair person using only identical replacement parts.** This will ensure that the safety of the power tool is maintained.

6. BATTERY TOOL USE AND CARE (BATTERY TOOLS)

- a. a. Recharge only with the charger specified by the manufacturer.** A charger that is suitable for one type of battery pack may create a risk of fire when used with another battery pack.
- b. Use power tools only with specifically designated battery packs.** Use of any other battery packs may create a risk of injury and fire.
- c. When battery pack is not in use, keep it away from other metal objects, like paper clips, coins, keys, nails, screws or other small metal objects, that can make a connection from one terminal to another.** Shorting the battery terminals together may cause burns or a fire.
- d. Under abusive conditions, liquid may be ejected from the battery; avoid contact. If contact accidentally occurs, flush with water. If liquid contacts eyes, additionally seek medical help.** Liquid ejected from the battery may cause irritation or burns.
- e. Do not use a battery pack or tool that is damaged or modified.** Damaged or modified batteries may exhibit unpredictable behaviour resulting in fire, explosion or risk of injury.
- f. Do not expose a battery pack or tool to fire or excessive temperature.** Exposure to fire or temperature above 130 °C may cause explosion.
- g. Follow all charging instructions and do not charge the battery pack or tool outside the temperature range specified in the instructions.** Charging improperly or at temperatures outside the specified range may damage the battery and increase the risk of fire.

7.SERVICE

- a. **Have your power tool serviced by a qualified repair person using only identical replacement parts.** This will ensure that the safety of the power tool is maintained.
- b. **Never service damaged battery packs.** Service of battery packs should only be performed by the manufacturer or authorized service providers.

SAFETY WARNINGS FOR HEDGE TRIMMER

1. **1.Keep all parts of the body away from the cutter blade. Do not remove cut material or hold material to be cut when blades are moving. Make sure the switch is off when clearing jammed material. Blades coast after turn off.** A moment of inattention while operating the hedge trimmer may result in serious personal injury.
2. **2. Carry the hedge trimmer by the handle with the cutter blade stopped. When transporting or storing the hedge trimmer, always fit the cutting device cover.** Proper handling of the hedge trimmer will reduce possible personal injury from the cutter blades.
3. **3. When transporting or storing the hedge trimmer, always fit the blade cover.** Proper handling of the hedge trimmer will decrease the risk of personal injury from the blades.
4. **4. When clearing jammed material or servicing the unit, make sure all power switches are off and the power cord is disconnected.** Unexpected actuation of the hedge trimmer while clearing jammed material or servicing may result in serious personal injury.
5. **5. Hold the hedge trimmer by insulated gripping surfaces only, because the blade may contact hidden wiring or its own cord.** Blades contacting a "live" wire may make exposed metal parts of the hedge trimmer "live" and could give the operator an electric shock.
6. **6. Keep all power cords and cables away from cutting area.** Power cords or cables may be hidden in hedges or bushes and can be accidentally cut by the blade.
7. **7. Do not use the hedge trimmer in bad weather conditions, especially when there is a risk of lightning.** This decreases the risk of being struck by lightning.

SAFETY WARNINGS FOR BATTERY PACK

1. Do not modify or attempt to repair the battery pack. Do not dismantle, open or shred battery pack.
2. Do not expose a battery pack or appliance to fire or excessive temperature. Exposure to fire or temperature above 265°F (130°C) may cause explosion.
3. Do not short-circuit a battery pack. Do not store battery packs haphazardly in a box or drawer where they may short-circuit each other or be short-circuited by other metal objects. When battery pack is not in use, keep it away from other metal objects, like paper clips, coins, keys, nails, screws or other small metal objects, that can make a connection from one terminal to another. Shorting the battery terminals together may cause burns or fire.
4. Do not subject battery pack to mechanical shock.
5. Observe the plus (+) and minus (-) marks on the battery back and equipment and ensure correct use.
6. Keep battery pack out of the reach of children.
7. Always purchase the battery pack recommended by the device manufacturer for the equipment.
8. Keep battery pack clean and dry.
9. Wipe the battery pack terminals with a clean dry cloth if they become dirty.
10. Battery pack need to be charged before use. Always use the correct charger and refer to the manufacturer's instructions or equipment manual for proper charging instructions.
11. Do not leave battery pack on prolonged charge when not in use.
12. After extended periods of storage, it may be necessary to charge and discharge the battery pack several times to obtain maximum performance.
13. Battery pack gives its best performance when it is operated at normal room temperature (20°C—35°C).
14. Use only the battery pack in the application for which it was intended. Do not use a battery pack or appliance that is damaged or modified. Damaged or modified batteries may exhibit unpredictable behavior resulting in fire, explosion or risk of injury.
15. Remove the battery pack from the equipment when not in use.
16. Dispose of properly.
17. Do not handle the charger, including charger plug, or charger terminals with wet hands.
18. Do not charge the battery pack outdoors, in rain, or in wet locations.

- 19.Recharge only with the charger specified by the manufacturer. A charger that is suitable for one type of battery pack may create a risk of fire when used with another battery pack.
- 20.Use power tools only with specifically designated battery packs. Use of any other battery packs may create a risk of injury and fire.
- 21.Under abusive conditions, liquid may be ejected from the battery; avoid contact. If contact accidentally occurs, flush with water. If liquid contacts eyes, additionally seek medical help. Liquid ejected from the battery may cause irritation or burns.

Save these instructions. Refer to them frequently and use them to instruct others who may use this tool. If you lend this tool to someone else, also lend these instructions to them to prevent misuse of the product and possible injury.













Safety Symbols

The purpose of safety symbols is to attract your attention to possible danger. The safety symbols and the explanations with them deserve your careful attention and understanding. The symbol warnings do not, by themselves, eliminate any danger. The instruction and warnings they give are no substitutes for proper accident prevention measures.

The following signal words and meanings are intended to explain the levels of risk associated with this product.

SYMBOL	SIGNAL	MEANING
	WARNING	Indicates a hazardous situation, which, if not avoided, could result in death or serious injury.
	NOTICE	(Without Safety Alert Symbol) Indicates information considered important, but not related to a potential injury (e.g. messages relating to property damage).

Some of the following symbols may be used on this product. Please study them and learn their meaning. Proper interpretation of these symbols will allow you to operate the product better and safer.

Symbol	Description	Symbol	Description
	To reduce the risk of injury, user must read instruction manual.		Do not use in the rain or leave outdoors while it is raining.
	SAFETY ALERT - indicates a precaution, a warning or a danger.		Wear ear protection.
	Wear eye protection.		Wear dust mask.
	Indoor use only. Only use battery charger indoors.		Keep hands away.
	Wear protective gloves.		Do not burn the battery pack.
	Batteries may enter water cycle if disposed of improperly, which can be hazardous to the ecosystem. Do not dispose of old batteries as unsorted municipal waste.	 	Li-ion battery. This product has been marked with a symbol relating to 'separate collection' for all battery packs and battery pack. It will then be recycled or dismantled in order to reduce the impact on the environment. Battery packs can be hazardous for the environment and for human health since they contain hazardous substances.

Know Your Tool

1. Blade
2. Safety Guard
3. Front Switch Lever
4. Front Handle
5. U-BATTERY PLUS
6. Battery Release Button
7. Rear Handle
8. On/Off Switch
9. Blade Sheath
10. Battery Power Indicator Light
11. Battery Power Button
12. Two Way Type-C Port
13. USB-A Port
14. Charging Cable

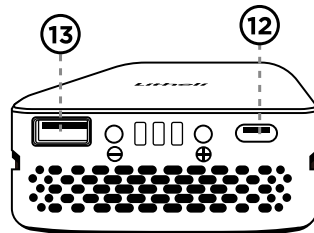
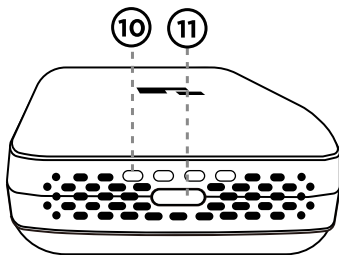
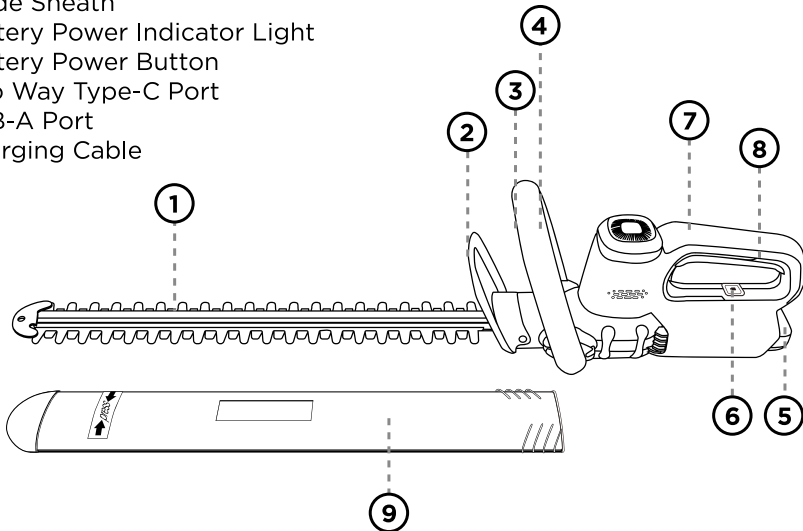
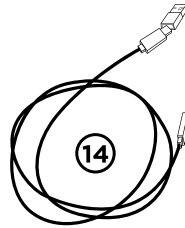

TECHNICAL DATA

Model No.	U20HT00-0A110
Voltage	20V  MAX*
Power Input	40W
No-Load Speed	18000rpm
Max. Cutting Length	20" (510mm)
Cutting Capacity	0.8" (20mm)
Battery	2000mAh Lithium-ion battery
Max. Charging Input*	45W
Charging Time	55min (Each)
Machine Weight (Battery Excluded)	5.6 lbs (2.53kg)

*Charger is not supplied with this product. It is recommended to prepare a 45w charger to charge with the provided charging cable.

ACCESSORIES

Model No.	U20HT00-0A110
Battery	1
Charging Cable	1
Blade Sheath	1

Litheli BATTERY (U-BATTERY PLUS)

NOTICE:

- Use only Litheli U-BATTERY PLUS for this appliance.
- This Litheli U-BATTERY PLUS is not resistant to water or dust. Please always keep this battery dry and clean when in use and storage. Do not allow water or moisture enter this battery.

- Benefiting from the innovative battery replacement design, the battery can be exchanged easily.

- The same lithium-ion electrochemistry which is for new energy vehicles.

- Can work as power bank and charge mobile phones and laptops.



Charging Your Battery

⚠ WARNING:

Do not use charger outdoors or expose it to wet or damp conditions. Water entering the charger will increase the risk of electric shock.

⚠ WARNING:

Charge the battery in a dry and ventilated room, far away from combustibles and ignition sources.

NOTICE:

Charger is not supplied with this appliance. You should prepare a 45W charger to work with the supplied charging cable for charging. Make sure the charger meets the requirement (Max. Charging Input) in Technical Data.

NOTICE:

Lithium-ion batteries are shipped partially charged. Before using it the first time, fully charge the battery.

BATTERY POWER INDICATOR

The battery supplied with this appliance is equipped with 4 battery power indicator lights which indicate the charge remained in the battery. Press the battery power button to check the remaining power.

The power level will be shown as following when charging:

- a. When only one indicator shows flashing, the battery needs to be charged.
- b. During the charging process, the indicators will light up one by one according to the charging situation, the indicator corresponding to the part that is full is always on, and the indicator of the part that is not fully charged flashes.
- c. All 4 indicator lights light up when the battery is fully charged.

NOTICE: If the battery power indicator lights 1&2 flash, it indicates an abnormal voltage or temperature situation.

Power Level	LED1	LED2	LED3	LED4
0-25%	Flashing	Off	Off	Off
25-50%	On	Flashing	Flashing	Flashing
50-75%	On	On	Flashing	Flashing
75-99%	On	On	On	Flashing
Fully Charged	On	On	On	On
Error	Flashing	Flashing	Off	Off

CHARGING PROCEDURE:

- a. Remove the battery from the appliance. During the charging process, the
- b. Use the supplied charging cable, insert the Type-C male connector at one end into the Two Way Type-C Port at the bottom of the battery.

- c. Connect the other end of the charging cable to the charger (not supplied), and connect the charger to the power supply for charging. Running light shows current battery level when charging.
- d. When all the battery power indicator lights stay on, the battery are fully charged. Remove the battery from the charger and disconnect them from the charging cable.

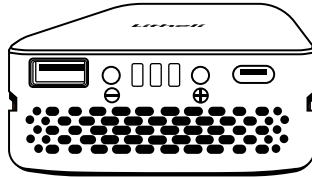

TIPS:

- a. The battery is not fully charged when leaving the factory, so be sure to fully charge the battery before first use.
- b. Do not charge the battery at temperatures below 5°C or above 40°C.
- c. When the working time of this appliance becomes significantly shorter, or the charging time becomes longer, it is recommended to replace the battery for a new one.
- d. The battery features overcharge protection, over-discharge protection and short circuit protection.
- e. The battery features overheating protection, and the output voltage for charging/powering devices which is operated in conformity with the instructions in this Manual is within a safe range, ensuring the safety for users.
- f. To avoid accidents, do not disassemble or modify the machine or the battery.

Assembly

WARNING:

To prevent accidental starting that could cause serious personal injury, always remove the battery pack from the tool when assembling parts.

⚠ WARNING:

Do not attempt to modify this tool or create accessories not recommended for use with this tool. Any such alteration or modification is misuse and could result in a hazardous condition leading to serious injury.

⚠ WARNING:

Do not attempt to start the tool before it has been completely assembled.

UNPACKING

- This product has been shipped completely assembled (battery pack not assembled), and requires no more assembly.
- Remove all the items from the carton. Make sure that all items listed in the parts list are included.
- Inspect the product carefully to make sure that no breakage or damage occurred during shipping.
- Do not discard the packing material until you have carefully inspected and satisfactorily operated the tool.
- If any parts are damaged or missing, please return the tool to the place of purchase.

REMOVING THE BLADE SHEATH

Pull the blade sheath completely out from the hedge trimmer.(Fig. 1)

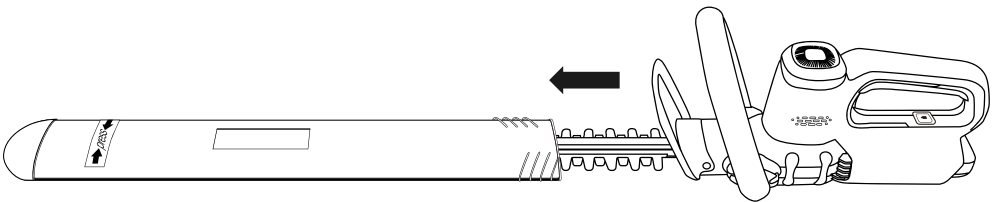

Fig. 1

INSTALLING OR REMOVING THE BATTERY PACK

NOTICE:

- Do not use excessive force to push the battery.
- This appliance will only run with battery installed. With the provided charging cable , you can easily charge the battery.

-INSTALLING

Push the battery into the battery compartment behind the handle, in the correct direction and position (the battery power indicator light is facing outwards), and push the battery to the end. (Fig. 2)

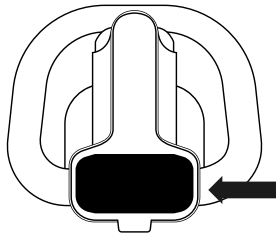

Fig. 2

- REMOVING

Press the battery release button, and the battery will pop out from the compartment automatically. Hold the battery and remove them from the machine. (Fig. 3)

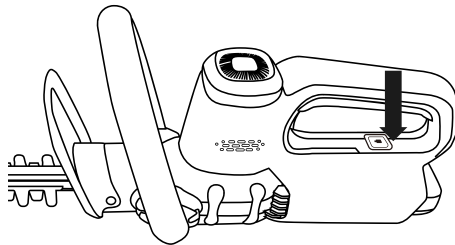

Fig. 3

Operation

INTENDED USE

This hedge trimmer is only designed for trimming hedges, bushes and shrubs.

⚠ WARNING:

Do not allow familiarity with this product to make you careless. Remember that a careless fraction of a second is sufficient to inflict serious injury.

⚠ WARNING:

Do not use any attachments or accessories not recommended by the manufacturer of this product. The use of attachments or accessories not recommended can result in serious personal injury.

⚠ WARNING:

Before operating the hedge trimmer, put on ANSI approved safety goggles and other safety gear (purchased by yourself). Maintain proper footing and balance and do not overreach.

STARTING/STOPPING THE HEDGE TRIMMER

- To turn on the hedge trimmer:

Hold the hedge trimmer with both hands, one hand on the rear handle and another hand on the front handle. Depress the on/off switch and hold it at the same time, grip the front handle and squeeze the front switch lever. Now the hedge trimmer is switched on. (Fig. 4)

NOTICE: The hedge trimmer will not run unless both the on/off switch and the front switch lever are depressed. So while using, the on/off switch and the front switch lever should always be depressed.

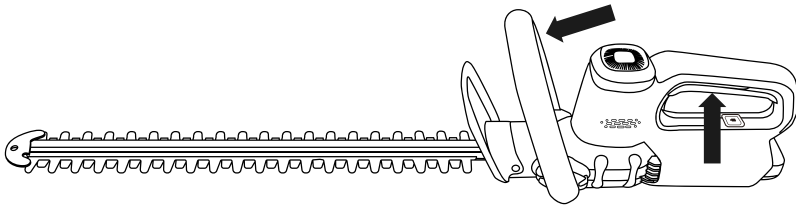

Fig. 4

- To stop the hedge trimmer:

Release either the on/off switch or the front switch lever, the hedge trimmer will stop. The blade will continue to move for a few seconds after switched off.

WARNING! TO PREVENT SERIOUS INJURY:

- Keep your hands on the front handle and rear handle at all times during operation.**
- Wait for the blade to stop completely before putting down the trimmer. The blade will briefly keep moving, even after the on/off switch and front switch lever were released.**
- Always remove the batteries from the hedge trimmer during work breaks and after finishing work.**

USING THE HEDGE TRIMMER

WARNING:

Before cutting an area, inspect it first and remove any foreign objects that could become thrown or entangled in the blades. Remove all decorations, lighting fixtures, and cords from the area. Always hold the trimmer with both hands on the front handle and the rear handle during operation and with the blade away from you before turning it on.

1. Mark off the hedge you will trim using stakes and marking string (purchased by yourself). Search for all branches thicker than 0.6 diameter and trim the large stems by using a hand saw or pruning saw (purchased by yourself).
2. When the area is clear, switch on the machine as shown above. Take off layers of plant material gradually using multiple passes. This will help avoid damaging the hedge, and prevent accidentally cutting thick branches or other objects hidden within the hedge.
3. When trimming new growth, use a wide sweeping action so that the stems are fed directly into the blade.
4. Allow the cutting blades to reach full speed before cutting. When operating, keep the cutting blades away from people and objects such as walls, large stones, trees, vehicles, etc.
5. If the blade stalls, **DO NOT TOUCH THE BLADE!** Release the front switch lever and on/off switch to stop the trimmer and remove the batteries before attempting. Clear jammed debris from the cutting blades.
6. Wear gloves when trimming thorny or prickly growth.
7. Do not attempt to cut stems that are too thick for the cutting blade.

8. Keep from trimming too much at one time. This can cause the blades to bind and slow, reducing the cutting efficiency.
9. To prevent accidents, release the on/off switch or the front switch lever to turn off the trimmer and remove its batteries after use.

TOP CUTTING (FIG. 5)

Use a wide sweeping motion. A slight downward tilt of the cutting blades in the direction of motion gives the best cutting results.

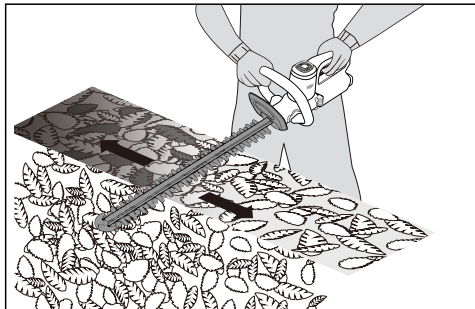

Fig. 5

SIDE CUTTING (FIG. 6)

When trimming the sides of the hedge, begin at the bottom and cut upwards, tapering the hedge inward at the top. This shape will expose more of the hedge, resulting in a more uniformed growth.

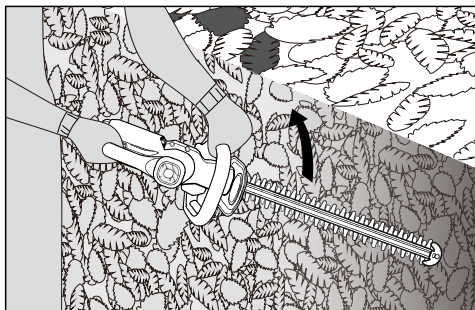

Fig. 6

⚠ WARNING:

Do not grasp the exposed cutting blades or cutting edges when picking up or holding the trimmer. Before clearing the debris, make sure the blades have totally stopped moving and the batteries have been removed.

Maintenance

⚠ WARNING:

When servicing, use only identical replacement parts. Use of any other parts may create a hazard or cause product damage. To ensure safety and reliability, all repairs should be performed by a qualified service technician.

⚠ WARNING:

To prevent serious personal injury, remove the batteries from the tool before servicing, cleaning, changing add-on attachments or removing material from the unit.

⚠ WARNING:

For the user's safety, worn or damaged parts must be replaced. Replace with original replacement parts only.

⚠ WARNING:

To prevent serious injury from appliance failure, do not use damaged equipment. If abnormal noise or vibration occurs, have the problem corrected before further use.

GENERAL MAINTENANCE TIPS

1. Do not attempt to repair the machine by yourself.
2. Check all the parts at frequent intervals for proper tightness to ensure that the machine is in safe working condition.
3. BEFORE EACH USE, inspect the general condition of the appliance. Check for:
 - loose hardware,
 - misalignment or binding of moving parts,
 - cracked or broken parts,
 - any other condition that may affect its safe operation.

CLEANING AND LUBRICATING

Regular cleaning and maintenance of your hedge trimmer will ensure efficiency and prolong the life of the product.

- After each use, wipe external surfaces of the appliance with clean dry cloth.
- Never wet or spray water on the machine. Do not use any detergents or solvents as these could cause irreparable damage to the trimmer. Chemicals can destroy the plastic parts.
- Use a soft brush to remove debris from cutting blade.
- Blade nicks that interfere with normal blade movement can be removed by using a file (purchased by yourself). Before doing this, remove the batteries.
- Lubricate the blade using a light weight machine oil. Before lubricating, ensure the batteries are removed. (Fig. 7)

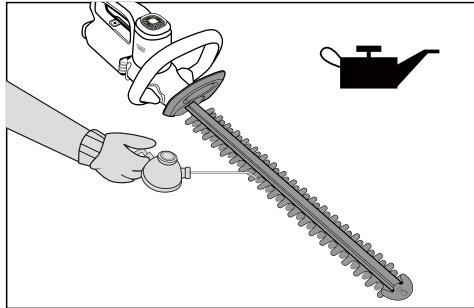

Fig. 7

Storage

Hedge trimmer:

1. Examine the cordless hedge trimmer thoroughly for worn, loose or damaged parts. Should you need to repair or replace a part, contact Litheli Customer Service for assistance.
2. Remove the batteries. Allow the motor to cool and clean the hedge trimmer before storing.
3. Cover the blade with the blade sheath. Store the cordless hedge trimmer indoors at room temperature in a locked, dry, well-ventilated place out of the reach of children to prevent unauthorized use and damage.

Battery:

- 1.** Do not expose your battery to water, rain or allow them to get wet. This could permanently damage the battery. Do not use oil or solvents to clean or lubricate your battery as the plastic casing can become brittle and crack, causing a serious risk of injury.
- 2.** Store the battery at room temperature away from moisture. Do not store in damp locations where corrosion of terminals may occur. As with other battery types, permanent capacity loss can result if the pack is stored for long periods of time at high temperatures (over 120°F/49°C).
- 3.** For longer service life of battery, recharge the battery every month when not in use.

For Battery-powered Tools

The ambient temperature range for the use and storage of tool and battery is 0°C-45°C (32°F-113°F).

The recommended ambient temperature range for the charging system during charging is 10°C-40°C (50°F-104°F). While charging, the battery and charger should be placed in a cool, dry indoor place with good ventilation.

Troubleshooting

The following table gives checks and actions that you can perform if your machine does not operate correctly. If these do not identify/remedy the problem, contact your service agent.

WARNING:

Switch off the machine and remove the batteries prior to any troubleshooting.

Problem	Possible causes	Remedy
Motor does not start.	Battery is not installed well.	Make sure the battery is fully inserted.
	Battery is depleted.	Charge the battery.
	Battery is too cold/hot.	Allow the battery to warm up/cool down.
	Two switch levers are not pressed simultaneously.	Depress the on/off switch and the front switch lever simultaneously.
	Blade is jammed.	Remove the batteries and clean out the debris from the cutting blades.
Battery cannot be charged.	The charging cable is not inserted well.	Re-insert the charging cable into the charger. Check if the charging indicator light is illuminating.
	Using a wrong charging cable.	Use the attached charging cable.

Tips:

1. Check and operate the appliance following this manual closely to avoid unnecessary failures.
2. If the appliance still fails to work, contact the Litheli service agent.

Warranty

Litheli WARRANTY POLICY FOR U20 PRODUCT

- For Litheli U20 product (battery excluded) used for personal and household purposes, 3-year limited standard warranty + 2-year limited extended warranty available upon product registration;
- For Litheli U20 battery used for personal and household purposes, 3-year limited warranty;

NOTICE: Litheli offers a Warranty Extension Service for U4 RIGEL product (battery excluded). Litheli U20 product (battery excluded) Warranty Extension is available only upon product registration. Register your U4 RIGEL product on Litheli OFFICIAL website to activate a 2-year limited extended warranty.

Please contact Litheli customer service at service@litheli.com any time you have questions or warranty claims.

LIMITED WARRANTY SERVICE

FOR FIVE (2-year limited extended warranty included) YEARS from the date of original retail purchase, this Litheli product (battery not included) is warranted against defects in material or workmanship. Defective product will receive free repair or will be exchanged.

FOR THREE YEARS from the date of original retail purchase, the Litheli battery is warranted against defects in material or workmanship. Defective product will receive free repair or be exchanged.

1. This warranty only covers Litheli products and batteries used for residential purposes.
2. This warranty does not cover the consumables such as, but not limited to, charging cable.
3. This warranty does not cover the damage resulting from modification, alteration or unauthorized repair.
4. This warranty only covers defects arising under normal usage and does not cover any malfunction, failure or defect resulting from misuse, abuse (including overloading of the product beyond capacity and immersion in water or other liquid), accidents, neglect or lack of proper installation, and improper maintenance or storage.

5. This warranty does not cover normal deterioration of the exterior finish including but not limited to scratches, dents, paint chips, or to any corrosion or discoloring by heat, abrasive and chemical cleaners.
6. This warranty applies only to the original purchaser from an authorized Litheli shop and may not be transferred.
7. This warranty does not require Litheli to repair or replace a Litheli lithium-ion battery/ies if the battery/ies present/s shortened runtime/working hour, reduced capacity, and/or weakened performance due to normal chemical age.

PRODUCT REGISTRATION

Please register your Litheli product on **Litheli OFFICIAL website.**

For better warranty services, we recommend that you register the product within 30 days from the date of the original retail purchase.

WARRANTY CLAIM

For warranty claims, please contact Litheli customer service. You will need to submit a registration document or proof of purchase in the form of a valid receipt that displays date and place of purchase. Replacement products do not come with a new warranty. The warranty of the products will continue from the date of the original purchase.

litheli tool

TOOLS FOR THE FUTURE



+1 (800) 323-8991



www.Litheli.com



service@litheli.com