



Valves and actuators.
SAUTER control units – for all of your requirements.

 **SAUTER**
Creating Sustainable Environments.

Passionately **innovative**, responsibly **energy-efficient**: SAUTER sets the technology standard for control units.

Our experience is evident in every detail, every product and every solution.

SAUTER is an experienced manufacturer and supplier of energy-efficient solutions for state-of-the-art building automation. Intelligent control, measuring and regulating technology reflects our core expertise and our success from more than 100 years of research, development and production. SAUTER products fulfil the highest demands from the automation level to the field level, and ensure optimum conditions in all living environments, as individual components and within systems.

Highly flexible for optimum results.

Our components are in demand throughout the world as modules in the heating, ventilation and air-conditioning industries. This applies equally to installers, end customers, wholesale dealers and production industry. They all highly value the precise control quality and efficient fitting of SAUTER products. Our current range of valves and actuators, with their in-built intelligence, covers all the requirements for reliable and long-lasting control units with just a few basic types. This makes the selection process logical and easy.

Getting the combination you want fast and easily.

The highest control quality results when valve and actuator encompass the same high level of technology and operational reliability. Simply select the basic valve type in this catalogue and use the precise data to define your specific combination of valve and actuator.



6-way ball valve

with electric rotary actuators



04 – 05

Unit valves

with thermal or motorised actuators



06 – 09

Dynamic regulating valves

with thermal or motorised actuators



10 – 13

Ball valves

with electric rotary actuators



14 – 19

Male thread and flanged valves

with electric linear actuators



20 – 29

Butterfly valves

with electric rotary actuators



30 – 31

Control valves

with electric rotary actuators



32 – 33

Retrofit

with electric actuators



34 – 39

Technical appendix

valve specification

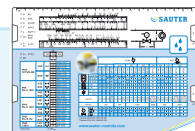

40 – 43

6-way ball valve with electric rotary actuator

Compact, reliable and easy to install: the SAUTER 6-way ball valve.

Heating and cooling with just one regulating ball valve.

The 6-way ball valve from SAUTER provides a compact, precise alternative for controlling heated and chilled ceilings and fan coils in 4-pipe systems. It doubles as a regulating valve or changeover ball valve. Conventional solutions may need as many as four 2-way valves, four actuators and two controllers. The SAUTER solution has just one 6-way ball valve and an actuator. Thanks to its compact design, it can be installed in any suspended ceiling.

Precise selection of the flow rate.

The 6-way ball valve, with a nominal diameter of DN 15 or DN 20, consists of two mechanically connected ball valves. The bores of the two balls are set at right angles, ensuring that the heating and cooling systems do not leak into each other. Varying apertures enable the maximum flow rate (Kvs) to be specified precisely. It is possible to select different Kvs values in a regulating ball valve for cooling and heating and flexibly adapt them to operating conditions. The result is more accurate and reliable control.

For more precise regulation, the 6-way ball valve from SAUTER can be combined with the SAUTER Valveco Compact (VDL) dynamic regulating valve. This is the ideal solution for hydronic balancing and provides more planning reliability, easier installation and increased energy efficiency.

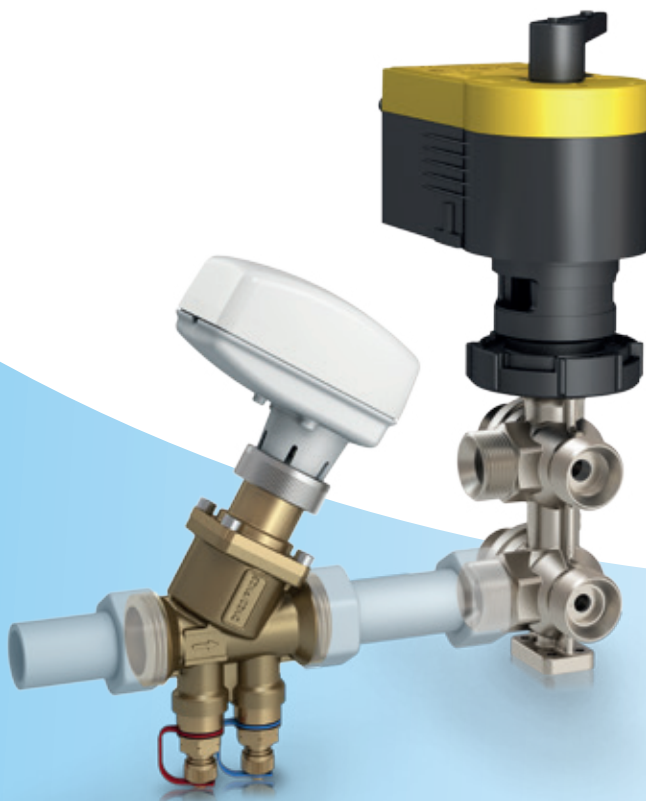



6-way ball valve in brass with electric rotary actuators



Model series		AKM			
Type		115			
Version		F120	F122	SF132	SF152
Voltage	230 V AC	•			
	24 V AC		•	•	•
	24 V DC			•	•
Positioning signal	2-point	•	•	•	•
	3-point	•	•	•	•
	0...10 V			•	•
	4...20 mA				•
Feedback	0...10 V			•	•
Running time [s]		120	120	35 60 120	6

6-way ball valve with male thread in cast brass, PN16

Type	DN	Connection	Kvs ⁽¹⁾	Orifice plate	Δp _{max} [bar]
6-way +5 °C...90 °C 	B2KL015F400	G 3/4"	0.25	supplied	2
			0.4		
			0.65		
			1		
			1.25		
	B2KL020F400	G 1"	0.25	0580240 102	2
			0.4	0580240 104	
			0.65	0580240 106	
			1	0580240 110	
			1.3	0580240 113	
			1.6	0580240 116	
			2.5	0580240 125	
			3.45	0580240 134	
			4.25	no	

¹⁾ Different apertures can be built into the same ball valve.

Important accessories for the 6-way ball valve

Type	Description
0378133 015	1 screw fitting, flat-sealing, G 3/4" - R 1/2"
0378133 115	2 screw fittings, flat-sealing, G 1" - G 1/2"
0378133 120	2 screw fittings, flat-sealing, G 1" - G 3/4"
0378133 125	2 screw fittings, flat-sealing, G 1" - G 1"
0378134 015	1 soldered fitting, flat-sealing, G 3/4" - Ø 15 mm
0560332 015	Strainer in gunmetal, -10...150 °C, mesh aperture 0.5 mm, DN 15
0560332 020	Strainer in gunmetal, -10...150 °C, mesh aperture 0.8 mm, DN 20
0560332 025	Strainer in gunmetal, -10...150 °C, mesh aperture 0.8 mm, DN 25
0580090 001	Pliers for changing orifice plate on B2KL DN 15
0580240 001	Fitting bracket for B2KL DN 015
0580240 002	Insulation shell for B2KL DN 15

The latest technology for **energy-efficient control precision.**

Actuator for unit valves with SAUTER quality.

The SAUTER AXT is the next consistent development in thermal actuator technology. It has pulse-pause control and is absolutely reliable, even with a small pulse ratio in the order of seconds. Together with valves with an equal-percentage characteristic, it can provide quasi-continuous control. It is used for controlling and regulating unit valves and underfloor distributors within room automation.

Installed in a flash.

The SAUTER AXT also provides automatic valve adjustment for 100% tightness, electrically protected inner workings and automatic stroke adjustment. Additionally, it has Low-Force-Locking, making it easy and quick to install. The SAUTER AXT is compatible with most valves of previous generations and those of third parties. This actuator for unit valves combines product intelligence which, with its wide range of accessories, enables it to be equipped for specific applications.



VUL/BUL unit valves in cast brass with AXT, AXS, AXM thermal or motorised actuators





Model series		AXT				AXT				AXS		AXM				
Type		211				211				215		217				
Version		F110 ¹⁾	F210	F112 ¹⁾	F212	HF110	HF210	HF112	HF212	F110M	F112M	SF122 ¹⁾	SF222 ¹⁾	F200	F202	SF402
Voltage	230 V AC	•	•			•	•			•				•		
	24 V AC			•	•			•	•			•	•			
	24 V DC			•	•			•	•							
Positioning signal	2-point	•	•	•	•	•	•	•	•	•	•			•	•	
	3-point													•	•	
	0...10 V											•	•			•
	4...20 mA															•
Pushing force/N ²⁾		115	110	115	110	115	110	115	110	115	115	110		120	120	
Characteristic	equal-percentage															•
Comb. V&A	linear													•	•	•
Direction of operation	normally closed	•		•		•		•		•	•	•		•	•	•
	normally open max. 110 N		•		•		•		•			•				
Auxiliary contacts						•	•	•	•							
Mech. adjustment										•	•					

¹⁾ Also available in black

²⁾ Pushing force max. 125 N for AXT 211/AXS 215 and closing dimension 13.5 mm

Unit valves in cast brass PN16 with equal percentage characteristic

		Type	DN	Connection	Kvs (m ³ /h)	Δp_{max} (bar)				
 2-way 2 °C...120 °C	VUL 010 F340	10	G ½B	0.16	4	4	4	4	4	
	VUL 010 F330	10	G ½B	0.4	4	4	4	4	4	
	VUL 010 F320	10	G ½B	0.63	4	4	4	4	4	
	VUL 010 F310	10	G ½B	1	4	4	4	4	3.8	
	VUL 010 F300	10	G ½B	1.6	4	4	4	4	3.8	
	VUL 015 F310	15	G ¾B	2.5	1.1	1.1	1.1	1.1	1.1	
	VUL 015 F300	15	G ¾B	3.5	1.1	1.1	1.1	1.1	1.1	
	VUL 020 F300	20	G 1B	4.5	1.1	1.1	1.1	1.1	1.1	
 3-way 2 °C...120 °C	BUL 010 F330	10	G ½B	0.4	1.7	1.7	1.7	1.7	1.7	
	BUL 010 F320	10	G ½B	0.63	1.7	1.7	1.7	1.7	1.7	
	BUL 010 F310	10	G ½B	1.0	1.7	1.7	1.7	1.7	1.7	
	BUL 010 F300	10	G ½B	1.6	1.7	1.7	1.7	1.7	1.7	
	BUL 015 F310	15	G ¾B	2.5	1.4	1.4	1.4	1.4	1.4	
	BUL 015 F300	15	G ¾B	4	1.2	1.2	1.2	1.2	1.2	
	BUL 020 F300	20	G 1B	5	1	1	1	1	1	
 With T by-pass 2 °C...120 °C	BUL 010 F430	10	G ½B	0.4	1.7	1.7	1.7	1.7	1.7	
	BUL 010 F420	10	G ½B	0.63	1.7	1.7	1.7	1.7	1.7	
	BUL 010 F410	10	G ½B	1	1.7	1.7	1.7	1.7	1.7	
	BUL 010 F400	10	G ½B	1.6	1.7	1.7	1.7	1.7	1.7	
	BUL 015 F410	15	G ¾B	2.5	1.4	1.4	1.4	1.4	1.4	
	BUL 015 F400	15	G ¾B	4	1.2	1.2	1.2	1.2	1.2	
	BUL 020 F400	20	G 1B	5	1	1	1	1	1	

VUT unit valves in cast brass with AXT, AXS, AXM thermal or motorised actuators



Model series		AXT				AXT				AXS		AXM				
Type		211				211				211		215		217		
Version		F110 ¹⁾	F210	F112 ¹⁾	F212	HF110	HF210	HF112	HF212	F110M	F112M	SF122 ¹⁾	SF222 ¹⁾	F200	F202	SF402
Voltage	230 V AC	•	•			•	•			•				•		
	24 V AC			•	•			•	•			•	•			
	24 V DC			•	•			•	•			•	•			
Positioning signal	2-point	•	•	•	•	•	•	•	•	•	•			•	•	
	3-point													•	•	
	0...10 V											•	•			•
	4...20 mA															•
Pushing force/N ²⁾		115	110	115	110	115	110	115	110	115	115	110	120	120	120	
Characteristic	equal-percentage															•
Comb. V&A	linear											•	•	•	•	•
Direction of operation	normally closed	•		•		•		•		•	•	•				
	normally open max. 110 N		•		•		•		•			•				
Auxiliary contact						•	•	•	•							
Mech. adjustment										•	•					

¹⁾ Also available in black

²⁾ Pushing force max. 125 N for AXT 211/AXS 215 and closing dimension 13.5 mm

Unit valves in cast brass PN16 with linear characteristic

	Type	DN	Connection	Kvs [m ³ /h]	Δp _{max} [bar]				
2-way 2 °C...120 °C 	VUT010F220	10	G ½B	0.2...0.63	2.5	2.5	2.5	2.5	2.5
	VUT010F210	10	G ½B	0.2...1	2.5	2.5	2.5	2.5	2.5
	VUT010F200	15	G ½B	0.2...1.6	2.5	2.5	2.5	2.5	2.5
	VUT015F210	15	G ¾B	0.3...2.5	1.8	1.8	1.8	1.8	1.8
	VUT015F200	15	G ¾B	1...3.5	1.8	1.8	1.8	1.8	1.8
	VUT020F200	20	G 1B	1...4.5	1	1	1	1	1

Important accessories for unit valves

Strainer in gunmetal, PN16, -10...150 °C



Type	DN	Description
0560332 015	15	ISO 228/1 – G 1/2, mesh aperture 0.5 mm
0560332 020	20	ISO 228/1 – G 3/4, mesh aperture 0.8 mm

Accessories for VUL and BUL unit valves



Type	DN	Description
0378133 010	10	1 threaded sleeve, R 3/8, flat-sealing, with cap nut and flat seal
0378133 015	15	1 threaded sleeve, R 1/2, flat-sealing, with cap nut and flat seal
0378133 020	20	1 threaded sleeve, R 3/4, flat-sealing, with cap nut and flat seal
0378134 010	10	1 solder nipple, Ø 12 mm, flat-sealing, with cap nut and flat seal
0378134 015	15	1 solder nipple, Ø 15 mm, flat-sealing, with cap nut and flat seal
0378134 020	20	1 solder nipple, Ø 22 mm, flat-sealing, with cap nut and flat seal
0378135 010	10	1 clamping-ring screw fitting for pipe Ø 15 mm
0378145 015	15	1 clamping-ring screw fitting for pipe Ø 15 mm, flat-sealing, 3/4 B
0378145 020	20	1 clamping-ring screw fitting for pipe Ø 22 mm, flat-sealing, 1 B

Accessories for AXT 211 actuators

Type	Description
0550240 001	Removal-protection device for AXT/AXS 211 (prevents the unauthorised removal of the plug and actuator)
0550602 021	Plug with cable, white, 2 m, PVC H03VV, 2 x 0.50 mm ²
0550602 052	Plug with cable, white, 5 m, PVC H05VV, 2 x 0.75 mm ²
0550602 102	Plug with cable, white, 10 m, PVC H05VV, 2 x 0.75 mm ²
0550602 152	Plug with cable, white, 15 m, PVC H05VV, 2 x 0.75 mm ²
0550602 021B	Plug with cable, black, 2 m, PVC H03VV, 2 x 0.50 mm ²
0550602 052B	Plug with cable, black, 5 m, PVC H05VV, 2 x 0.75 mm ²
0550602 102B	Plug with cable, black, 10 m, PVC H05VV, 2 x 0.75 mm ²
0550602 013	Plug with cable, halogen-free, white, 1 m, Hal F H05Z1Z1, 2 x 0.50 mm ²
0550602 023	Plug with cable, halogen-free, white, 2 m, Hal F H05Z1Z1, 2 x 0.75 mm ²
0550602 053	Plug with cable, halogen-free, white, 5 m, Hal F H05Z1Z1, 2 x 0.75 mm ²
0550602 103	Plug with cable, halogen-free, white, 10 m, Hal F H05Z1Z1, 2 x 0.75 mm ²
0550120 022	White plug with integrated LED, 24 V, lights up in blue, cable 2 m, PVC H03VV, 2 x 0.50 mm ²
0550120 052	White plug with integrated LED, 24 V, lights up in blue, cable 5 m, PVC H03VV, 2 x 0.75 mm ²

Accessories for AXS 215 actuators

Type	Description
0550240 001	Removal-protection device for AXT/AXS 2 (prevents the unauthorised removal of the plug and actuator)
0550423 121	Continuous control NC, cable white, 2 m, PVC H03, 3 x 0.22 mm ²
0550423 221	Continuous control NO, cable white, 2 m, PVC H03, 3 x 0.22 mm ²
0550423 151	Continuous control NC, cable white, 5 m, PVC H03, 3 x 0.22 mm ²
0550423 251	Continuous control NO, cable white, 5 m, PVC H03, 3 x 0.22 mm ²
0550423 121B	Continuous control NC, cable black, 2 m, PVC H03, 3 x 0.22 mm ²
0550423 221B	Continuous control NO, cable black, 2 m, PVC H03, 3 x 0.22 mm ²
0550423 151B	Continuous control NC, cable black, 5 m, PVC H03, 3 x 0.22 mm ²
0550423 123	Continuous control NC, cable halogen-free, white, 2 m, H03, 3 x 0.22 mm ²
0550423 153	Continuous control NC, cable halogen-free, white, 5 m, H03, 3 x 0.22 mm ²

Accessories for AXM 217 actuators

Type	Description
0550603 001	Cable 24 V, PVC, plug-in, 3 m long
0550603 002	Cable 24 V, PVC, plug-in, 7 m long
0550603 003	Cable 230 V, PVC, plug-in, 3 m long
0550603 004	Cable 230 V, PVC, plug-in, 7 m long
0550603 005	Cable 24 V, halogen-free, plug-in, 3 m long
0550603 006	Cable 24 V, halogen-free, plug-in, 7 m long
0550603 007	Cable 230 V, halogen-free, plug-in, 3 m long
0550603 008	Cable 230 V, halogen-free, plug-in, 7 m long

Accessories for AXM 217S actuators

Type	Description
0550603 009	Cable 24 V, PVC, plug-in, 3 m long
0550603 010	Cable 24 V, PVC, plug-in, 7 m long
0550603 011	Cable 24 V, halogen-free, plug-in, 3 m long
0550603 012	Cable 24 V, halogen-free, plug-in, 7 m long

Dynamic regulating valves with thermal or motorised actuators

SAUTER Valveco: **The all-rounder valve.**

Compensate pressure fluctuations. Adjust hydraulic relationships.

SAUTER Valveco valves are indispensable when it comes to ensuring a hydraulically balanced installation. These regulating valves are genuine all-rounders, combining three functions in a single compact valve, whether the requirement is to simply block a volume flow or continuously keep a defined flow rate constant. SAUTER Valveco reliably compensates pressure fluctuations and, acting as a variable resistance, maintains hydraulically adjusted conditions in your installation. Together with the AXT/AXS thermal or motorised actuators, this is the future-oriented valve for a wide range of heating and cooling applications.

Little installation and maintenance work required.

Thanks to the 3-in-1 design, you reduce the total number of valves needed and thus the labour time for installation and maintenance. The automatic hydronic balancing means that no manual recalibration is necessary. To make it easier to check and set the optimal differential pressure on site, SAUTER Valveco is available with pressure measurement nipples.

Our multi-function valves ensure exact temperature control and a precise control characteristic. This guarantees that there is no excess supply and increases the energy efficiency of your installation.



SAUTER Valvec/Valvec compact VCL/VDL dynamic regulating valves with AXT, AXS, AXM thermal or motorised valve actuators





Model series		AXT		AXT		AXT		AXS	AXM		
Type		211		211		211		215	217		
Version		F110 ¹⁾	F112 ¹⁾	HF110	HF112	F110M	F112M	SF122 ¹⁾	F200	F202	SF402
Voltage	230 V AC	•		•		•		•			
	24 V AC		•	•			•	•			
	24 V DC		•	•			•				•
Positioning signal	2-point	•	•	•		•	•		•	•	
	3-point								•	•	
	0...10 V							•			•
	4...20 mA										•
Pushing force/N ²⁾		115	115	115	115	115	115	115	120	120	
Characteristic	equal-percentage										•
Comb. V&A	linear							•	•	•	•
Direction of operation	normally closed	•	•	•	•	•	•	•			
	normally open max. 110 N										
Auxiliary contact				•	•						
Mech. adjustment						•	•				

¹⁾ Also available in black

²⁾ Pushing force max. 125 N for AXT 211/AXS 215 and closing dimension 13.5 mm

Dynamic regulating valve in dezincification resistant cast brass PN25 with linear characteristic

	Type	DN	Connection	Range (l/h)	Δp_{min} [bar]	Δp_{max} [bar]				
						4	4	4	4	4
2-way 0 °C...120 °C 	VDL010 F210	10	G ½B	30...200	0.14	4	4	4	4	4
	VDL010 F200	10	G ½B	65...370	0.14	4	4	4	4	4
	VDL015 F220	15	G ¾B	30...200	0.14	4	4	4	4	4
	VDL015 F210	15	G ¾B	65...370	0.14	4	4	4	4	4
	VDL015 F200	15	G ¾B	100...575	0.14	4	4	4	4	4
	VDL020 F220	20	G 1B	100...575	0.14	4	4	4	4	4
	VDL020 F210	20	G 1B	160...990	0.15	4	4	4	4	4
	VDL020 F200	20	G 1B	220...1330	0.15	4	4	4	4	4
	VDL010 F211	10	G ½B	30...200	0.14	4	4	4	4	4
	VDL010 F201	10	G ½B	65...370	0.14	4	4	4	4	4
	VDL015 F221	15	G ¾B	30...200	0.14	4	4	4	4	4
	VDL015 F211	15	G ¾B	65...370	0.14	4	4	4	4	4
	VDL015 F201	15	G ¾B	100...575	0.14	4	4	4	4	4
	VDL020 F221	20	G 1B	100...575	0.14	4	4	4	4	4
	VDL020 F211	20	G 1B	160...990	0.15	4	4	4	4	4
	VDL020 F201	20	G 1B	220...1330	0.15	4	4	4	4	4

Dynamic regulating valve in dezincification resistant cast brass PN16 with linear characteristic

	Type	DN	Connection	Range (l/h)	Δp_{min} [bar]	Δp_{max} [bar]				
						4	4	4	4	4
2-way 0 °C...120 °C 	VCL010 F210	10	G ½B	30...210	0.2	4	4	4	4	4
	VCL010 F200	10	G ½B	90...450	0.2	4	4	4	4	4
	VCL015 F220	15	G ¾B	30...210	0.2	4	4	4	4	4
	VCL015 F210	15	G ¾B	90...450	0.2	4	4	4	4	4
	VCL015 F200	15	G ¾B	150...1050	0.2	4	4	4	4	4
	VCL020 F210	20	G 1B	150...1050	0.2	4	4	4	4	4
	VCL020 F200	20	G 1B	180...1300	0.15	4	4	4	4	4
	VCL025 F200	25	G 1¼B	300...2000	0.15	4	4	4	4	4
	VCL032 F200	32	G 1¾B	600...3600	0.15	4	4	4	4	4

SAUTER Valveco VCL dynamic regulating valves with electrical linear actuators



Model series		AVM	
Type		115	
Version		F901	SF901
Voltage	230 V AC	•	
	24 V AC		•
	24 V DC		•
Positioning signal	2-point	•	•
	3-point	•	•
	0...10 V		•
Feedback	0...10 V		•
			•
Running time [s]		160	80 160
Pushing force [N]		500	500
Characteristic	equal-percentage		•
Combination	linear	•	•

Dynamic regulating valve in dezincification resistant cast brass PN16 with linear characteristic

	Type	DN	Connection	Range (l/h)	Δp_{\min} [bar]	Δp_{\max} [bar]
2-way	VCL 040 F200	40	G 2¼B	1500...7500	0.2	4
-10 °C...120 °C	VCL 050 F200	50	G 2¾B	2500...10000	0.2	4



Important accessories for Valveco/Valveco compact

Strainer in gunmetal, PN16, -10...150 °C

Type	DN	Description
	0560332 015	15 ISO 228/1 - G 1/2, mesh aperture 0.5 mm
	0560332 020	20 ISO 228/1 - G 3/4, mesh aperture 0.8 mm
	0560332 025	25 ISO 228/1 - G 1, mesh aperture 0.8 mm
	0560332 032	32 ISO 228/1 - G 1 1/4, mesh aperture 0.8 mm
	0560332 040	40 ISO 228/1 - G 1 1/2, mesh aperture 0.8 mm
	0560332 050	50 ISO 228/1 - G 2, mesh aperture 0.8 mm

Accessories for Valveco and Valveco compact

Type	DN	Description
	0378133 010	1 threaded sleeve, R 3/8, flat-sealing, with cap nut and flat seal
	0378133 015	1 threaded sleeve, R 1/2, flat-sealing, with cap nut and flat seal
	0378133 020	1 threaded sleeve, R 3/4, flat-sealing, with cap nut and flat seal
	0378133 025	1 threaded sleeve, R 1, flat-sealing, with cap nut and flat seal
	0378133 032	1 threaded sleeve, R 1 1/4, flat-sealing, with cap nut and flat seal
	0378134 010	1 solder nipple, Ø 12 mm, flat-sealing, with cap nut and flat seal
	0378134 015	1 solder nipple, Ø 15 mm, flat-sealing, with cap nut and flat seal
	0378134 020	1 solder nipple, Ø 22 mm, flat-sealing, with cap nut and flat seal
	0361951 040	1 screw fitting for male thread with flat seal
	0361951 050	1 screw fitting for male thread with flat seal

Accessories for AXT 211 actuators

Type	Description
0550240 001	Removal-protection device for AXT/AXS 2 (prevents the unauthorised removal of the plug and actuator)
0550602 021	Plug with cable, white, 2 m, PVC H03VV, 2 x 0.50 mm ²
0550602 052	Plug with cable, white, 5 m, PVC H05VV, 2 x 0.75 mm ²
0550602 102	Plug with cable, white, 10 m, PVC H05VV, 2 x 0.75 mm ²
0550602 152	Plug with cable, white, 15 m, PVC H05VV, 2 x 0.75 mm ²
0550602 021B	Plug with cable, black, 2 m, PVC H03VV, 2 x 0.50 mm ²
0550602 052B	Plug with cable, black, 5 m, PVC H05VV, 2 x 0.75 mm ²
0550602 102B	Plug with cable, black, 10 m, PVC H05VV, 2 x 0.75 mm ²
0550602 013	Plug with cable, halogen-free, white, 1 m, Hal F H05Z1Z1, 2 x 0.50 mm ²
0550602 023	Plug with cable, halogen-free, white, 2 m, Hal F H05Z1Z1, 2 x 0.75 mm ²
0550602 053	Plug with cable, halogen-free, white, 5 m, Hal F H05Z1Z1, 2 x 0.75 mm ²
0550602 103	Plug with cable, halogen-free, white, 10 m, Hal F H05Z1Z1, 2 x 0.75 mm ²
0550120 022	White plug with integrated LED, 24 V, lights up in blue, cable 2 m, PVC H03VV, 2 x 0.50 mm ²
0550120 052	White plug with integrated LED, 24 V, lights up in blue, cable 5 m, PVC H03VV, 2 x 0.75 mm ²

Accessories for AXS 215S actuators

Type	Description
0550240 001	Removal-protection device for AXT/AXS 2 (prevents the unauthorised removal of the plug and actuator)
0550423 121	Continuous control NC, cable white, 2 m, PVC H03, 3 x 0.22 mm ²
0550423 221	Continuous control NO, cable white, 2 m, PVC H03, 3 x 0.22 mm ²
0550423 151	Continuous control NC, cable white, 5 m, PVC H03, 3 x 0.22 mm ²
0550423 251	Continuous control NO, cable white, 5 m, PVC H03, 3 x 0.22 mm ²
0550423 121B	Continuous control NC, cable black, 2 m, PVC H03, 3 x 0.22 mm ²
0550423 221B	Continuous control NO, cable black, 2 m, PVC H03, 3 x 0.22 mm ²
0550423 151B	Continuous control NC, cable black, 5 m, PVC H03, 3 x 0.22 mm ²
0550423 123	Continuous control NC, cable halogen-free, white, 2 m, H03, 3 x 0.22 mm ²
0550423 153	Continuous control NC, cable halogen-free, white, 5 m, H03, 3 x 0.22 mm ²

Accessories for AXM 217 actuators

Type	Description
0550603 001	Cable 24 V, PVC, plug-in, 3 m long
0550603 002	Cable 24 V, PVC, plug-in, 7 m long
0550603 003	Cable 230 V, PVC, plug-in, 3 m long
0550603 004	Cable 230 V, PVC, plug-in, 7 m long
0550603 005	Cable 24 V, halogen-free, plug-in, 3 m long
0550603 006	Cable 24 V, halogen-free, plug-in, 7 m long
0550603 007	Cable 230 V, halogen-free, plug-in, 3 m long
0550603 008	Cable 230 V, halogen-free, plug-in, 7 m long

Accessories for AXM 217S actuators

Type	Description
0550603 009	Cable 24 V, PVC, plug-in, 3 m long
0550603 010	Cable 24 V, PVC, plug-in, 7 m long
0550603 011	Cable 24 V, halogen-free, plug-in, 3 m long
0550603 012	Cable 24 V, halogen-free, plug-in, 7 m long

Precise control and high flow rate: **2-way and 3-way ball valves** from SAUTER.

The perfection of a tried and tested principle.

The body of these ball valves from SAUTER is made of top-quality DZR brass. This enables them to be used in a wide range of applications. Due to the outstanding physical properties of the dezincification-resistant, chrome-plated brass ball with its polished surface, these valves enable the highest control accuracy and a modular, flexible concept.

Versatile and functions in a wide operating range:

- Combination with or without spring return
- Easy assembly without tools
- Plug the actuator onto the ball valve, turn the bayonet ring until it locks – that's it!
- The running time can be changed and the characteristic adjusted
- Detection of 2-point, 3-point or continuous actuators
- Anti-blocking function available
- Actuators with spring return fitted as "normally closed" or "normally open"

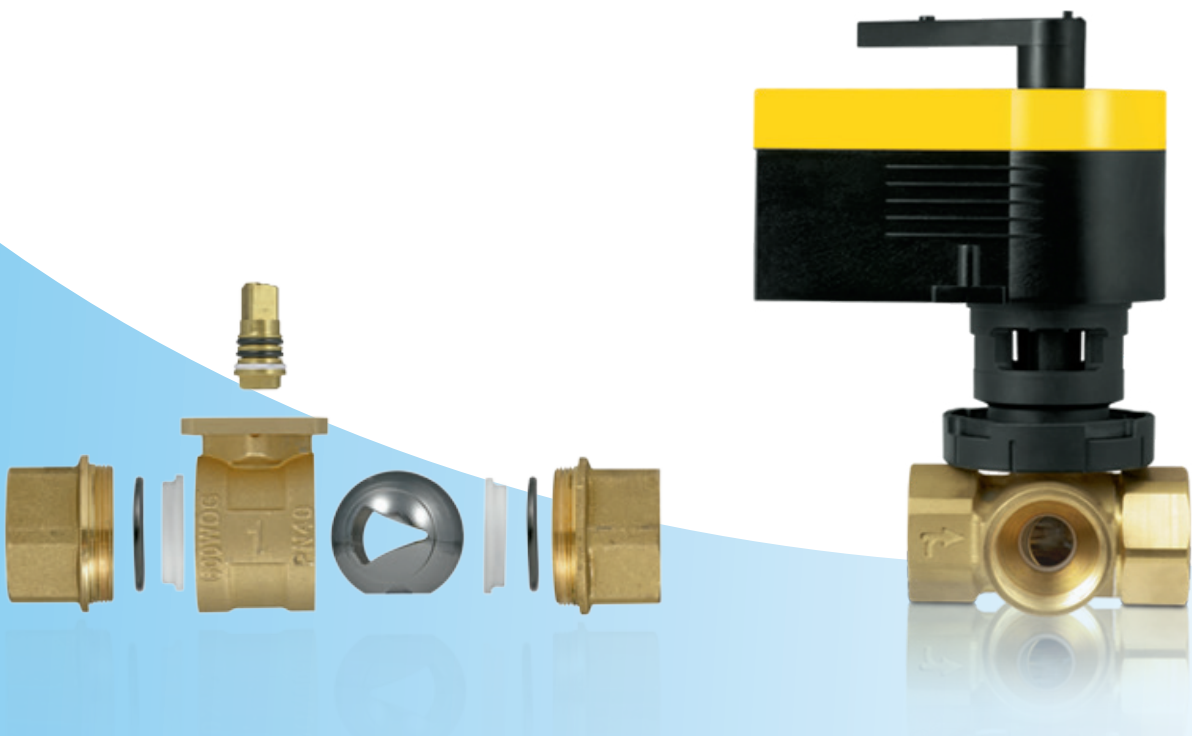



VKR/BKR regulating ball valve with female thread in DZR brass with electric rotary actuators



Model series		AKM				AKM				AKF			
Type		105				115				112		113	
Version		F100	F120	F122	SF132	F120	F122	SF132	SF152	F120	F122	F122	SF122
Voltage	230 V AC	•	•			•				•			
	24 V AC			•	•		•	•	•		•	•	•
	24 V DC				•			•	•		•	•	•
Positioning signal	2-point	•	•	•	•	•	•	•	•	•	•		
	3-point	•	•	•	•	•	•	•	•			•	
	0...10 V				•			•	•				•
	4...20 mA								•				
Feedback	0...10 V								•			•	
Running time [s]		30	120	120	60	120	120	60	6	90	90	90	90
Return time [s]					120			120		15	15	15	15
Characteristic	equal-percentage	•	•	•	•	•	•	•	•	•	•	•	•
	linear				•			•	•				
Spring return	without power, closes the ball valve									•	•	•	•
	without power, opens the ball valve									•	•	•	•

Ball valve with ISO female thread in DZR cast brass PN40 and equal percentage characteristic

	Type	DN	Connection	Kvs (m³/h)		Δp _{max} [bar]	
 2-way ball valve -10 °C...130 °C	VKR 015 F350-FF	15	Rp ½	1	1.8	3.5	3.5
	VKR 015 F340-FF	15	Rp ½	1.6	1.8	3.5	3.5
	VKR 015 F330-FF	15	Rp ½	2.5	1.8	3.5	3.5
	VKR 015 F320-FF	15	Rp ½	4	1.8	3.5	3.5
	VKR 015 F310-FF	15	Rp ½	6.3	1.8	3.5	3.5
	VKR 015 F300-FF	15	Rp ½	10	1.8	3.5	3.5
	VKR 020 F320-FF	20	Rp ¾	4	1.8	3.5	3.5
	VKR 020 F310-FF	20	Rp ¾	6.3	1.8	3.5	3.5
	VKR 020 F300-FF	20	Rp ¾	10	1.8	3.5	3.5
	VKR 025 F320-FF	25	Rp 1	6.3	1.8	3.5	3.5
	VKR 025 F310-FF	25	Rp 1	10	1.8	3.5	3.5
	VKR 025 F300-FF	25	Rp 1	16	1.8	3.5	3.5
	VKR 032 F320-FF	32	Rp 1¼	10	1.2	2.4	2.4
	VKR 032 F310-FF	32	Rp 1¼	16	1.2	2.4	2.4
	VKR 032 F300-FF	32	Rp 1¼	25	1.2	2.4	2.4
	VKR 040 F320-FF	40	Rp 1½	16	1.2	2.4	2.4
	VKR 040 F310-FF	40	Rp 1½	25	1.2	2.4	2.4
VKR 040 F300-FF	40	Rp 1½	40	1.2	2.4	2.4	
VKR 050 F320-FF	50	Rp 2	25	1.2	2.4	2.4	
VKR 050 F310-FF	50	Rp 2	40	1.2	2.4	2.4	
VKR 050 F300-FF	50	Rp 2	63	1.2	2.4	2.4	
 3-way ball valve -10 °C...130 °C	BKR 015 F340-FF	15	Rp ½	1.6	1.8	2	2
	BKR 015 F330-FF	15	Rp ½	2.5	1.8	2	2
	BKR 015 F320-FF	15	Rp ½	4	1.8	2	2
	BKR 015 F310-FF	15	Rp ½	6.3	1.2	2	2
	BKR 020 F320-FF	20	Rp ¾	4	1.8	2	2
	BKR 020 F310-FF	20	Rp ¾	6.3	1.8	2	2
	BKR 025 F310-FF	25	Rp 1	10	1.8	2	2
	BKR 032 F310-FF	32	Rp 1¼	16	1.2	2	2
	BKR 040 F310-FF	40	Rp 1½	25	1.2	2	2
	BKR 050 F310-FF	50	Rp 2	40	1.2	2	2



Cut-off / changeover ball valve with female thread in DZR brass with electric rotary actuators



Model series		AKM				AKM				AKF		ASF ¹⁾	
Type		105				115				112		112	
Version		F100	F120	F122	SF132	F120	F122	SF132	SF152	F120	F122	F220	F222
Voltage	230 V AC	•	•							•		•	
	24 V AC			•	•		•	•	•		•		•
	24 V DC				•						•		•
Positioning signal	2-point	•	•	•	•	•	•	•	•	•	•	•	•
	3-point	•	•	•	•	•	•	•	•			•	•
	0...10 V				•			•	•				
	4...20 mA								•				
Feedback	0...10 V							•	•				
					•								
Running time [s]		30	120	60 120	35 60 120	120	120	35 60 120	6	90	90	90	90
Return time [s]										15	15	15	15
Spring return		without power, closes the ball valve											
		without power, opens the ball valve											
Double contacts integrated												•	•

¹⁾ Mounting kit 0510240001 required

Cut-off / changeover ball valve with ISO female thread in DZR cast brass PN40

	Type	DN	Connection	Kvs (m ³ /h)	Δp _{max} [bar]			
Cut-off ball valve -10 °C...130 °C 	VKAI 015 F300	15	R _p ½	15	1.8	3.5	3.5	3.5
	VKAI 020 F300	20	R _p ¾	22	1.8	3.5	3.5	3.5
	VKAI 025 F300	25	R _p 1	22	1.8	3.5	3.5	3.5
	VKAI 032 F300	32	R _p 1¼	25	1.2	2.4	2.4	2.4
	VKAI 040 F300	40	R _p 1½	68	1.2	2.4	2.4	2.4
	VKAI 050 F300	50	R _p 2	96	1.2	2.4	2.4	2.4
Changeover ball valve 3-way Lbore -10 °C...130 °C 	BKLI 015 F300	15	R _p ½	15	1.8	2	2	2
	BKLI 020 F300	20	R _p ¾	22	1.8	2	2	2
	BKLI 025 F300	25	R _p 1	22	1.8	2	2	2
	BKLI 032 F300	32	R _p 1¼	25	1.2	2	2	2
	BKLI 040 F300	40	R _p 1½	68	1.2	2	2	2
	BKLI 050 F300	50	R _p 2	96	1.2	2	2	2
Changeover ball valve 3-way Tbore -10 °C...130 °C 	BKTI 015 F300	15	R _p ½	15	1.8	2	2	2
	BKTI 020 F300	20	R _p ¾	22	1.8	2	2	2
	BKTI 025 F300	25	R _p 1	22	1.8	2	2	2
	BKTI 032 F300	32	R _p 1¼	25	1.2	2	2	2
	BKTI 040 F300	40	R _p 1½	68	1.2	2	2	2
	BKTI 050 F300	50	R _p 2	96	1.2	2	2	2

VKRA/BKRA regulating ball valve with male thread in DZR brass with electric rotary actuators



Model series		AKM				AKM				AKF			
Type		105				115				112		113	
Version		F100	F120	F122	SF132	F120	F122	SF132	SF152	F120	F122	F122	SF122
Voltage	230 V AC	•	•			•				•			
	24 V AC			•	•		•	•	•		•	•	•
	24 V DC				•			•	•		•	•	•
Positioning signal	2-point	•	•	•	•	•	•	•	•	•	•		
	3-point	•	•	•	•	•	•	•	•			•	
	0...10 V				•			•	•				•
	4...20 mA								•				
Feedback	0...10 V							•				•	
Running time [s]		30	120	60	35	120	120	60	6	90	90	90	90
Return time [s]				120	120			120		15	15	15	15
Characteristic	equal-percentage	•	•	•	•	•	•	•	•	•	•	•	•
Combination	linear				•			•	•				
Spring return	without power, closes the ball valve									•	•	•	•
	without power, opens the ball valve									•	•	•	•

Ball valve with male thread in DZR cast brass PN40 and equal percentage characteristic

Type	DN	Connection	Kvs (m³/h)	ΔP _{max} [bar]	ΔP _{max} [bar]		
2-way ball valve -10 °C...130 °C	VKRA 015 F350	15	G 1"	1	1.8	3.5	3.5
	VKRA 015 F340	15	G 1"	1.6	1.8	3.5	3.5
	VKRA 015 F330	15	G 1"	2.5	1.8	3.5	3.5
	VKRA 015 F320	15	G 1"	4	1.8	3.5	3.5
	VKRA 015 F310	15	G 1"	6.3	1.8	3.5	3.5
	VKRA 020 F320	20	G 1¼"	4	1.8	3.5	3.5
	VKRA 020 F310	20	G 1¼"	6.3	1.8	3.5	3.5
	VKRA 020 F300	20	G 1¼"	10	1.8	3.5	3.5
	VKRA 025 F320	25	G 1½"	6.3	1.8	3.5	3.5
	VKRA 025 F310	25	G 1½"	10	1.8	3.5	3.5
	VKRA 025 F300	25	G 1½"	16	1.8	3.5	3.5
	VKRA 032 F320	32	G 2"	10	1.2	2.4	2.4
	VKRA 032 F310	32	G 2"	16	1.2	2.4	2.4
	VKRA 032 F300	32	G 2"	25	1.2	2.4	2.4
	VKRA 040 F320	40	G 2¼"	16	1.2	2.4	2.4
	VKRA 040 F310	40	G 2¼"	25	1.2	2.4	2.4
	VKRA 040 F300	40	G 2¼"	40	1.2	2.4	2.4
	VKRA 050 F320	50	G 2¾"	25	1.2	2.4	2.4
	VKRA 050 F310	50	G 2¾"	40	1.2	2.4	2.4
	VKRA 050 F300	50	G 2¾"	63	1.2	2.4	2.4
3-way ball valve -10 °C...130 °C	BKRA 015 F340	15	G 1"	1.6	1.8	2	2
	BKRA 015 F330	15	G 1"	2.5	1.8	2	2
	BKRA 015 F320	15	G 1"	4	1.8	2	2
	BKRA 015 F310	15	G 1"	6.3	1.8	2	2
	BKRA 020 F320	20	G 1¼"	4	1.8	2	2
	BKRA 020 F310	20	G 1¼"	6.3	1.8	2	2
	BKRA 025 F310	25	G 1½"	10	1.8	2	2
	BKRA 032 F310	32	G 2"	16	1.2	2	2
	BKRA 040 F310	40	G 2¼"	25	1.2	2	2
	BKRA 050 F310	50	G 2¾"	40	1.2	2	2



Cut-off / changeover ball valve in DZR brass with electric rotary actuators



Model series		AKM				AKM				AKF		ASF ¹⁾	
Type		105				115				112		112	
Version		F100	F120	F122	SF132	F120	F122	SF132	SF152	F120	F122	F220	F222
Voltage	230 V AC	•	•			•				•		•	
	24 V AC			•	•		•	•	•		•		•
	24 V DC				•			•	•		•		•
Positioning signal	2-point	•	•	•		•	•	•	•	•	•	•	•
	3-point	•	•	•	•	•	•	•	•			•	•
	0...10 V				•			•	•				
Feedback	4...20 mA								•				
	0...10 V				•			•	•				
Running time [s]		30	120	60	35	120	120	60	6	90	90	90	90
Return time [s]				120	120			120					
Spring return	without power, closes the ball valve									•	•	•	•
	without power, opens the ball valve									•	•	•	•
Double contacts integrated												•	•

¹⁾ Mounting kit 0510240001 required

Cut-off / changeover ball valve with ISO male thread in DZR cast brass PN40

	Type	DN	Connection	Kvs (m ³ /h)		Δp _{max} [bar]		
Cut-off ball valve -10 °C...130 °C 	VKAA 015 F300	15	G 1"	9	1.8	3.5	3.5	3.5
	VKAA 020 F300	20	G 1½"	17	1.8	3.5	3.5	3.5
	VKAA 025 F300	25	G 1½"	22	1.8	3.5	3.5	3.5
	VKAA 032 F300	32	G 2"	35	1.2	2.4	2.4	2.4
	VKAA 040 F300	40	G 2¼"	68	1.2	2.4	2.4	2.4
	VKAA 050 F300	50	G 2¾"	96	1.2	2.4	2.4	2.4
Changeover ball valve 3-way T-bore -10 °C...130 °C 	BKTA 015 F300	15	G 1"	8	1.8	2	2	2
	BKTA 020 F300	20	G 1½"	13	1.8	2	2	2
	BKTA 025 F300	25	G 1½"	13	1.8	2	2	2
	BKTA 032 F300	32	G 2"	25	1.2	2	2	2
	BKTA 040 F300	40	G 2¼"	49	1.2	2	2	2
	BKTA 050 F300	50	G 2¾"	73	1.2	2	2	2

Important accessories for ball valves

Strainer in gunmetal, PN16, -10...150 °C

Type	DN	Description
	0560332 015	15 ISO 228/1 - G 1/2, mesh aperture 0.5 mm
	0560332 020	20 ISO 228/1 - G 3/4, mesh aperture 0.8 mm
	0560332 025	25 ISO 228/1 - G 1, mesh aperture 0.8 mm
	0560332 032	32 ISO 228/1 - G 1 1/4, mesh aperture 0.8 mm
	0560332 040	40 ISO 228/1 - G 1 1/2, mesh aperture 0.8 mm
	0560332 050	50 ISO 228/1 - G 2, mesh aperture 0.8 mm

Accessories for VKx and BKx ball valves with female thread

Type	DN	Description
	0560283 015	1 screw fitting, flat-sealing, G 1B / Rp 1/2
	0560283 020	1 screw fitting, flat-sealing, G 1 1/4B / Rp 3/4
	0560283 025	1 screw fitting, flat-sealing, G 1 1/2B / Rp 1
	0560283 032	1 screw fitting, flat-sealing, G 2B / Rp 1 1/4
	0560283 040	1 screw fitting, flat-sealing, G 2 1/4B / Rp 1 1/2
	0560283 050	1 screw fitting, flat-sealing, G 2 3/4B / Rp 2

Accessories for VKx and BKx ball valves with male thread

Type	DN	Description
	0361951 015	1 screw fitting in brass for male thread with flat seal, G 1B / Rp 1/2
	0361951 020	1 screw fitting in brass for male thread with flat seal, G 1 1/4B / Rp 3/4
	0361951 025	1 screw fitting in brass for male thread with flat seal, G 1 1/2B / Rp 1
	0361951 032	1 screw fitting in brass for male thread with flat seal, G 2B / Rp 1 1/4
	0361951 040	1 screw fitting in brass for male thread with flat seal, G 2 1/4B / Rp 1 1/2
	0361951 050	1 screw fitting in brass for male thread with flat seal, G 2 3/4B / Rp 2

Accessories for AKM 105, AKM 115 (S) actuators

Type	Description
0372462 001	CASE Drives, PC tool for configuring the actuators on a computer
0510240 011	Temperature adapter, media temperature <5 °C
0510420 001	Adapter required when media temperature >100 °C
0510480 001	Auxiliary change-over contacts, single
0510480 002	Auxiliary change-over contacts, double

High-performance types and flexible combinations for all requirements: **Threaded and flanged valves** from SAUTER.

The complete product range of regulating valves.

The wide product range at SAUTER comprises threaded valves made of DZR cast brass and flanged valves in grey cast iron, ductile cast iron or cast steel. In combination with actuators with 2- or 3-point actuation or with the innovative SAUTER Universal Technology (SUT), they create exceptionally compact control units.

Installation and commissioning are no problem for you as the two components are very easy to fit and adapt automatically to the stroke of the valve. All nominal diameters up to DN 50 are equipped with a high quality seal in the plug. The nominal diameters starting from DN 65 are distinguished by a very precise sealing surface of metal or stainless steel. This enables even the most stringent requirements for regulating, cutting off and safety functions to be met.

Versatile operation and flexible handling.

SAUTER valves can mostly be used as control or distribution valves with or against the pressure. They are also reliable in the long term when there are high differential pressures. And they remain flexible when you make the required settings on your SUT actuator: As well as selecting the characteristic, you can adjust the running time and specify the input signal. Therefore, SAUTER offers you a complete range of valve actuators with pushing forces in the range from 250 N to 2500 N and suitable valves for every application.



VUN/BUN male thread valves in cast brass with electric linear actuators



Model series		AVM				AVM			AVM			AVF			
Type		105				115			321			124		125	
Version		F100	F120	F122	SF132	F120	F122	SF132	F110	F112	SF132	F130	F230	SF132	SF232
Voltage	230 V AC	•	•			•			•			•	•		
	24 V AC			•	•		•	•		•	•			•	•
	24 V DC				•					•	•				
Positioning signal	2-point	•	•	•	•	•	•	•	•	•	•			•	•
	3-point	•	•	•	•	•	•	•	•	•	•	•	•	•	•
	0...10 V				•						•				•
Feedback	4...20 mA										•			•	•
	0...10 V						•			•				•	•
Running time [s]		30	120	120	35 60 120	120	120	60 120	96 48	96 48	48	60 120	60 120	60 120	60 120
Return time [s]												18		18	
Pushing force [N]			250				500			1000			500		
Characteristic	equal-percentage	•	•	•	•	•	•	•	•	•	•	•	•	•	•
Combination	linear				•			•		•				•	•
	quadratic						•			•				•	•
Spring return	without power, closes the ball valve											•		•	
	without power, opens the ball valve												•		•

¹⁾ Requires accessory 0500570 003

Male thread valves in cast brass, PN16, equal percentage (F3**) and linear (F2**) characteristic

Type		DN	Connection	Kvs (m³/h)	Stroke (mm)	ΔP _{max} [bar]				
2-way -15 °C...150 °C	VUN 015 F350	15	G 1B	0.4	8	4	6	10	6	
	VUN 015 F340	15	G 1B	0.63	8	4	6	10	6	
	VUN 015 F330	15	G 1B	1	8	4	6	10	6	
	VUN 015 F320	15	G 1B	1.6	8	4	6	10	6	
	VUN 015 F310	15	G 1B	2.5	8	4	6	10	6	
	VUN 015 F300	15	G 1B	4	8	4	6	10	6	
	VUN 020 F300	20	G 1¼B	6.3	8	4	5	10	5	
	VUN 025 F300	25	G 1½B	10	8	4	4	10	4	
	VUN 032 F300	32	G 2B	16	8	3	3.5	10	3.5	
	VUN 040 F300	40	G 2¼B	22	8	3	3	6	3	
	VUN 050 F300	50	G 2¾B	28	8	1	2.4	4	3	
	VUN 050 F200	50	G 2¾B	40	8	1	2.4	4	2.4	
	3-way -15 °C...150 °C	BUN 015 F330	15	G 1B	1	8	4	6	10	6
		BUN 015 F320	15	G 1B	1.6	8	4	6	10	6
BUN 015 F310		15	G 1B	2.5	8	4	6	10	6	
BUN 015 F300		15	G 1B	4	8	4	6	10	6	
BUN 020 F300		20	G 1¼B	6.3	8	4	5	10	5	
BUN 025 F300		25	G 1½B	10	8	3	4	10	4	
BUN 032 F300		35	G 2B	16	8	2	3.7	10	3.7	
BUN 040 F300		40	G 2¼B	22	8	1.2	2.7	6	2.7	
BUN 050 F300		50	G 2¾B	28	8	0.8	1.8	4	1.8	
BUN 050 F200		50	G 2¾B	40	8	0.8	1.8	4	1.8	

Area of use for SAUTER control valves in combination with electric actuators

		Cast brass PN16		Cast brass PN40	Grey cast iron PN6				Grey cast iron PN10/16				
Valve/ball valve model series		VUN BUN DN15...50		VKR/VKRA BKR/BKRA DN15...50	VUD BUD DN15...50		VQD BQD DN65...100		VUE BUE DN15...50		VQE BQE DN65...150		DN15...
Valve actuator model series		AVM 105	AVM 321	AKM 105	AVM 105	AVM 321	AVM 322	AVM 234	AVM 105	AVM 321	AVM 322	AVM 234	AVM 105
		AVM 115		AKM 115	AVM 115			AVF 234	AVM 115			AVF 234	AVM 115
		AVF 124		AKF 112	AVF 124				AVF 124				AVF 124
		AVF 125		AKF 113	AVF 125				AVM 125				AVM 125
Medium	Temp. range												
Water with anti-freeze (glycol 20...55%), brine solution	-30...-21 °C												
	-20...-16 °C												
	-15...-11 °C	H1 K1/K2	H1 K1/K2										S K1/ S K1/ S K1/ S
	-10...-2 °C	K1/K2	K1/K2	H10	K1/K2	K1/K2	K1/K2	K1/K2	K1/K2	K1/K2	K1/K2	K1/K2	S K1/ S
Cold water	3...20 °C	•	•	•	•	•	•	•	•	•	•	•	S
Hot water	21...100 °C	•	•	•	•	•	•	•	•	•	•	•	•
	101...130 °C	H1	H1	H11	H1	H1	H5	•	H1	H1	H5	•	•
Hot water	131...150 °C	H2	H2		H2	H2	H5	H3	H2	H2	H5	H3	H3
	151...180 °C												H3
	181...200 °C												
	201...210 °C												
	211...220 °C												
221...230 °C													
Water vapour	100...115 °C								H1 ²	H1 ²	• ²	• ²	•
	116...130 °C												•
	131...180 °C												H3
	181...200 °C												
	201...220 °C												
221...240 °C													

¹ PTFE stuffing box with grease containing silicone can only be used up to DN 125

² 2-way valves only

• Standard model

Accessories	Type	Description
K1	0378284 100	Stuffing box heater 230 V AC, 15 W, for media below 0 °C
K2	0378284 102	Stuffing box heater 24 V AC, 15 W, for media below 0 °C
H1	0372249 001	Adapter required when media temperature >100 °C up to max. 130 °C (AVM 1**, AVM 321)
H2	0372249 002	Adapter required when media temperature >130 °C up to max. 150 °C (AVM 1**, AVM 321)
H3	0372336 180	Extension for media temperature up to 180° (AV* 234, AVN 224)
H4	0372336 240	Extension for media temperature up to 240° (AV* 234, AVN 224)
H5	0500240 001	Extension for media temperature up to 180° (AVM 322)
H6	0500240 002	Extension for media temperature up to 240° (AVM 322)
H10	0510240 011	Adapter required when media temperature <3 °C
H11	0510420 001	Adapter required when media temperature >100 °C

ators

Ductile cast iron PN16				Ductile cast iron PN25						Cast steel PN40					
VUG		BUG		VUG		BUG		VUP		VUS			BUS		
DN15...50	DN65...80	DN15...50	DN65...80	DN15...50	DN65...150	DN15...50	DN65...150	DN40	DN50...150	DN15...50	DN65...100	DN125...150	DN15...50	DN65...100	DN125...150
AVM 234	AVM 322	AVM 234	AVM 322	AVM 234	AVM 322	AVM 234	AVM 322	AVM 234	AVM 322	AVM 322	AVM 234	AVM 322	AVM 322	AVM 234	AVM 322
AVF 234		AVF 234		AVF 234		AVF 234		AVF 234			AVF 234			AVF 234	
AVN 224		AVN 224		AVN 224		AVN 224		AVN 224							
S ¹	S ¹	S ¹	S ¹	S ¹	S ¹	S ¹	S ¹	K1/K2	K1/K2	FB	FB	FB	FB	FB	FB
K1/K2	K1/K2	K1/K2	K1/K2	K1/K2	K1/K2	K1/K2	K1/K2	K1/K2	K1/K2	FB	FB	FB	FB	FB	FB
S ¹	S ¹	S ¹	S ¹	S ¹	S ¹	S ¹	S ¹	K1/K2	K1/K2	FB	FB	FB	FB	FB	FB
K1/K2	K1/K2	K1/K2	K1/K2	K1/K2	K1/K2	K1/K2	K1/K2	K1/K2	K1/K2	•	•	•	•	•	•
S ¹	S ¹	S ¹	S ¹	S ¹	S ¹	S ¹	S ¹	•	•	•	•	•	•	•	•
•	•	•	•	•	•	•	•	•	•	•	•	•	•	•	•
•	•	•	•	•	•	•	•	•	•	•	•	•	•	•	•
H3	H5	H3	H5	H3	H5	H3	H5	H3	H5	H5	H3	H3	H5	H3	H3
H3	H5	H3	H5	H3	H5	H3	H5	H3	H5	H5	H3	H3	H5	H3	H3
				H6	H4	H6	H4	H6	H4	H6	H4	H4	H6	H4	H4
										H6	H4	H4	H6	H4	H4
										H6	H4	H4	H6	H4	H4
										H6/G1	H4/G2	H4/G3	H6/G1	H4/G2	H4/G3
•				•	•			•	•	•	•	•	•		
•				•	•			•	•	•	•	•	•		
H3				H5	H3			H5	H3	H5	H3	H3			
				H6	H4			H6	H4	H6	H4	H4			
										H6	H4	H4			
										H6/G1	H4/G2	H4/G3			

Stuffing box variants	Type	Description
G1	0378373 001	Stuffing box with graphite seal for temperatures of 220...260 °C, DN 15...50
G2	0378373 002	Stuffing box with graphite seal for temperatures of 220...260 °C, DN 65...100
G3	0378373 003	Stuffing box with graphite seal for temperatures of 220...260 °C, DN 125...150
S	0560260 001	PTFE stuffing box with grease containing silicone
FB		with bellows on request

VUD/VQD/BUD/BQD flanged valves in grey cast iron with electric linear actuators

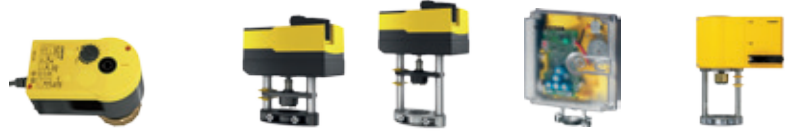

Model series		AVM				AVM				AVM				AVF				AVM		AVF					
Type		105				115				321				322				124		125		234		234	
Version		F100	F120	F122	SF132	F120	F122	SF132	F110	F112	SF132	F120	F122	SF132	F130	F230	SF132	SF232	SF132	SF132	SF232				
Voltage	230 V AC	•	•			•			•		• ²⁾	•		• ²⁾	•	•			• ¹⁾	• ¹⁾	• ¹⁾				
	24 V AC			•	•		•	•		•	•		•	•			•	•							
	24 V DC				•			•		•	•		•	•											
Positioning signal	2-point	•	•	•	•	•	•	•	•	•	•	•	•	•			•	•	•	•	•				
	3-point	•	•	•	•	•	•	•	•	•	•	•	•	•											
	0...10 V			•				•			•			•			•	•			•				
	4...20 mA										•			•			•	•			•				
Feedback	0...10 V							•			•			•			•	•			•				
Running time [s]		30	120	120	60 120	120	120	60 120	96 48	96 48	48 32	120 240	120 240	80 120	60 120	60 120	60 120	60 120	40/80 80/160 120/240	40/80 80/160 120/240					
Return time [s]															18	18									
Pushing force [N]						250		500			1000			1000			500			2500	2000				
Characteristic	equal-percentage	•	•	•	•	•	•	•	•	•	•	•	•	•	•	•	•	•	•	•	•				
	linear				•			•			•			•			•	•			•				
	quadratic							•									•	•			•				
Spring return	without power, closes the valve														•		•				•				
	without power, opens the valve															•		•			•				

¹⁾ Requires accessory 0372332 001

²⁾ Requires accessory 0500570 003

Flanged valves in grey cast iron, PN6, equal percentage (F3**) and linear (F2**) characteristic

Type	DN	Kvs (m³/h)	Stroke (mm)	ΔP _{max} [bar]							
2-way -10 °C...150 °C	VUD 015 F320	15	1.6	8	4	6	6	6	6		
	VUD 015 F310	15	2.5	8	4	6	6	6	6		
	VUD 015 F300	15	4	8	4	6	6	6	6		
	VUD 020 F300	20	6.3	8	4	6	6	6	6		
	VUD 025 F300	25	10	8	2.8	6	6	6	6		
	VUD 032 F300	32	16	8	2.1	5.2	6	6	5.2		
	VUD 040 F300	40	22	8	1.2	3.3	6	6	3.3		
	VUD 050 F200	50	40	8	0.9	2	4	4	2		
	VUD 050 F300	50	28	8	0.9	2	4	4	2		
	VQD 065 F300	65	63	20				2.5		3	3
	VQD 080 F300	80	100	20				1.5		3	3
	VQD 100 F300	100	160	40						2	2
	3-way -10 °C...150 °C	BUD 015 F320	15	1.6	8	4	6	6	6	6	
BUD 015 F310		15	2.5	8	4	6	6	6	6		
BUD 015 F300		15	4	8	4	6	6	6	6		
BUD 020 F300		20	6.3	8	4	6	6	6	6		
BUD 025 F300		25	10	8	2.8	6	6	6	6		
BUD 032 F300		32	16	8	2.1	5.2	6	6	5.2		
BUD 040 F300		40	22	8	1.2	3.3	6	6	3.3		
BUD 050 F200		50	40	8	0.9	2	4	4	2		
BUD 050 F300		50	28	8	0.9	2	4	4	2		
BQD 065 F300		65	63	20				2.5		3	3
BQD 080 F300		80	100	20				1.5		3	3
BQD 100 F300		100	160	40						2	2

VUE/VQE/BUE/BQE flanged valves in grey cast iron with electric linear actuators

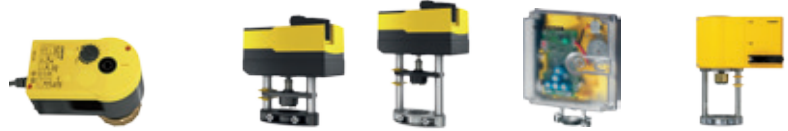

Model series		AVM				AVM				AVM				AVF				AVM		AVF					
Type		105				115				321				322				124		125		234		234	
Version		F100	F120	F122	SF132	F120	F122	SF132	F110	F112	SF132	F120	F122	SF132	F130	F230	SF132	SF232	SF132	SF132	SF232				
Voltage	230 V AC	●	●			●			●		● ²⁾	●		● ²⁾	●	●			● ¹⁾	● ¹⁾	● ¹⁾				
	24 V AC			●	●		●	●		●	●		●	●		●	●			●	●	●			
	24 V DC				●			●		●	●		●	●			●	●			●	●			
Positioning signal	2-point	●	●	●	●	●	●	●	●	●	●	●	●	●	●	●	●	●	●	●	●	●			
	3-point	●	●	●	●	●	●	●	●	●	●	●	●	●	●	●	●	●	●	●	●	●			
	0...10 V				●			●			●			●			●	●		●	●	●			
Feedback	4...20 mA									●			●			●	●		●	●	●				
	0...10 V							●		●			●			●	●		●	●	●				
Running time [s]		30	120	120	60	120	120	60	96	96	48	120	120	80	60	60	60	60	40/80	40/80	40/80				
Return time [s]					35			120	48	48	32	240	240	120	120	120	120	120	80/160	80/160	80/160				
Pushing force [N]			250				500			1000			1000			500			2500	2000					
Combination	equal:percentage	●	●	●	●	●	●	●	●	●	●	●	●	●	●	●	●	●	●	●	●				
	linear				●			●			●			●			●		●	●	●				
	quadratic							●									●		●	●	●				
Spring return	without power, closes the valve														●		●			●	●				
	without power, opens the valve															●					●				

¹⁾ Requires accessory 0372332 001

²⁾ Requires accessory 0500570 003

Flanged valves in grey cast iron, PN16/10, equal percentage (F3**) and linear (F2**) characteristic

Type		DN	Kvs (m³/h)	Stroke (mm)	Δp _{max} [bar]								
2-way -10 °C...150 °C	VUE 015 F350	15	0.4	8	4	6	10			6			
	VUE 015 F340	15	0.63	8	4	6	10			6			
	VUE 015 F330	15	1	8	4	6	10			6			
	VUE 015 F320	15	1.6	8	4	6	10			6			
	VUE 015 F310	15	2.5	8	4	6	10			6			
	VUE 015 F300	15	4	8	4	6	10			6			
	VUE 020 F300	20	6.3	8	4	6	10			6			
	VUE 025 F300	25	10	8	2.8	6	10			6			
	VUE 032 F300	32	16	8	2.1	5.2	10			5.2			
	VUE 040 F300	40	22	8	1.4	3.3	6			3.3			
	VUE 050 F200	50	40	8	0.9	2	4			2			
	VUE 050 F300	50	28	8	0.9	2	4			2			
	VQE 065 F300	65	63	20				2.5			3	3	
	VQE 080 F300	80	100	20				1.5			3	3	
	VQE 100 F300	100	160	40							2	2	
	VQE 125 F300	125	220	40							1.5	1.4	
VQE 150 F300	150	320	40							1	1		
3-way -10 °C...150 °C	BUE 015 F330	15	1	8	4	6	10			6			
	BUE 015 F320	15	1.6	8	4	6	10			6			
	BUE 015 F310	15	2.5	8	4	6	10			6			
	BUE 015 F300	15	4	8	4	6	10			6			
	BUE 020 F300	20	6.3	8	4	6	10			6			
	BUE 025 F300	25	10	8	2.8	6	10			6			
	BUE 032 F300	32	16	8	2.1	5.2	10			5.2			
	BUE 040 F300	40	22	8	1.4	3.3	6			3.3			
	BUE 050 F200	50	40	8	0.9	2	4			2			
	BUE 050 F300	50	28	8	0.9	2	4			2			
	BQE 065 F300	65	63	20				2.5			3	3	
	BQE 080 F300	80	100	20				1.5			3	3	
	BQE 100 F300	100	160	40							2	2	
	BQE 125 F300	125	220	40							1.5	1.4	
	BQE 150 F300	150	320	40							1	1	

VUG/BUG flanged valves in ductile cast iron with electric linear actuators



Model series		AVM			AVM	AVF		AVN	
Type		322			234	234		224	
Version		F120	F122	SF132	SF132	SF132	SF232	SF132	SF232
Voltage		230 V AC		● ²⁾	● ¹⁾	● ¹⁾	● ¹⁾	● ¹⁾	● ¹⁾
		24 V AC	●		●	●	●	●	●
		24 V DC	●	●		●	●	●	●
Positioning signal		2-point	●	●	●	●	●	●	●
		3-point	●	●	●	●	●	●	●
		0...10 V		●	●	●	●	●	●
		4...20 mA		●	●	●	●	●	●
Feedback		0...10 V		●	●	●	●	●	●
Running time [s]		120	120	80	40/80 80/160	40/80 80/160	40/80 80/160	40/80 80/160	40/80 80/160
Return time [s]		240	240	120	120/240	120/240	15...30	15...30	15...30
Pushing force [N]		1000			2500	2000		1100	
Characteristic		equal:percentage			●	●	●	●	●
Combination		linear			●	●	●	●	●
		quadratic			●	●	●	●	●
Spring return		without power, closes the ball valve				●		●	
		without power, opens the ball valve					●		●

¹⁾ Requires accessory 0372332 001

²⁾ Requires accessory 0500570 003

Flanged valves in ductile cast iron, PN25/16, equal percentage (F3**) characteristic

	Type	DN	Flange	Kvs (m³/h)	Stroke (mm)	Δp _{max} [bar]			
2-way -20 °C...200 °C	VUG 015 F374	15	PN25/16	0.16	20	16	16	16	16
	VUG 015 F364	15	PN25/16	0.25	20	16	16	16	16
	VUG 015 F354	15	PN25/16	0.4	20	16	16	16	16
	VUG 015 F344	15	PN25/16	0.63	20	16	16	16	16
	VUG 015 F334	15	PN25/16	1	20	16	16	16	16
	VUG 015 F324	15	PN25/16	1.6	20	16	16	16	16
	VUG 015 F314	15	PN25/16	2.5	20	16	16	16	16
	VUG 015 F304	15	PN25/16	4	20	16	16	16	16
	VUG 020 F304	20	PN25/16	6.3	20	16	16	16	16
	VUG 025 F304	25	PN25/16	10	20	15.2	16	16	16
	VUG 032 F304	32	PN25/16	16	20	9.4	16	16	10.5
	VUG 040 F304	40	PN25/16	25	20	6.1	16	13.5	6.5
	VUG 050 F304	50	PN25/16	40	20	4	11	8.5	4
	VUG 065 F316	65	PN16	63	40		7.1	5.6	3
	VUG 065 F304	65	PN25	63	40		7.1	5.6	3
	VUG 080 F304	80	PN25/16	100	40		4.7	3.4	2
	VUG 100 F304	100	PN25	160	40		3	2.2	1.1
VUG 125 F304	125	PN25	250	40		2	1.6	0.8	
VUG 150 F304	150	PN25	340	40		1.5	1.2	0.6	
3-way -20 °C...200 °C	BUG 015 F334	15	PN25/16	1	20	16	16	16	16
	BUG 015 F324	15	PN25/16	1.6	20	16	16	16	16
	BUG 015 F314	15	PN25/16	2.5	20	16	16	16	16
	BUG 015 F304	15	PN25/16	4	20	16	16	16	16
	BUG 020 F304	20	PN25/16	6.3	20	16	16	16	16
	BUG 025 F304	25	PN25/16	10	20	15.2	16	16	16
	BUG 032 F304	32	PN25/16	16	20	9.4	16	16	10.5
	BUG 040 F304	40	PN25/16	25	20	6.1	16	13.5	6.5
	BUG 050 F304	50	PN25/16	40	20	4	11	8.5	4
	BUG 065 F316	65	PN16	63	40		7.1	5.6	3
	BUG 065 F304	65	PN25	63	40		7.1	5.6	3
	BUG 080 F304	80	PN25/16	100	40		4.7	3.4	2
	BUG 100 F304	100	PN25	160	40		3	2.2	1.1
	BUG 125 F304	125	PN25	250	40		2	1.6	0.8
	BUG 150 F304	150	PN25	340	40		1.5	1.2	0.6

VUP flanged valves, pressure-compensated, in ductile cast iron with electric linear actuators



Model series		AVM			AVM		AVF		AVN	
Type		322			234		234		224	
Version		F120	F122	SF132	SF132	SF132	SF232	SF132	SF232	
Voltage	230 V AC	•		• ²⁾	• ¹⁾	• ¹⁾	• ¹⁾	• ¹⁾	• ¹⁾	• ¹⁾
	24 V AC		•	•	•	•	•	•	•	•
	24 V DC		•	•						
Positioning signal	2-point	•	•	•	•	•	•	•	•	•
	3-point	•	•	•	•	•	•	•	•	•
	0...10 V			•	•	•	•	•	•	•
	4...20 mA			•	•	•	•	•	•	•
Feedback	0...10 V			•	•	•	•	•	•	•
Running time [s]		120	120	80	40/80	40/80	40/80	40/80	40/80	
		240	240	120	80/160 120/240	80/160 120/240	80/160 120/240	80/160 120/240	80/160 120/240	
Return time [s]						15...30		15...30		
Pushing force [N]			1000		2500	2000		1100		
Characteristic	equal-percentage	•	•	•	•	•	•	•	•	•
Combination	linear			•	•	•	•	•	•	•
	quadratic				•	•	•	•	•	•
Spring return	without power, closes the ball valve						•			•
	without power, opens the ball valve							•		•

¹⁾ Requires accessory 0372332 001

²⁾ Requires accessory 0500570 003

Flanged valves in ductile cast iron, PN25, pressure-compensated, equal percentage (F3**) characteristic

		Type	DN	Flange	Kvs (m³/h)	Stroke (mm)	Δp _{max} [bar]		
2-way -20 °C...200 °C 	VUP 040 F304	40	PN25	25	14	25	25	25	25
	VUP 050 F304	50	PN25	40	25		25	25	20
	VUP 065 F304	65	PN25	63	25		25	25	16
	VUP 080 F304	80	PN25	100	25		25	25	12
	VUP 100 F304	100	PN25	160	40		25	20	9
	VUP 125 F304	125	PN25	250	40		19	14	6
	VUP 150 F304	150	PN25	350	40		15	10	4

VUS/BUS flanged valves in cast steel with electric linear actuators



Model series		AVM			AVM	AVF		AVN	
Type		322			234	234		224	
Version		F120	F122	SF132	SF132	SF132	SF232	SF132	SF232
Voltage	230 V AC	●		● ²⁾	● ¹⁾	● ¹⁾	● ¹⁾	● ¹⁾	● ¹⁾
	24 V AC		●	●	●	●	●	●	●
	24 V DC		●	●		●	●	●	●
Positioning signal	2-point	●	●	●	●	●	●	●	●
	3-point	●	●	●	●	●	●	●	●
	0...10 V			●	●	●	●	●	●
Feedback	4...20 mA			●	●	●	●	●	●
	0...10 V			●	●	●	●	●	●
Running time [s]		120	120	80	40/80	40/80	40/80	40/80	
		240	240	120	80/160 120/240	80/160 120/240	80/160 120/240	80/160 120/240	
Return time [s]						15...30		15...30	
Pushing force [N]		1000			2500	2000		1100	
Characteristic		equal-percentage			●	●	●	●	●
Combination		linear			●			●	●
		quadratic				●	●	●	●
Spring return		without power, closes VUS valve/opens BUS valve					●		●
		without power, opens VUS valve/closes BUS valve					●	●	

¹⁾ Requires accessory 0372332 001

²⁾ Requires accessory 0500570 003

Flanged valves in cast steel, PN40, equal percentage (F3**) and linear (F2**) characteristic

	Type	DN	Flange	Kvs (m³/h)	Stroke (mm)		ΔP _{max} [bar]		
2-way -10 °C...260 °C	VUS 015 F375	15	PN40	0.16	20	24	40	40	24.5
	VUS 015 F365	15	PN40	0.25	20	24	40	40	24.5
	VUS 015 F355	15	PN40	0.4	20	24	40	40	24.5
	VUS 015 F345	15	PN40	0.63	20	24	40	40	24.5
	VUS 015 F335	15	PN40	1	20	24	40	40	24.5
	VUS 015 F325	15	PN40	1.6	20	24	40	40	24.5
	VUS 015 F315	15	PN40	2.5	20	24	40	40	24.5
	VUS 015 F305	15	PN40	4	20	24	40	40	24.5
	VUS 020 F305	20	PN40	6.3	20	15.3	40	40	17.5
	VUS 025 F305	25	PN40	10	20	12.8	37.8	29.6	14.7
	VUS 032 F305	32	PN40	16	20	9	28.7	22.5	11.1
	VUS 040 F305	40	PN40	25	20	5.4	16.4	12.8	6.2
	VUS 050 F305	50	PN40	40	20	3.3	10.5	8.2	3.9
	VUS 065 F305	65	PN40	63	30		6.1	4.7	2.1
	VUS 080 F305	80	PN40	100	30		3.9	3	1.3
	VUS 100 F305	100	PN40	160	30		1.5	1.5	0.8
	VUS 125 F305	125	PN40	220	40		1	1	0.4
VUS 150 F305	150	PN40	320	40		0.7	0.7	0.2	
3-way -10 °C...260 °C	BUS 015 F225	15	PN40	1.6	20	24	40	40	24.5
	BUS 015 F215	15	PN40	2.5	20	24	40	40	24.5
	BUS 015 F205	15	PN40	4	20	24	40	40	24.5
	BUS 020 F205	20	PN40	6.3	20	15.3	40	34.7	17.5
	BUS 025 F205	25	PN40	10	20	12.8	37.8	29.6	14.7
	BUS 032 F205	32	PN40	16	20	9	27	21.1	10.4
	BUS 040 F205	40	PN40	25	20	5.4	16.4	12.8	6.2
	BUS 050 F205	50	PN40	40	20	3.3	10.5	8.2	3.9
	BUS 065 F205	65	PN40	63	30		6.1	4.7	2.1
	BUS 080 F205	80	PN40	100	30		3.9	3	1.3
	BUS 100 F205	100	PN40	160	30		2.5	1.9	0.8
	BUS 125 F305	125	PN40	220	40		1.7	1.3	0.5
BUS 150 F305	150	PN40	320	40		1.2	0.9	0.3	

Important accessories for male thread and flanged valves

Strainer in gunmetal, PN16, -10...150 °C

Type	DN	Description
	0560332 015	15 ISO 228/1 - G 1/2, mesh aperture 0.5 mm
	0560332 020	20 ISO 228/1 - G 3/4, mesh aperture 0.8 mm
	0560332 025	25 ISO 228/1 - G 1, mesh aperture 0.8 mm
	0560332 032	32 ISO 228/1 - G 1 1/4, mesh aperture 0.8 mm
	0560332 040	40 ISO 228/1 - G 1 1/2, mesh aperture 0.8 mm
	0560332 050	50 ISO 228/1 - G 2, mesh aperture 0.8 mm

Accessories for valves with 8 mm stroke

Type	DN	Description
	0361951 015	1 screw fitting in brass for male thread with flat seal, G 1B / Rp 1/2
	0361951 020	1 screw fitting in brass for male thread with flat seal, G 1 1/4B / Rp 3/4
	0361951 025	1 screw fitting in brass for male thread with flat seal, G 1 1/2B / Rp 1
	0361951 032	1 screw fitting in brass for male thread with flat seal, G 2B / Rp 1 1/4
	0361951 040	1 screw fitting in brass for male thread with flat seal, G 2 1/4B / Rp 1 1/2
	0361951 050	1 screw fitting in brass for male thread with flat seal, G 2 3/4B / Rp 2

Type	Description	
	0372249 001	Temperature adapter >100 °C to 130 °C for valves with 8 mm stroke (for AVM 1**, AVM 321)
	0372249 002	Temperature adapter >130 °C to 150 °C for valves with 8 mm stroke (for AVM 1**, AVM 321)
	0378284 100	Stuffing box heater 230 V, 15 W for media below 0 °C
	0378284 102	Stuffing box heater 24 V, 15 W for media below 0 °C
	0372240 001	Manual adjustment for valves with 8 mm stroke

Accessories for valves starting from 20 mm stroke

Type	Description
0372336 180	Adapter required for media >130 °C, for valves with 20 or 40 mm stroke (for AV* 234, AVN 224)
0372336 240	Adapter required for media >180 °C, for valves with 20 or 40 mm stroke (for AV* 234, AVN 224)
0378284 100	Stuffing box heater 230 V, 15 W for media below 0 °C, suitable for all valves
0378284 102	Stuffing box heater 24 V, 15 W for media below 0 °C, suitable for all valves
0500240001	Extension for media temperature up to 180° (AVM 321)
0500240002	Extension for media temperature up to 240° (AVM 321)

Accessories for AVM 234S, AVF 234S and AVN 224S actuators

Type	Description
0313529 001	Split-range unit for adjusting sequences, suitable for all actuators
0372332 001	Module pluggable for 230 V supply voltage continuous, 2- or 3-point (for AV* 234, AVN 224)
0372332 002	Module pluggable for 100 V supply voltage continuous, 2- or 3-point (for AV* 234, AVN 224)
0372333 001	2 auxiliary change-over contacts, infinitely variable, load 6 (2)A (for AV* 234, AVN 224)
0372462 001	CASE Drives, PC tool for configuring the actuators on a computer

Accessories for AVM 105, AVM 115 actuators

Type	Description
0372145 001	Auxiliary change-over contacts, single
0372145 002	Auxiliary change-over contacts, double
0372320 001	Hexagon key for manual adjustment

Accessories for AVF 124, AVF 125S actuators

Type	Description
0370880 001	Mechanical stroke indicator
0370881 001	Auxiliary change-over contacts, single, infinitely variable

Accessories for AVM 321, AVM 322 actuators

Type	Description
0500420 001	Split-range unit module
0500420 002	4...20 mA feedback module
0500570 003	Continuous 230 V module
0510220 001	CASE Drives configuration tool

Reliable in every medium: tightly sealing **butterfly valves** from SAUTER.

Can be used universally, energy-efficient.

SAUTER butterfly valves are very versatile and are used for control or shut-off functions. Because they close absolutely tightly, they reduce energy consumption. Heaters and coolers are connected to boilers and cooling systems as required. If this is not required or a changeover has to be performed, the SAUTER butterfly valve separates the circuits completely and reliably.

Good equipment for flexibility and tightness.

Butterfly valves can be combined perfectly with SAUTER rotary actuators. They are so smooth-running that even actuators with only 1.5 or 30 Nm can be used. The hole pattern of the butterfly valve is designed to suit PN6, PN10 or PN16 flanges. An EPDM collar ensures the tightness of the valve so that different media, such as water, air, brine, water with additives etc., can be used.



DEF butterfly valves in grey cast iron with ASM, ASF, ADM or A44 rotary actuators



Model series		ASM			ASF			ADM			A44			ASF		ASF			
Type		124			134			322			W2			122		123			
Version		F120	F122	SF132	F130	SF132	F120	F122	HF120	HF122	SF122	SF152	F001	F020	SF001	F120	F122	F122	SF122
Voltage	230 V AC	•			•		•		•				•			•			
	24 V AC		•	•		•		•	•	•	•			•	•		•	•	•
	24 V DC			•		•		•	•	•	•				•		•	•	•
Positioning signal	2-point	•	•	•	•	•	•	•	•	•	•					•	•		
	3-point	•	•	•	•	•	•	•	•	•	•		•	•				•	
	0...10 V			•		•									•				•
	2...10 V																		
	0...20 mA																		
Feedback	4...20 mA																		
	0...10 V			•		•									•				•
Running time [s]		120	120	120	120	120	120	120	120	120	30		90	120	120	90	90	90	90
							240	240	240	240	120	60	120	120	120				
Torque [Nm]		18	18	15	30				15					30				18	
Rotation angle		90° fixed			90° fixed			≥90°			≥90°			90° fixed					
Double contacts integrated									•	•									

Tight-sealing butterfly valve PN16, flange PN6/10/16

	Type	DN	Δp_{max} (bar)										
			25	32	40	50	65	80	100	125	150	200	
-10...130 °C	DEF 025 F200	25	10					10		16			10
	DEF 032 F200	32	10					10		16			10
	DEF 040 F200	40	10					10		16			10
	DEF 050 F200	50	10					10		16			10
	DEF 065 F200	65	7	7				7		16			7
	DEF 080 F200	80	4	7				4		10			4
	DEF 100 F200	100	2	7				2		10			2
	DEF 125 F200	125		7						6			
	DEF 150 F200	150		6						5			
	DEF 200 F200	200		2						3			



Important accessories for butterfly valves and actuators

Type	Description
0378110 001	Assembly part DEF DN 25-65 for A44
0378111 001	Assembly part DEF DN 80-125 for A44
0378112 001	Assembly part DEF DN 150-200 for A44
0378113 001	Assembly part DEF DN 25-100 for ASF
0372455 001	Assembly parts DEF DN 25...65 for ASM 124/134
0372455 002	Assembly parts DEF DN 80...100 for ASM 124/134
0372455 002	Assembly parts DEF DN 125 for ASM 134
0372455 003	Assembly parts DEF DN 150...200 for ASM 134
0370990 002	Auxiliary change-over contacts, double, for ASM 124/134
0370493 000	Auxiliary change-over contacts, double, for A44
0370640 001	Potentiometer 2000 Ω for A44
0510240 014	ADM 322 fitting kit with DEF DN 20...65
0510240 014	ADM 322 fitting kit with DEF DN 80...100

For heating installations, single-family homes and community heating: **rotary actuators and control valves** from SAUTER.

Control valves: reliability for trouble-free heating functions.

SAUTER control valves are used to control heating and cooling systems in buildings. The 3-way version is suitable for controlling and change-over functions, while the 4-way version is employed for higher temperatures in the return circuit. You can get all variants threaded (in small nominal diameters, made of brass) or with a flange connection, made of ductile cast iron. To increase the regulating precision when setting the supply temperature and thus achieve a high degree of energy efficiency, we also recommend the weather-dependent SAUTER heating controller.

Ideally combined: control valves with rotary and damper actuators from SAUTER.

A complete family of actuators is available from SAUTER – with actuating power of 5 Nm to 18 Nm. All SAUTER actuators naturally have a manual adjuster.



Control valves in grey cast iron MH and cast brass M3R/M4R with ADM or ASM rotary actuators



Model series		ADM						ASM				ASM				ASM			
Type		322						105				115				124			
Version		F120	F122	HF120	HF122	SF122	SF152	F120	F122	SF132	SF152	F120	F122	SF132	SF152	F120	F122	SF132	
Voltage	230 V AC	•		•				•				•				•			
	24 V AC		•		•	•	•		•	•	•		•	•	•		•	•	
	24 V DC		•		•	•	•		•	•	•		•	•	•		•	•	
Positioning signal	2-point	•	•	•	•			•	•	•	•	•	•	•	•		•	•	
	3-point	•	•	•	•			•	•	•	•	•	•	•	•	•	•	•	
	0...10 V					•	•			•	•			•	•			•	
	2...10 V					•	•												
	0...20 mA					•	•												
Feedback	4...20 mA					•	•												
	0...10 V					•	•			•	•			•	•			•	
Running time [s]		120	120	120	120	120	30	120	120	35	60	3	120	120	60	6	120	120	120
		240	240	240	240		60			120	120				120				
Torque [Nm]					15					5				10				15/18	
Rotation angle					≥90°					90°				90°				90°	
Double contacts integrated				•	•														

Control valves in grey cast iron with flange connection PN6

		Type	DN	Kvs (m³/h)		Δp _{max} (bar)		
3-way valve 2 °C...110 °C		MH32 F20 F200	20	12	1	1	1	1
		MH32 F25 F200	25	18	1	1	1	1
		MH32 F32 F200	32	28	1	1	1	1
		MH32 F40 F200	40	44	1	1	1	1
		MH32 F50 F200	50	66	0.5		0.5	0.5
		MH32 F65 F200	65	100	0.5		0.5	0.5
		MH32 F80 F200	80	150	0.5		0.5	0.5
		MH32 F100 F200	100	225	0.5			0.5
		MH32 F125 F200	125	310	0.5			0.5
		MH32 F150 F200	150	420	0.5			0.5
4-way valve 2 °C...110 °C		MH42 F32 F200	32	28	1			1
		MH42 F40 F200	40	44	1			1
		MH42 F50 F200	50	66	0.5			0.5

Control valves in cast brass with female thread connection PN6

		Type	DN	Connection	Kvs (m³/h)		Δp _{max} (bar)		
3-way valve 2 °C...110 °C		M3R 015 F200	15	Rp ½	2.5	2	2	2	2
		M3R 020 F200	20	Rp ¾	6	2	2	2	2
		M3R 025 F200	25	Rp 1	12	1	1	1	1
		M3R 032 F200	32	Rp 1¼	18	1	1	1	1
		M3R 040 F200	40	Rp 1½	26	1	1	1	1
		M3R 050 F200	50	Rp 2	40	1	1	1	1
4-way valve 2 °C...110 °C		M4R 020 F200	20	Rp ¾	6	2	2	2	2
		M4R 025 F200	25	Rp 1	12	2	2	2	2
		M4R 032 F200	32	Rp 1¼	18	1	1	1	1
		M4R 040 F200	40	Rp 1½	26	1	1	1	1
		M4R 050 F200	50	Rp 2	40	1	1	1	1

Important accessories for control valves and actuators

Type	Description
0361977 001	Assembly part for ASM 124
0361977 002	Assembly part for ASM 105/115 with lever
0370990 002	Auxiliary change-over contacts, double, for ASM 124/134
0510240 013	ADM 322 fitting kit with M3R, M4R, MH32, MH42

Retrofit actuators for valve types from a range of third-party manufacturers

Replacement made **easy**.

Ideal for retrofitting projects.

SAUTER will make your HVAC installation fit for the future. Our modern, energy-efficient actuators can be fitted onto practically all existing valves. Thus they are also ideally suited for retrofitting projects. SAUTER valve actuators are powerful and economical. They can be used in many applications, fitted quickly and are immediately ready for operation.

The electric linear actuators.

The electric actuators from SAUTER stand for optimum operating convenience and high energy efficiency. In stand-by mode, in particular, the energy consumption of the actuators is minimal. The patented automatic valve coupling enables fast, uncomplicated fitting of the actuator onto the valve and easy, safe commissioning. The sturdy construction guarantees durability without any additional maintenance work. The high-quality mechanical transmission system ensures a high level of precision and low operation noise.

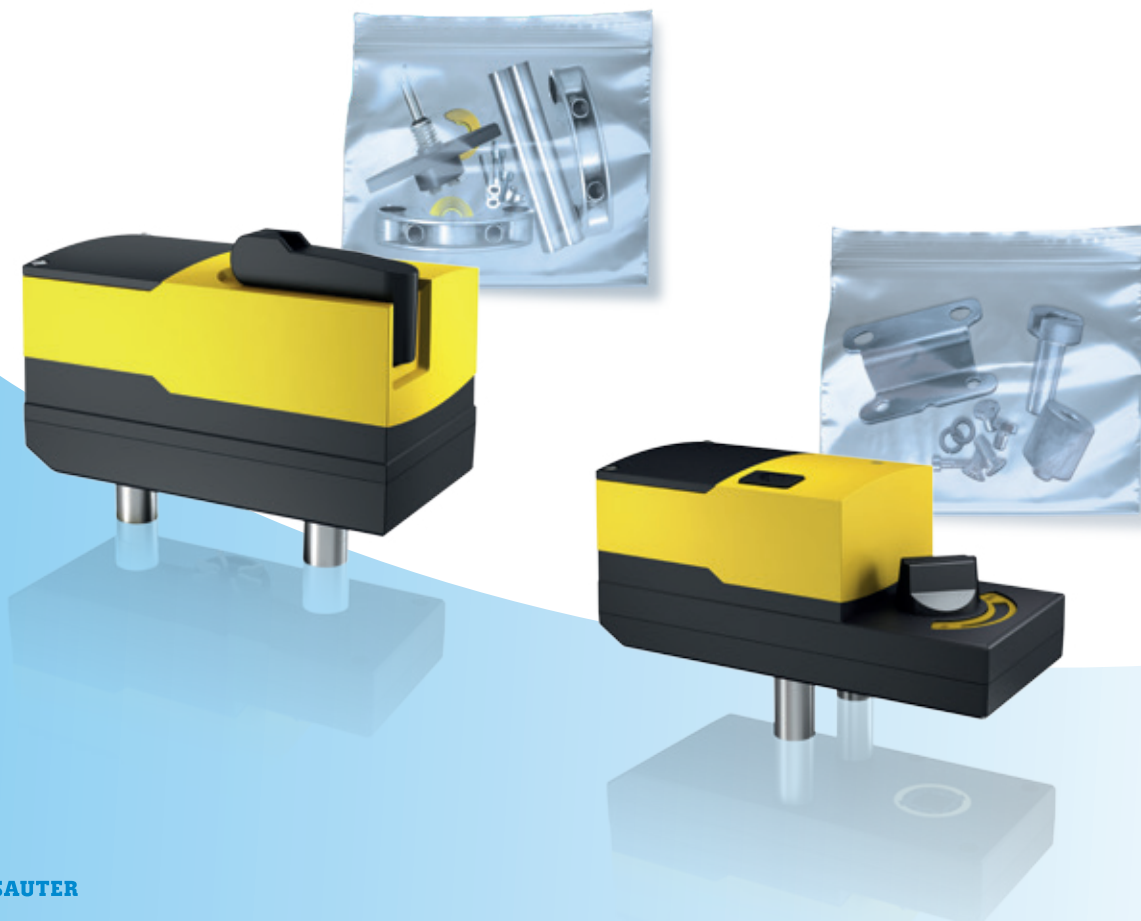

vialoq AVM 1000 electric linear actuator for non-SAUTER valves and retrofitting



Model series		AVM		
Type		322		
Version		F120R	F122R	SF132R
Voltage	230 V AC	•		• ¹⁾
	24 V AC		•	•
	24 V DC		•	•
Positioning signal	2-point	•	•	•
	3-point	•	•	•
	0...10 V			•
Feedback	4...20 mA			•
	0...10 V			•
Running time for the nominal stroke [s]		120	120	80
		240	240	120
Nominal stroke [mm]		20		
Pushing force [N]		1000		

¹⁾ Requires accessory 0500420 003

Manufacturer	Type	DN	Fitting kit
SAUTER	VUD/VQD	65-80	0510390 020
	BUD/BQD	65-80	0510390 020
	VUE/VQE	65-80	0510390 020
	BUE/BQE	65-80	0510390 020
	VUG	15-50	0510390 020
	BUG	15-50	0510390 020
	V6R	15-50	0510390 021
	B6R	15-50	0510390 021
	V6F/G/S	15-50	0510390 021
	B6F/G/S	15-50	0510390 021
Siemens	WF21	25-80	0510390 022
	VXF21	25-80	0510390 022
	WF31	15-80	0510390 022
	VXF31	15-80	0510390 022
	WF40	15-80	0510390 022
	VXF40	15-80	0510390 022
	WF41	50	0510390 022
	VXF41	15-50	0510390 022
	WF45	50	0510390 022
	WF52	15-40	0510390 022
	WF52G	15-40	0510390 022
	WF52J	15-40	0510390 022
	WF52GJ	15-40	0510390 022
	WF61	15-50	0510390 022
WG41	15-50	0510390 022	
VPF52E/F	15-40	0510390 022	
Belimo	H6...R	15-65	0510390 027
	H7...R	15-65	0510390 027
	H4...B	15-50	0510390 027
	H5...B	15-50	0510390 027
	H6...N	15-65	0510390 027
	H7...N	15-65	0510390 027
Frese	Optima compact	50-80	0510390 028

vialoq AVM 1000 electric linear actuator for non-SAUTER valves and retrofitting



Model series		AVM		
Type		322		
Version		F120R	F122R	SF132R
Voltage	230 V AC	●		● ¹⁾
	24 V AC		●	●
	24 V DC		●	●
Positioning signal	2-point	●	●	●
	3-point	●	●	●
	0...10 V			●
Feedback	4...20 mA			●
	0...10 V			●
Running time for the nominal stroke [s]		48	48	32
Nominal stroke [mm]		96	96	48
Pushing force [N]			1000	

¹⁾ Requires accessory 0500420 003

Manufacturer	Type	DN	Fitting kit
LDM	RV113 R	15-50	0510390 009
	RV113 M	15-50	0510390 009
Johnson Controls	VBD-4xx4	15-40	0510390 023
	VBD-4xx8	15-40	0510390 023
	VBF-2xx4	15-40	0510390 023
	VBF-2xx8	15-40	0510390 023
	VG82../VG84..	15-40	0510390 023
	VG88../VG89..	15-40	0510390 023
Honeywell	V5016A	25-80	0510390 024
	V5025A	25-80	0510390 024
	V5049A	15-65	0510390 024
	V5049B	15-65	0510390 024
	V5050A	15-80	0510390 024
	V5095A	15-80	0510390 024
	V5328A	15-80	0510390 024
	V5329A	15-80	0510390 024
ITT Dräger	PSVF	15-32	0510390 026
	PSVD	15-32	0510390 026
	SVF	15-32	0510390 026
	SVD	15-32	0510390 026

Important accessories for the AVM 322 linear actuator

Type	Description
0313529 001	Split-range unit, fitted in separate junction box
0500420 002	4...20 mA feedback module
0500570 003	Continuous 230 V module
0510220 001	CASE Drives configuration tool
0510600 001	Cable module, 1.2 m, 3-wire, PVC
0510600 002	Cable module, 1.2 m, 3-wire, halogen-free
0510600 003	Cable module, 1.2 m, 6-wire, PVC
0510600 004	Cable module, 1.2 m, 6-wire, halogen-free
0510600 005	Cable module, 5 m, 3-wire, PVC
0510600 006	Cable module, 5 m, 3-wire, halogen-free
0510600 007	Cable module, 5 m, 6-wire, PVC
0510600 008	Cable module, 5 m, 6-wire, halogen-free

AVM 1*5 , AVF 12* , AV* 234 electric linear actuator for non-SAUTER valves and retrofitting



Model series		AVM				AVM			AVF				AVM	AVF		
Type		105				115			124		125		234	234		
Version		F100	F120	F122	SF132	F120	F122	SF132	F130	F230	SF132	SF232	SF132	SF132	SF132	SF232
Voltage	230 V AC	•	•			•			•	•			• ¹⁾	• ¹⁾	• ¹⁾	
	24 V AC			•	•		•	•			•	•				
	24 V DC				•			•								
Positioning signal	2-point	•	•	•	•	•	•	•			•	•	•	•	•	•
	3-point	•	•	•	•	•	•	•	•	•			•	•	•	•
	0...10 V				•			•			•	•	•	•	•	•
	4...20 mA										•	•	•	•	•	•
Feedback	0...10 V						•				•	•	•	•	•	•
					•											•
Running time for the nominal stroke [s]		30	120	120	60 120	120	120	60 120	60	60	60	60	160 240	80	160	80 240
Return time for the nominal stroke [s]									18		18				30	30
Nominal stroke (mm)			8			8				8			40		40	
Pushing force [N]			250			500				500			2500		2000	
Spring return	without power, closes the valve								•		•				•	
	without power, opens the valve									•		•				•

¹⁾ Requires accessory 0372332 001

Manufacturer	Type	DN	Fitting kit
SAUTER	V4F/S/N	15-32	0372338 001
	V4F/S/N	40-100	0372338 002
	B4F/S/N	15-32	0372338 001
	B4F/S/N	40-100	0372338 002
	V14R/B14R	15-25-40	0372338 001
	V6F/G/S	15-50	0372338 001
	V6F/G/S	65-150	0372338 002
	B6F/G/S	15-50	0372338 001
	B6F/G/S	65-150	0372338 002
	B6D	15-65	0372338 001
	B16D/B16E	25-80	0372338 001
	VXD/VXE	15-50	0372338 001
	VXD/VXE	65-100	0372338 002
	BXD/BXE	15-50	0372338 001
	BXD/BXE	65-100	0372338 002
	V6R/B6R	15-50	0372338 001
Johnson Controls	VBD-4xx4	50-150	0372377 001
	VBD-4xx8	50-150	0372377 001
	VBF-0xx4	15-150	0372377 001
	VBF-0xx8	15-150	0372377 001
	VBF-2xx4	50-100	0372377 001
	VBF-2xx8	50-100	0372377 001
	VBB-2xxx	15-100	0372377 001
	VG82../VG84..	50-150	0372377 001
VG88../VG89..	50-150	0372377 001	
Honeywell	V5015A	100-150	0372378 002
	V5016A	100-150	0372378 002
	V5025A	100-150	0372378 002
	V5049A	80-150	0372378 002
	V5049B	80-150	0372378 002
	V5050A	100-150	0372378 002
Frese	V5329C	15-80	0372378 001
	Optima compact	50-80	0510390 052
	Optima compact	100-150	0510390 053

AVM 1*5 , AVF 12*, AV* 234 electric linear actuator for non-SAUTER valves and retrofitting



Model series		AVM				AVM			AVF				AVM	AVF	
Type		105				115			124	125		234	234		
Version		F100	F120	F122	SF132	F120	F122	SF132	F130	F230	SF132	SF232	SF132	SF132	SF232
Voltage	230 V AC	•	•			•			•	•			• ¹⁾	• ¹⁾	• ¹⁾
	24 V AC			•	•		•	•			•	•	•	•	•
	24 V DC				•			•					•	•	•
Positioning signal	2-point	•	•	•	•	•	•	•			•	•	•	•	•
	3-point	•	•	•	•	•	•	•	•	•			•	•	•
	0...10 V				•			•			•	•	•	•	•
	4...20 mA										•	•	•	•	•
Feedback	0...10 V				•		•				•	•	•	•	•
Running time for the nominal stroke [s]		30	120	120	35 60 120	120	120	60 120	60	60	60	60	80 160 240	80	80 160 240
	Return time for the nominal stroke [s]								18		18			30	30
Nominal stroke (mm)			8			8				8			40	40	
Pushing force [N]			250			500				500			2500	2000	
Spring return	without power, closes the valve								•		•			•	
	without power, opens the valve									•		•			•

¹⁾ Requires accessory 0372332 001

Manufacturer	Type	DN	Fitting kit
Siemens	WF21/VXF21	25-80	0372376 010
	WF21/VXF21	100	0372376 014
	WF31/VXF31	15-80	0372376 010
	WF31/VXF31	100-150	0372376 014
	WF40/VXF40	15-80	0372376 010
	WF40/VXF40	100-150	0372376 014
	WF41/VXF41	50	0372376 010
	WF41/VXF41	65-150	0372376 014
	WF45	50	0372376 010
	WF45	65-150	0372376 014
	WF52	15-40	0372376 010
	WF61	15-40	0372376 010
	WF61	65-150	0372376 014
	VXF61	15-50	0372376 010
	VXF61	65-150	0372376 014
	WG41	15-50	0372376 010
	WG41	15-50	0372376 010
	VPF52[E/F]	15-40	0372376 010
	WG44/VXG44	15-50	0372273 001
	WG45/VXG45	15-50	0372273 001
ITT Dräger	PSVF	40-50	0372389 002
	PSVD	40-50	0372389 002
	SVF	40-50	0372389 002
	SVD	40-50	0372389 002

Important accessories for the AVM 1*5, AVF 12*, AV* 234 linear actuators

	Type	Description
AVM 105	0372145 001	Auxiliary change-over contacts, single
AVM 115	0372145 002	Auxiliary change-over contacts, double
	0372320 001	Hexagon key for manual adjustment
AVF 124	0370880 001	Mechanical stroke indicator
AVF 125S	0370881 001	Auxiliary change-over contacts, single, infinitely variable
	0313529 001	Split-range unit for adjusting sequences, suitable for all actuators
AVM 234S	0372332 001	Module pluggable for 230 V supply voltage continuous, 2- or 3-point (for AV* 234, AVN 224)
AVF 234S	0372332 002	Module pluggable for 100 V supply voltage continuous, 2- or 3-point (for AV* 234, AVN 224)
	0372333 001	2 auxiliary change-over contacts, infinitely variable, load 6 [2]A (for AV* 234, AVN 224)
	0372462 001	CASE Drives PC tool for configuration of actuators via computer

vialoq ADM 15 electric rotary actuator for non-SAUTER valves and retrofitting

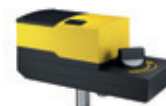

Model series		ADM							
Type		322							
Version		F120	F122	HF120	HF122	PF120	PF122	SF122	SF152
Voltage	230 V AC	•		•		•			
	24 V AC		•		•		•	•	•
	24 V DC		•		•		•	•	•
Positioning signal	2-point	•	•	•	•	•	•		•
	3-point	•	•	•	•	•	•		•
	0...10 V							•	•
	2...10 V							•	
	0...20 mA							•	
Feedback	4...20 mA							•	•
	0...10 V							•	•
Running time [s]		120	120	120	120	120	120	120	30
		240	240	240	240	240	240		60
Torque [Nm]		15							
Rotation angle		≥90°							
With integrated double auxiliary contacts				•	•				
With integrated 1000 Ω potentiometer						•	•		

Manufacturer	Type	DN	Fitting kit
SAUTER	MH32R...	15-50	0510240 013
	MH42R...	15-32	0510240 013
	DE16X...	25-65	0510240 016
	DE16X...	80-100	0510240 017
Honeywell	DR...	15-65	0510390 002
	ZR...	15-65	0510390 002
Danfoss	HRB 3	15-50	0510390 003
	HRB 4	15-50	0510390 003
Calefi	610	20-40	0510390 004
	611	20-40	0510390 004
	612	20-40	0510390 004
Coster	VSG3..	20-50	0510390 005
	VFG...	20-100	0510390 005
	VSF...	40-100	0510390 005

Important accessories for the ADM 322 rotary actuator

Type	Description
0313529 001	Split-range unit, fitted in separate junction box
0500420 002	4...20 mA feedback module
0500570 003	Continuous 230 V module
0510220 001	CASE Drives configuration tool
0510600 001	Cable module, 1.2 m, 3-wire, PVC
0510600 002	Cable module, 1.2 m, 3-wire, halogen-free
0510600 003	Cable module, 1.2 m, 6-wire, PVC
0510600 004	Cable module, 1.2 m, 6-wire, halogen-free
0510600 005	Cable module, 5 m, 3-wire, PVC
0510600 006	Cable module, 5 m, 3-wire, halogen-free
0510600 007	Cable module, 5 m, 6-wire, PVC
0510600 008	Cable module, 5 m, 6-wire, halogen-free

Valve specification – calculating with the tools from SAUTER.

SAUTER valve slide rule.

SAUTER has further developed its practical valve slide rule. You can use it to specify the valve nominal diameter depending on the flow rate for liquids and saturated steam. You can order the slide rule at your sales partner or sales consultant.

SAUTER VALVEDIM software.

A tried and tested tool for convenient valve and actuator specification, SAUTER provides installers and project engineers with its SAUTER VALVEDIM PC software. The tool comprises three function levels:

1. Valve and actuator specification
 - using recommended values for a rough specification of the required versions and variables;
 - based on the existing or stipulated installation values for the definitive specification of the required versions and variables.
2. Selection of the valve and the suitable actuator based on characteristics.
3. Direct transfer of the results to the project documentation.

VALVEDIM is available via your SAUTER branch.

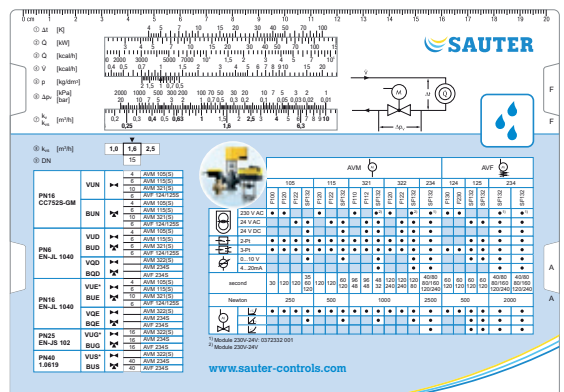

Valve specification

Valve specification – manual calculation

Here you will find all the necessary information for the manual valve specification.

[1] Variables, constants and formulas

Variable	Description	Value	Unit
\dot{V}	Volume flow		m^3/h
\dot{Q}_{to}	Supplied heat per unit of time (heat flow)		kW, kJ/h
\dot{Q}_{from}	Supplied heat per unit of time (heat flow)		kW, kJ/h
Δt	Temperature difference		K
c_w	Specific thermal capacity of water	4,19 $= 1,164 \cdot 10^{-3}$	kJ/(kg·K) kWh/(kg·K)
ρ_w	Density of water	Supposition: $\rho_w = \text{const.} = 1000$	kg/m^3
Δp_v	Pressure difference across the valve		bar, kPa
k_v	Calculated flow rate for the valve		m^3/h
k_{vs}	Actual flow rate for the valve at nominal stroke, selected according to table or chart		m^3/h

[2] Calculation formula for k_v

$$k_v = \dot{V} \cdot \sqrt{\frac{1 \text{ bar}}{\Delta p_v}}$$

[3] Diagram

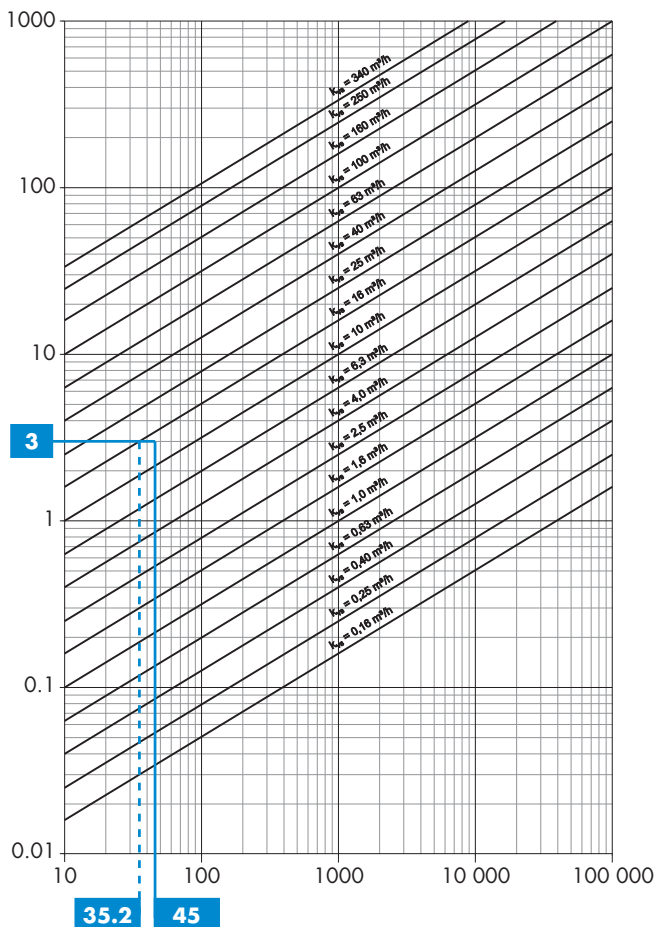

[4] Calculations

The following are given:

$$\dot{Q}_{\text{to}} = 70 \text{ kW} \approx 250\,000 \text{ kJ/h}$$

$$\Delta t = 20 \text{ K}$$

$$\Delta p_v = 45 \text{ mbar} = 4.5 \text{ kPa} \text{ (corresponds to 450 mm water column)}$$

To be found:

$$\dot{V}, k_v$$

Approximate calculation of \dot{V}

Assumption: $\dot{Q}_{\text{to}} = \dot{Q}_{\text{from}}$

$$\dot{Q}_{\text{to}} = \dot{Q}_{\text{from}} = \dot{V} \cdot c_w \cdot \Delta t \cdot \rho_w$$

$$\Rightarrow \dot{V} = \frac{\dot{Q}_{\text{to}}}{c_w \cdot \Delta t \cdot \rho_w}$$

$$\Rightarrow \dot{V} = \frac{70}{1.164 \cdot 10^{-3} \cdot 20 \cdot 1000} \cdot \frac{\text{kW} \cdot (\text{kg} \cdot \text{K}) \cdot \text{m}^3}{\text{kWh} \cdot \text{K} \cdot \text{kg} \cdot \text{h}} \approx 3 \text{ m}^3/\text{h}$$

Calculation of k_v

$$k_v = 3 \text{ m}^3/\text{h} \cdot \sqrt{\frac{1 \text{ bar}}{0.045 \text{ bar}}} \approx 14.1 \text{ m}^3/\text{h}$$

Determination of flow rate

Determination of k_v from the diagram

$$\underline{k_{vs} = 16 \text{ m}^3/\text{h}}$$

Example plotted: Given are the volume flow ($3 \text{ m}^3/\text{h}$) and a desired Δp_v of 45 mbar, which results in a k_v value of 14.1 m^3/h . The k_{vs} values entered are deliverable values. Selected: A valve with $k_{vs} = 16 \text{ m}^3/\text{h}$, which results in a pressure difference Δp_v of 35.2 mbar.

Application overview as table

		Valve type																		
		VUL	BUL	VUT	VDL VCL	BKR	BKT BKL	BUN	BUD BQD BUE BQE	BUG	BUS	VKR	VKAI	VUN	VUD VQD VUE VQE	VUG	VUP	VUS	DEF	MH M3R M4R
Application	Schematic Position	PN16	PN16	PN16	PN16 PN25	PN40	PN40	PN16	PN6 PN16	PN16 PN25	PN40	PN40	PN40	PN16	PN6 PN16	PN16 PN25	PN25	PN40	PN16	PN6
Intelligent unitary control		•	•	•	•	•						•								
Ventilation/ airconditioning preheater	1 1				•	•	•	•	•	•	•			•	•	•	•	•		•
Ventilation/air-conditioning cooler	1 2				•	•						•		•	•	•	•	•		
Ventilation/ air-conditioning steam humidifier	1 3															•		•		
Ventilation/ air-conditioning reheater	1 4					•	•	•	•	•	•			•	•	•	•	•		
Chilled ceiling	2	•	•	•	•	•	•	•				•	•	•	•					
Underfloor heating	2	•	•	•	•	•		•	•			•		•	•					
Radiators	2	•	•	•	•															
Underfloor devices	3	•	•	•	•															
Heating groups	4					•	•	•	•	•	•			•	•	•	•	•		•
Cooling tower (regulating valve)	5 1						•							•						
Cooling tower (shut-off damper)	5 2																			•
Multi-boiler installation (regulating valve)	6 1					•		•	•	•	•			•	•	•	•	•		
Multi-boiler installation (shut-off damper)	6 2						•	•	•	•		•		•	•	•	•	•	•	•
Local heating	7					•		•	•	•	•	•		•	•	•	•	•		
District heating	8									•	•					•	•	•		
Page numbers		7	7	8	11/12	15/17	16/18	21	24/25	26	28	15/17	16/18	21	24/25	26	27	28	31	33

SAUTER CASE Drives



USB/RS232



CASE *Drives*

SAUTER CASE Drives (accessory 0372461001) allows you to set and read the actuator parameters on site (e.g. running time and operating hours). Accordingly, SAUTER CASE Drives can also be used as a diagnostic and maintenance tool. The connection is via a serial port on the PC and the socket on the actuator. The set consists of:

- software incl. installation and operating instructions
- fitting instructions
- connection plug and cable
- interface converter for the PC

The application is designed for commissioning and service technicians and experienced operators.

Graphical overview/application profiles

The numbering relates to the *Schematic* and *Position* columns in the adjacent table representation of the application profiles.

1 Ventilation and air-conditioning

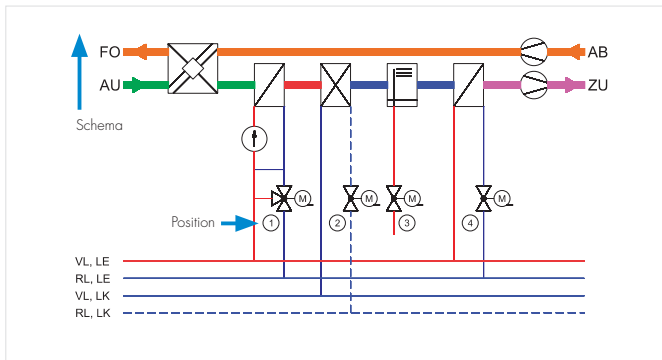

2 Chilled ceilings, underfloor heating and radiators

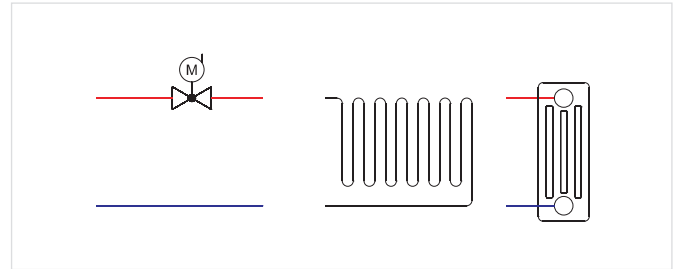

3 Underfloor units

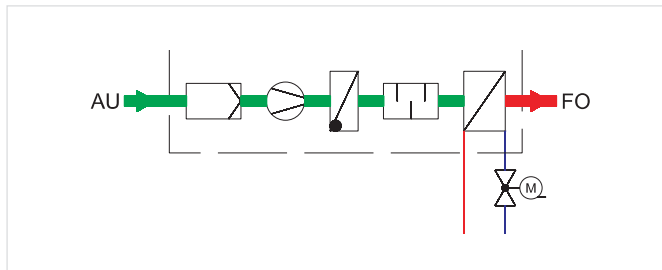

4 Static heating

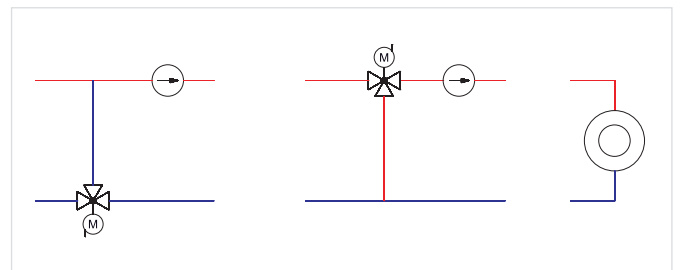

5 Cooling towers

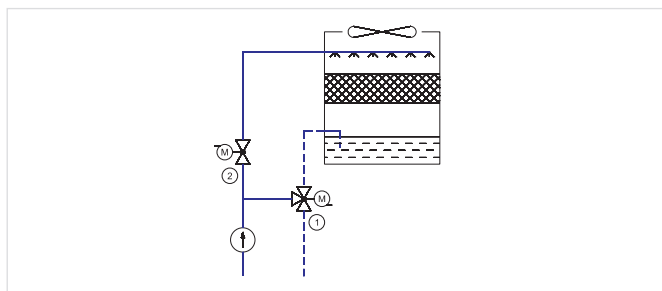

6 Multi-boiler installations

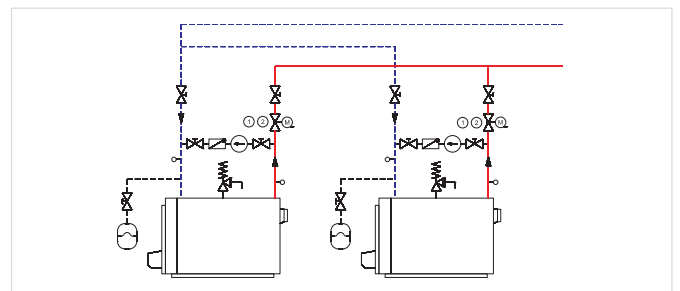

7/8 Local heating, district heating

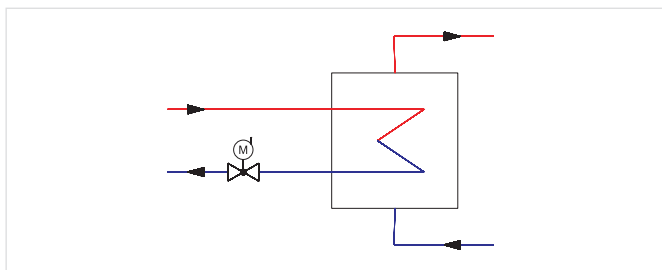

9 4-pipe system



Systems

Components

Services

Facility Management

P100014407 - V2

www.sauter-controls.com

Subject to change. © 2016 Fr. Sauter AG

**SAUTER**
Creating Sustainable Environments.