

VJ-628

Operation Manual

Operations and Maintenance Methods

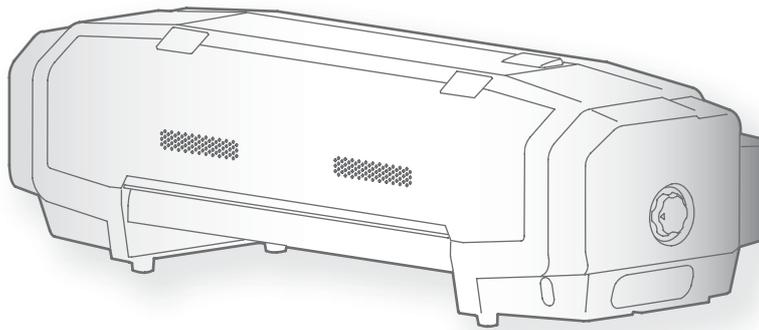

-
- Unauthorized copying or duplication of the whole or part of the contents of this manual is prohibited.
 - Every care has been taken in writing the contents of this manual, but please contact MUTOH or the dealer you purchased the product from if you find any unclear, erroneous or otherwise unsatisfactory content in the manual.
 - Please be aware that MUTOH will not be liable in any way for failures or accidents that result from handling or operating the printer according to any procedures other than those set forth in this manual.
 - Company names and product names that appear in this manual are registered trademarks of the respective companies.

For Users in Europe



The CE marking is a mandatory European marking for certain product groups to indicate conformity with the essential health and safety requirements set out in European Directives.

By affixing the CE marking, the manufacturer, his authorized representative, or the person placing the product on the market or putting it into service ensures that the item meets all the essential requirements of all applicable EU directives and that the applicable conformity assessment procedures have been applied.

For Users in the United States

This equipment has been tested and found to comply with the limits for a Class A digital device, pursuant to Part 15 of the FCC Rules.

These limits are designed to provide reasonable protection against harmful interference when the equipment is operated in a commercial environment.

This equipment generates, uses, and can radiate radio frequency energy and, if not installed and used in accordance with the instruction manual, may cause harmful interference to radio communications.

Operation of this equipment in a residential area is likely to cause harmful interference in which case the user will be required to correct the interference at his own expense.

Warranty Limitations

- MUTOH INDUSTRIES LTD. warrants part repair or replacement as a sole measure only if a failure is found in the system or in the materials and workmanship of the product the seller produced.
However, if the cause of failure is uncertain, decide the action after due mutual consultation.
- The warranty shall not apply to any direct or indirect loss, or compensation for the loss due to the product that has been subject to misuse, neglect, or improper alternation.

Chapter 1 Basic Operations

Introduction	6
Name of each part	6
System configurations of this product	7
Displaying the Printing Preferences screen of printer driver	8
Launching/Displaying/Finishing ValueJet Status Monitor (VSM)	9
Launching ValueJet Finder	10
Displaying Help or Manual	11
Conditions of usable media	12
Cautions in using this product	13
Powering ON/OFF	14
Turning the power ON	14
Turning the power OFF	14
Printing	15
Setting up media	15
Adjusting image quality	17
Correcting paper feed	22
Nozzle check and cleaning	27
Starting printing	29
Pausing/Restarting printing	30
Canceling printing	30
Forwarding/Rewinding media	31
Forwarding/rewinding media from printer driver/VSM	31
Cutting media	32
Cutting from the operation panel	32
Cutting from printer driver/VSM	32
Cutting by hand	33
Cutting automatically	34

Chapter 2 Advanced Operations

Changing head height	36
Releasing pressure arms individually	37
Advanced settings	38
Setting auto cut	38
Setting the vacuum fan	40
Setting the heater	41

Chapter 3 Maintenance

Maintenance	44
Checking ink and replacing ink cartridge	45
Checking ink level	45
When it becomes time to replace ink cartridge	46
Replacing ink cartridge	47
Emptying waste ink tank	49
Cleaning each part	51
Head cleaning	51
Cleaning of cleaning wiper	53
Cleaning of print head circumference	55
Inside cleaning	57
Replacing consumable parts	58
Replacing absorption material for the flushing box	58
Replacing cutter	61
Transporting and long-term storage	62
Transporting	62
Initial charging	67
Storing for a long time	70

Chapter 4 Appendix

Troubleshooting	72
Handling messages/error messages	72
Specifications of this product	75
Drawing area	75
List of specifications	76

Chapter 1 Basic Operations

Introduction	6
Name of each part.....	6
System configurations of this product	7
Displaying the Printing Preferences screen of printer driver.....	8
Launching/Displaying/Finishing ValueJet Status Monitor (VSM).....	9
Launching ValueJet Finder	10
Displaying Help or Manual.....	11
Conditions of usable media.....	12
Cautions in using this product	13
Powering ON/OFF	14
Turning the power ON.....	14
Turning the power OFF.....	14
Printing	15
Setting up media.....	15
Adjusting image quality	17
Correcting paper feed	22
Nozzle check and cleaning	27
Starting printing	29
Pausing/Restarting printing	30
Canceling printing	30
Forwarding/Rewinding media	31
Forwarding/rewinding media from printer driver/VSM	31
Cutting media	32
Cutting from the operation panel.....	32
Cutting from printer driver/VSM	32
Cutting by hand.....	33
Cutting automatically	34

Introduction

Name of each part

Printer's main body

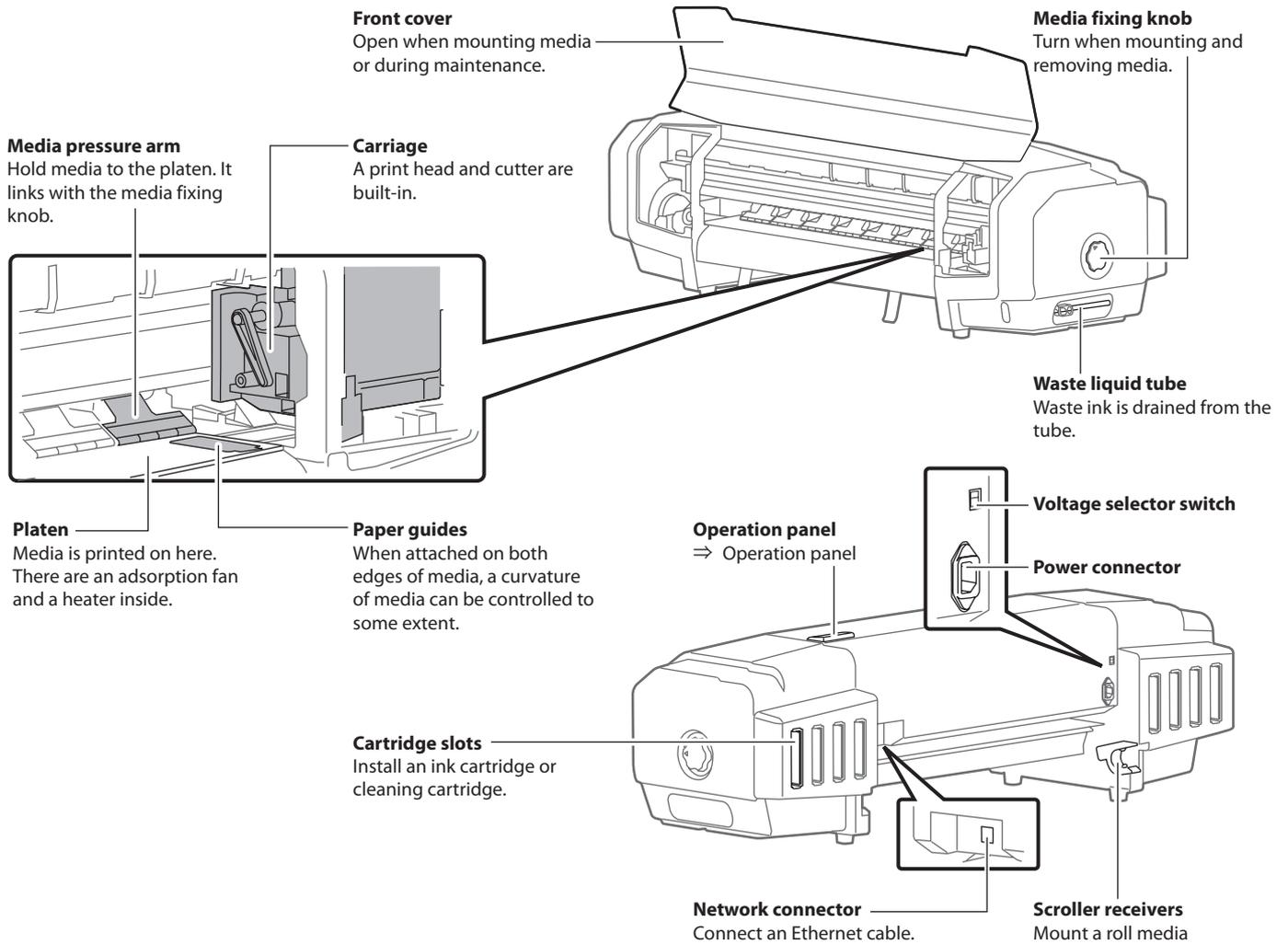

Operation panel

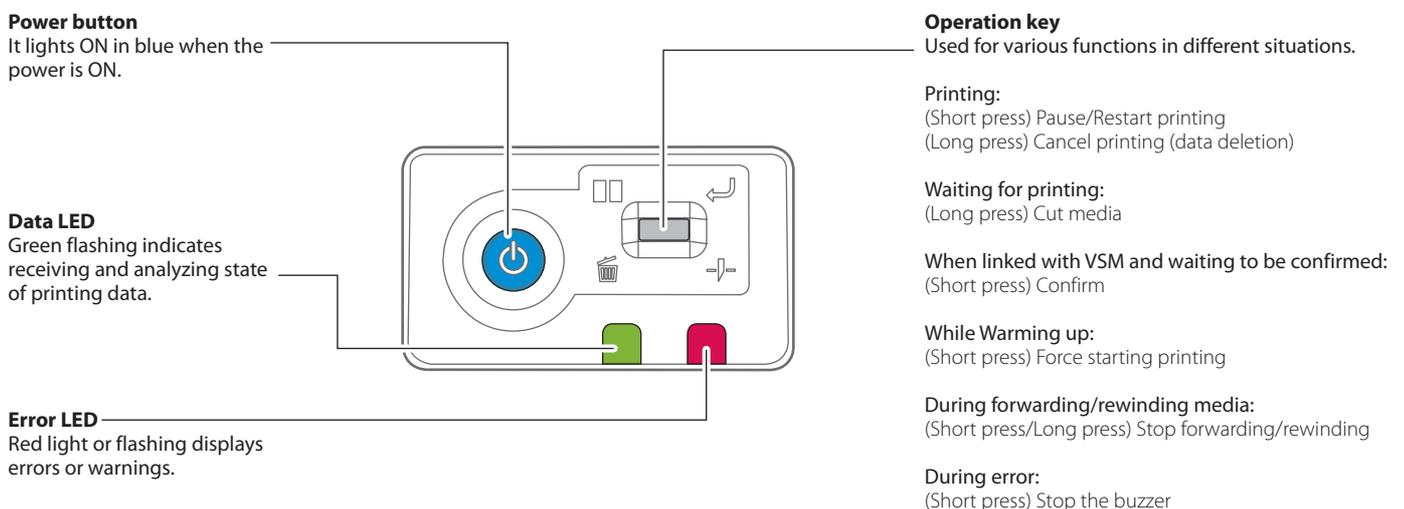

System configurations of this product

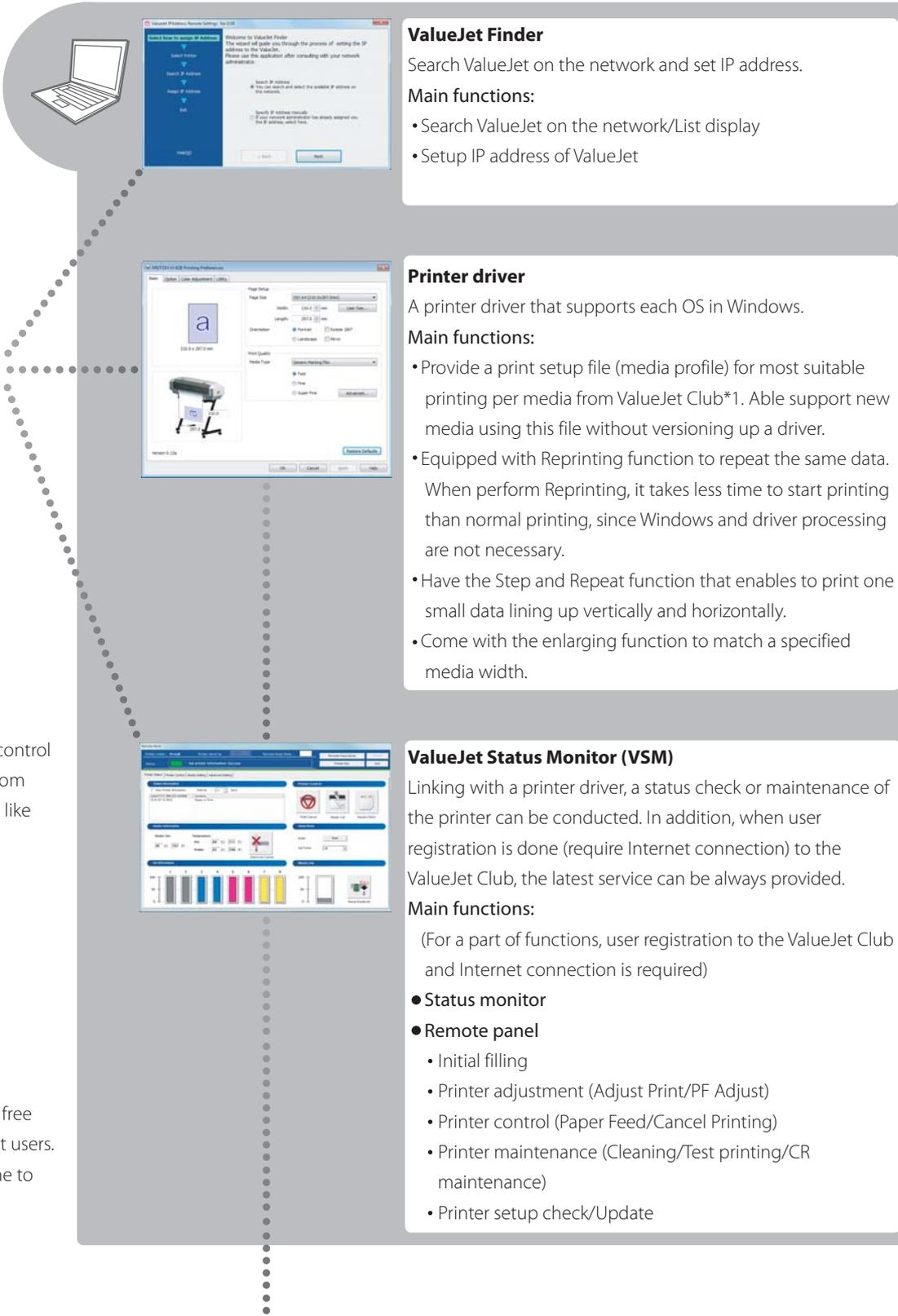

ValueJet Finder
 Search ValueJet on the network and set IP address.
Main functions:

- Search ValueJet on the network/List display
- Setup IP address of ValueJet

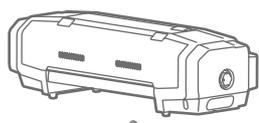

Printer driver
 A printer driver that supports each OS in Windows.
Main functions:

- Provide a print setup file (media profile) for most suitable printing per media from ValueJet Club*1. Able support new media using this file without versioning up a driver.
- Equipped with Reprinting function to repeat the same data. When perform Reprinting, it takes less time to start printing than normal printing, since Windows and driver processing are not necessary.
- Have the Step and Repeat function that enables to print one small data lining up vertically and horizontally.
- Come with the enlarging function to match a specified media width.



ValueJet Status Monitor (VSM)
 Linking with a printer driver, a status check or maintenance of the printer can be conducted. In addition, when user registration is done (require Internet connection) to the ValueJet Club, the latest service can be always provided.
Main functions:

(For a part of functions, user registration to the ValueJet Club and Internet connection is required)

- **Status monitor**
- **Remote panel**
 - Initial filling
 - Printer adjustment (Adjust Print/PF Adjust)
 - Printer control (Paper Feed/Cancel Printing)
 - Printer maintenance (Cleaning/Test printing/CR maintenance)
 - Printer setup check/Update

VSM Mobile
 Status check and remote control of ValueJet can be done from personal digital assistance like your iPhone and Android.
Main functions:

- Status monitor
- Remote panel

***1 ValueJet Club**
 This Web service provides free useful contents to ValueJet users. Have user registration done to use various services.
Main functions:

- Downloading the latest application and manual
- Downloading media profiles
- Printer status check (When using the printer information supplying service of VSM)



ValueJet Club server
 Connect to the ValueJet Club.
<https://valuejetclub.mutoh.co.jp/mutoh/guser>

Displaying the Printing Preferences screen of printer driver

[1] Windows 8/Windows 8.1

Display the charm bar on Desktop, and click [Settings]. Click [Control Panel] - [View devices and printers].

Windows 7

Click [Start] - [Devices and Printers].

Windows Vista

Click [Start] - [Control Panel] - [Printer].

Windows XP

Click [Start] - [Printers and Faxes].

[2]

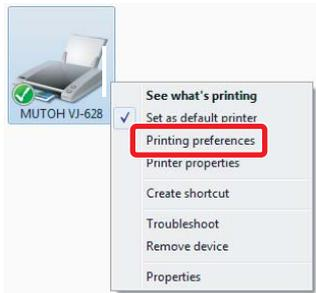

Right click the "MUTOH VJ-628" icon and click [Printing preferences].

- The "Printer Configuration" dialog box opens only at the first click.
- The Printing Preferences screen of printer driver opens after the second click.

[3]

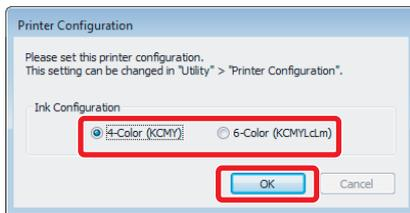

Select the ink color configuration and click [OK].

- After clicking, the Printing Preferences screen of printer driver opens.

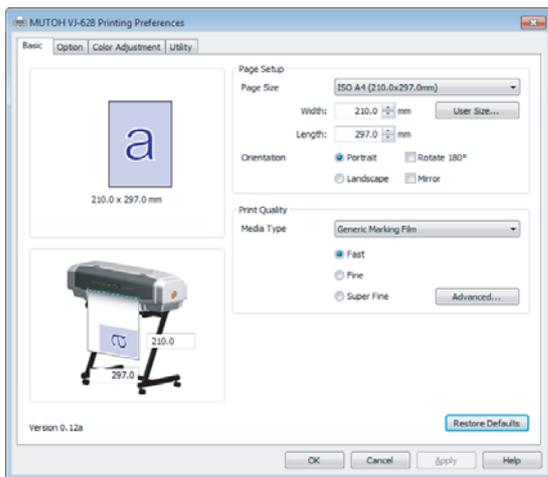

Printing Preferences screen of printer driver

Launching/Displaying/Finishing ValueJet Status Monitor (VSM)

Launching VSM



Windows 8/Windows8.1

- In the [Start] screen, click [Desktop].
- Double click the VSM icon on the Desktop.

Windows7/Vista/XP

Double click the VSM icon on the Desktop.

Note

Launching from the Start Menu of Windows

- Windows 8/Windows8.1
Right click somewhere the [Start] screen tiles are not displayed to display the application bar, and click [All Apps].
- Windows7/ Vista/XP
From the [Start] menu, click [All Programs] (or [Programs]) - [MUTOH] - [ValueJet Status Monitor].

Displaying VSM



Double click the VSM icon in the task tray.

Displaying remote panel

The remote panel is used to view this product's status or operate.

Click [Remote Panel].

- The remote panel opens.

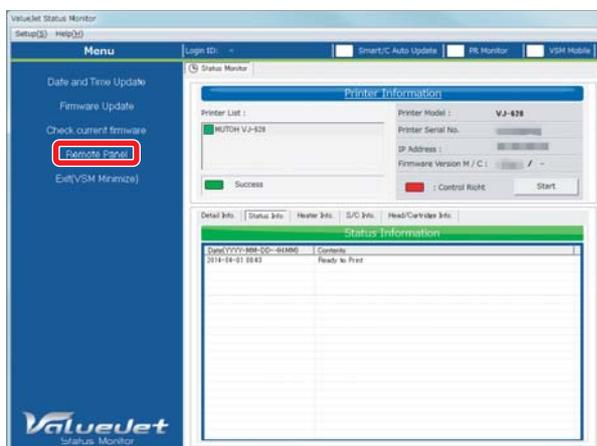

Finishing VSM



Right click the VSM icon in the task tray, and click [Exit].



When using normally, do not finish VSM. When closing the VSM window, click [Settings] - [Close].

Windows8.1

Click the Down Arrow in the [Start] screen.
Click [ValueJet Status Monitor].

Launching ValueJet Finder

Windows 8/Window8.1

Right click somewhere the [Start] screen tiles are not displayed to display the application bar, and click [All Apps].
Click [VJ Finder].

Windows7/ Vista/XP

From the [Start] menu, click [All Programs] (or [Programs]) - [MUTOH] - [ValueJet Finder].

Displaying Help or Manual

Printer driver

Display the Printing Preferences screen of printer driver, and click [Help].

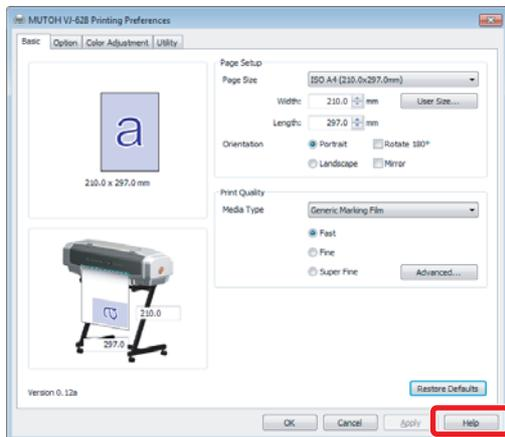

ValueJet Status Monitor

- [1] Set the software CD ("Driver & Applications") that comes with the product to CD-ROM drive of your computer.
- [2] Display the contents of CD-ROM.
- [3] Open the [Manual] folder, and double click "VSME-A-xx.pdf".

ValueJet Finder

Launch ValueJet Finder, and click [Help].

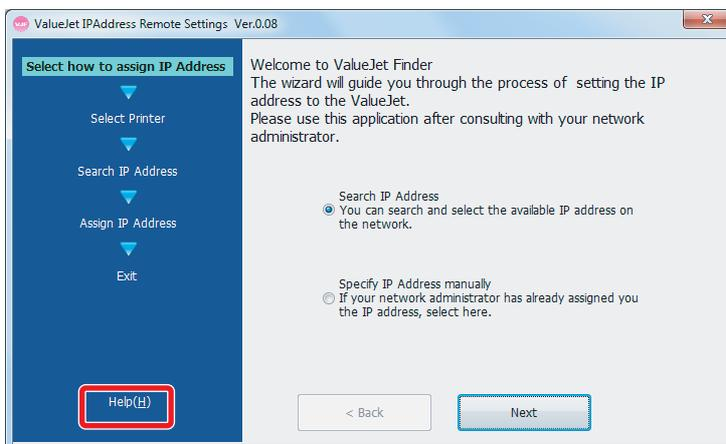

Conditions of usable media

Roll media can be used in this product.

Usable size

Maximum width		630mm (If paper tube > media width, then paper tube width)
Maximum thickness	Head height when Low	0.3mm
	Head height when High	1.3mm
Roll outer diameter		150mm
Paper tube diameter		2 or 3 inches
Weight		9 kg or less

Cautions when handling media

- Please use recommended media. Contact the sales store for recommended media.
- Be cautious of expansion and contraction of media from temperature and humidity. After opening an unopened media, leave the media for approximately 30 minutes to adjust to environments.
- Do not use media with folds, scratches, tears, curvatures, winding curl and weaving.
- Do not leave a roll media set in this product for a long time. The media can be curled becoming unsuitable for printing. When not using for a long time, remove a roll media and store in its original package box.

Cautions in using this product

Please use this product periodically

It is recommended to use this product once a week. When left unused for a long time, the print head nozzles can get clogged causing damage.

Conduct periodic maintenance

This product requires daily maintenance.

- Check the nozzle before and after printing.
If nozzle clog is found, conduct a head cleaning.
- Clean the cleaning wiper once a week.
- When this product is not used for a long time (a week or more), conduct a head cleaning once a week.
- Clean its exterior and inside once a month.
- Drain waste ink in the waste liquid tank periodically.

Some parts need to be replaced periodically

In this product, there are some parts required to be replaced after a long-term use.

- Parts required to be replaced by users: absorption material for the flushing box, cutter
- Parts required to be replaced by service personnel: Various motors, print head

Powering ON/OFF

Turning the power ON

[1] Close the front cover.

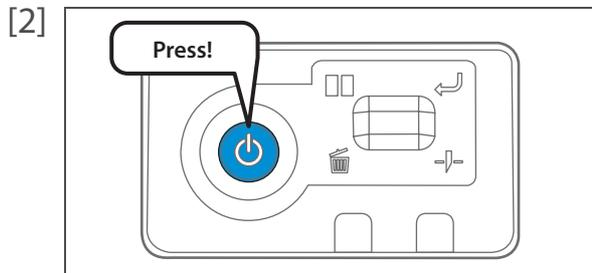

Press the power button of this product to turn the power ON.

- The blue light becomes ON.
- This product starts its initialization operations.

Turning the power OFF

[1] Make sure printing is done.

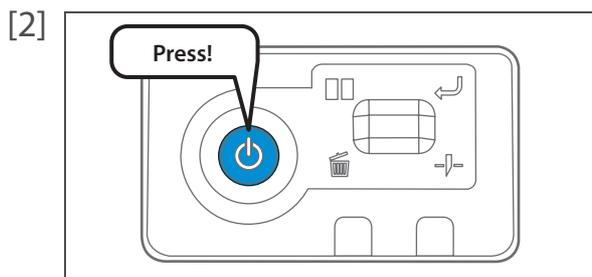

Press the power button of this product to turn the power OFF.

- The blue light becomes OFF.
- This product starts its powering off operations.

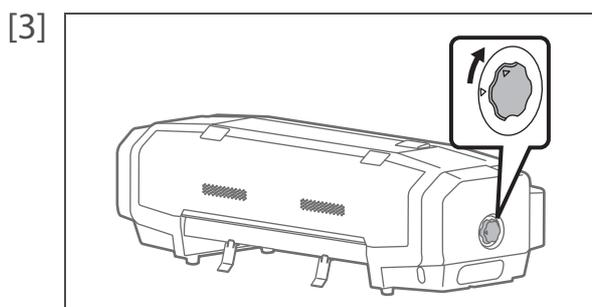

Turn the media fixing knob to release the lock.



Note

When not using this product, release the lock of the media fixing knob regardless of power being OFF.

Setting up media

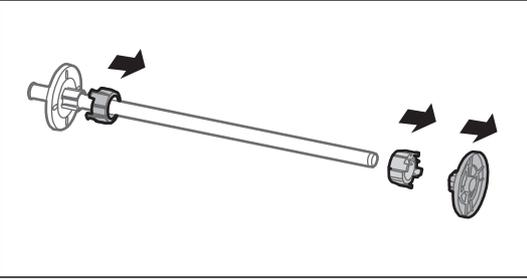
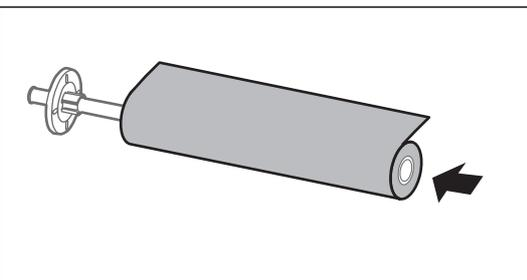
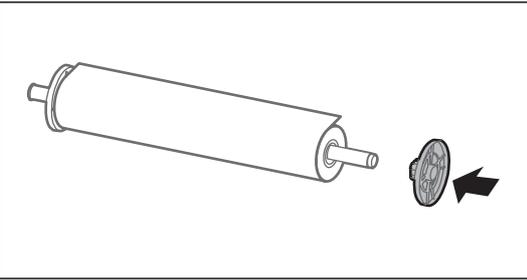
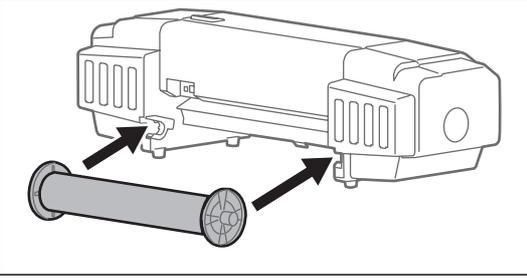
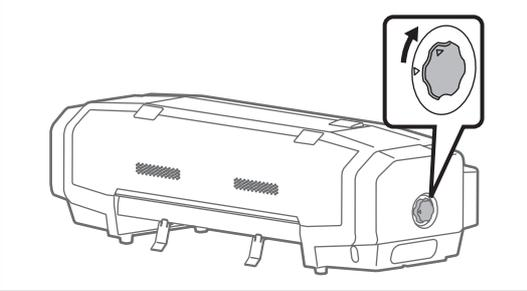
- [1]  Remove the 3 inches adaptor and media stopper (movable) from the scroller.
-  **Note**
- When using a roll media with 3 inches paper tube diameter, leave the 3 inches adaptor on.
- [2]  Attach a roll media to the scroller.
-  **Note**
- Attach the media in the rolling direction to be the same with the figure.
 - Push in the roll media so that there is no space with the media stopper (fixed).
- [3]  Push in the media stopper (movable) until there is no space with the roll media.
- [4]  Attach the scroller to the scroller receivers.
-  **Note**
- Attach the media stopper (movable) to face to the right, when this product is looked from its back.
- [5]  Turn the media fixing knob to release the lock.

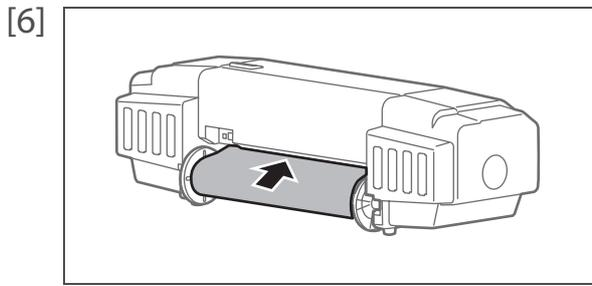

Let the roll media pass through the paper feed slot.

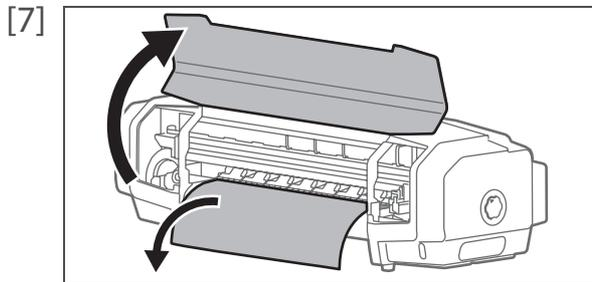

- Open the front cover.
- Pull out the media roller from the front side of the product.



Note

If the media gets loose, rewind the scroller to correct the looseness.

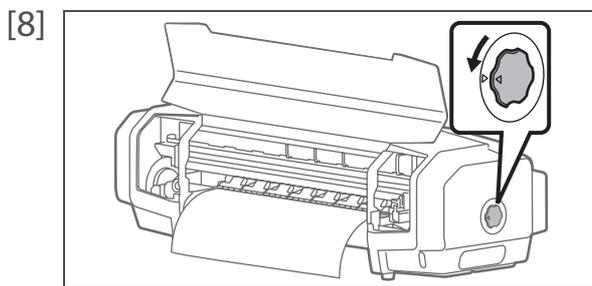

Turn the media fixing knob to lock.

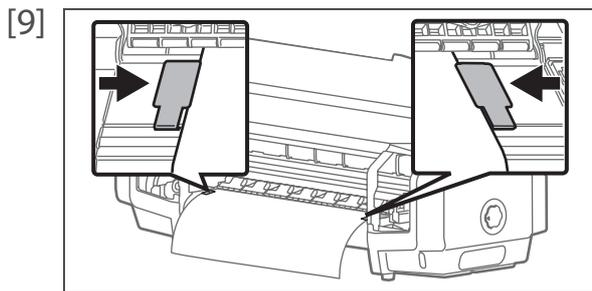

Set the paper guides to media.

- Slide from both sides of platen and set.

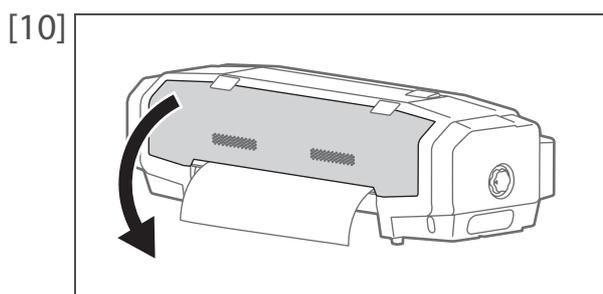

Close the front cover.

Adjusting image quality

For the following cases, please conduct this adjustment.

- Using this product for the first time.
- Changing a media type.

For any other cases, please proceed to ["Nozzle check and cleaning" on page 27](#).

This adjustment corrects print shifting that can be generated during bidirectional printing per media type.

Bidirectional printing

The print head goes back and forth on media during printing. When printing is done for both back and forth directions, it is called "bidirectional printing". Though a printing speed gets faster with a bidirectional printing, a slight shifting can be generated in the print joints. "Image quality adjustment" corrects such shifting.

Setup method of bidirectional printing

[1] Display the Printing Preferences screen of printer driver.

 ["Displaying the Printing Preferences screen of printer driver" on page 8](#)

[2]

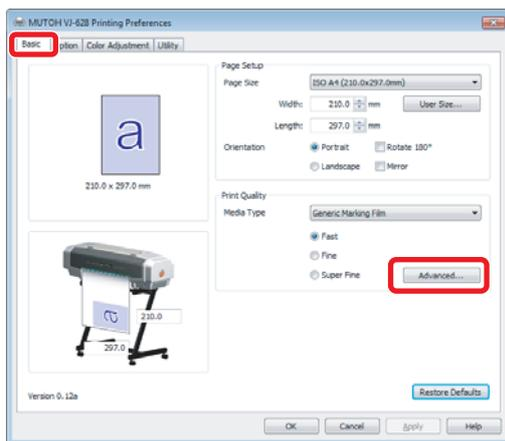

Click [Advanced...] under the [Basic] tab.

[3]

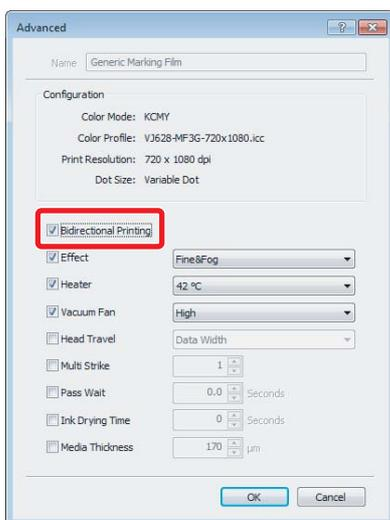

Place a checkmark in [Bidirectional Printing].



Note

- By default, it is checked.

Steps for image quality adjustment

1. Media thickness

[1] Display the Printing Preferences screen of printer driver.

 ["Displaying the Printing Preferences screen of printer driver" on page 8](#)

[2]

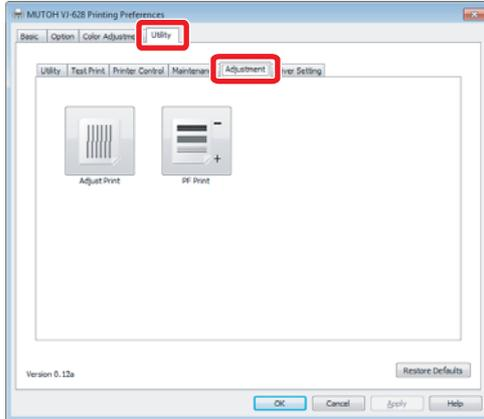

Click the [Adjustment] tab under the [Utility] tab.

[3]

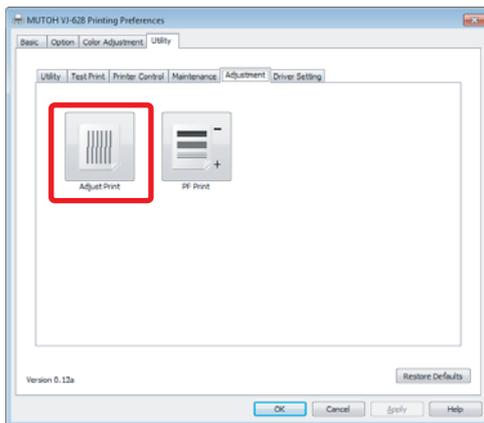

Click [Adjust Print]

- The remote panel of ValueJet Status Monitor (VSM) launches.



Note

VSM can be launched directly.

 ["Launching VSM" on page 9](#)

[4] Click [Start] in [Adjust Print] of the [Media Setting] tab.

- The [Adjust Print] window opens.

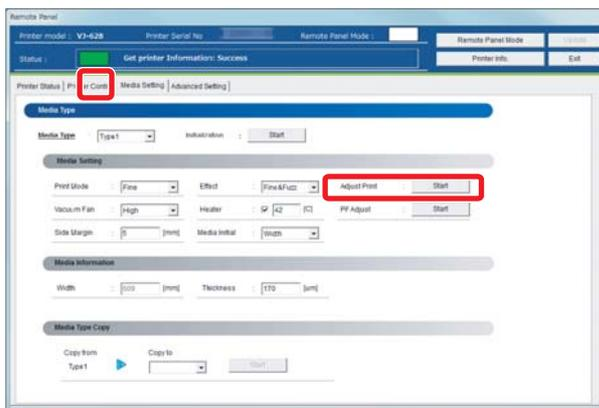

- [5] Enter [Thickness] ([μm]) in [1. Media thickness], and click [Setting].
- Enter the thickness of a set media.

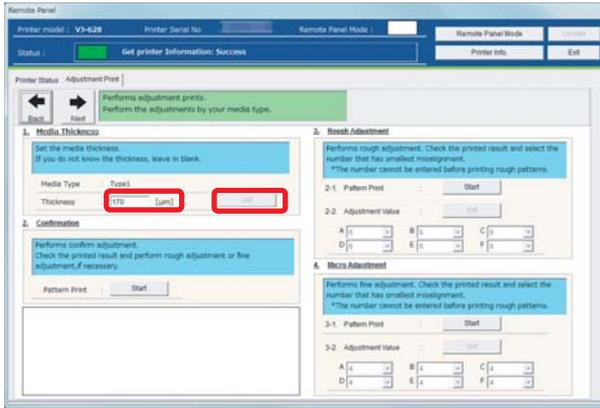

2. Checking picture quality

- [1] Click [Start] in [2. Confirmation].
- Patterns are printed.

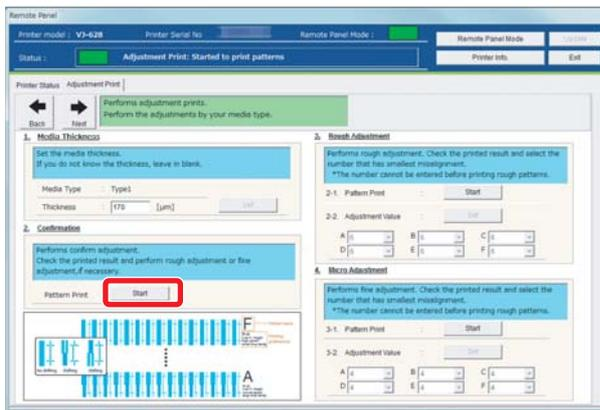

- [2] Check from Pattern A to Pattern F, and if there are shifting problems, proceed to "Rough adjustment" on page 20.
- In the example below, there are shifting problems in Pattern A.

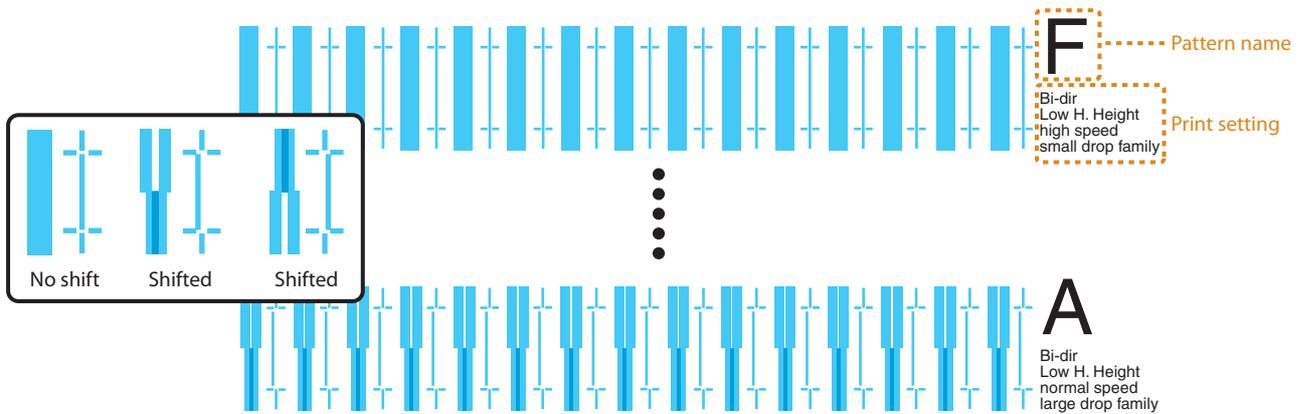

Note

The example is 4 colors setting. In case of 6 colors setting, the pattern color becomes magenta (red type color). The pattern color of rough adjustment and micro adjustment is the same.

3. Rough adjustment

[1] Click [Start] in [3-1 Pattern Print] of [3. Rough Adjustment].

- Patterns are printed.

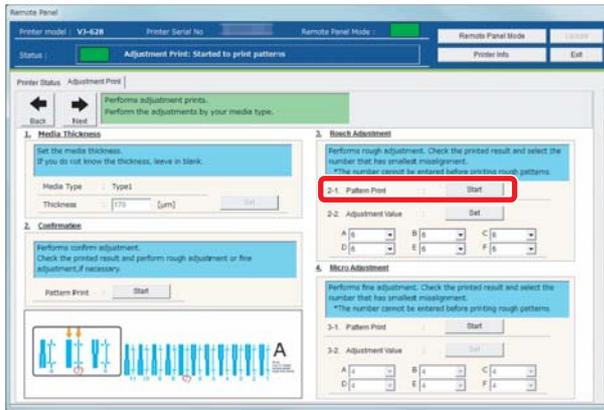

[2] Look for and mark a number printed under a pattern that has least shifting in Pattern A.

- The same pattern (A to F) is printed repeatedly in the center and both edges of media.

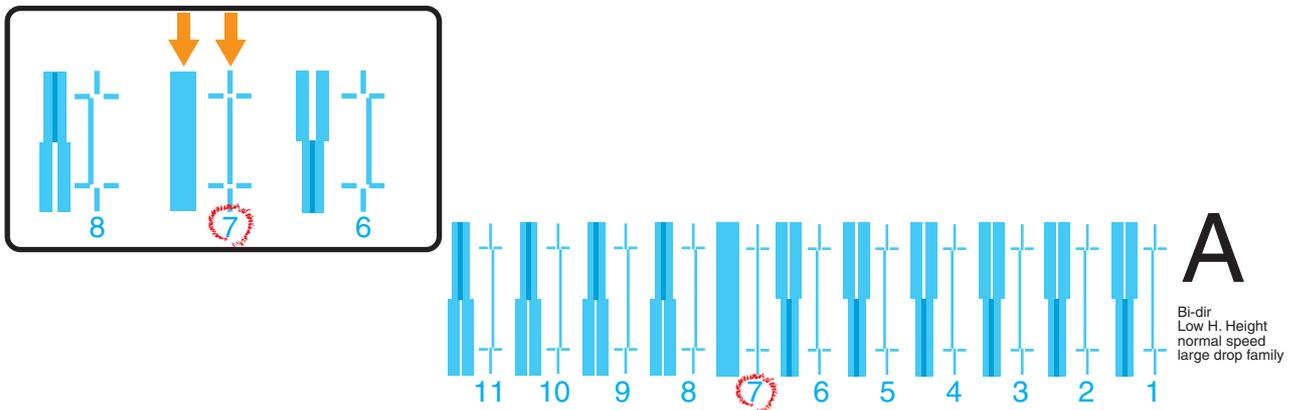

Note

Even in the same pattern, the number that has no shifting may be different between the center and both edges of media. In such a case, look for a number that has the least shifting in average.

[3] Mark a number likewise from Pattern B to Pattern F.

[4] Enter marked values in A to F of [2-2 Adjust Change] in [3. Rough Adjustment], and click [Setting].

- Proceed to "Micro adjustment" on page 21.

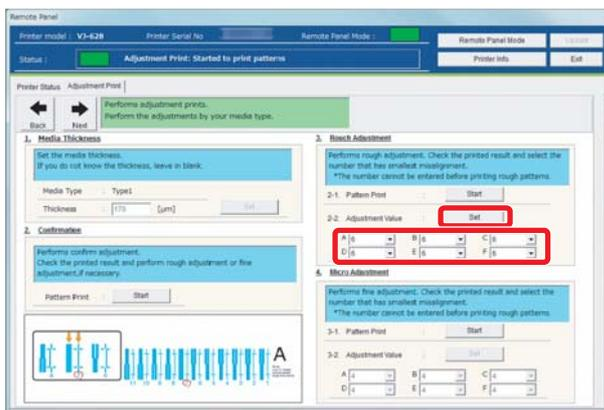

4. Micro adjustment

- [1] Click [Start] in [4-1 Pattern Print] of [4. Micro Adjustment].
- Pattern A to Pattern F are printed.

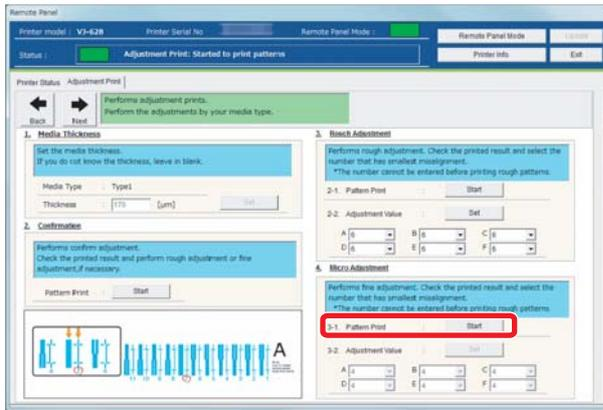

- [2] Similar to "2. Rough adjustment", mark a number printed under the pattern that has the least shifting.
- Mark on Pattern A to Pattern F.

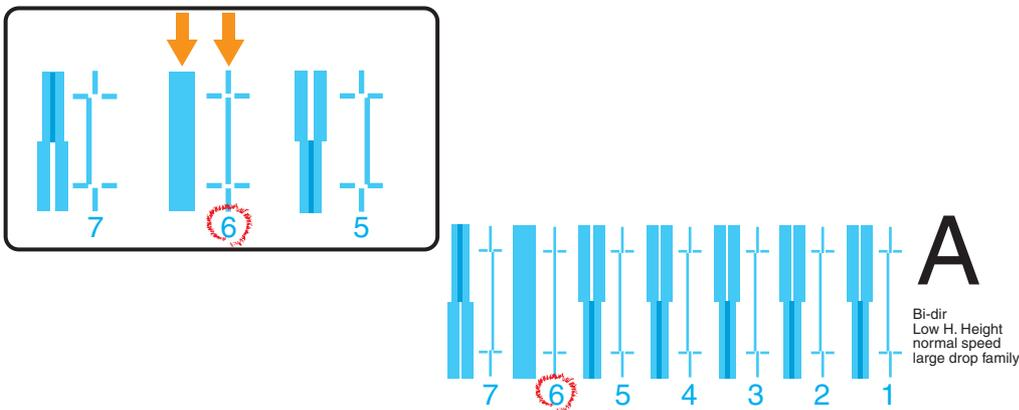

- [3] Enter marked values in A to F of [4-2 Adjust Change] in [4. Micro Adjustment], and click [Setting].
- This completes the picture quality adjustment.

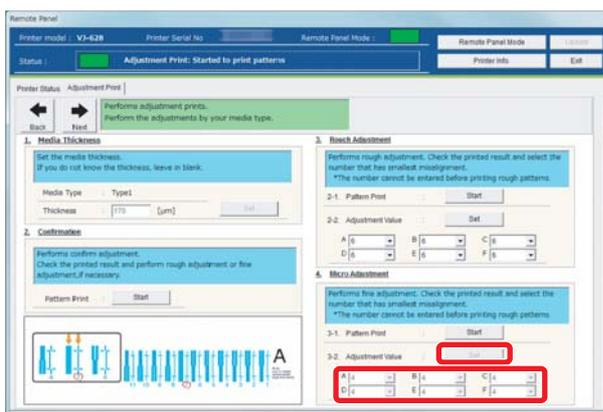

Correcting paper feed

For the following cases, please conduct this adjustment.

- Using this product for the first time.
- Changing a media type.

For any other cases, please proceed to ["Nozzle check and cleaning" on page 27](#).

A ruler is used for this adjustment. Please prepare a commercially available ruler.

Note

When the following defects are found in printing results, they may improve by conducting a paper feed correction.

- Images are overlapping.
- There are white lines in images.

Paper feed correction steps

1. Initial adjustment

[1] Display the Printing Preferences screen of printer driver.

 ["Displaying the Printing Preferences screen of printer driver" on page 8](#)

[2]

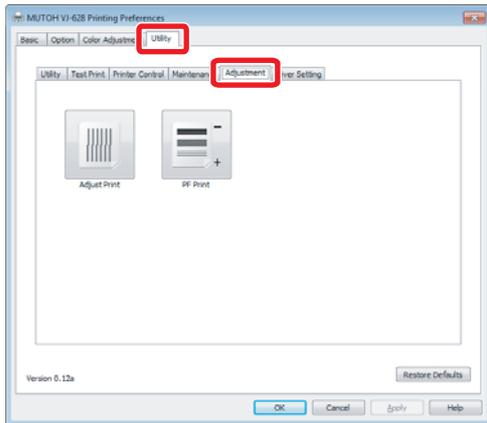

Click the [Adjustment] tab under the [Utility] tab.

[3]

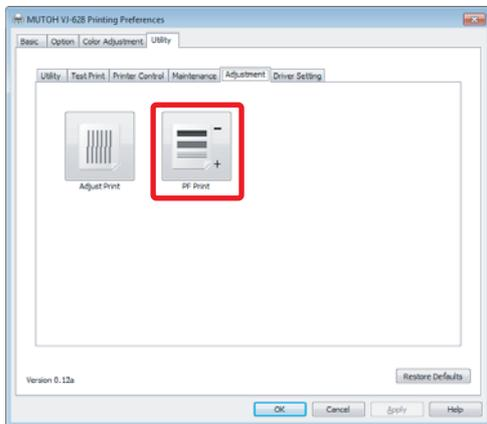

Click [PF Print].

- The remote panel of VSM launches.

Note

VSM can be launched directly.

 ["Launching VSM" on page 9](#)

- [4] Click [Start] in [PF Adjust] of the [Media Setting] tab.
- The [PF Adjust] window opens.

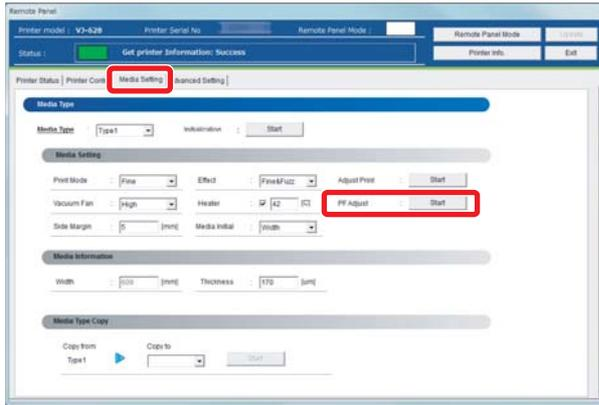

- [5] Select the length ([mm]) of [1-1 Pattern Print] in [1. Initial Adjust], and click [Start].
- Select a length that can be measured with a prepared ruler. When a pattern is longer, a precision level improves.
 - A pattern is printed.

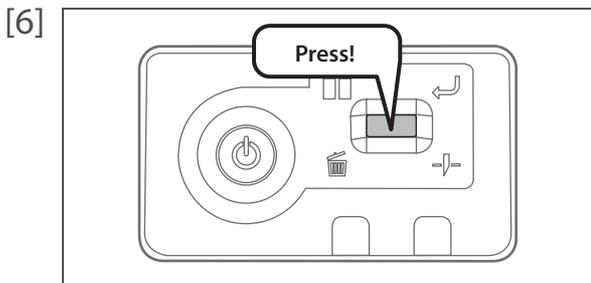
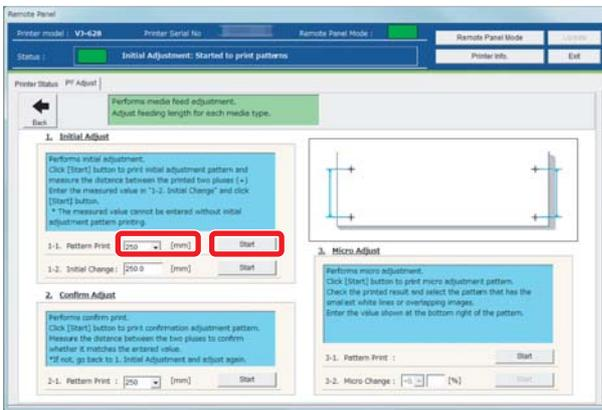

- Cut the media.
- Press and hold the operation key on the operation panel for 2 seconds or more.
 - The built-in cutter in this product cuts the media.

- [7] With a ruler, measure the length between "+" in the pattern.
- In the example below, the measured place is shown in blue dotted lines and arrows (the blue parts are not actually printed).

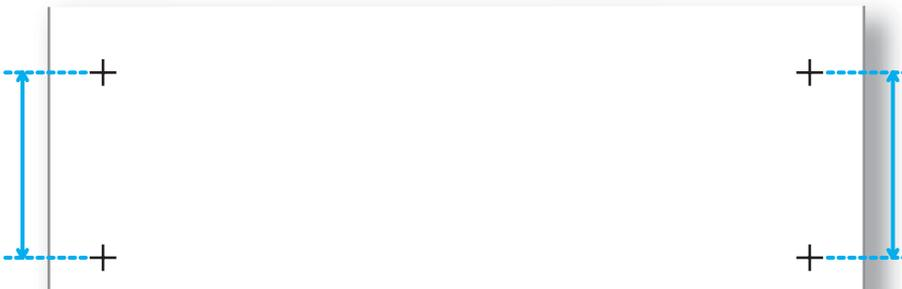

[8] Enter a measured length to the length ([mm]) of [1-2. Initial Change], and click [Start].

- The initial change value is saved.
- Please proceed to "[Confirming adjustment](#)" on page 24.

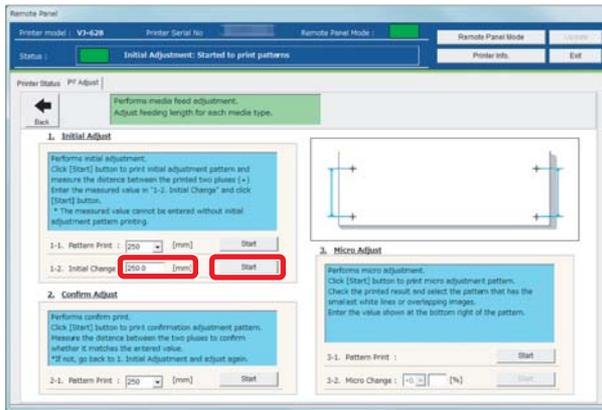

2. Confirming adjustment

[1] In [2. Confirm Adjust], select a length ([mm]) of [2-1. Pattern Print] from the dropdown menu, and click [Start].

- A pattern is printed.

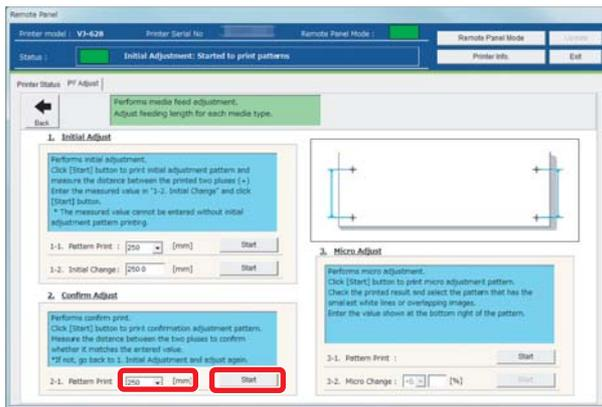

[2]

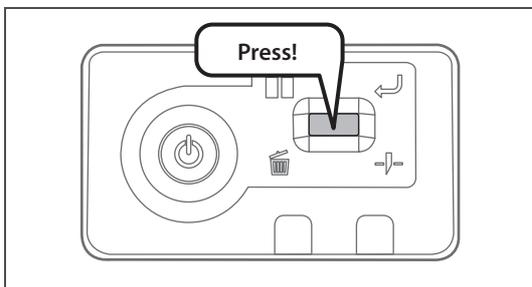

Cut the media.

- Press and hold the operation key on the operation panel for 2 seconds or more.
- The built-in cutter in this product cuts the media.

[3] Using a ruler, measure the length between "+" in the pattern.

- In the example below, the measured place is shown in blue dotted lines and arrows (the blue parts are not actually printed).

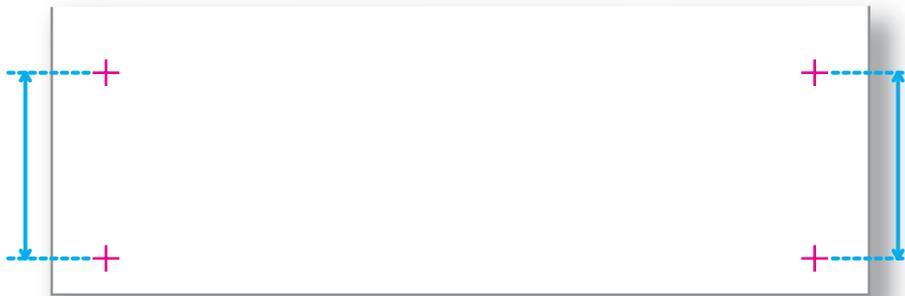

[4] Confirm the measured length.

- If the measured length matches the length selected in Step 1, proceed to "Micro adjustment" on page 21.
- If the measured length does not match the selected length, re-correct with "Checking picture quality" on page 19.

3. Micro adjustment

[1] Click [Start] in [3-1. Pattern Print] of [3. Micro Adjust].

- A pattern is printed.

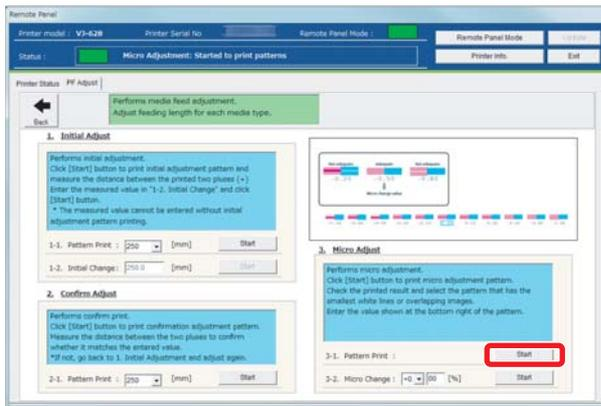

[2] Observe the pattern and verify the micro change value.

- In the pattern, look for a place that has least white lines or overlapping in images.
- The number printed below the pattern is the micro change value.

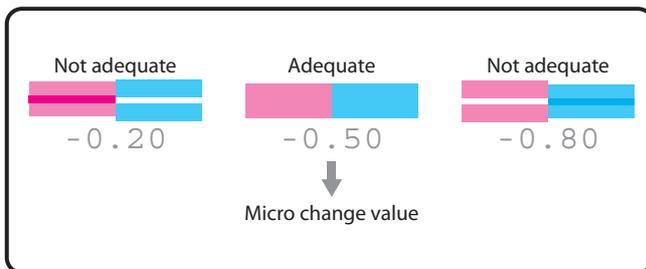

[3] Enter the checked value in Step 2 to [3-2. Micro Change], and click [Start].

- The micro change value is saved.
- This completes the paper feed correction.

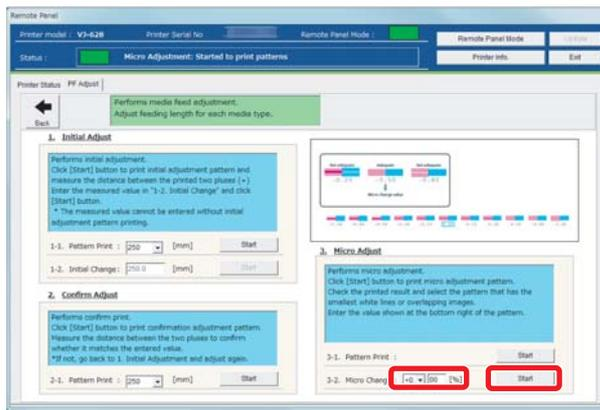

 Note

The micro change value saved in Step 3 becomes the pattern's standard value.

For example, if “-0.50” is saved as the micro change value and a pattern is printed again, the number below the center pattern changes from “0.00” to “-0.50”, and the left edge to “+0.70” and right edge to “-1.70”.

Nozzle check and cleaning

Before starting everyday operation, please check the nozzle. If nozzle clog is found, conduct cleaning.

1. Nozzle check steps

- [1] Display the Printing Preferences screen of printer driver.
☞ ["Displaying the Printing Preferences screen of printer driver" on page 8](#)

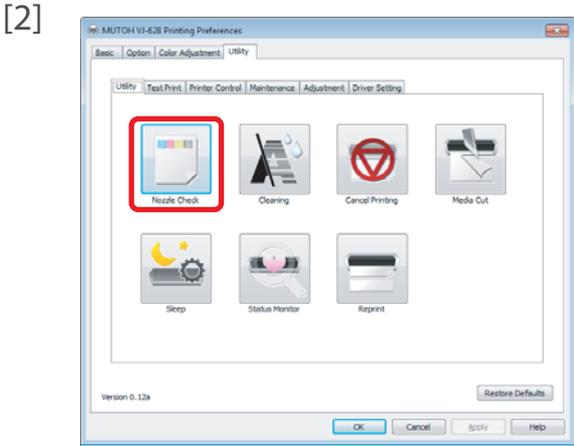

- Click [Nozzle Check] in the [Utility] tab under the [Utility] tab.
- The "MUTOH VJ-628" window opens.

 **Note**

The same can be also done with the remote panel of VSM.

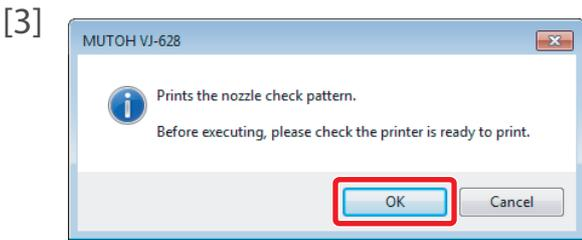

- Click [OK].
- A pattern is printed.

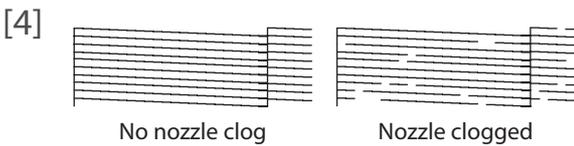

- Check the pattern.
- When there is nozzle clog, proceed to ["Cleaning steps" on page 28](#).
- When there is no nozzle clog, proceed to ["Starting printing" on page 29](#).

2. Cleaning steps

[1]

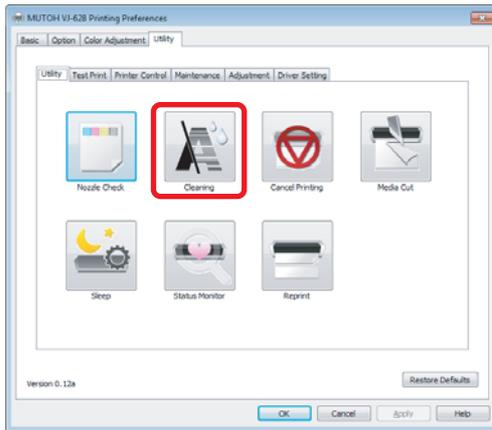

Click [Cleaning] in the [Utility] tab under the [Utility] tab.

- The [Head Cleaning] window opens.



Note

The same can be also done with the remote panel of VSM.

[2]

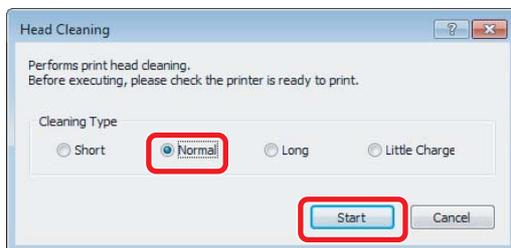

Select [Normal] and click [Start].

- A cleaning starts.

[3] Conduct a nozzle check, again.

👉 ["Nozzle check steps" on page 27](#)

- If there is still nozzle clog, repeat [Normal] cleaning. Refer to ["Head cleaning" on page 51](#) for [Short], [Long] and [Little Charge].

Starting printing

In this section, a method to print from the printer driver is explained.

- [1] Open printing data from application software to execute printing.
- [2] Open the print setup screen of the VJ-628 printer driver from the application software.

- [3] Conduct print setup.
 - Set [Paper Size], [Orientation] and [Print Quality].

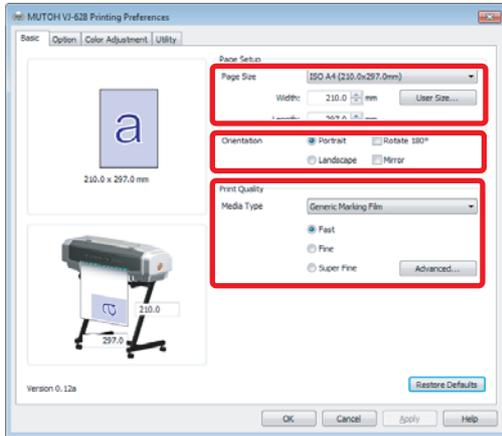

- [4] Click [OK].

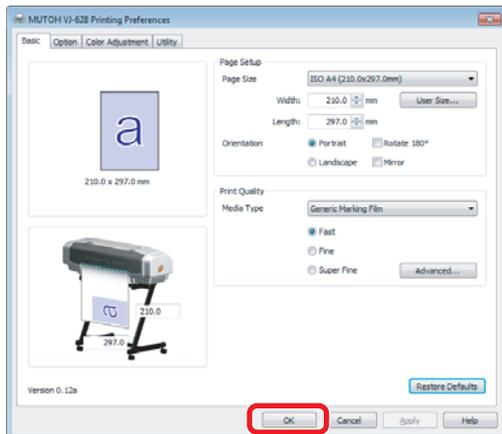

- [5] Printing is executed.

- [6] Cut the media.
 ["Cutting media" on page 32](#)

Pausing/Restarting printing

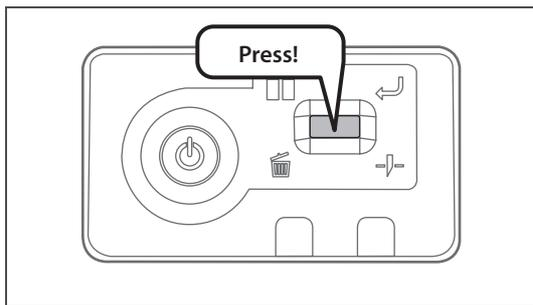

During printing, short press the operation key on the operation panel.

- The printing pauses.
- Press the operation key again to restart the printing.

Note

- In this operation, printing data sent to the product are not deleted.
- Please see the followings when canceling printing and deleting data.
☞ ["Canceling printing" on page 30](#)

Canceling printing

Canceling printing from the operation panel

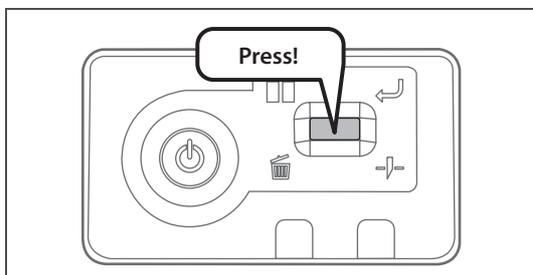

Press and hold the operation key on the operation panel for 2 seconds or more during printing.

- The printing is canceled (it cannot be restarted).
- The printing data sent to the product are deleted.

Canceling printing from printer driver/VSM

- [1] Display the Printing Preferences screen of printer driver during printing.
☞ ["Displaying the Printing Preferences screen of printer driver" on page 8](#)

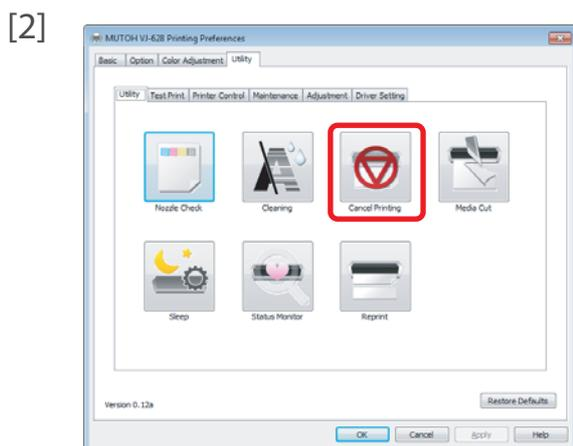

Click [Cancel Printing] in the [Utility] tab under the [Utility] tab.

- The remote panel of VSM launches.
- The [Confirmation] window opens.

Note

- VSM can be launched directly.
☞ ["Launching VSM" on page 9](#)

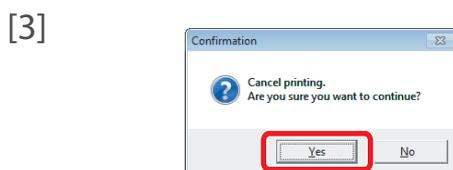

Click [Yes].

- The printing is canceled.

Forwarding/Rewinding media

Forwarding/rewinding media from printer driver/VSM

[1] Display the Printing Preferences screen of printer driver.

 ["Displaying the Printing Preferences screen of printer driver" on page 8](#)

[2]

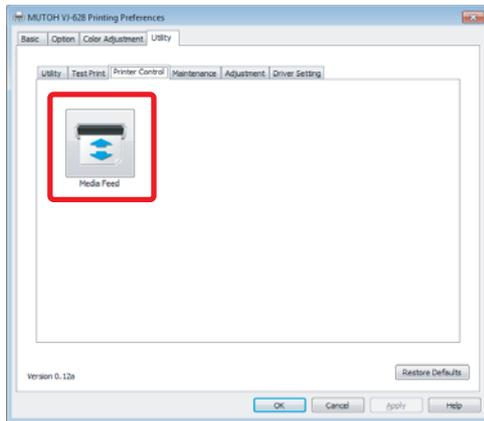

Click [Media Feed] in the [Printer Control] under the [Utility] tab.

- The remote panel of VSM launches.



Note

VSM can be launched directly.

 ["Launching VSM" on page 9](#)

[3] Enter [Feed Amount].

- The unit of [Feed Amount] can be selected from [mm] and [inch].
- The media is forwarded/rewound by the entered length in the [Feed Amount].

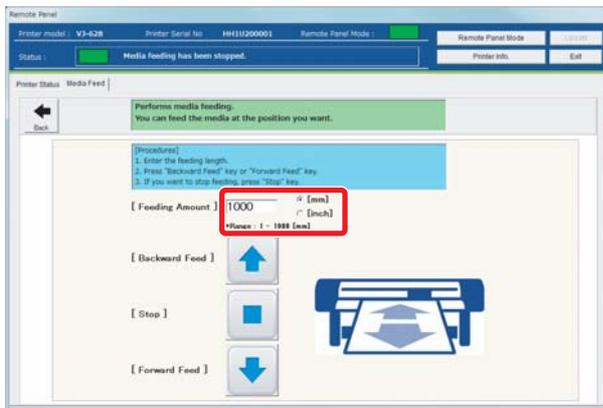

[4] When [Forward Feed]/ [Backward Feed] is clicked, the media is forwarded/rewound.

- Click [Stop] during forwarding/rewinding to stop the operation.
- Or short press the operation key on the operation panel to stop the operation.

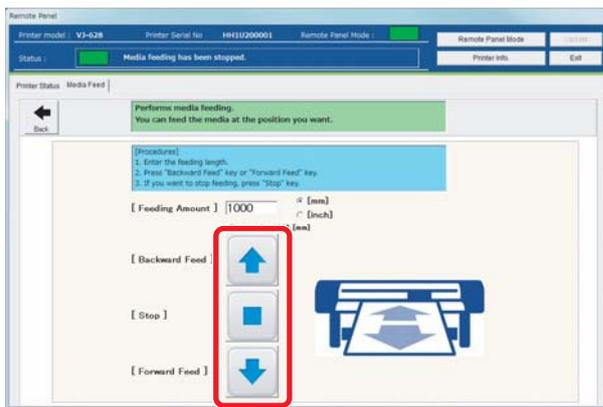

Cutting media

Cutting from the operation panel

[1] Check printing is done.

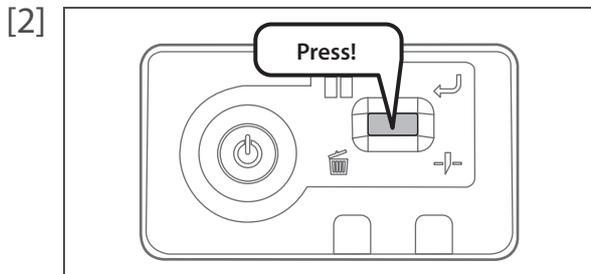

Press and hold the operation key on the operation panel for 2 seconds or more.

- The built-in cutter in the product cuts the media.

Cutting from printer driver/VSM

[1] Check printing is done.

[2] Display the Printing Preferences screen of printer driver.

 ["Displaying the Printing Preferences screen of printer driver" on page 8](#)

[3]

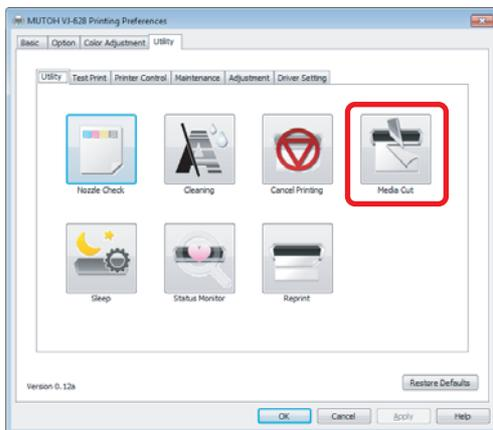

Click [Media Cut] in the [Utility] tab under the [Utility] tab.

- The remote panel of VSM launches.
- The [Confirmation] window opens.



Note

- VSM can be launched directly.

 ["Launching VSM" on page 9](#)

[4]

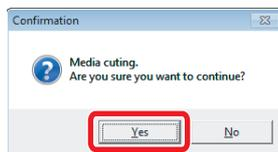

Click [Yes].

- The built-in cutter in the product cuts the media.

Cutting by hand

For media that cannot be cut with the built-in cutter in the product, please cut following the next steps.

[1] Check printing is done.

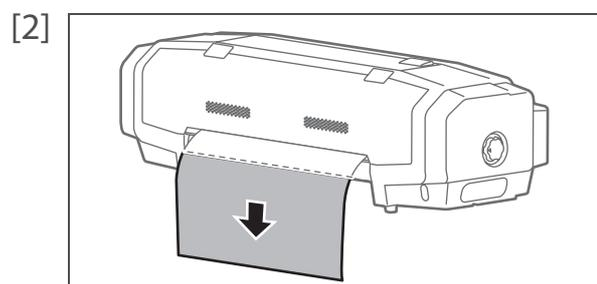

Feed the media to a position where printing results can be cut.
☞ ["Forwarding/Rewinding media" on page 31](#)

[3] Open the front cover, and cut the media with a commercial available cutter.

- Cut along the media cut groove.

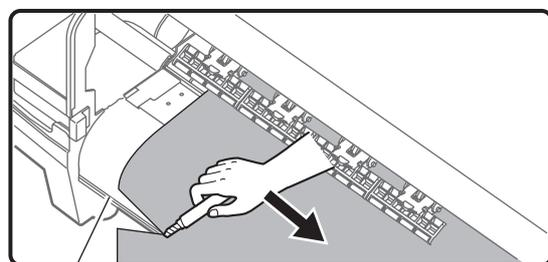

Media cut groove

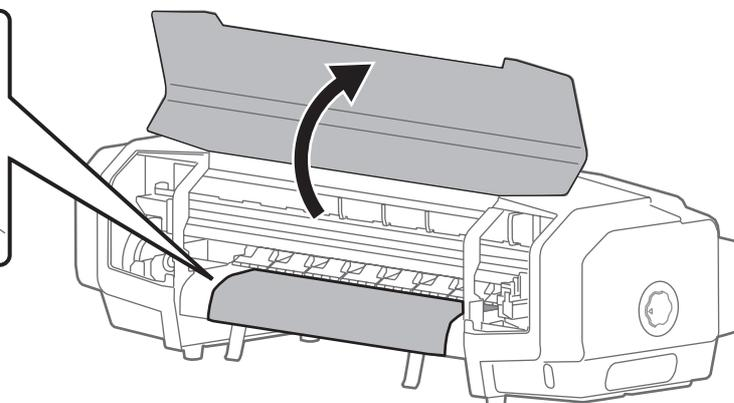

[4] Close the front cover.

Cutting automatically

In this product, a setup is possible to cut media automatically after printing is done. Refer to the setup methods described below.

 ["Setting auto cut" on page 38](#)

Chapter 2 Advanced Operations

Changing head height	36
Releasing pressure arms individually	37
Advanced settings	38
Setting auto cut	38
Setting the vacuum fan	40
Setting the heater	41

Changing head height

If media is lifted or when printing that use a large amount of ink is conducted, the media rubs against the print head and becomes dirty. In such a case, it may improve by setting the print head height high.

When the print head height is changed, always conduct image quality adjustment.

Note

- If media is lifted, the lifted part contacts the bottom part of the print head causing the media to become dirty.
- If media containing a lot of ink becomes sodden and lifted, it contacts the bottom part of the print head causing the media to become dirty.

Steps

[1] Open the front cover.

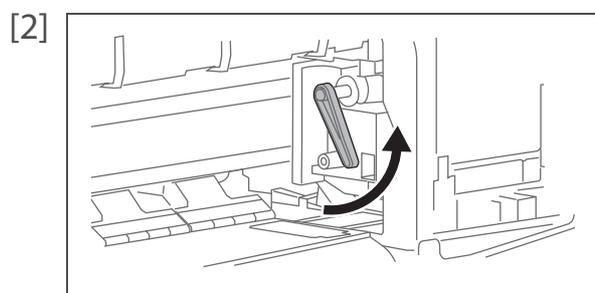

Lift the lever and raise the head height.

[3] Close the front cover.

[4] Conduct image quality adjustment.

 [Adjusting image quality](#)

Important!

Do not change the print head height while printing.

Releasing pressure arms individually

When printing on thin media or media without stiffness, the media rubs against the print head and becomes dirty. In such a case, it may improve when releasing the pressure arms holding both sides of media.

When releasing the pressure arms individually, always conduct paper feed correction.

Note

- Thin media or media without stiffness is likely to be wrinkled during printing. Wrinkles can contact the bottom side of the print head causing the media to become dirty. When both edges of the pressure arms of media are released, it can prevent wrinkles.
- When printing on thin media or media without stiffness, wrinkles can be prevented by turning down the vacuum fan.
👉 ["Setting the vacuum fan" on page 40](#)

Steps

[1] Open the front cover.

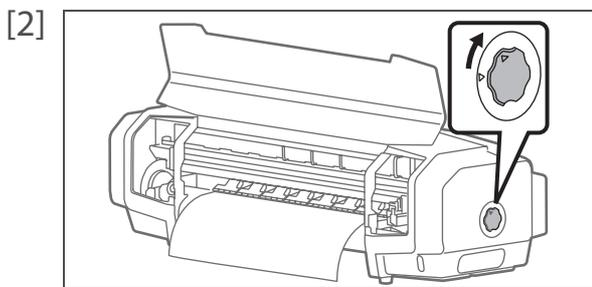

Turn the media fixing knob to release the lock.

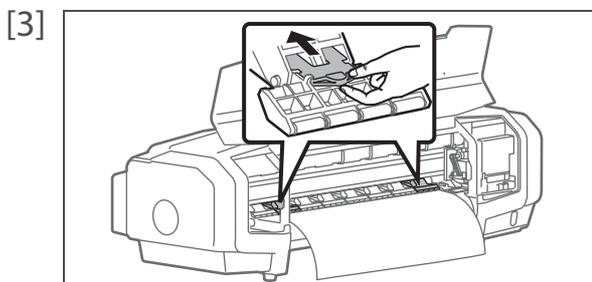

Release the pressure arms on both edges of media.

- Push in the release switch to release.

[4] Conduct paper feed correction.

👉 ["Correcting paper feed" on page 22](#)

Note

- If media still remains dirty, it may improve by increasing the number of pressure arms to release. In such a case, release the same number of pressure arms for right and left each.

[5] Close the front cover.

Advanced settings

Settings in this product can be changed to match your usage.

Only a part of functions is introduced here.

For usage functions of software, please refer to help or manual of software.

 ["Displaying Help or Manual" on page 11](#)

Setting auto cut

It can be set to cut media automatically, when printing is done.

Setup is done to match the width, thickness and material of media.



Note

Depending on media, cutting cannot be done. In such a case, cut manually.

Steps

- [1] Launch the remote panel of VSM.

 ["Displaying remote panel" on page 9](#)

- [2] Select anything but [Off] in the [Media Initial] menu under the [Media Setting] tab.

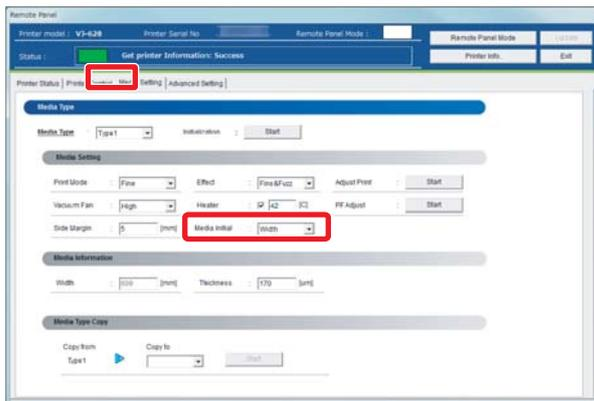

- [3] Select [Auto Cut] in the [Output Mode] menu under the [Advanced Setting] tab.

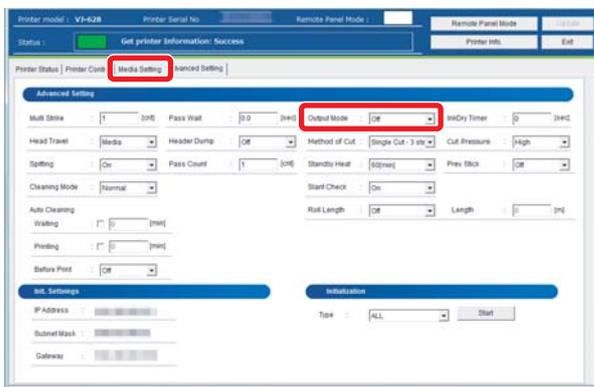

[4] Select a cut method from the [Method of Cut] menu.

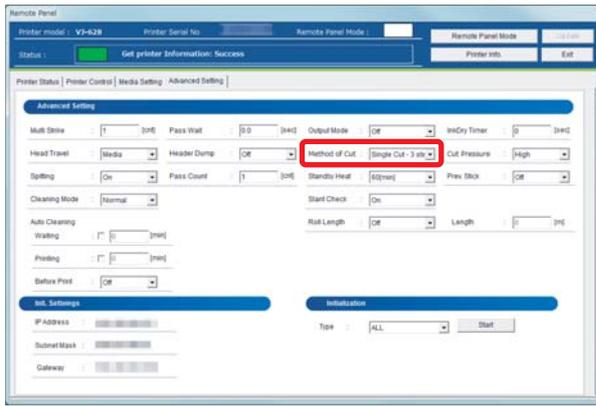

There are following modes in the [Method of Cut] menu.

Single Cut - 2 steps	Cut with fewer steps than “Single Cut - 3 steps”. Suitable for media with narrow width.
Single Cut - 3 steps	By default, this cut method is used.
Double Cut - 2 steps	Set when unable to cut with “Single Cut - 2 steps”. Suitable for media with narrow width.
Double Cut - 3 steps	Set when unable to cut with “Single Cut - 3 steps”.

[5] Select [High] or [Low] for cut strength in the [Cut Pressure] menu.

- [Low] is used for thin media.

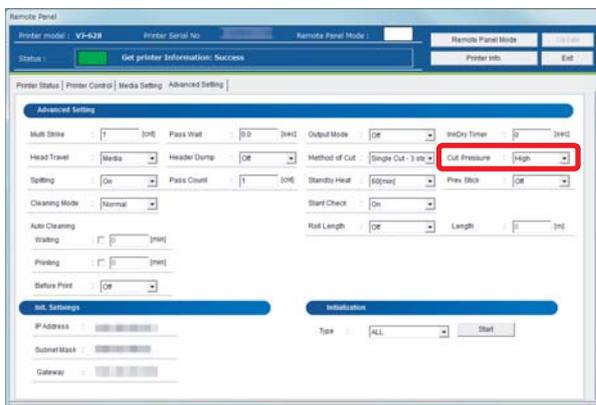

[6] Click [Update].

- The setting is reflected on the product.

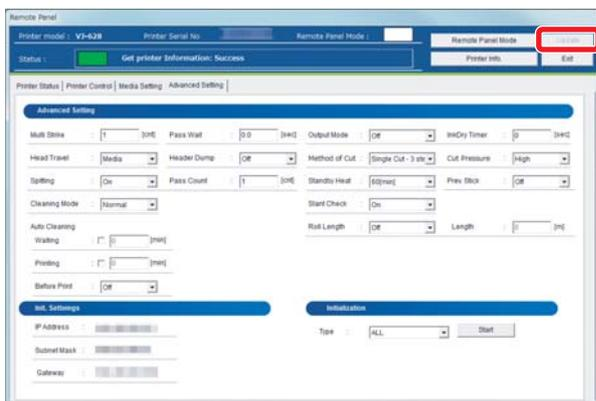

Setting the vacuum fan

When printing on thin media or media without stiffness, it can prevent wrinkles or media jamming, if the vacuum fan is set to Low.

Steps

[1] Display the Printing Preferences screen of printer driver.
☞ "Displaying the Printing Preferences screen of printer driver" on page 8

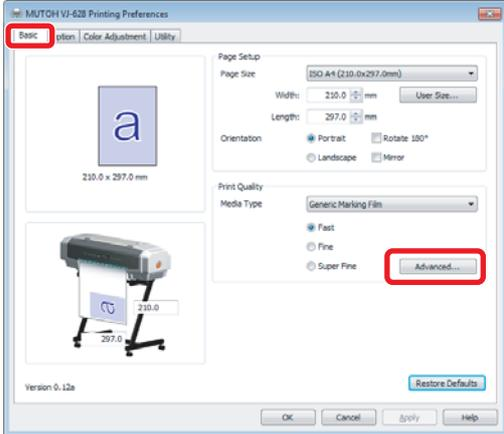
[2]  Click [Advanced...] in the [Basic] tab.

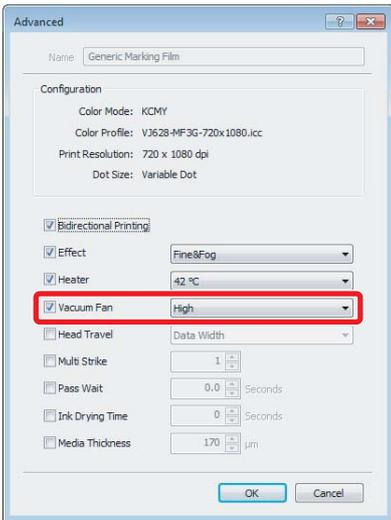
[3]  From the [Vacuum Fan] menu, select [Middle] or [Low].

 **Note**

- If the checkmark is removed from the checkbox, the setting already registered in the printer's main body has priority.
- The same can be also done with the remote panel of VSM. Set in the [Vacuum Fan] menu of the [Advanced] tab.

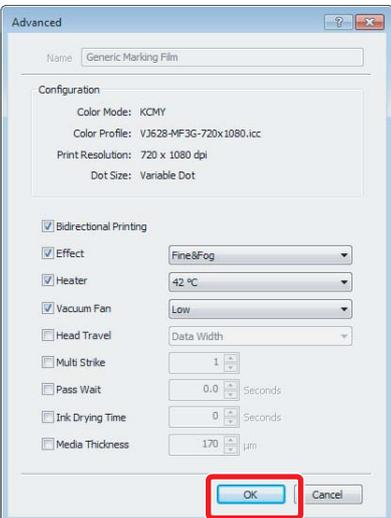
[4]  Click [OK].

- The setting is reflected in this product.

Setting the heater

Functions of the heater are to warm up media before and after printing to improve print quality and promote fast drying. If the heater setting is changed matching the thickness or material of media, better results can be obtained.

Steps

[1] Display the Printing Preferences screen of printer driver.

 "Displaying the Printing Preferences screen of printer driver" on page 8

[2]

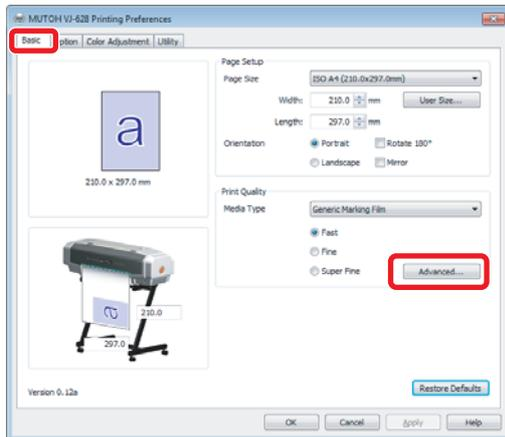

Click the [Advanced...] in the [Basic] tab.

[3]

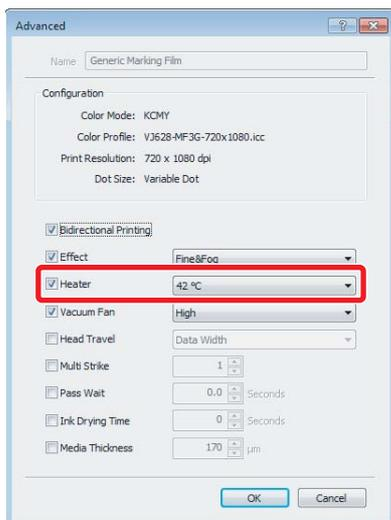

In [Heater] menu of the [Advanced] tab, enter a temperature.

- It can be set to OFF, or between 30 °C and 45 °C.
- Since the most suitable temperature differs depending on media, conduct test print.

Note

- If the checkmark is removed from the checkbox, the setting already registered in the printer's main body has priority.
- The same can be also done with the remote panel of VSM. Set in the [Heater] menu of the [Advanced] tab.

[4]

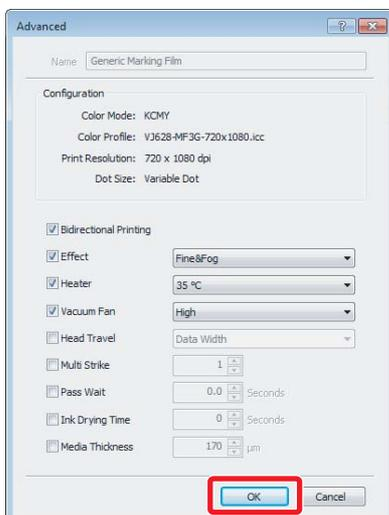

Click [OK].

- The setting is reflected in this product.

Chapter 3 Maintenance

Maintenance	44
Checking ink and replacing ink cartridge	45
Checking ink level.....	45
When it becomes time to replace ink cartridge	46
Replacing ink cartridge	47
Emptying waste ink tank	49
Cleaning each part	51
Head cleaning.....	51
Cleaning of cleaning wiper	53
Cleaning of print head circumference	55
Inside cleaning.....	57
Replacing consumable parts	58
Replacing absorption material for the flushing box	58
Replacing cutter.....	61
Transporting and long-term storage	62
Transporting	62
Initial charging.....	67
Storing for a long time.....	70

Maintenance

To maintain the performance of this product, please conduct maintenance by yourself.
The types of maintenance are shown next.

Before and after daily operation	"Nozzle check and cleaning" on page 27
Based on your usage condition	"Head cleaning" on page 51
	"Replacing ink cartridge" on page 47
	"Emptying waste ink tank" on page 49
	"Replacing absorption material for the flushing box" on page 58
Weekly	"Replacing cutter" on page 61
	"Cleaning of cleaning wiper" on page 53
Monthly	"Cleaning of print head circumference" on page 55
	"Inside cleaning" on page 57
When not used for a week or more	Weekly "Head cleaning" on page 51

Important!

Since a service technician has to handle following cases, please contact your local MUTOH dealer.

- Emergency mode is happening repeatedly.
- The message to notify the life of print head and various motors is displayed in VSM.

 ["Handling messages/error messages" on page 72](#)

Checking ink and replacing ink cartridge

Checking ink level

[1] Display the Printing Preferences screen of printer driver.

☞ "Displaying the Printing Preferences screen of printer driver" on page 8

[2]

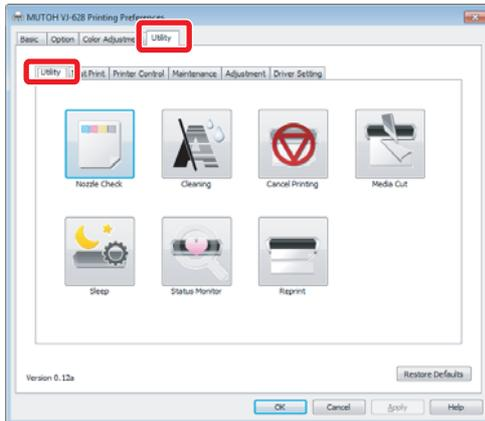

Click the [Utility] tab under the [Utility] tab.

[3]

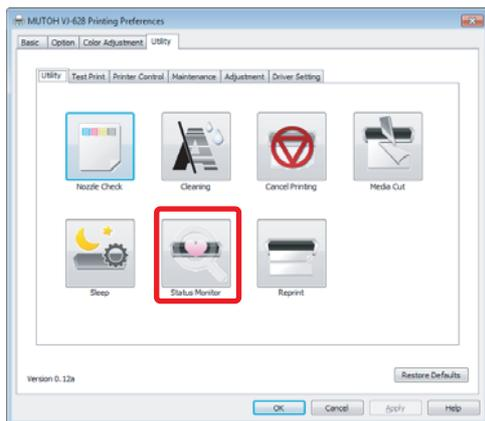

Click [Status Monitor].

- The VSM remote panel opens.



Note

- VSM can be launched directly.

☞ "Launching VSM" on page 9

[4] Check [Ink Information] in the [Printer Status] tab.

- As ink is used, the colored scale becomes low.

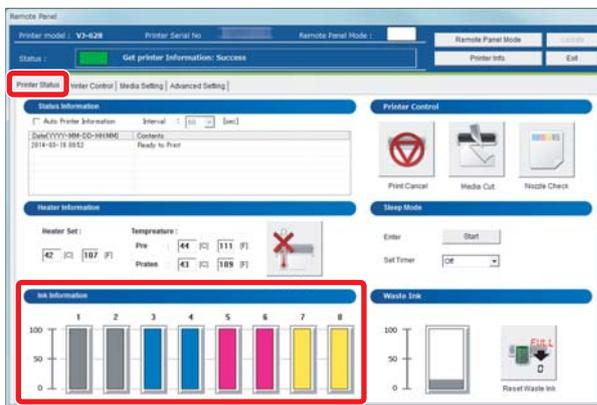

When it becomes time to replace ink cartridge

When the ink level becomes low, the error LED of the operation panel flashes and a buzzer sounds.

Steps

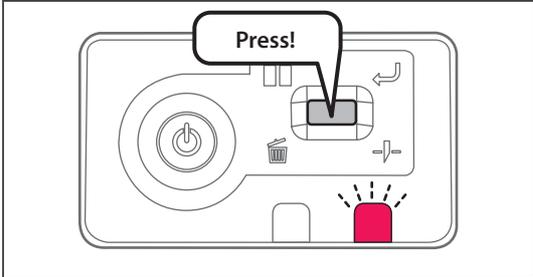
- [1]  Short press the operation key on the operation panel.
- The buzzer stops.

- [2] Check the ink cartridge that needs to be replaced.
 ["Checking ink level" on page 45](#)

- Check [Status Information] also.



- [3] Prepare an ink cartridge to replace.

Replacing ink cartridge

When ink level becomes low, the error LED of the operation panel flashes and a buzzer sounds. Printing pauses temporarily. It restarts after changed with a new ink cartridge.

Steps

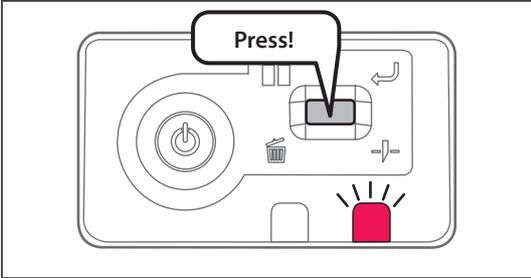
- [1]  Short press the operation key on the operation panel.
- The buzzer stops.

- [2] Check the ink cartridge that needs to be replaced.
 ["Checking ink level" on page 45](#)

- Check [Status Information] also.

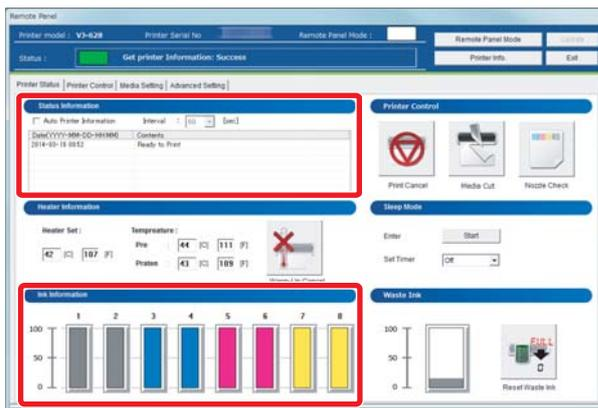

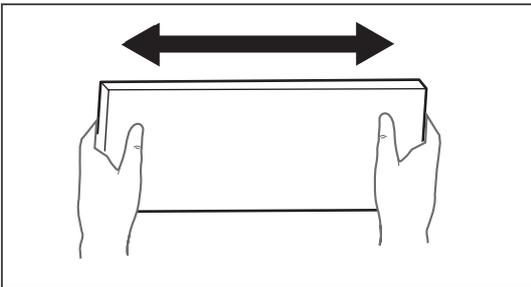
- [3]  Shake the ink cartridge 2 or 3 times lightly.

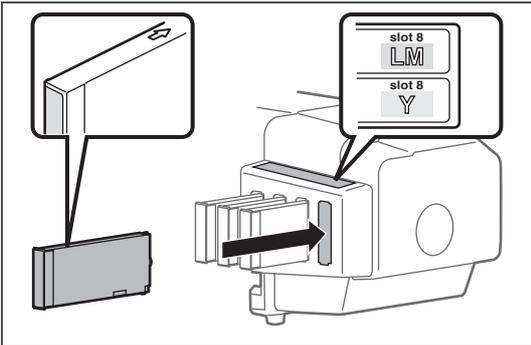
- [4]  Remove the empty ink cartridge and insert the new one.
- Make sure to match the ink cartridge color with the label of this product.
 - The arrow should face up.
 - Insert all the way to the end.

 **Important!**

- Do not replace ink cartridge when the power of this product is OFF.
Ink level cannot be detected correctly.
- If ink cartridge is moved from cold to warm place, leave it at least 3 hours.

 **WARNING**



Leave ink cartridges away from fire or high temperature objects.
It may cause fire.

Emptying waste ink tank

When a certain amount of ink is used, the error LED in the operation panel of this product becomes ON, and a buzzer sounds. Pour waste ink inside the waste ink tank to PET bottle, and discharge.

CAUTION



- Be cautious that ink does not get into your eye or make a contact with your skin. Wear goggles and groves. When ink gets into your eye or make a contact with your skin, wash with water immediately. If left as it is, it may cause red eye or light inflammation. If it is necessary, please see your doctor immediately.

Important!

When moving this product, always empty the waste ink tank even if it is for a short distance. If ink splashes inside the waste ink tank while being moved, it can cause damage.

Steps

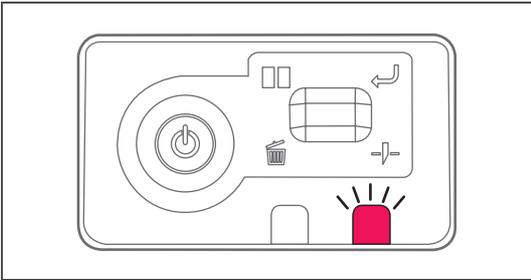
- [1]  Check the error LED is flashing.

- [2] Launch VSM and display the remote panel.
 ["Launching/Displaying/Finishing ValueJet Status Monitor \(VSM\)" on page 9](#)

- [3] Check [Status Information] in the [Printer Status] tab.
• A message indicating that the waste ink tank is full is displayed.

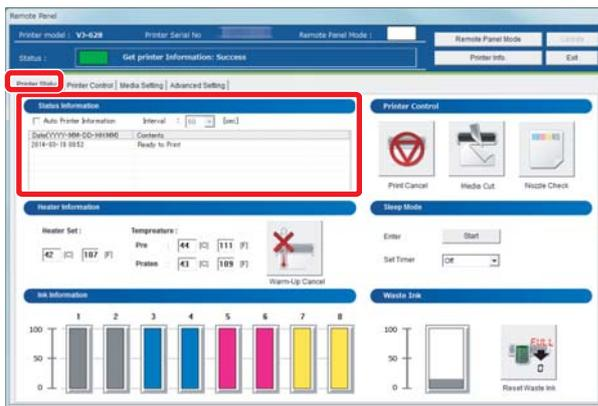

- [4] Prepare a container like PET bottle to transfer the waste ink.

Important!

The capacity of waste ink tank is 1500 ml. Make sure to prepare a container that has enough capacity when discharging waste ink.

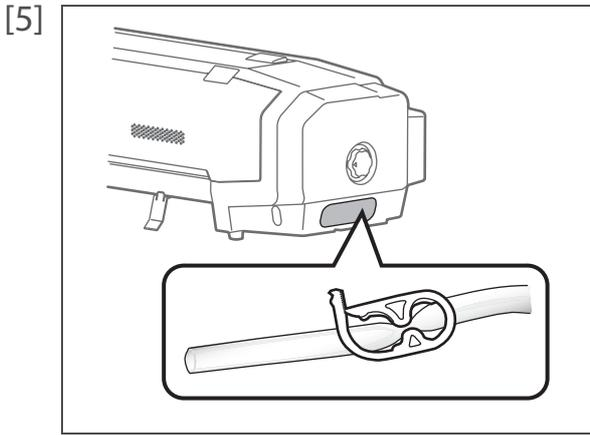

Pull out the tip of the waste ink tube.

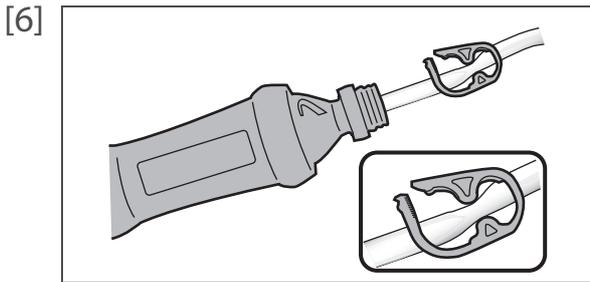

- Insert the waste ink tube into a container.
- Release the tube clip of waste ink.
- Pour waste ink into the container.

WARNING



You are obligated to properly dispose of waste fluid from the printer in compliance with Wastes Disposal and Public Cleansing Act and local ordinances. Delegate disposal to an industrial waste disposal contractor.

[7] Click [Reset Waste Ink].

- The confirmation window opens.

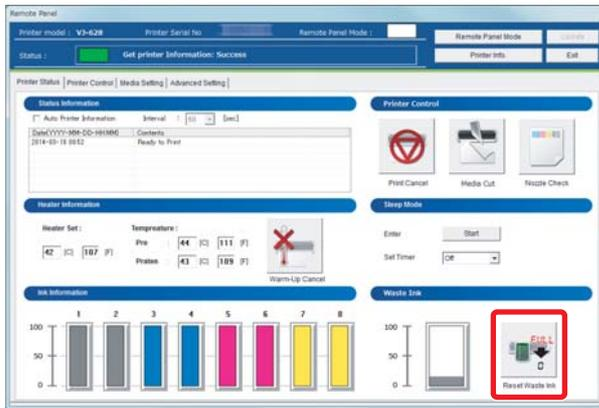

Note

[Reset Waste Ink] can be also done from [Utility] - [Maintenance] of the printer driver.

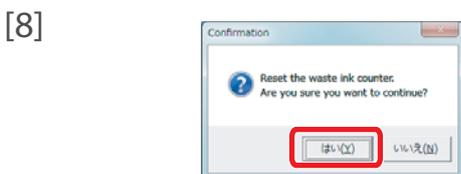

Click [Yes].

- The waste ink counter is set to 0.

Cleaning each part

To use this product always in its best condition, please clean periodically.

Head cleaning

When nozzle clogging is found in nozzle check, conduct head cleaning. Head cleaning consumes ink.

There are several cleaning modes in this product. Please use them accordingly based on your usage condition.

Short cleaning	Consumes less ink than Normal cleaning.
Normal cleaning	Conduct nozzle check before and after printing, and use when nozzle clogging is found.
Long cleaning	Consumes more ink than Normal cleaning. When nozzle clogging still occurs after Normal cleaning, conduct Long cleaning.
Little Charge	Though much better cleaning results can be expected than Long cleaning, it consumes a large amount of ink.

Steps for head cleaning

- [1] Display the Printing Preferences screen of the printer driver.
["Displaying the Printing Preferences screen of printer driver" on page 8](#)

- [2] Click [Cleaning] in the [Utility] tab under the [Utility] tab.
• The "Head Cleaning" window opens.

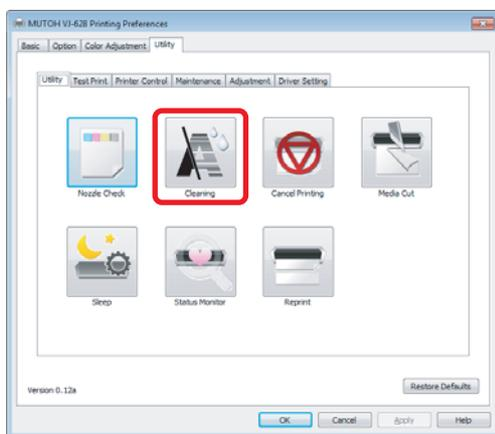

Note

The same can be also done with VSM.

- [3] Select a mode of cleaning and click [Start].
• Cleaning starts.

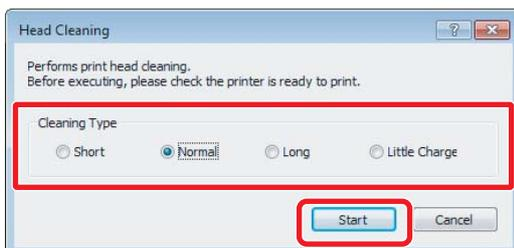

[4] Conduct Nozzle Check.

- If nozzle clogging still remains, repeat cleaning and nozzle check.

 ["Steps for head cleaning" on page 51](#)



Note

- When nozzle clogging remains even after repeating normal cleaning several times, conduct Long cleaning.
- When nozzle clogging remains even after repeating Long cleaning several times, conduct ["Cleaning of cleaning wiper" on page 53](#) or ["Cleaning of print head circumference" on page 55](#).
- Yet, when nozzle clogging remains, conduct "Little Charge".

Cleaning of cleaning wiper

Cleaning period:

- Weekly
- When print blurring and dot missing remain after head cleaning is done.

Preparation:

- Cleaning stick

Steps

[1] Display the Printing Preferences screen of printer driver.

 ["Displaying the Printing Preferences screen of printer driver" on page 8](#)

[2]

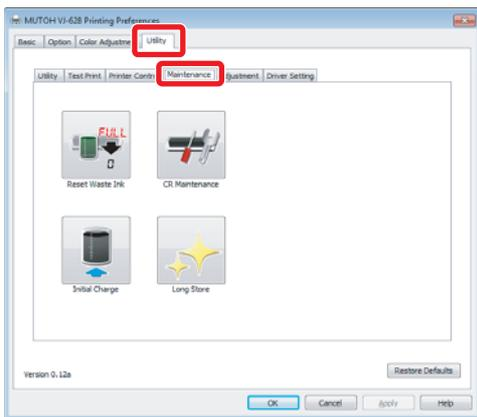

Click the [Utility] tab under the [Maintenance] tab.

[3]

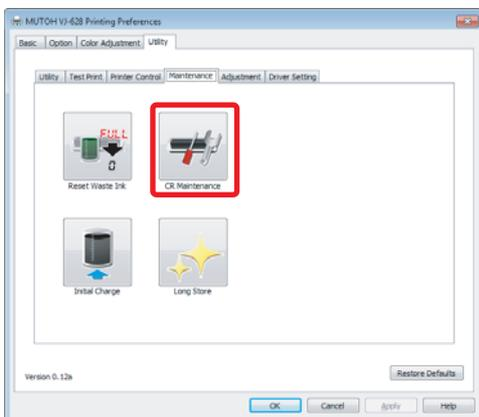

Click [CR Maintenance].

- The VSM remote panel opens.



Note

- VSM can be launched directly.

 ["Launching VSM" on page 9](#)

[4] Click [Start].

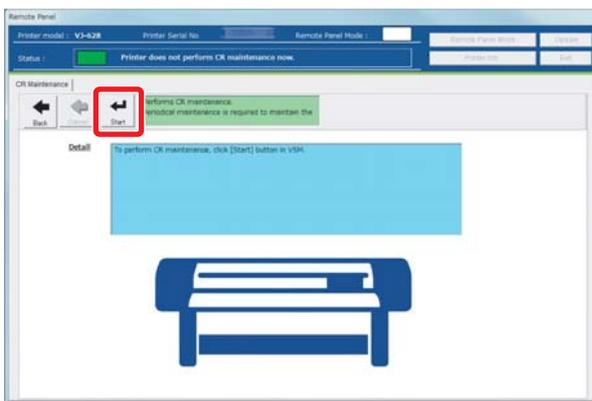

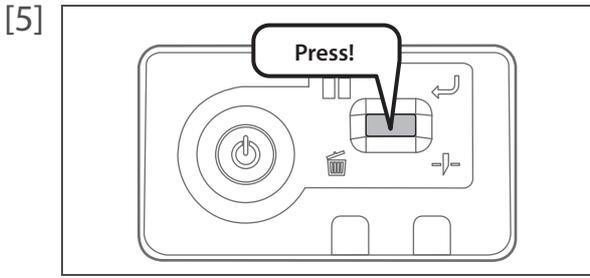

Short press the operation key on the operation panel.

- The carriage moves to the maintenance position inside the front cover.

[6] Open the front cover.

Important!

When cleaning the cleaning wiper, please note the followings.

- Use a cleaning stick in dry condition. If moisten with water or solution, it can cause damage to the print head.
- Do not reuse a cleaning stick. Dusts can adhere causing damage to the print head.
- Standard cleaning time should be within 5 minutes. If it takes longer, the stick can dry causing damage to the print head.

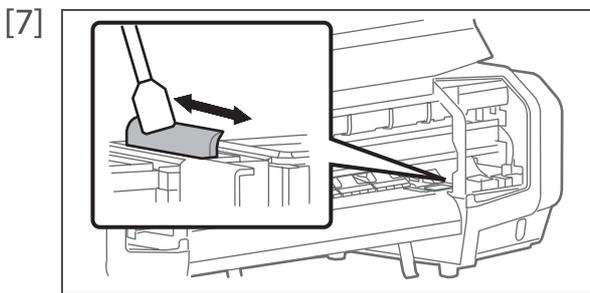

Wipe the cleaning wiper with a cleaning stick.

- Wipe the left side surface of cleaning wiper going back and forth.

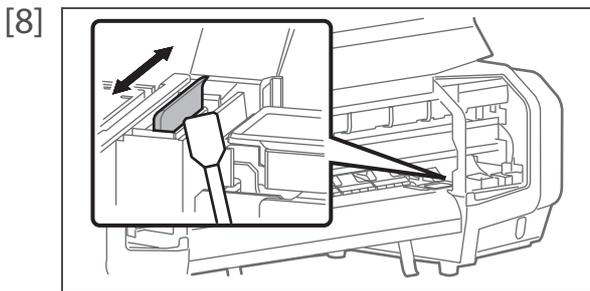

Wipe the right side surface of cleaning wiper going back and forth.

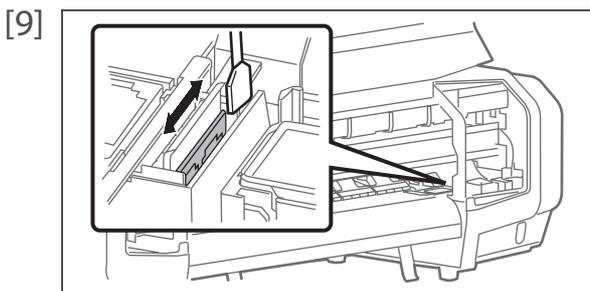

Wipe the right side surface of the base of cleaning wiper going back and forth.

[10] Close the front cover.

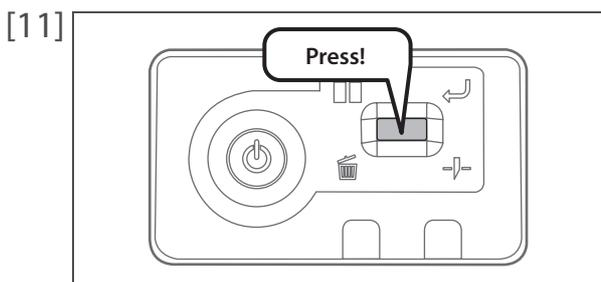

Short press the operation key on the operation panel.

- The carriage moves to the original position inside the front cover.

Cleaning of print head circumference

Cleaning period:

- Weekly
- When print blurring and dot missing remain after head cleaning is done.

Preparation:

Cleaning stick



During cleaning, please note the followings.

- Use a cleaning stick in dry condition. If moisten with water or solution, it can cause damage to the print head.
- Do not touch the tip of a cleaning stick with fingers. If sebum is adhered, it can cause damage to the print head.
- Do not reuse a cleaning stick. Dusts can adhere causing damage to the print head.
- Standard cleaning time should be within 5 minutes. If it takes longer, the stick can dry causing damage to the print head.

Steps

[1] Display the Printing Preferences screen of printer driver.

["Displaying the Printing Preferences screen of printer driver" on page 8](#)

[2]

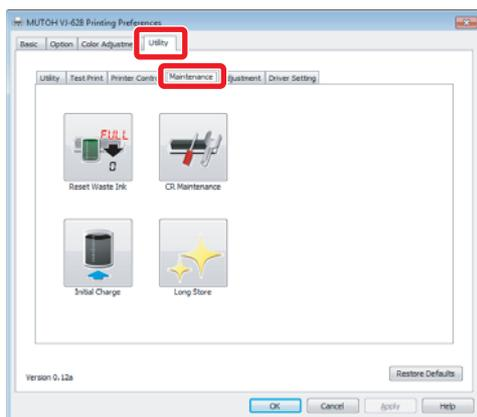

Click the [Maintenance] tab under the [Utility] tab.

[3]

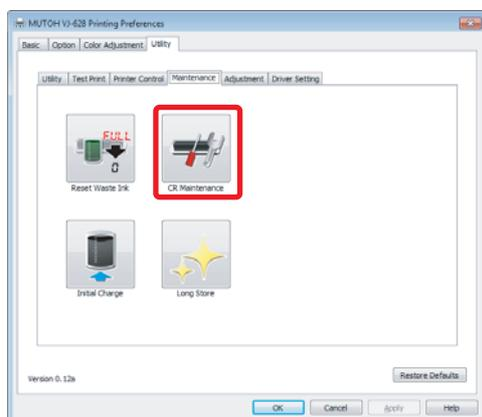

Click [CR Maintenance].

- The VSM remote panel opens.



Note

- VSM can be launched directly.

["Launching VSM" on page 9](#)

[4] Click [Start].

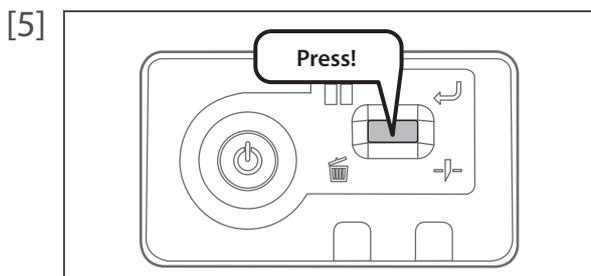
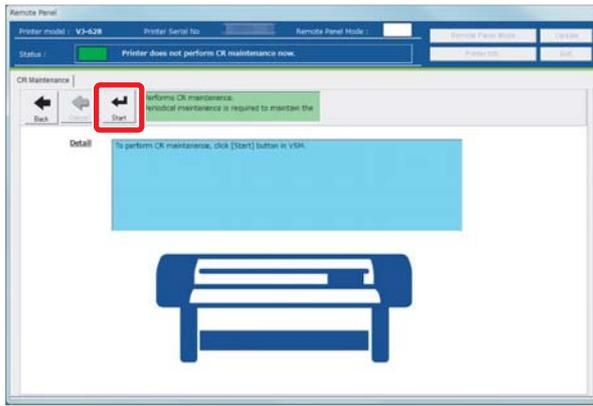

Short press the operation key on the operation panel.

- The carriage moves to the maintenance position inside the front cover.

[6] Open the front cover.

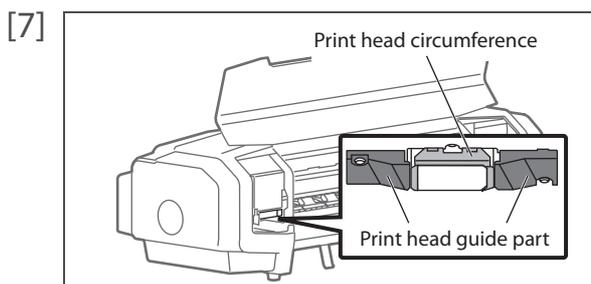

Look at the bottom side of the carriage and check if dusts and ink lump are adhered.

- Print head circumference (silver metal part)
- Print head guide part (black plastic part)

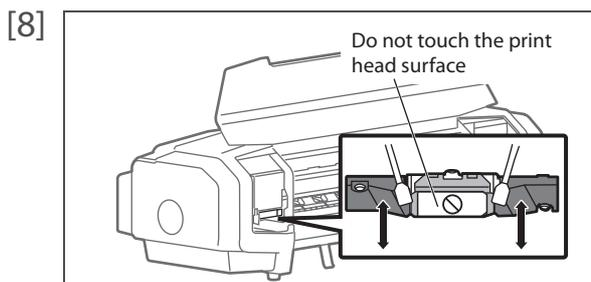

If dusts or ink lump are adhered, clean with a cleaning stick.



- Do not touch the print head surface with fingers or a cleaning stick. It can cause damage to the print head.
- Do not touch the platen or media guide. The temperature may be high.

[9] Close the front cover.

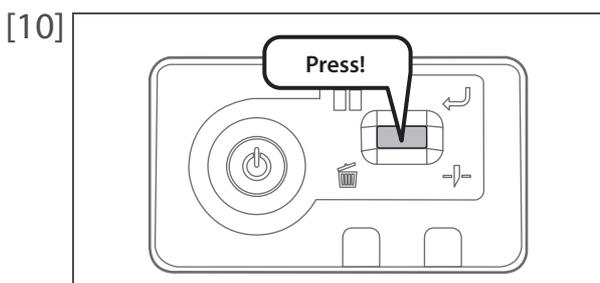

Short press the operation key on the operation panel.

- The carriage returns to the original position inside the front cover.

Inside cleaning

Cleaning period:

- Monthly

Steps

[1] Check the power is OFF.

[2] Open the front cover.

Important!

Immediately after turning off the power, the temperature of the heater in this product is very high. Touch the platen or media guide and if it is too hot, wait for a while before starting cleaning.

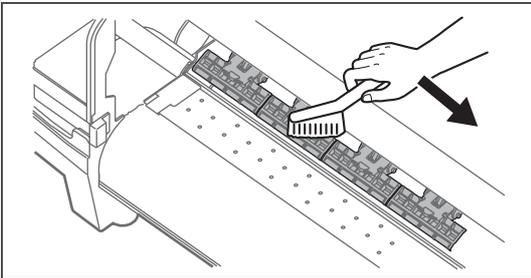
[3]  Brush off dusts on the pressure arms with a soft brush.

Important!

- Do not blow off dusts inside the product with a gas duster. It may cause abnormal noise.

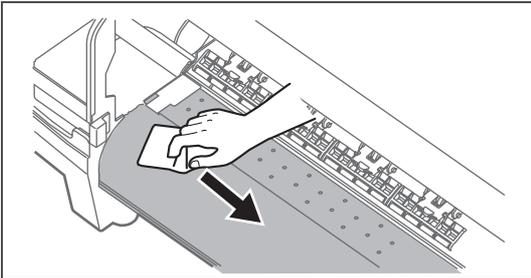
[4]  Using a soft cloth that is soaked in water and squeezed tightly, wipe dirt on the platen and media guide.

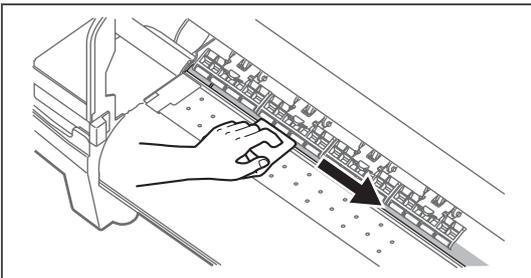
[5]  Using a soft cloth that is soaked in water and squeezed tightly, wipe dirt on the silver part of grid roller.

[6] Close the front cover.

Replacing consumable parts

Replacing absorption material for the flushing box

The flushing box is a part that keeps receiving ink discharged from the print head. Please replace the absorption material for the flushing box periodically. If used without replacing, it can cause damage to the print head.

Cleaning period:

- Approx. every 2 months (since it differs depending on usage frequency, please check periodically)

1. Checking steps

[1] Open the front cover.

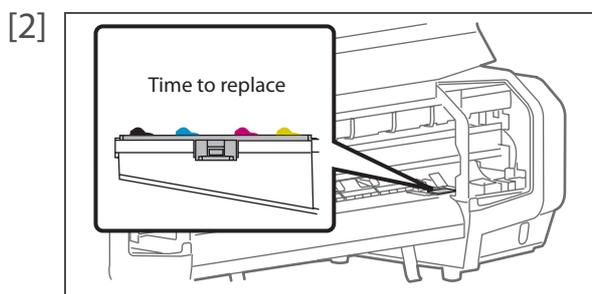

Check the absorption material for the flushing box.

- When there are lumps of ink rise from the frame of the flushing box, it is time to replace.

[3] Close the front cover.

2. Replacing steps

[1] Display the Printing Preferences screen of printer driver.

 ["Displaying the Printing Preferences screen of printer driver" on page 8](#)

[2]

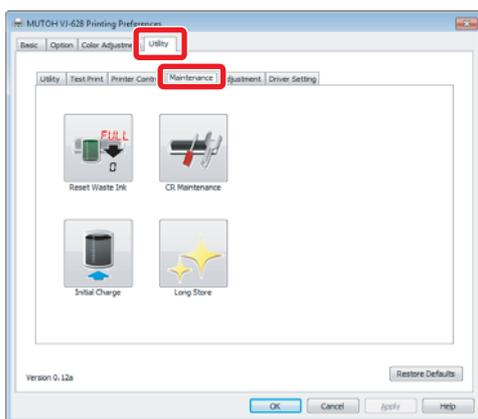

Click the [Maintenance] tab under the [Utility] tab.

[3]

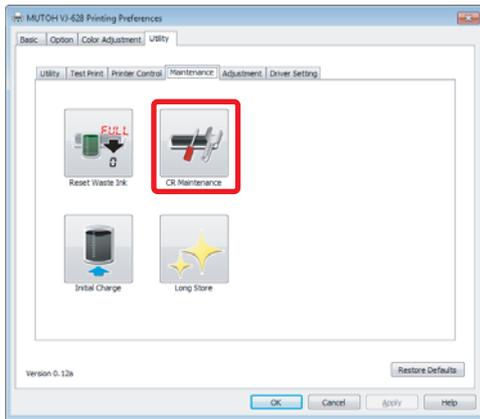

Click [CR Maintenance].

- The VSM remote panel opens.



Note

- VSM can be launched directly.
 ["Launching VSM" on page 9](#)

[4] Click [Start].

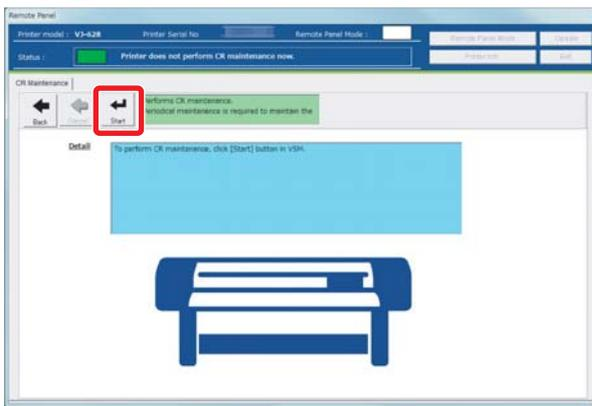

[5]

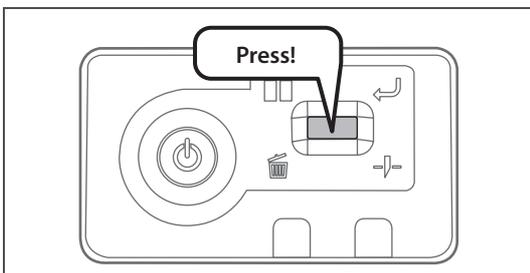

Short press the operation key on the operation panel.

- The carriage moves to the maintenance position inside the front cover.

[6] Open the front cover.

[7]

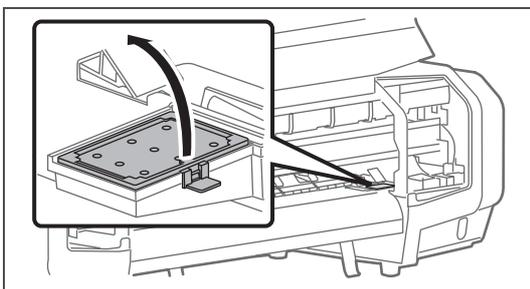

Remove the absorption material for the flushing box.

- Pull the tab up of the absorption material for the flushing box, and release the hook.



Important!

When removing the absorption material for the flushing box, be cautious of ink drops.

[8]

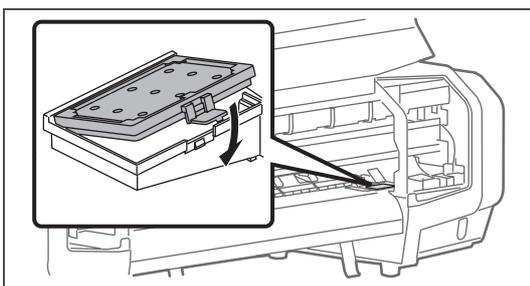

Attach new absorption material for the flushing box.

[9] Close the front cover.

[10]

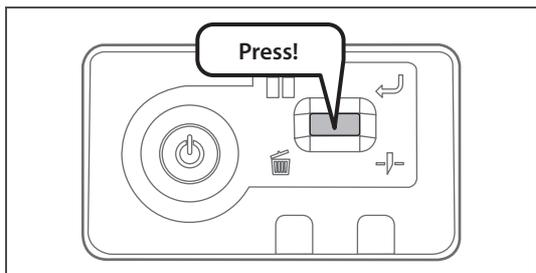

Short press the operation key on the operation panel.

- The carriage moves to the original position inside the front cover.

Replacing cutter

When the cutter blade becomes dull, replace with a new cutter.

CAUTION

- Do not push the knob of cutter or release suddenly.
Because there is a spring under the cutter, the cutter can jump out.
- Do not touch the cutter blade.
It may cause injury.

Steps

[1] Open the front cover.

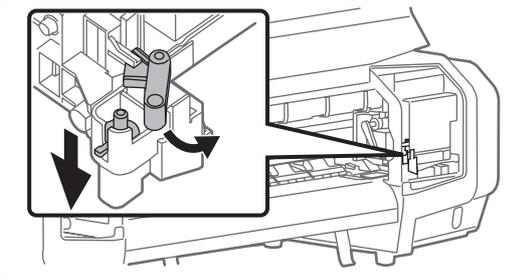
[2]  Move the cutter holder a little so that the cutter can be removed.

- While pushing down the cutter knob lightly, move the cutter holder to your side.

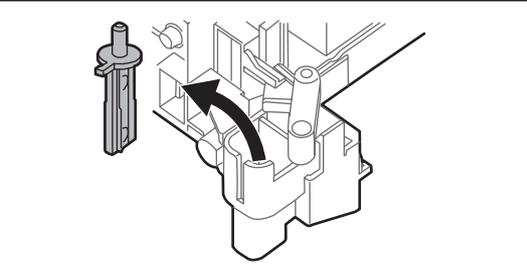
[3]  Remove the cutter.

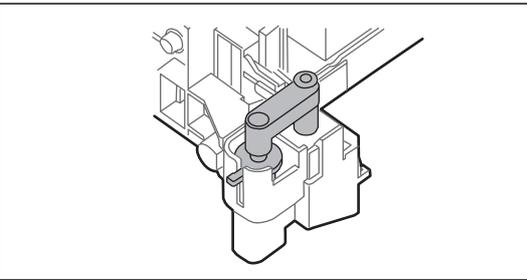
[4]  Attach a new cutter.

- Set the cutter for the cutter holder to be in the original position.

[5] Close the front cover.

Transporting and long-term storage

Please refer to this section when transporting or storing this product for a long time.

Transporting

When transporting this product, it is necessary to wash inside with cleaning cartridge, discharge waste ink and fixate the print head with packaging material. If transported as it is, it can cause ink leakage and damage to the print head.

When it is used again, conduct reinstallation work and initial charging.

Important!

- When moving this product, always empty the waste ink tank even if it is for a short distance. If ink splashes inside the waste ink tank while being moved, it can cause damage.
- Do not tilt, set against something or place this product upside down. Otherwise the ink may leak or the handling mentioned above may cause abnormality.

1. Head cleaning and discharging waste ink

[1] Display the Printing Preferences screen of printer driver.

 ["Displaying the Printing Preferences screen of printer driver" on page 8](#)

[2]

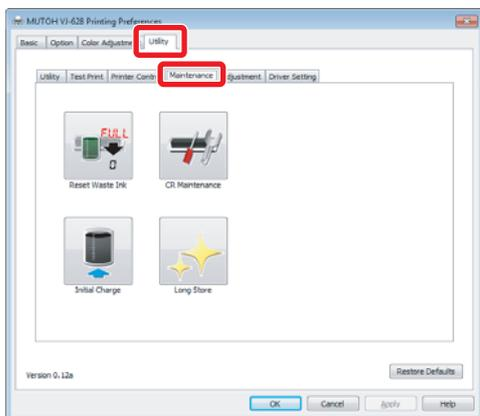

Click the [Maintenance] tab under the [Utility] tab.

[3]

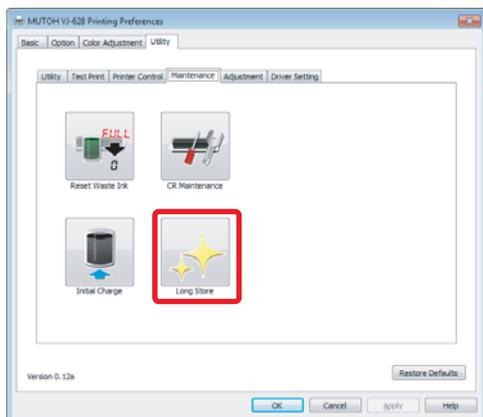

Click [Long Store]

- The VSM remote panel opens.

Note

- VSM can be launched directly.

 ["Launching VSM" on page 9](#)

- [4] Click [Start] in the [Longstore] tab.
- Conduct head cleaning following the screens.
 - After head cleaning is done, do not conduct re-launching and initial charging.

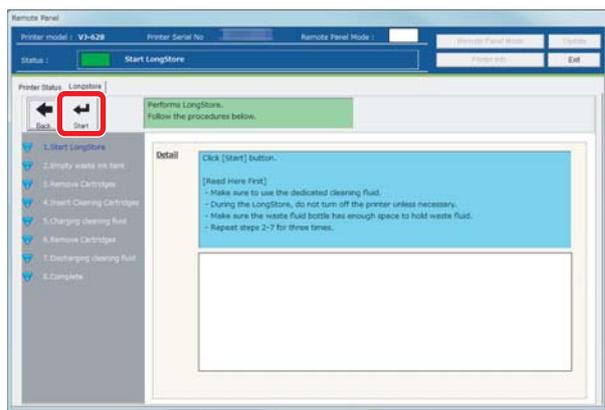

- [5] Empty the waste ink tank.
 🖱️ ["Emptying waste ink tank" on page 49](#)

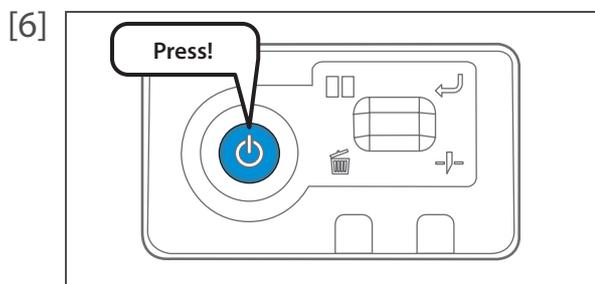

- Turn the power button of this product OFF.
- Blue light becomes OFF.
 - The product starts powering off operations.

2. Repacking

[1] Remove all cables like power cable.

[2] Open the front cover.

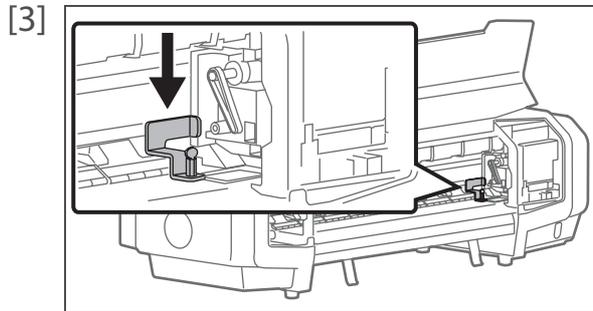

Attach the head fixing plate with screws.

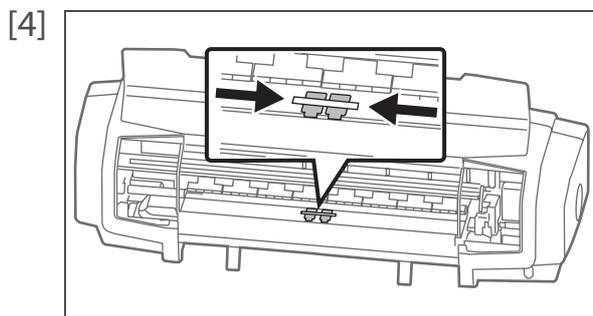

Move the paper guides to the center and place taping.

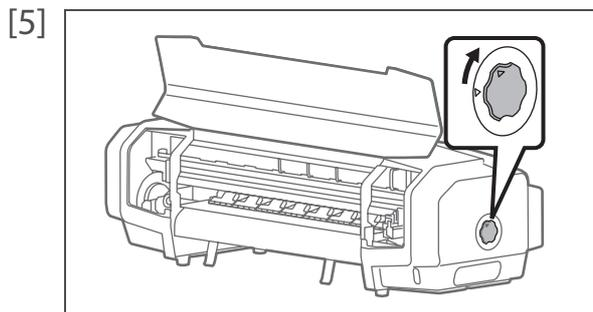

Turn the media fixing knob to release the lock.

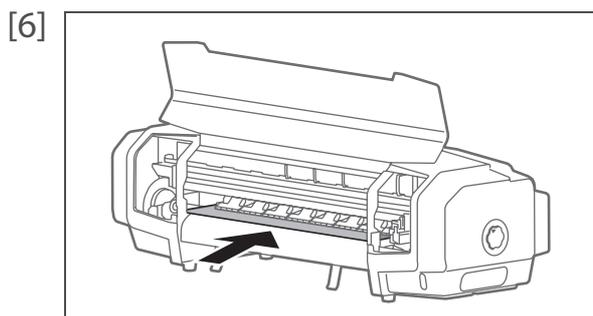

Attach the roller protective sheet.

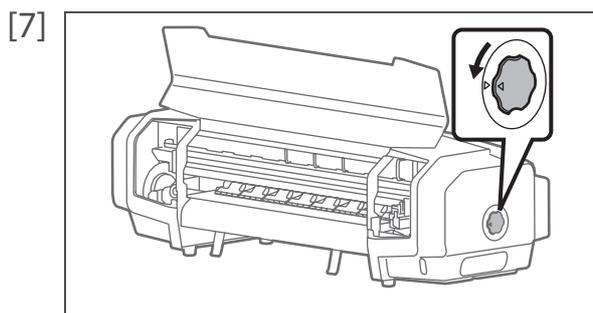

Turn the media fixing knob to lock.
• The roller protective sheet is fixed.

[8] Close the front cover.

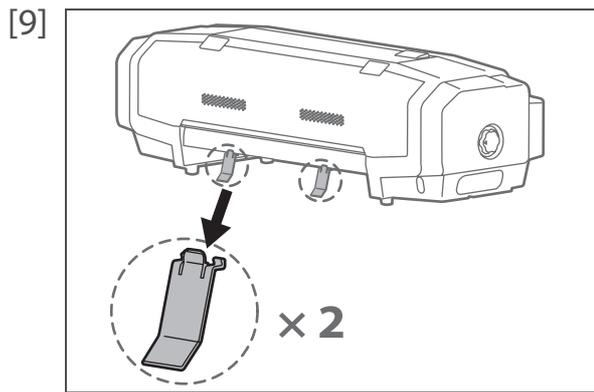

Remove 2 media guides.

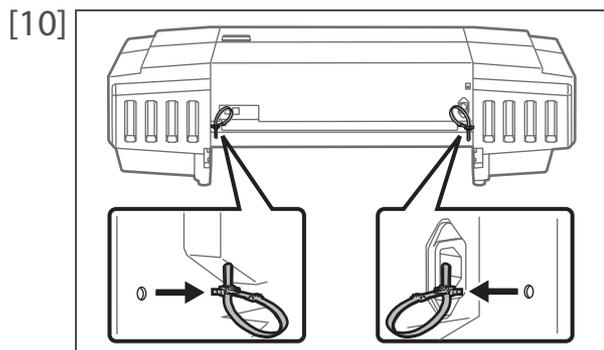

Remove 2 tying bands.

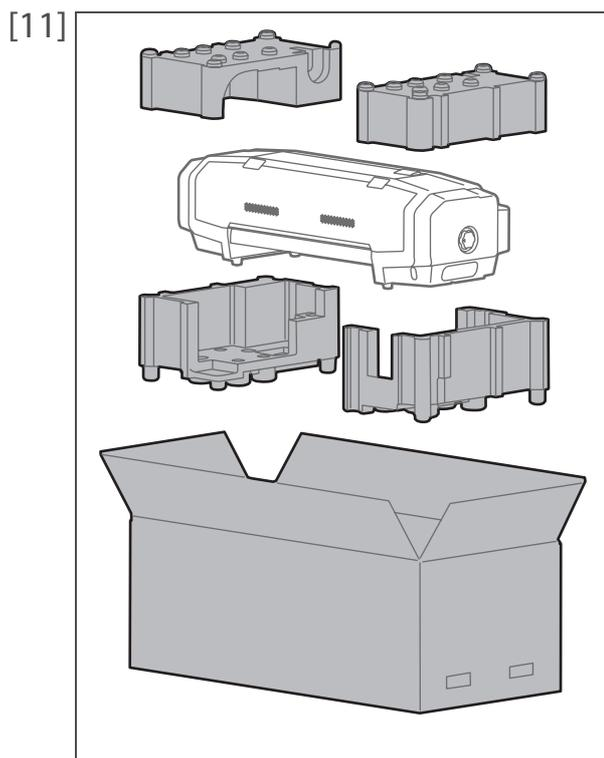

Attach protection materials, and place the product inside the package box

3. Reinstalling

- [1] Referring to "Startup Guide" , unpack the product and assemble.
 - Conduct up to "Starting Setup" .
- [2] Conduct initial charging.
 -  ["Initial charging" on page 67](#)

Initial charging

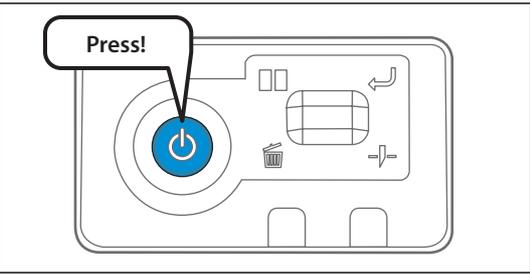
- [1]  Turn the power button of this product ON.
- Blue light becomes ON.
 - The product starts initialization operations.

- [2] Display the Printing Preferences screen of printer driver.
 ["Displaying the Printing Preferences screen of printer driver" on page 8](#)

- [3] Click the [Maintenance] tab under the [Utility] tab.

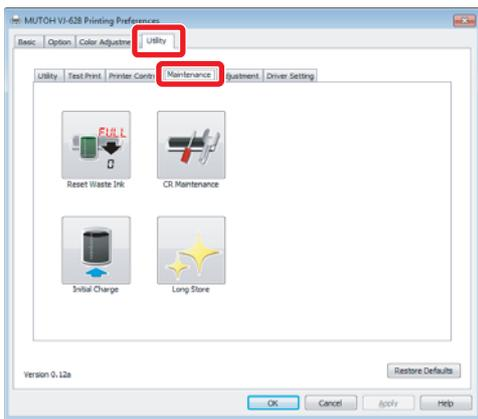

- [4] Click [Initial Charge].
- The VSM remote panel opens.



Note

- VSM can be launched directly.
 ["Launching VSM" on page 9](#)

- [5] Click [Start] after emptying the waste ink tank.
 ["Emptying waste ink tank" on page 49](#)

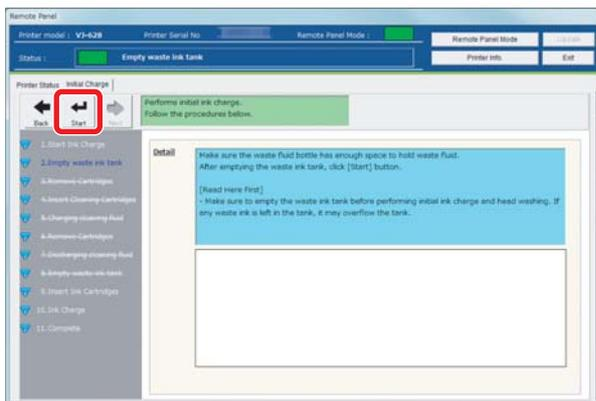

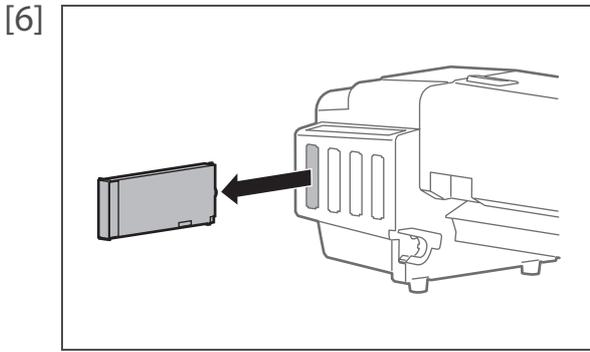

When ink cartridges are inserted to the cartridge slots, remove them all.

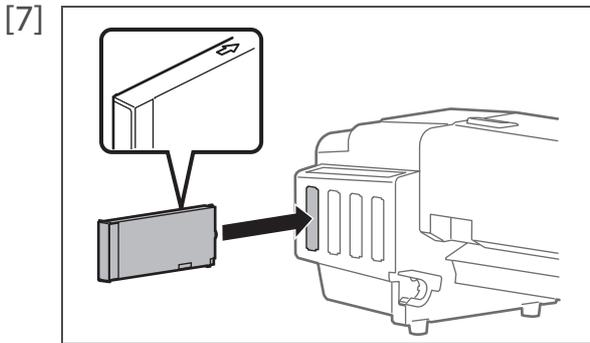

Insert cleaning cartridge to all cartridge slots.

- The arrow should face up.
- Insert all the way to the end.
- Start charging cleaning fluid

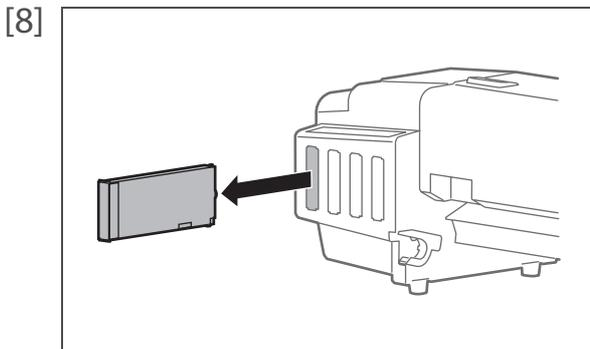

After cleaning fluid charging is done, remove all cleaning cartridges.

- Cleaning fluid starts to be discharged.

[9] After emptying the waste ink tank, click [Start].

["Emptying waste ink tank" on page 49](#)

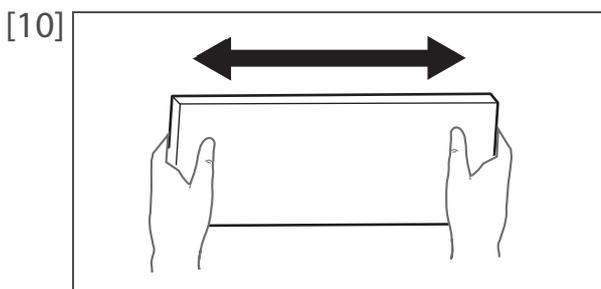
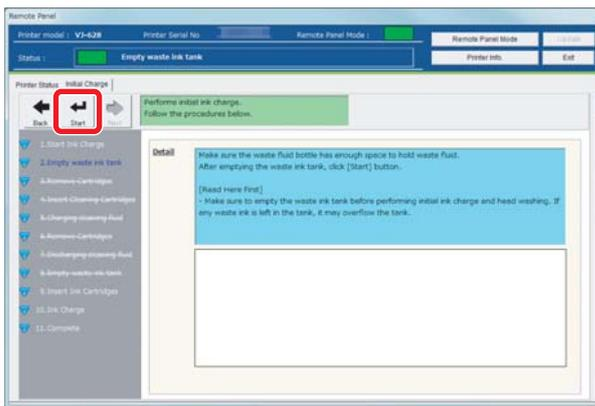

Shake the ink cartridge 2 or 3 times lightly.

[11]

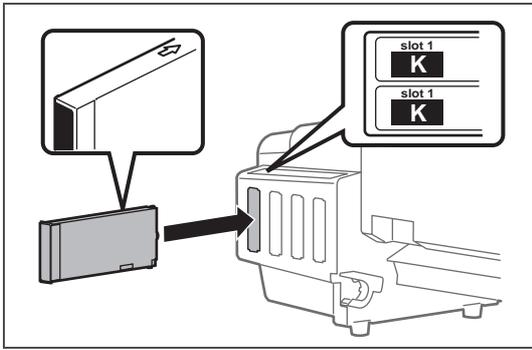

Insert ink cartridge to this product.

- Match the label of this product to the color of ink cartridge.
- The arrow should face up.
- Insert all the way to the end.

 Note

- After all ink cartridges are inserted, this product starts ink charging.

[12] In the [Finish] screen, click [Back].

- It finishes initial charging.

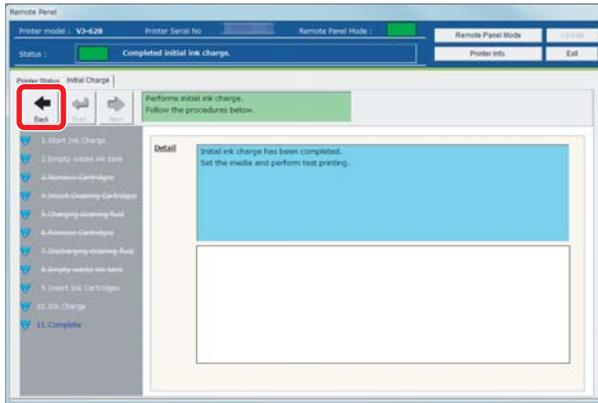

Storing for a long time

- [1] When not using for a long time, conduct head washing and discharging of waste ink.
 ["Transporting" on page 62](#) in ["Head cleaning and discharging waste ink"](#)
- [2] When used again, conduct initial charging.
 ["Initial charging" on page 67](#)

Chapter 4 Appendix

Troubleshooting	72
Handling messages/error messages.....	72
Specifications of this product	75
Drawing area.....	75
List of specifications.....	76

Troubleshooting

Handling messages/error messages

Checking message/error/warning

VSM is used to check error/warning when problem happens and to check messages while the product is operating correctly.

- [1] Launch VSM.
["Launching VSM" on page 9](#)
- [2] Check [Status Info].
 - Message/error/warning contents are displayed.
 - When countermeasures are displayed, follow them.

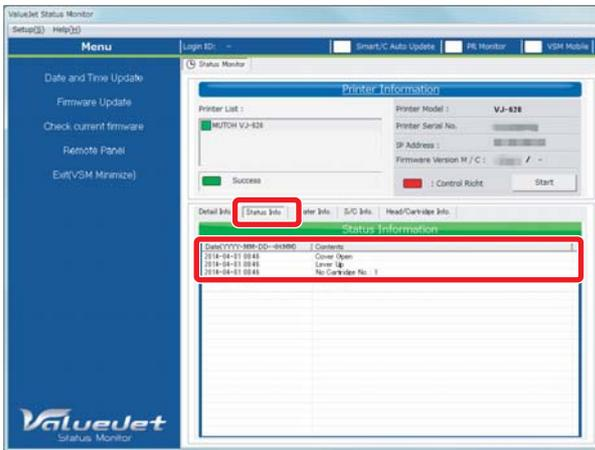

Note

- When the remote panel of VSM is launched, it can be also checked in [Printer Status] - [Status Info].
- Operations may be temporarily paused when an error occurs. When an error is corrected, it restarts the operation.

Error display of operation panel

The error LED in the operation panel becomes ON (flashes in warning state), and a buzzer sounds.

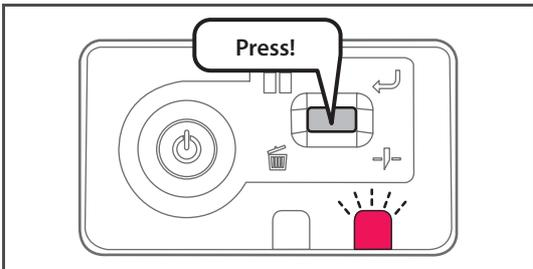
- [1]  Short press the operation key on the operation panel, when the buzzer continues sounding.
 - The buzzer stops.

- [2] Check error/warning contents with VSM and handle the error/warning.
["Checking message/error/warning" on page 72](#)

Emergency mode

When a serious error happens, the data LED and error LED in the operation panel flash simultaneously, and the buzzer sounds in a fixed interval.

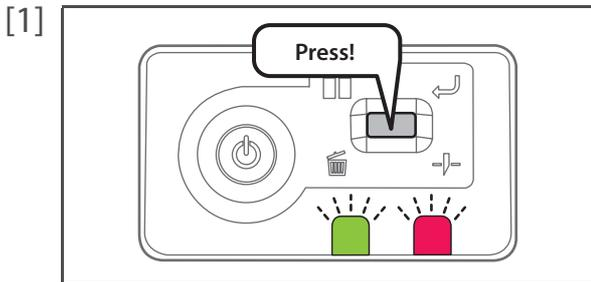

[1] Short press the operation key on the operation panel, when the buzzer continues sounding.

- The buzzer stops.

[2] Check the serious error contents with VSM.
["Checking failure contents of the emergency mode" on page 74](#)

- After checking it, proceed to step 5.
- When the status monitor cannot be viewed, proceed to step 3.

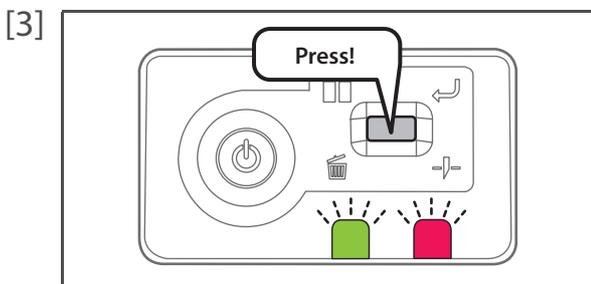

[3] When the status monitor cannot be viewed, short press the operation key on the operation panel again.

- LED flashes and the buzzer sounds in a regular pattern. The pattern indicates error number.

[4] Count the number of buzzer sounds (or number of short flashes of LED).

- Error number is 3 digits.
- Long sounding buzzer indicates a digit of error number, and the short sounding buzzer after the long buzzer indicates error number.
- For example, the No. 154 error shows the next pattern.
 3 long, **1 short**, 2 long, **5 short**, 1 long, **4 short**, 3 long.



Note

- The pattern will not repeat. To check it again, short press the operation key on the operation panel.
- If error number of a digit is "0", a long buzzer (buzzer indicating a digit), then after having no sound for a fixed time, a long buzzer indicating the next digit sounds. For LED, there is a long flash only, and it moves on to a long flash without having a short flash.

[5] Check the followings.

- Open the front cover and if media is jammed, remove it.
- If there is a replaced part, check it is installed correctly.

[6] Turn the power of this product OFF. Wait for 10 seconds or more and turn the power ON.
 If the same error occurs after re-launching, please contact your local MUTOH dealer.

Checking failure contents of the emergency mode

- [1] Launch VSM.
☞ "Launching VSM" on page 9
- [2] Check [Printer Information] and [Detail Info].
 - Contents of serious errors and countermeasures are displayed.

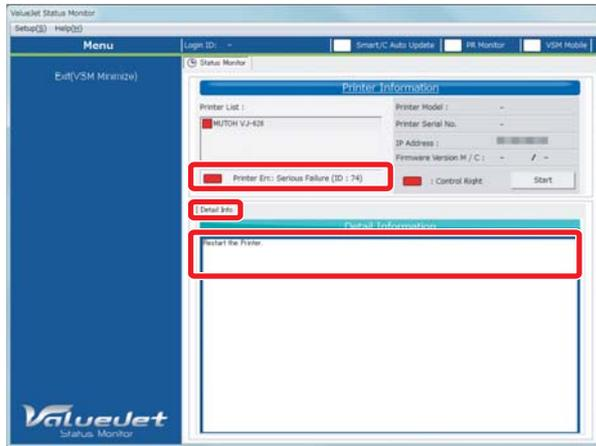

Specifications of this product

Drawing area

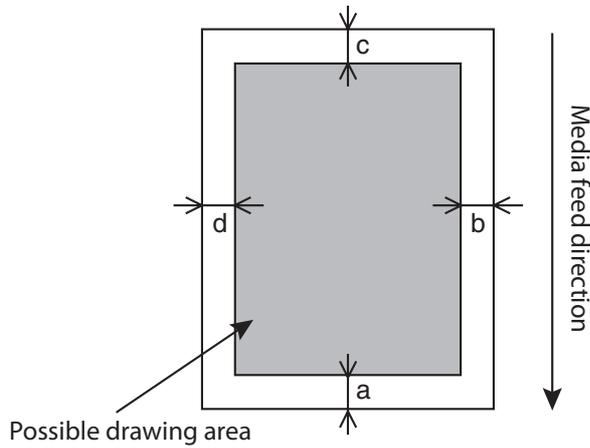

a=5 mm *1 *2
b=5 mm to 25 mm *3
c=5 mm
d=5 mm to 25 mm *3

*1 After media initial and manual feedback, and pasting prevention process, printing starts at 15 mm.

*2 While the media initial tip and auto-cut is ON, printing starts at 40 mm.

*3 According to the remote panel settings

List of specifications

Model name	VJ-628	
Print method	On demand piezo method	
Drive method	Firmware servo/DC motor drive	
Paper feed method	Horizontal conveyance, roll paper, set from the back of the product, front discharge paper with paper feed operation, limited to outward roll	
Media fix	Pressure roller down method with manual media fixing knob	
Conditions of usable media	Roll paper peripheral	150 mm
	Roll paper weight	9 kg or less
	Maximum paper width	630 mm (In case of paper tube > paper width, paper tube width)
	Maximum paper thickness	Head height when set to "Low": 0.3 mm Max. Head height when set to "High": 1.3 mm Max.
Maximum print width	620 mm	
Media cut method	Auto cut or manual cut	
Heater	Installed under the media guide, OFF/30 °C to 45 °C	
Head height adjustment	2 levels, Low and High	
CPU	64 bit RISC CPU	
Memory	256 MB	
Interface	Ethernet(10/100BASE-TX)	
Ink	Color	4 colors (Black, Cyan, Magenta, Yellow) 6 colors (Black, Cyan, Magenta, Yellow, Light Cyan, Light Magenta)
	Type	220 ml cartridge
Waste ink tank	Fixed to the body type, capacity 1500 ml, waste ink discharge by users	
Environmental conditions	Operating environment	Temperature 20 to 32 °C, humidity 40 to 60 %, no condensation.
	Ranges to ensure printing precision	Temperature 22 to 30 °C, humidity 40 to 60 %, no condensation.
	Change rate	Temperature: No more than 2 °C per 1 hour Humidity: No more than 5 % per 1 hour
	Environment for storage	<ul style="list-style-type: none"> If not charged with ink when stored: up to 6 months Temperature -20 to +60 °C, humidity 20 to 80 %. If charged with ink when stored: up to 1 week* Temperature -10 to +40 °C, humidity 20 to 80 %. *Up to 4 days if the ambient temperature is 32 °C or higher.

Power supply specifications	Voltage	AC 100 V to 120 V $\pm 10\%$ or 200 V to 240 V $\pm 10\%$
	Frequency	50 / 60 Hz ± 1 Hz
	Capacity	No less than 10 A
Power consumption	Power off	AC100 V to 120 V, 1 W or below AC200 V to 240 V, 1.1 W or below.
	Operation	830 W or below
Voltage switch		Manual switching with 100/200 V, Selector switch set on 200 V when shipped.
Current consumption	100 V to 120 V	6.5 A or below
	200 V to 240 V	3.5 A or below
External dimensions	Height	366 mm (with exclusive stand: 1166 mm)
	Width	1190 mm
	Depth	438 mm (with exclusive stand: 590 mm)
Weight	Main body	31.8 kg
	Legs	8.7 kg

MUTOH