



AC INFINITY

# **CLOUDLAB SERIES**

## **HEAVY-DUTY GROW TENT**

USER MANUAL



## WELCOME

Thank you for choosing AC Infinity. We are committed to product quality and friendly customer service. If you have any questions or suggestions, please don't hesitate to [contact](#) us. Visit [www.acinfinity.com](http://www.acinfinity.com) and click contact for our contact information.

### EMAIL

[support@acinfinity.com](mailto:support@acinfinity.com)

### WEB

[www.acinfinity.com](http://www.acinfinity.com)

### LOCATION

Los Angeles, CA

## MANUAL CODE CL2010X1

### PRODUCT

CLOUDLAB 422  
CLOUDLAB 632  
CLOUDLAB 642  
CLOUDLAB 733  
CLOUDLAB 844  
CLOUDLAB 866

### MODEL

AC-CBA422  
AC-CBA632  
AC-CBA642  
AC-CBA733  
AC-CBA844  
AC-CBA866

### UPC-A

819137021532  
819137021556  
819137021549  
819137021563  
819137021570  
819137021587

# MANUAL INDEX

Manual Index .....	Page 5
Key Features .....	Page 6
Product Contents .....	Page 7
Tent Set Up .....	Page 9
Mounting Guide .....	Page 15
Ventilation Guide .....	Page 16
Other AC Infinity Products .....	Page 17
Warranty .....	Page 18

# KEY FEATURES

## HIGH-DENSITY CANVAS

Mylar canvas with 2000D density rating to be 100% external light-proof. Diamond-patterned interior lining amplifies reflectivity.

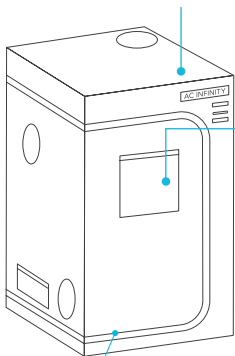

## HEAVY-DUTY FRAME

Thick 22mm steel tubes and connectors provide the tent with a sturdy structure. Can carry fans and lights up to 100 pounds.

## VIEWING WINDOW

Clear and adjustable window offers you a snapshot of the interior without compromising your environment.

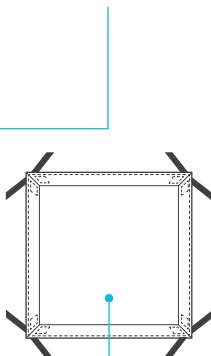

## SPILL TRAY

Reflective waterproof lining that catches water, soil, and other debris to prevent leakage in the grow tent.

## CONTROLLER PLATE

Aluminum plate designed to mount fan and lighting controllers. Their cords can enter the tent securely through the plate's opening.

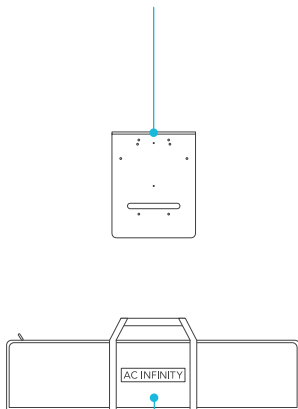

## STORAGE BAG

Includes a heavy-duty nylon carrying bag to neatly store the grow tent when not in use and allow easy transporting.

# PRODUCT CONTENTS

**CLOUDLAB SERIES** Included in all series

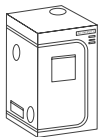

**CANVAS  
TENT**  
(x1)



**STORAGE  
BAG**  
(x1)

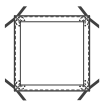

**SPILL  
TRAY**  
(x1)



**FILTER  
STRAPS**  
(x2)



**CONTROLLER  
SCREWS**  
(x10)



**CONTROLLER  
VELCRO**  
(x6)



**INNER FLAP  
VELCRO**  
(x2)

**CLOUDLAB SERIES** Included only with

**CLOUDLAB 844** AC-CBA844  
**CLOUDLAB 866** AC-CBA866

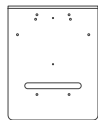

**CONTROLLER  
PLATE**  
(x1)

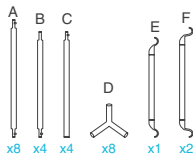

**FRAME POLES**

# PRODUCT CONTENTS

**CLOUDLAB SERIES** Included only with

**CLOUDLAB 422** AC-CBA422

**CLOUDLAB 733** AC-CBA733



CONTROLLER  
PLATE (\*SHORT)  
(x1)

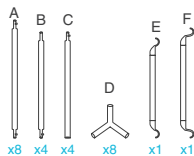

FRAME POLES

**CLOUDLAB SERIES** Included only with

**CLOUDLAB 632** AC-CBA632



CONTROLLER  
PLATE (\*SHORT)  
(x1)

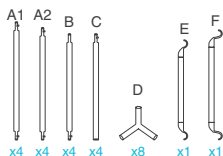

FRAME POLES

**CLOUDLAB SERIES** Included only with

**CLOUDLAB 642** AC-CBA642

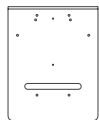

CONTROLLER  
PLATE  
(x1)

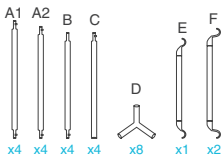

FRAME POLES



# TENT SETUP

## STEP 1

Insert the eight (A) poles into the floor end of the corner (D) pieces to create two bases. When assembling, make sure the feet of each corner (D) piece faces the floor with the arrow facing down.

NOTE: The poles in models AC-CBA632 and AC-CBA642 are labeled A1 and A2.

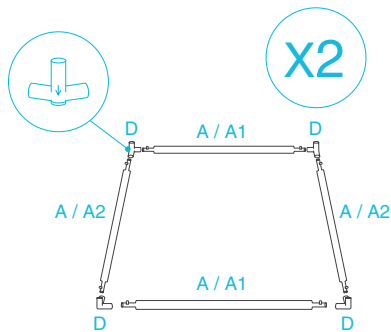

## STEP 2

Insert the four (B) poles into Base One. Insert the four (C) poles into Base Two.

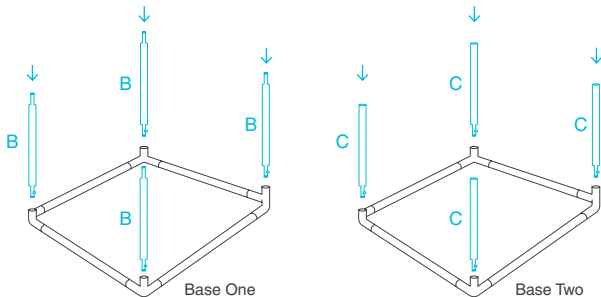

# TENT SETUP

## STEP 3

Unzip the tent so that three of the walls lay flat.

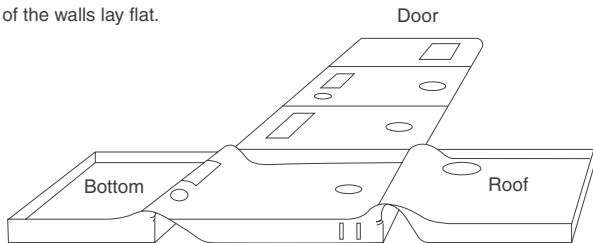

## STEP 4

Guide Base One into the floor of the tent, making sure its corners meet the tent's corners.

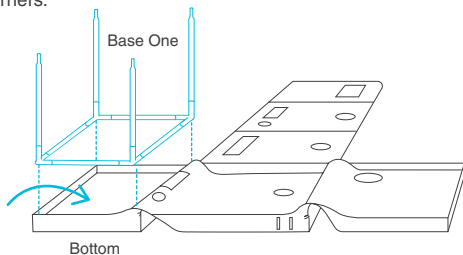

# TENT SETUP

## STEP 5

Insert the poles of Base Two into the poles of Base One to complete the frame.

\*Two people is recommended for this portion of the tent assembly.

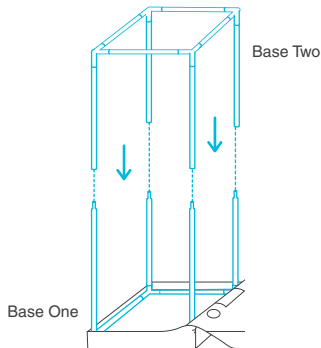

## STEP 6

Pull the roof over the assembled frame.

\*Two people is recommended for this portion of the tent assembly.

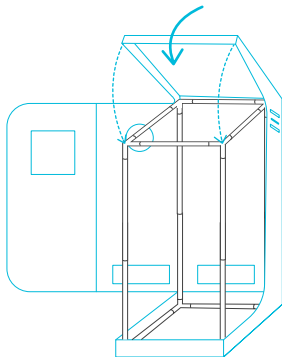

# TENT SETUP

## STEP 7

Pull the upper and lower zippers to close the walls and door.

\*Two people is recommended for this portion of the tent assembly.

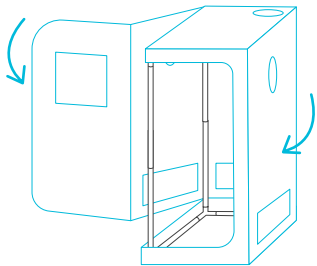

---

## STEP 8

You can neatly hold the window wall open any time by using its attached Velcro strap.

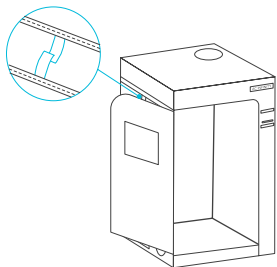

# TENT SETUP

## STEP 9

Add the roof support beams (E) then (F). Insert the spill pool into the tent and secure the Velcro straps around the poles.

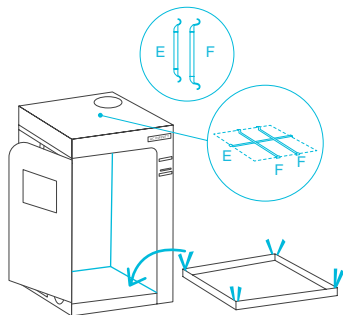

## STEP 10

Mount your controller onto the included bracket.

Use the included screws to mount an AC Infinity controller. Use the Velcro adhesive to attach a non-AC Infinity controller.

Refer to page 15 for mounting locations of your controller.

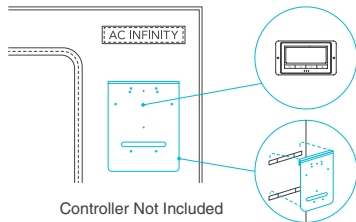

# TENT SETUP

## STEP 11

Slide the controller bracket assembly into the tent straps below the logo.

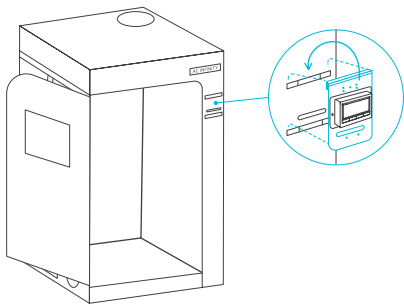

---

## STEP 12

Route your inline duct fan's power connector through the opening inside and plug it into your controller.

Plug the probe into the controller and route its cables through the opening.

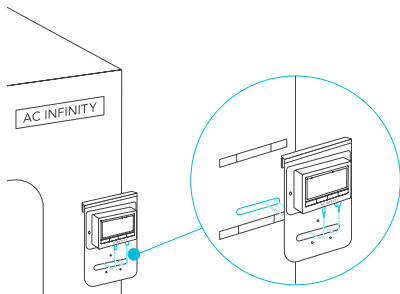

# MOUNTING GUIDE

## CONTROLLER PLATE

This grow tent includes an aluminum bracket with mounting holes bored for AC Infinity controllers. Mount your controller to the corresponding holes on the bracket. Route its wires through the oval opening and through the grow tent's flap.

To attach non-AC Infinity controllers, use the included Velcro adhesive to hold it onto the bracket.

### ONLY INCLUDED WITH

CLOUDLAB 642  
CLOUDLAB 844  
CLOUDLAB 866

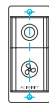
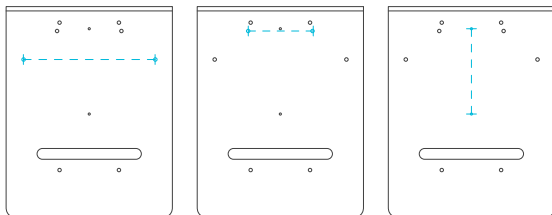

### ONLY INCLUDED WITH

CLOUDLAB 422  
CLOUDLAB 632  
CLOUDLAB 733

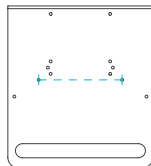
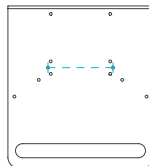
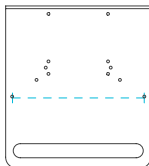

\*Controllers Sold Separately

# VENTILATION GUIDE

## INLINE FAN AND GROW LIGHT

First hang your inline duct fan by the roof support beams. Position the fan on the opposite end of your intake hole to optimize airflow. If you are installing a carbon filter inside, use the included straps to hang the carbon filter.

Then install your grow light. You may use rope clip hangers to install these products.

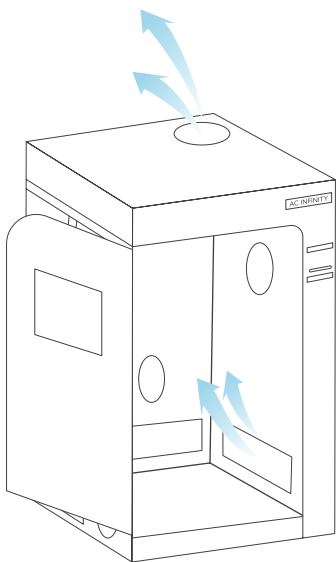

## DOUBLE-SIDED CINCHES

Install any necessary duct tubes onto the ducting ports. Use the cinches on either end to secure the duct tubes onto the grow tent.

## INTAKE HOLES

Introduce fresh air by using one of the two ventilation holes at the bottom of the grow tent. Open a passive intake screen or create active intake by attaching an additional inline fan to a duct port.

## NEED MORE INFORMATION?

Scan the QR code or visit [www.acinfinity.com](http://www.acinfinity.com) for more guides and tutorials.





# AC INFINITY PRODUCTS

## Inline Fans

The CLOUDLINE series is a line of duct fans designed to quietly ventilate AV rooms and closets, as well as various DIY air circulation and exhaust projects. Features a thermal controller with intelligent programming that will automatically adjust duct fan speeds in response to changing temperatures.

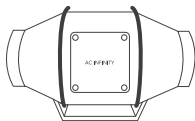

---

## Carbon Filter

The duct carbon filter is designed to eliminate odors and chemicals for grow tents and hydroponic spaces. It utilizes premium grade Australian charcoal that features greater absorption power and a longer lifespan. Enables maximum airflow pass through as part of an intake or an exhaust system.

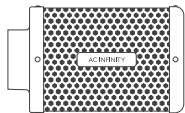

---

## Ducting Tubes

The four-layer ducting tube is used to direct airflow, designed for ventilation systems in applications like HVAC, dryers, and grow rooms. It is highly durable and flexible, and can be used anywhere from tight spaces to wide open areas.

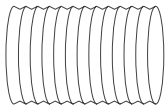

# WARRANTY

This warranty program is our commitment to you, the product sold by AC Infinity will be free from defects in manufacturing for a period of two years from the date of purchase. If a product is found to have a defect in material or workmanship, we will take the appropriate actions defined in this warranty to resolve any issues.

The warranty program applies to any order, purchase, receipt, or use of any products sold by AC Infinity or our authorized dealerships. The program covers products that have become defective, malfunctioned, or expressly if the product becomes unusable. The warranty program goes into effect on the date of purchase. The program will expire two years from the date of purchase. If your product becomes defective during that period, AC Infinity will replace your product with a new one or issue you a full refund.

The warranty program does not cover abuse or misuse. This includes physical damage, submersion of the product in water, incorrect installation such as wrong voltage input, and misuse for any reason other than intended purposes. AC Infinity is not responsible for consequential loss or incidental damages of any nature caused by the product. We will not warrant damage from normal wear such as scratches and dings.

For more information about our dealers and distributors, please contact our customer service at support@acinfinity.com or (626) 923-6399 Monday to Friday (9:00 am to 5:00 pm PST).



**If you run into any issues with this product, contact us and we'll happily issue a replacement or a full refund!**



**COPYRIGHT © 2020 AC INFINITY INC. ALL RIGHTS RESERVED**

No part of the materials including graphics or logos available in this booklet may be copied, photocopied, reproduced, translated or reduced to any electronic medium or machine readable form, in whole or in part, without specific permission from AC Infinity Inc.







[www.acinfinity.com](http://www.acinfinity.com)