



AC INFINITY

CLOUDLINE

AIR FILTRATION SYSTEM

USER MANUAL

WELCOME

Thank you for choosing AC Infinity. We are committed to product quality and friendly customer service. If you have any questions or suggestions, please don't hesitate to [contact](#) us. Visit www.acinfinity.com and click contact for our contact information.

EMAIL

support@acinfinity.com

WEB

www.acinfinity.com

LOCATION

Los Angeles, CA

MANUAL CODE CL2105X1

PRODUCT

Air Filtration System 4

Air Filtration System 6

Air Filtration System 8

MODEL

AC-FKS4

AC-FKS6

AC-FKS8

UPC-A

819137022065

819137021891

819137022072

MANUAL INDEX

Manual Index	Page 5
Key Features	Page 6
Product Contents	Page 7
Installation (Hanging)	Page 9
Installation (Motor Cap Orientation)	Page 14
Installation (Mounting)	Page 15
Installation (Filter & Ducting)	Page 20
Powering and Setup	Page 25
Controller Upgrade	Page 26
Cleaning	Page 27
Programming	Page 29
FAQ	Page 30
Other AC Infinity Products	Page 32
Warranty	Page 33

KEY FEATURES

DUAL BALL BEARINGS

The motor contains ball bearings with a 67,000 hour lifespan. Enables the fan to be mounted in any orientation.

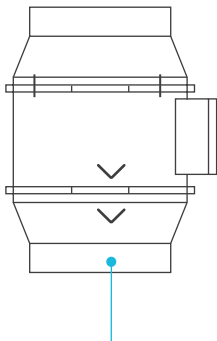

IP-44 PROTECTION

The inline duct fan is sealed to Ingress Protection 44 standards, rated with high resistance to liquids and dust.

ACTIVATED CARBON

Features RC412 1200+ IAV Australian charcoal with high adsorption rate to completely block odor and scrub the air.

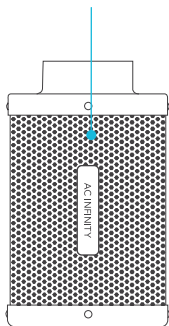

REVERSIBLE FLANGES

The flanges can be removed and placed on the opposite ends to fully utilize the carbon bed inside.

SPEED CONTROLLER

Single button controller with circular dot display that enables fan speed control in ten speeds.

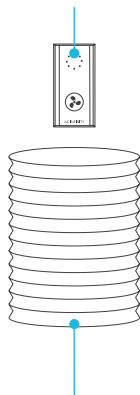

FLEXIBLE DUCTING

The outer layer is made of dual PVC thermoplastic that protects the aluminum from cuts and tears.

PRODUCT CONTENTS

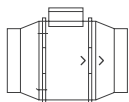

DUCT FAN SYSTEM (x1)



FLEXIBLE DUCTING (x1)

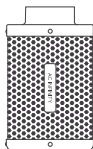

CARBON FILTER (x1)

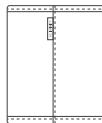

PREFILTER CLOTH (x2)



SPEED CONTROLLER (x1)



TYPE-C ADAPTER (x1)



DUCT CLAMP (x2)



DUCT FAN SCREW SET (x4)



ROPE CLIP (x2)



FILTER STRAPS (x2)

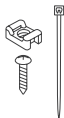

WIRE MOUNT (x6)

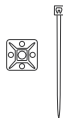

PROBE MOUNT (x1)



WOOD SCREWS (WALL MOUNT) (x1)

PRODUCT CONTENTS

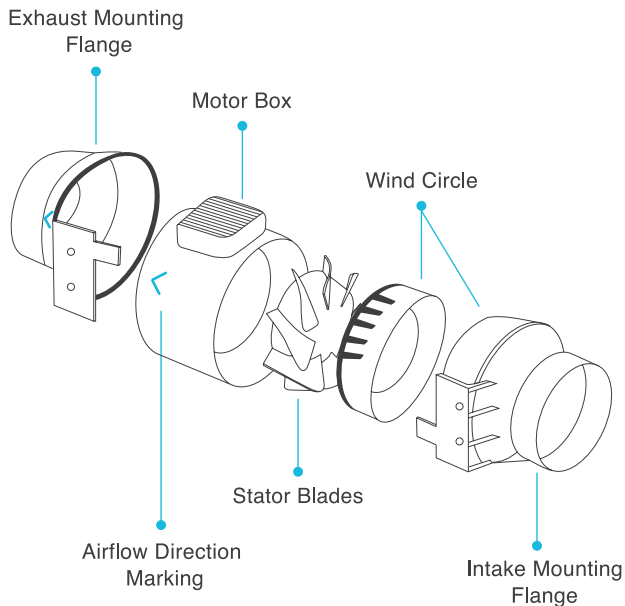

INSTALLATION

HANGING

INTAKE AND EXHAUST

This fan can be used as either an intake fan or an exhaust fan in grow rooms and larger grow tents. To achieve optimal whole space ventilation, the intake fan or opening - if not using a fan - must be situated at a bottom corner of your grow space. The exhaust fan must be hung (shown below) or mounted at the highest opposite corner possible.

Make sure the intake fan's airflow arrow is pointing towards your grow space and the exhaust fan's arrow pointing away from your grow space.



To use this filter in intake applications, place the filter inside your grow space. Make sure the filter is connected to your inline duct fan's intake end before completing the installation.

To use this filter in exhaust applications, place the filter outside your grow space. Make sure the filter is connected to your inline duct fan's exhaust end before completing the installation.

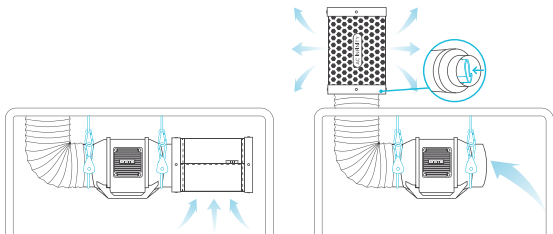

INSTALLATION

HANGING - ROPE CLIPS

Hanging Upward

Loop the two rope hangers around a pole and clip the carabiners onto each other. Shorten the loops as needed.

Hang the fan by the duct flanges to secure it.

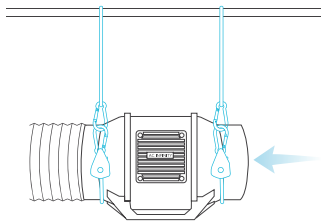

Hanging Downward

Loop the two rope hangers around a pole and the fan's bracket.

Clip the carabiners onto each other. Shorten the loops as needed.

Make sure the fan's airflow arrow is pointing towards your desired direction.

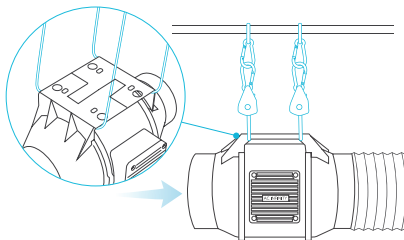

INSTALLATION

HANGING - STRAPS

STEP 1

Loop the strap around the bracket and a pole.

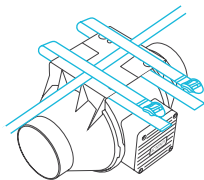

STEP 2

Slip the strap through the inner ladder lock slot from the bottom.

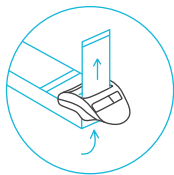

INSTALLATION

HANGING - STRAPS

STEP 3

Route the strap into the outer ladder lock slot from the top. Adjust the length of the completed loop as needed.

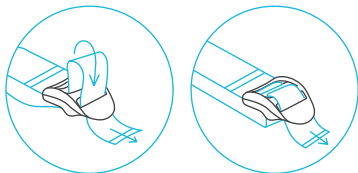

Adjust to size

STEP 4

Tuck the loose end through the center gap of the ladder lock to secure the loop.

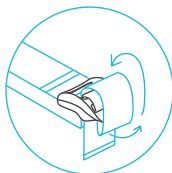

Loop through middle
to lock in place

INSTALLATION

HANGING - STRAPS

STEP 5(a) - Hanging Downward

Let the fan hang by the pole once the straps are secure.

Make sure the fan's airflow arrow is pointing towards your desired direction.

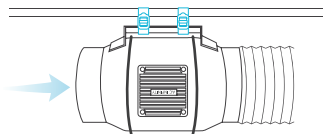

STEP 5(b) - Hanging Upward

To hang the fan right-side up, loop and tighten the straps, as shown in steps 1-4, around the pole.

Hang the fan by the duct flanges to secure it.

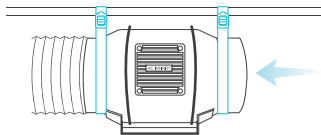

INSTALLATION

MOTOR CAP

STEP 1

When hanging the fan downwards, the motor cap will appear upside down. You may rotate this motor cap so that it appears right side up.

Unscrew the motor cap using a screwdriver.

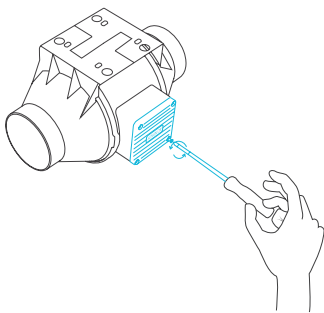

STEP 2

Rotate the motor cap to your desired orientation. Reapply the screws.

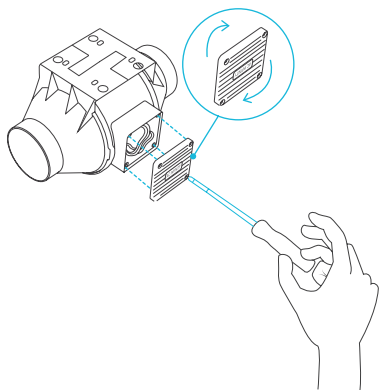

Rotating the motor cap will not void your warranty.

INSTALLATION

MOUNTING

STEP 1

Unscrew the bolts from the plastic rings using a screwdriver.

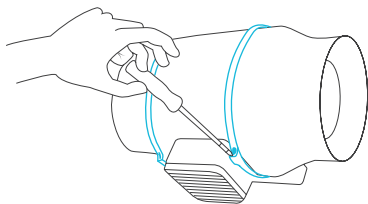

STEP 2

Remove the motor box from the flange bracket. Remove the wind circle between the motor box and the intake flange.

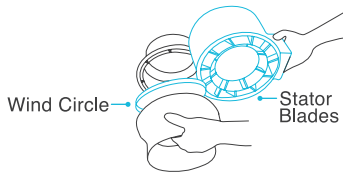
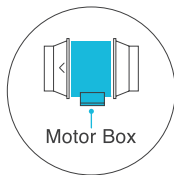

INSTALLATION

MOUNTING

STEP 3

Use the flange bracket to set your desired fan position. Mark the four mounting holes.

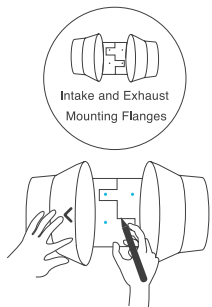

STEP 4

Drill four holes into the marked locations. Make sure your mounting area is structurally sound and free from obstruction.

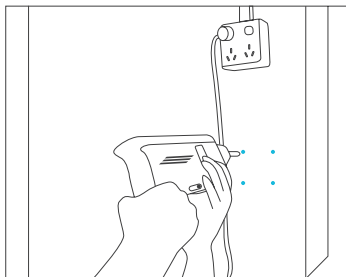

INSTALLATION

MOUNTING

STEP 5

If you are mounting onto anything other than a wood support or stud, insert the included four wall anchors into the drilled mounting holes. You may need to use a hammer to secure them through the holes.

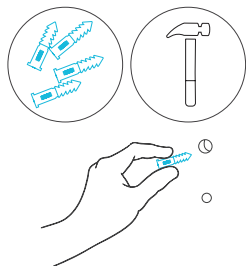

STEP 6

Align the flange bracket's holes with the wall anchors. Screw in four wood screws with a screwdriver or drill to secure the flange bracket.

Make sure its airflow arrow is pointing in your desired direction.

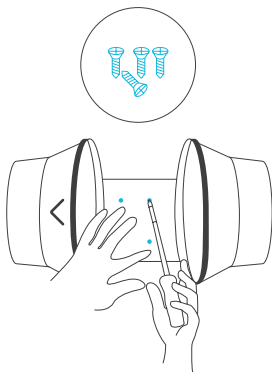

INSTALLATION

MOUNTING

STEP 7

Place the wind circle back into the intake flange.

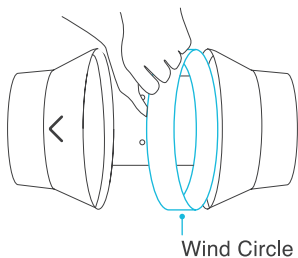

STEP 8

Slide the motor box back into the flange bracket, making sure its airflow arrow is pointing in the same direction as the flange bracket's arrow. Screw the bolts back into the plastic rings to secure the motor box to the flange bracket.

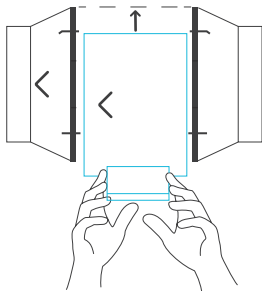

INSTALLATION

MOUNTING

STEP 9

Use the included duct clamps to secure your ducting to either end of the duct fan, making sure there is a tight seal. Tighten the duct clamps using a flathead screwdriver.

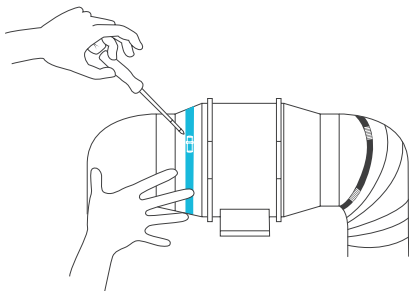

INSTALLATION

FILTER & DUCTING

STEP 1

Slip the cloth over the filter to block dust and other particles from passing through. Make sure the entire steel mesh is covered by the cloth.

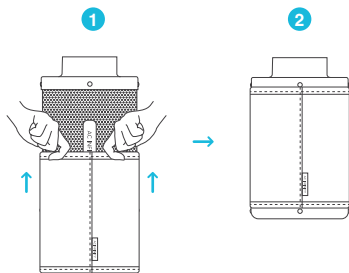

STEP 2

Connect your duct tube over the filter. Use duct clamps to secure the connection. You may also apply ducting tape before using the duct clamps for even further security.

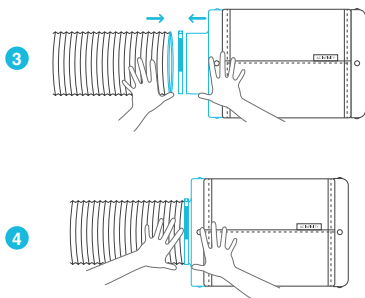

INSTALLATION

FILTER & DUCTING

STEP 3

You may also connect the filter directly to your inline duct fan. Use ducting tape to secure them together.

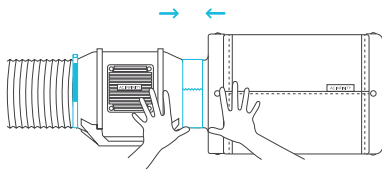

STEP 4

If your filter is placed in a humid space, position it at the highest point possible.

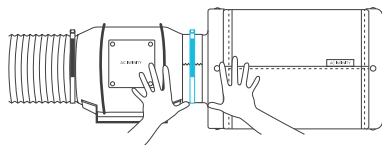

INSTALLATION

OVERHEAD HANGING

STEP 1

Loop the strap around a hanging pole.

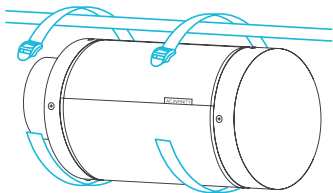

STEP 2

Slip the strap through the inner ladder lock slot from the bottom.

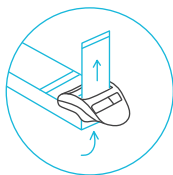

INSTALLATION

OVERHEAD HANGING

STEP 3

Route the strap into the outer ladder lock slot from the top. Adjust the length of the completed loop as needed.

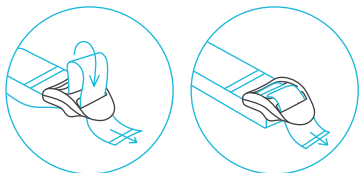

Adjust to size

STEP 4

Tuck the loose ends through the center gap of the ladder lock to secure the loop.

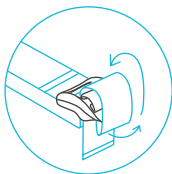

Loop through middle
to lock in place

INSTALLATION

OVERHEAD HANGING

STEP 5

Connect your filter to your ductwork using your preferred method, as shown on page 20 and 21.

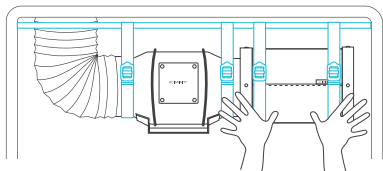

POWERING AND SETUP

STEP 1

Plug the duct fan's USB-C connector into the speed controller.

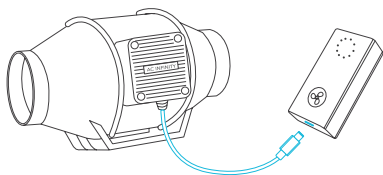

STEP 2

Plug the fan's power cord into an AC power outlet to power the fan and controller.

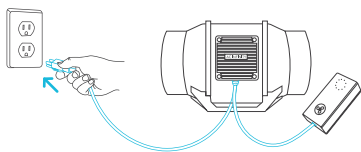

CONTROLLER UPGRADE

This kit features the CLOUDLINE A-Series fan which includes the standard speed controller. The controller may be upgraded to a B-Series or T-Series controller as shown below.

B-SERIES CONTROLLER (Sold Separately)

The B-Series smart controller features an additional port to control two EC motor fans of any size. The controller and two EC-motor fans must be plugged into an outlet to power them.

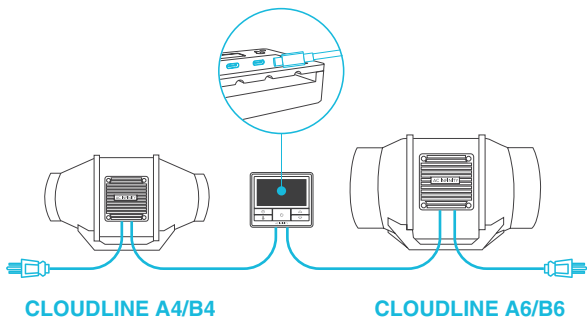

T-SERIES CONTROLLER (Sold Separately)

If you have an existing T-Series controller, you may use the included USB Type-C to 4-pin Molex adapter to connect it with this fan. Plug your fan's USB connector into the dongle. Then plug the dongle into your T-Series controller.

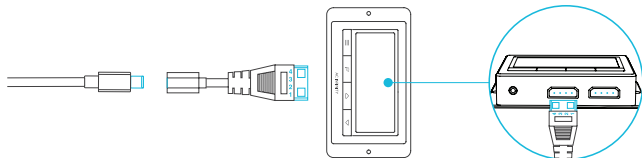

CLEANING

STEP 1

Remove the motor box from the mounting flange. Refer to steps 1 and 2 on page 15 to learn how to remove the motor box.

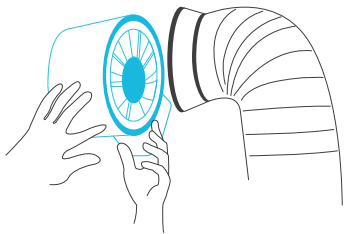

STEP 2

Use a damp cloth to clear the impeller and fan blades of any dust and debris. Remove the wind circle in between the motor box and input flange.



CLEANING

STEP 3

Clear the stator blades of any dust and debris on the opposite end. Clean the area inside the output and exhaust flanges.

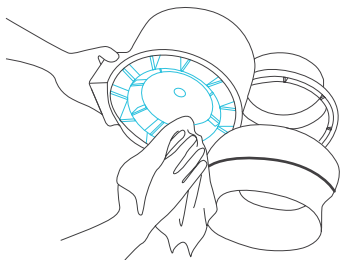

STEP 4

Secure the motor box onto the mounting flanges. Refer to steps 7 and 8 on page 18 to learn how to secure the motor box.

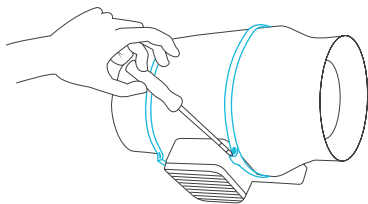

PROGRAMMING

FAN SPEED ADJUSTING

The controller features a single button that controls the fan speed from 0-10. Pressing the speed button increases the fan speed in one unit increments. Pressing the button at the 10 setting will set the fan speed back to 0.

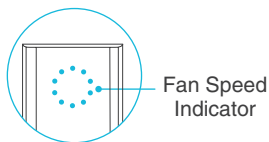
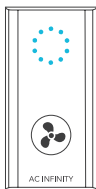

POWERING ON/OFF

Press the button to turn your fan on. Hold the button to turn your fan off. Pressing it again will turn the fan on at its last speed setting.

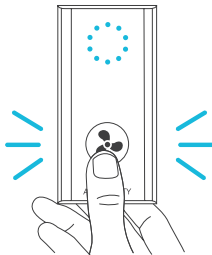

CLOUDLINE FAQ

Q: I am missing my controller. It wasn't included in my package!

A: Please refer to page 7 for an image of what your controller should look like. Your controller should be neatly slotted in the box by this product manual.

Q: Can I mount this inline duct fan vertically?

A: Yes. The CLOUDLINE can be mounted in any orientation, including vertically.

Q: Will I be able to hardwire this fan to my own controller or thermostat?

A: We do not recommend hardwiring or splicing our fan's power wires. Such modifications may compromise electrical safety and will void this product's warranty.

Q: Do I need to use a power converter if I'm outside the US?

A: This product's voltage range is 100-240V AC. You may need a simple travel adapter to plug it into a foreign socket, or a power converter if your country uses a different voltage.

Q: Does the controller retain its settings after power is shut off?

A: Yes. If the controller's power is cut off and is powered on afterwards, your settings will remain.

Q: What is the CFM of each of the different fan speeds?

A: Please refer to your CLOUDLINE model's product listing for its CFM specification.

CLOUDLINE FAQ

Q: I'm not getting enough airflow even after setting the fan speed to 10. What can I do?

A: Bends in ducting will reduce your fan's CFM performance. To retain airflow, you may straighten the ducting and eliminate as many bends as possible.

Q: Should I use this inline duct fan as an intake or an exhaust fan?

A: The CLOUDLINE is primarily used as an exhaust fan, but can be used as an intake fan as well. You may use this fan as an intake fan if you need fresh air into your space.

Q: Can I connect different sized fans to the same controller?

A: Please refer to page 26 for details on daisy chaining fans together.

Q: I'm hanging my fan upside down in my grow tent, can I rotate its motor box plate?

A: Yes. Use a screw driver to unscrew the motor cap. Rotate it to your desired orientation and reapply the screws.

AC INFINITY PRODUCTS

Advance Grow Tent

The CLOUDLAB series is a line of grow tents designed to create ideal growing conditions and facilitate indoor plant cultivation year-round. Features 2000D thick oxford canvas lined with inner diamond patterned mylar that maximizes grow light luminosity, and a reinforced frame with 150 lb. weight capacity.

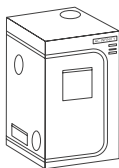

Seedling Mat

The SUNCORE series is a line of seedling mats designed to improve germination success rate by emitting a warming heat base. Utilizes even heating far-infrared film enveloped in flexible quad-layered PVC with IP-67 water-resistant rating. Features a knob controller that adjusts heat levels to meet unique seedling needs.

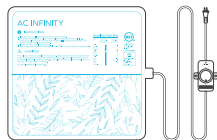

Duct Silencer

The duct silencer is designed to dampen fan and airflow noise travelling through ductwork. Made for use in inline duct applications such as HVAC, grow tents, server closets and more. Uses neoprene foam in egg crate formation to reduce noise by up to 50%.



WARRANTY

This warranty program is our commitment to you, the product sold by AC Infinity will be free from defects in manufacturing for a period of two years from the date of purchase. If a product is found to have a defect in material or workmanship, we will take the appropriate actions defined in this warranty to resolve any issues.

The warranty program applies to any order, purchase, receipt, or use of any products sold by AC Infinity or our authorized dealerships. The program covers products that have become defective, malfunctioned, or expressively if the product becomes unusable. The warranty program goes into effect on the date of purchase. The program will expire two years from the date of purchase. If your product becomes defective during that period, AC Infinity will replace your product with a new one or issue you a full refund.

The warranty program does not cover abuse or misuse. This includes physical damage, submersion of the product in water, incorrect Installation such as wrong voltage input, and misuse for any reason other than intended purposes. AC Infinity is not responsible for consequential loss or incidental damages of any nature caused by the product. We will not warrant damage from normal wear such as scratches and dings.

To initiate a product warranty claim, please contact our customer service team at support@acinfinity.com



If you have any issues with this product, contact us and we'll happily resolve your problem or issue a full refund

COPYRIGHT © 2021 AC INFINITY INC. ALL RIGHTS RESERVED

No part of the materials including graphics or logos available in this booklet may be copied, photocopied, reproduced, translated or reduced to any electronic medium or machine readable form, in whole or in part, without specific permission from AC Infinity Inc.

www.acinfinity.com