



WORX RACING YAMAHA STEERING STEM

PART # - WR06029

MODELS: All YAMAHA FZS/FZR Models

INSTALLATION INSTRUCTIONS

IMPORTANT: READ ALL INSTRUCTIONS BEFORE PROCEEDING WITH INSTALLATION

- 1- Make sure ski is secure and on a flat surface. Remove lanyard and disconnect battery.
- 2- Remove white locker plate from inside front storage compartment by depressing centre of plastic rivet to unlock and pull them out. **Pic 1**
- 3- Raise steering stem to maximum height. **Pic 2** Remove OEM bar pad by removing 5 screws (#1) with Philips screw driver. Remove OEM trigger by removing 2 socket screws (#2) with 4mm Allen wrench. Remove OEM start stop from handle bar by removing 2 Philips head screws (#3). Remove lone Philips screw from trim system (#4).
- 4- Remove end cap from handlebar on trim side by removing socket crew with 4mm Allen wrench **Pic 3**.
- 5- Remove handlebar clamps with 12mm socket and wrench. Slide bars to right to remove trim unit from handlebar **Pic 4 & 5**.
- 6- Unclip cable off ball joint on steering arm by sliding cover back. Leave cable in mounting bracket. Fold down tabs on plate securing locking bolt **Pic 6**. Remove bolt with 12mm socket and wrench (be careful not to drop nut into the hull as it is just sitting in it locating spot) **Pic 7**
- 7- Pull OEM arm down off stock steering stem. (Only remove metal steering arm at the bottom of the stem **NOT** the plastic arm above)
- 8- Lift OEM steering stem straight up to remove from ski. **Pic 8**
- 9- Remove OEM off throttle sensor from steering and fit to WORX steering stem. **Pic 9 & 10** **(Early model FZ has different sensors but will work with mounting points provided)**
- 10- Grease Pivot points on new stem. **Pic 11**. Fit WORX Steering stem into OEM location. Make sure OEM bush located in housing. **Pic 12**.
- 11- Make sure bottom bush **Pic 14** is located into correct position before fitting bottom steering arm **Pic 13**.
- 12- Bottom OEM steering arm will locate onto new WORX stem same as OEM. Fit bottom steering arm to steering stem by pushing up onto keyed section. The OEM bolt should fit thru the cut away section same as OEM. Secure with OEM bolt and Nut. Remember to use locking plate. Once bolt is tight fold up tabs to secure bolt. **Pic 16**
- 13- Re-attach steering cable to ball joint on steering arm. Check steering operation is correct and movement is free. Steering alignment will be the same as OEM so if it was correct before it will not need any adjustment.
- 14- Refit front locker plate with OEM plastic rivets. You are now able to fit 7/8 handlebars of your choice and attach all handle bar controls.
- 15- Once bars are fitted. Reconnect battery. **Fully check for correct Steering operation before use.**

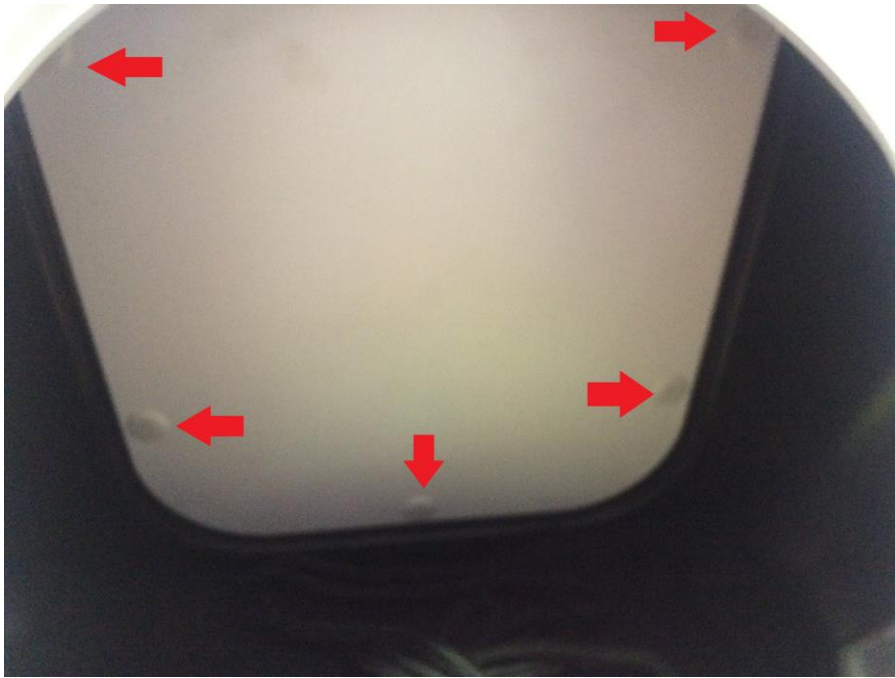

Pic 1



Pic 2

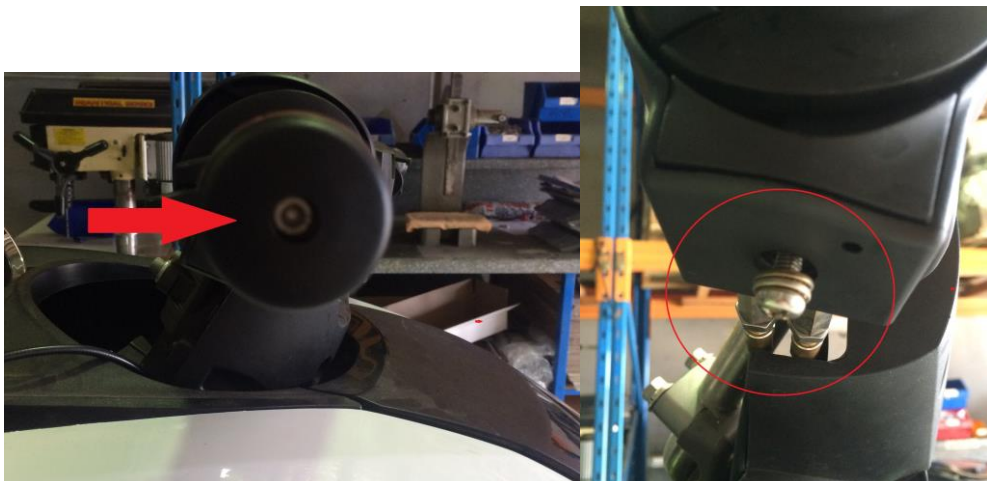

Pic 3

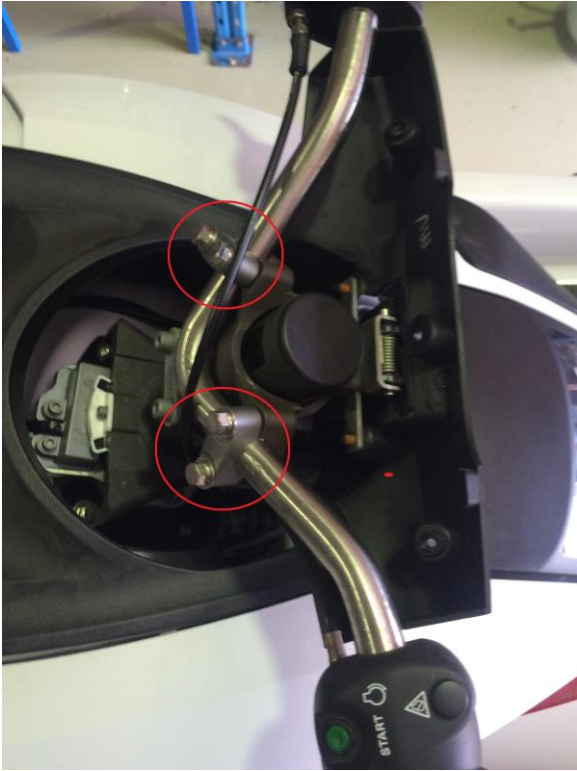

Pic 4

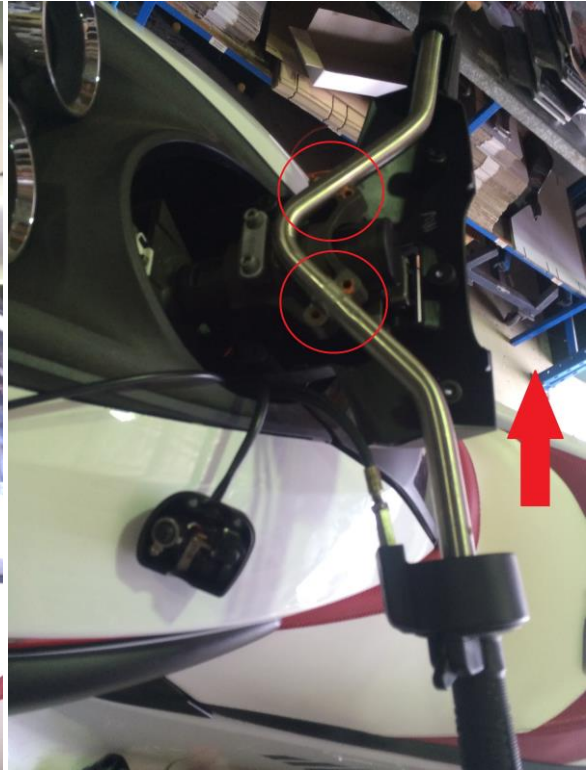

Pic 5

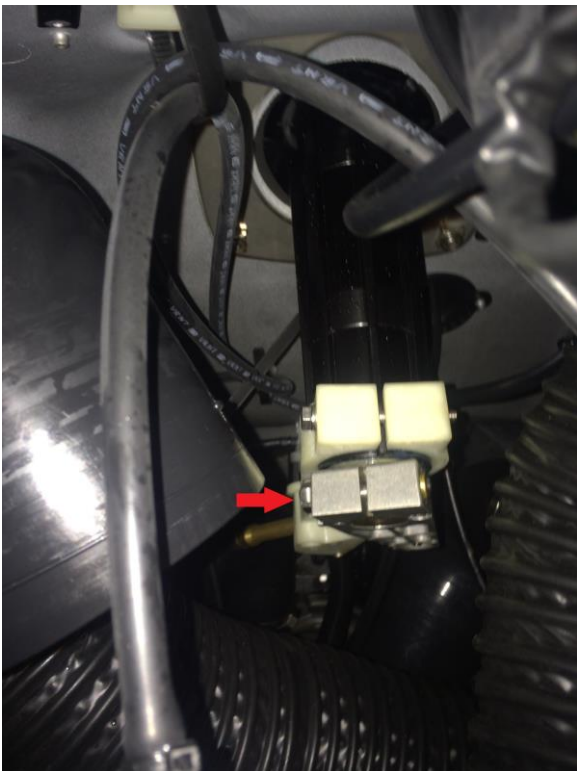

Pic 6

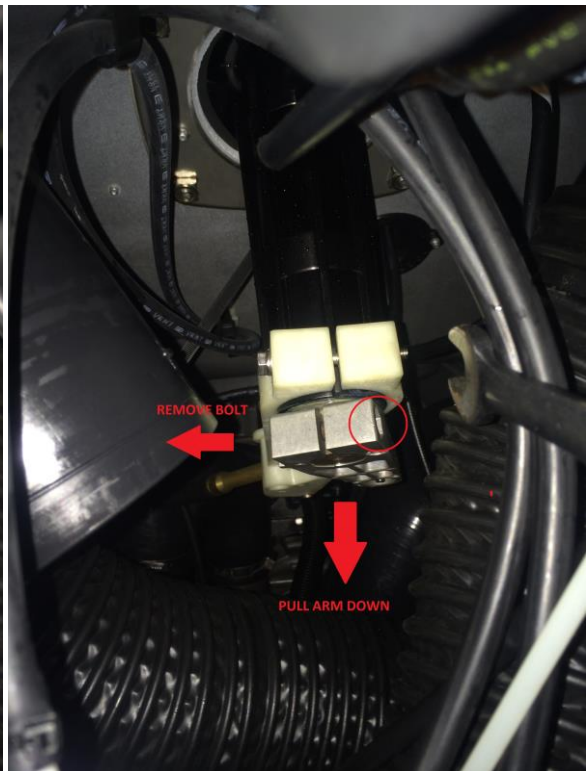

Pic 7



Pic 8

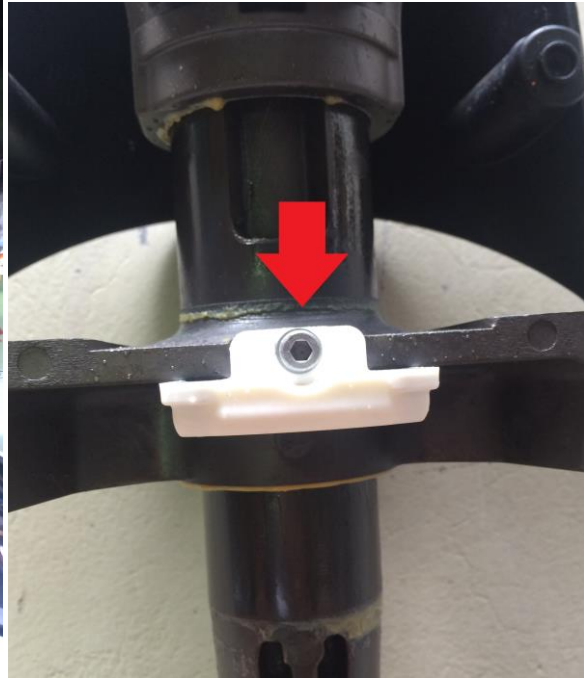

Pic 9



Pic 10

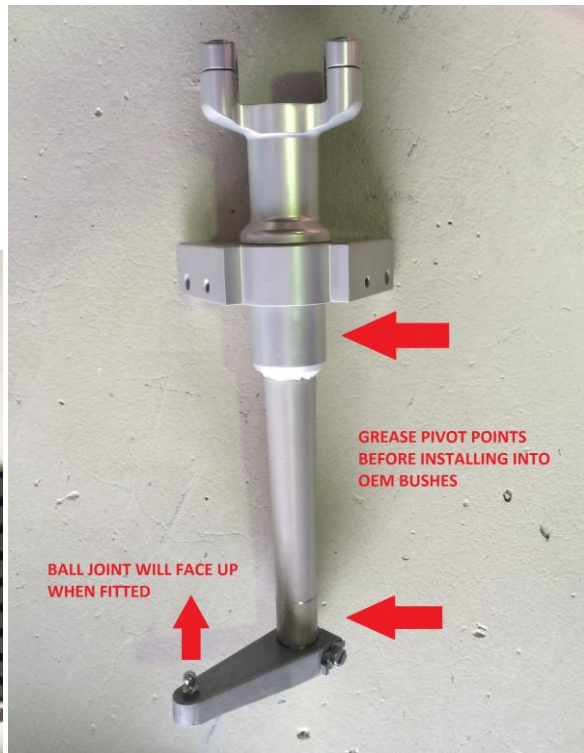

Pic 11

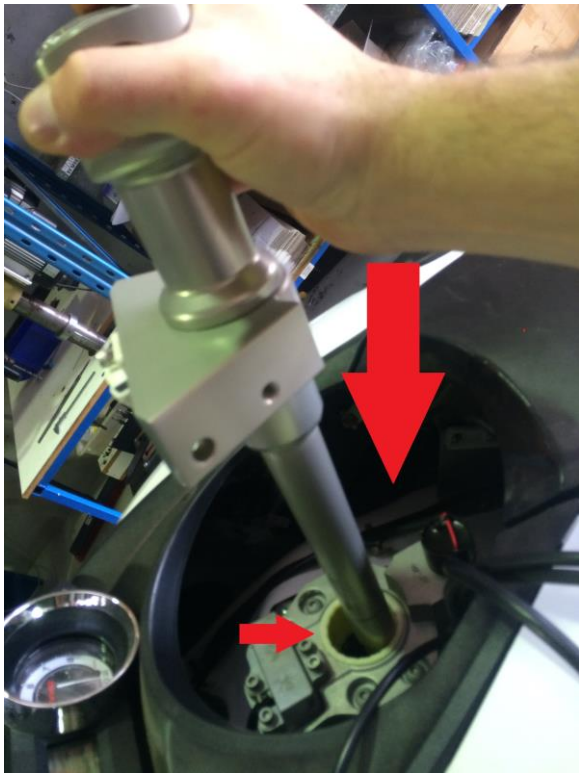

Pic 12

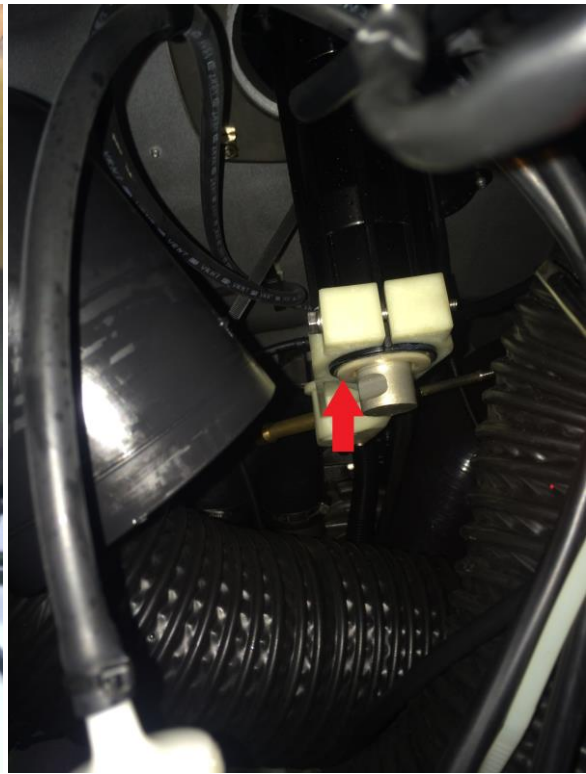

Pic 13



Pic 14

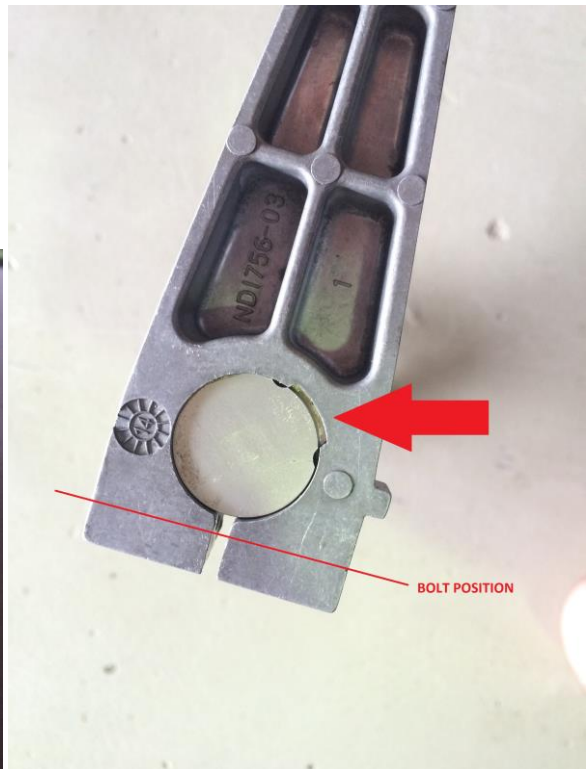

Pic 15

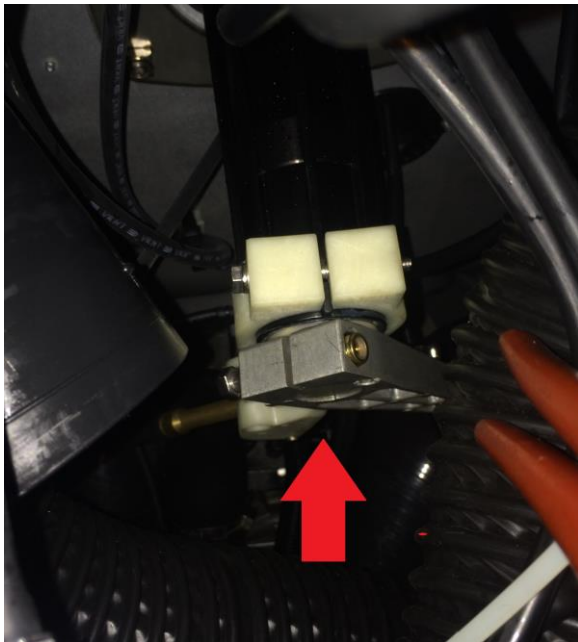

Pic 16

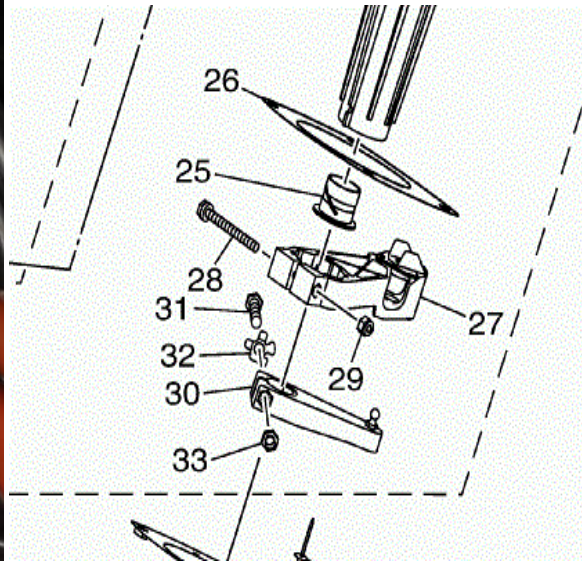

Pic 17



Thank you for purchasing **Worx Racing components** products. We firmly believe that **Worx Racing Components** products are among the finest watercraft parts available. A great deal of time and effort has gone into the design and development of this product to ensure that it will perform to the highest standard and that installation is a relatively straight forward and simple procedure. If you have any questions or comments on the performance and/or installation of our products please contact us at the numbers listed on page one or through your local **Worx** dealer.

8B 354 Brisbane Rd Arundel QLD 4214 Phone: +61 7 5563 1031

www.worx.com.au / info@worx.com.au