

# madeo PLANE

## STARTER GUIDES

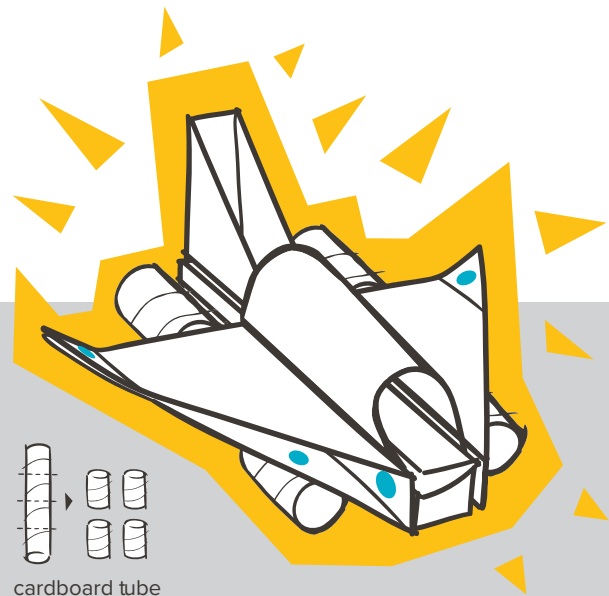

USE:

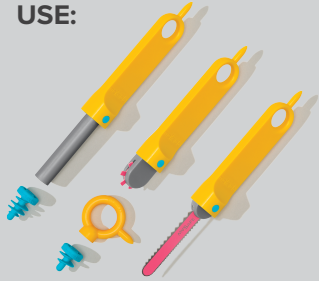

FIND:

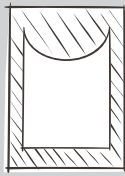

card

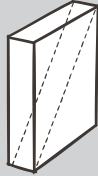

cereal box

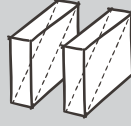

cookie box

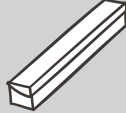

foil box

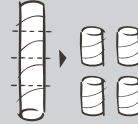

cardboard tube

MAKEDO:

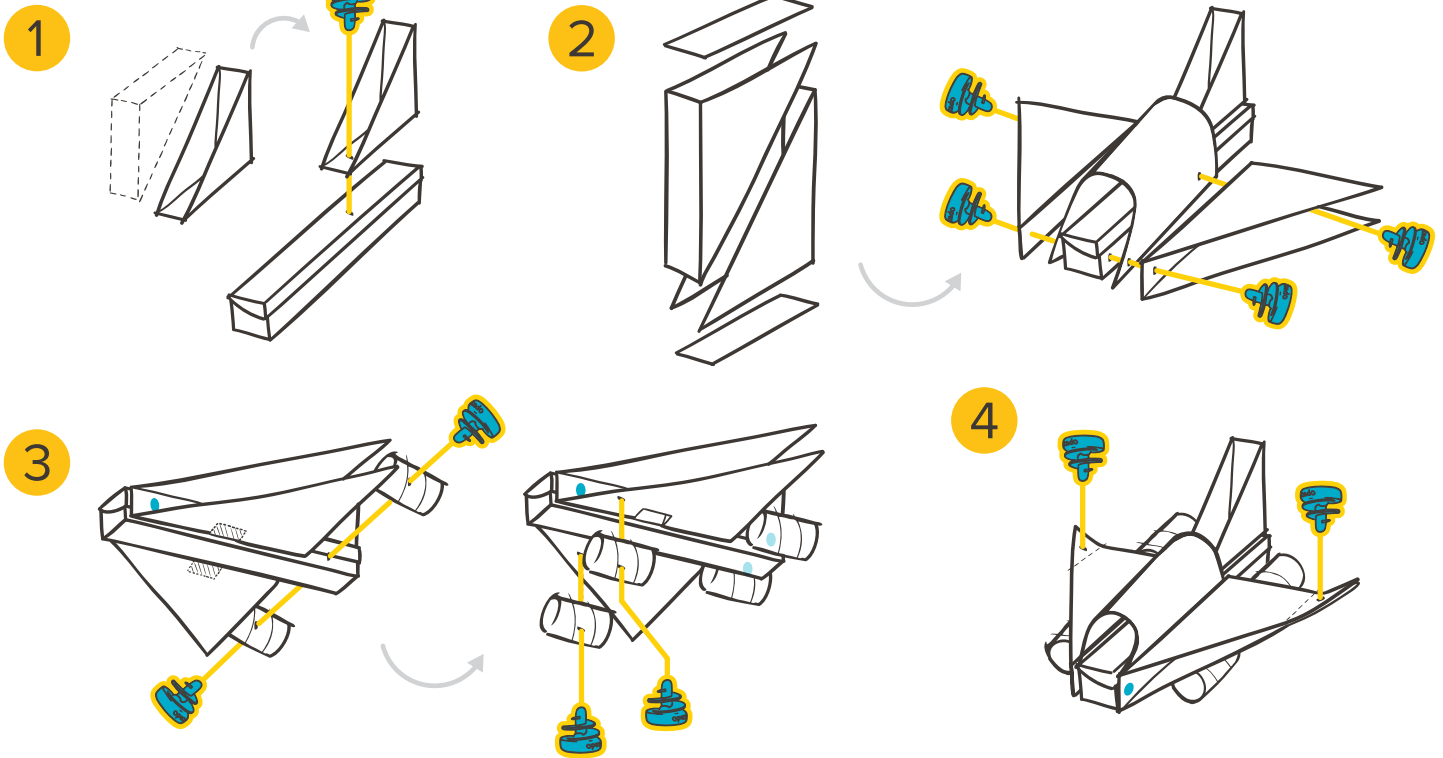

When making and learning with Makedo, students can be supported to use ideas from science, technology, engineering, mathematics and the arts to develop their skills in 21st century thinking – often known as the 4 C's, which are:

### CRITICAL THINKING

Ask questions, evaluate and make decisions by exploring various ideas, applied to making.

### CREATIVE THINKING

Develop unique ideas and innovative ways of solving problems. Have a go at thinking outside the box.

### COLLABORATION

Work with a group to achieve a shared goal and create something together.

### COMMUNICATION

Listen to, and share questions and ideas, with a team.

5+

