

**Professional**

**SOVIS**

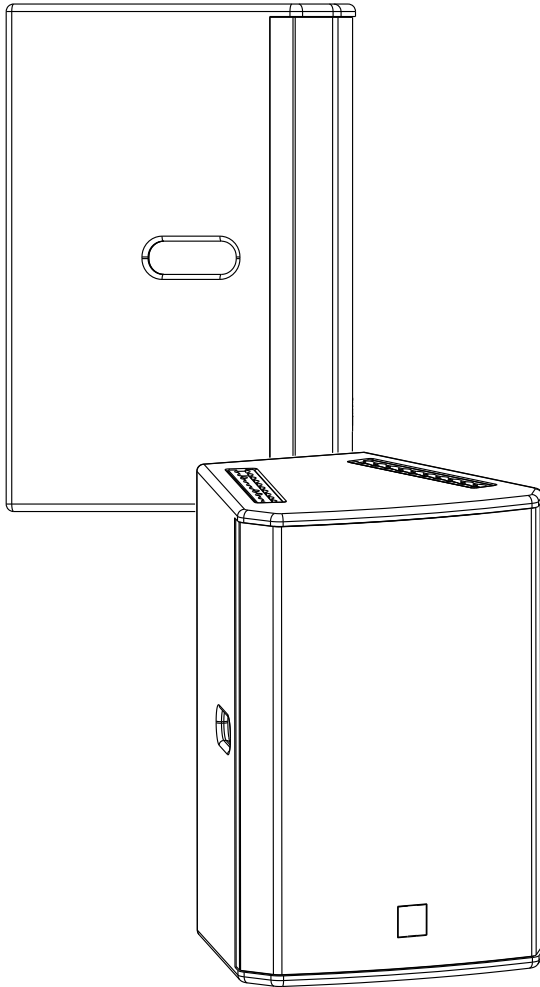

**TS115B**

**15" Two Way Full Range  
Speaker With Built-in Crossover**

**User Manual**





UM-TS115B-20181218 ver A



# SAFETY INSTRUCTIONS

## PLEASE READ THIS MANUAL FIRST

Thank you for buying **SOVIS** product. Read this manual first as it will help you operate the system properly. Please keep this manual for future reference.

**⚠ WARNING:** *This product must be installed by professionals. When using hanging brackets or rigging other than those supplied with the product, please ensure they comply with the local safety codes.*

	<b>CAUTION</b> RISK OF ELECTRICAL SHOCK DO NOT OPEN	
CAUTION: TO REDUCE THE RISK OF ELECTRIC SHOCK, DO NOT REMOVE COVER (OR BACK). NO USER-SERVICABLE PARTS INSIDE. REFER SERVICING TO QUALIFIED PERSONNEL.		

	<b>AVIS</b> RISQUE DE CHOC ÉLECTRIQUE NE PAS OUVRIR	
ATTENTION : POUR RÉDUIRE LE RISQUE DE DÉCHARGE ÉLECTRIQUE, NE RETIREZ PAS LE COUVERCLE (OU L'ARRIÈRE). IL NE SE TROUVE À L'INTÉRIEUR AUCUNE PIÈCE POUVANT ÊTRE RÉPARÉE PAR L'USAGER. S'ADRESSER À UN RÉPARATEUR COMPÉTENT.		



*The exclamation point within an equilateral triangle is intended to alert you to the presence of important operating and servicing instructions.*

**⚠ ATTENTION:** *Don't refit the system or spare parts without being authorized as this will void the warranty.*

**⚠ WARNING:** *Don't place naked flames (such as candles) close to the equipment.*

1. Read the instruction manual first before using this product.
2. Please keep this manual for future reference
3. Pay attention to all warnings.
4. Obey all operating instructions.
5. Do not expose this product to rain or moisture.
6. Clean this equipment with a dry cloth.
7. Do not block any ventilation openings. Install according to manufacturer's instructions .
8. Do not install this product near any heat source, such as a, heater, burner, or any other equipment with heat radiation .
9. Only use spare parts supplied by the manufacturer.
10. Pay attention to the safety symbol on the outside of the cover.

**CONTENT**

**INTRODUCTION** ..... 3

    Features ..... 3

    Description ..... 3

    Applications ..... 3

**CONNECTION** ..... 4

    Terminal Plate ..... 4

    NL4 Connection ..... 4

    System Connection Reference ..... 4

    Loudspeaker Connection ..... 5

**INSTALLATION** ..... 6

    Mounting Accessories ..... 6

    Installation Reference ..... 6

**TECHNICAL SPECIFICATION** ..... 7

    Technical Sheet ..... 7

    Frequency Response And Impedance Curve ..... 7

    2D Dimension ..... 8

 Product information is subject to change without prior notification.

## TS115B

15" Two Way Full Range Speaker With Built-in Crossover

### Features

- Two way full range phase inverted speaker with 15" woofer and 3" compression driver.
- Dispersion 60°x40°.
- Advanced tweeter protection assures reliability.
- Sensitivity 98dB, Max.SPL 124dB.
- Rated power 360W, peak power 1440W.
- Adjustable flying track on the top and bottom of speaker.
- Powder coated grill with foam backing.
- Durable Polyurethane textured base paint.

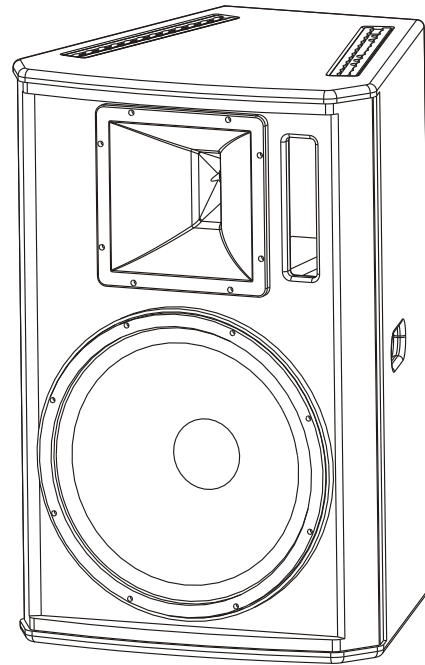

### Description

TS115B is a two way full range speaker. It integrates one 15" Neodymium woofer and one 3" compression driver. The rated power is 360W, the peak power is 1440W.

Cabinet is made of 15mm birch plywood with advanced environmental protection Polyurethane-based painting which is very rigid. Powder coated grill with foam backing

TS115B is mainly designed for conference room, multifunctional hall, auditorium, church, live performance.

### Applications

- Church
- Small Auditorium
- Conference room
- Small performance
- Multifunctional hall

Two NL4 connectors are available for amplifier connection. The parallel connector is convenient for connecting to another speaker.

**Terminal Plate**

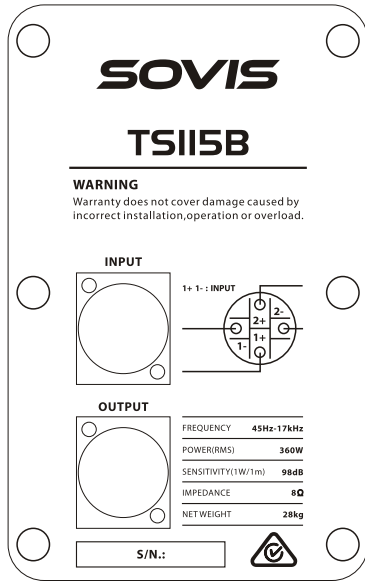

1+ 1- INPUT

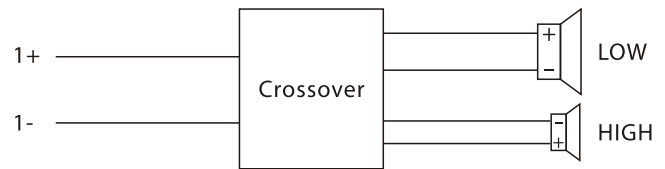

**NL4 Connection**

1. Connect

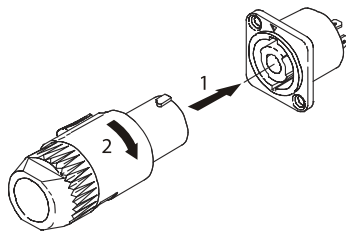

2. Disconnect

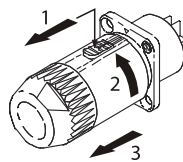

**System Connection Reference**

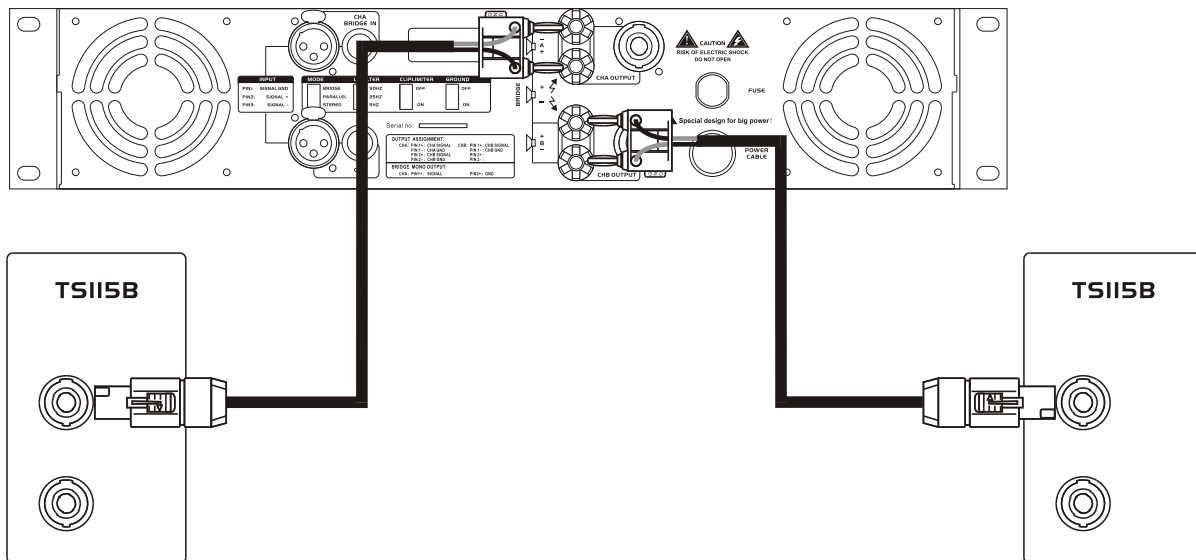

- ⚠ Attention:** The impedance of connected speaker must match the impedance of amplifier output.
- ⚠ Attention:** Make sure the polarity of speaker and amplifier are correct..

**Speaker Wiring**

1. Banana plugs to NL4

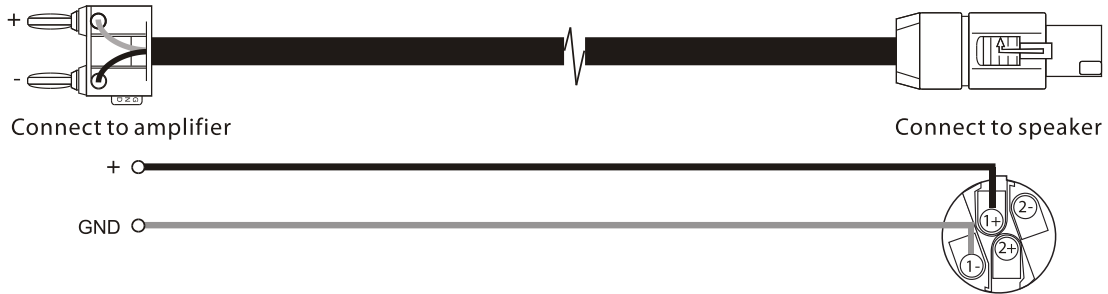

2. NL4 to NL4

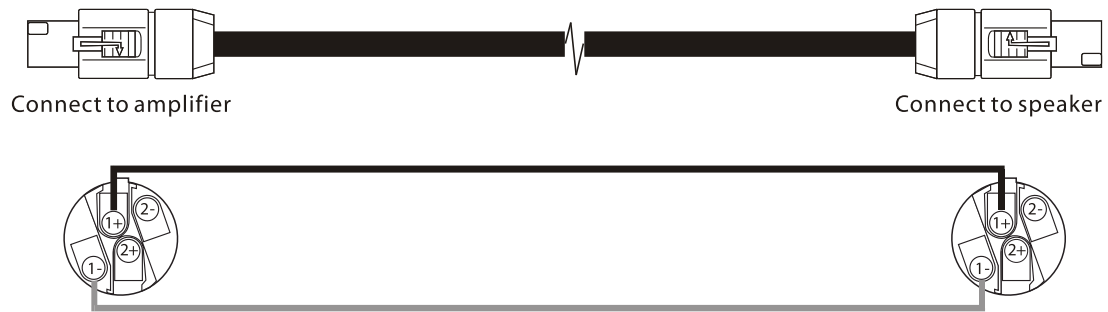

### Mounting Accessories

The standard flying mounting hardware is convenient for different installations and applications.

1. Speaker stand  
SPS-502BC black



2. Standard flying mounting ring



**⚠ Warning:** Make sure the mounting accessories safety factor not less than 5:1 or meet the local standard during installation .

### Installation Reference

1. Vertical flying mounting installation

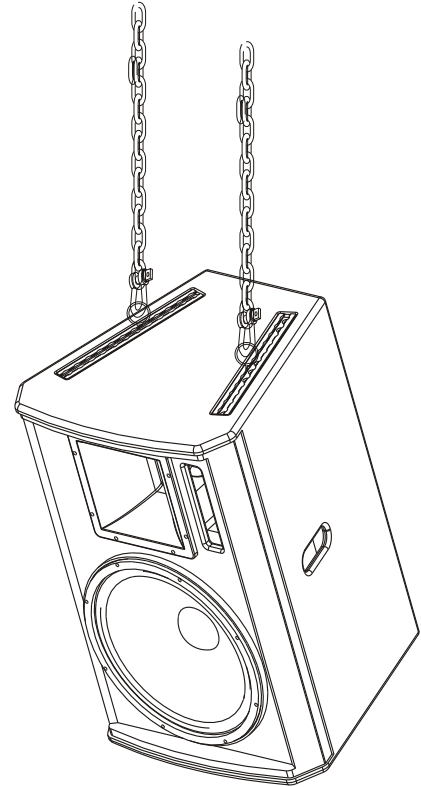

2. Horizontal flying mounting installation

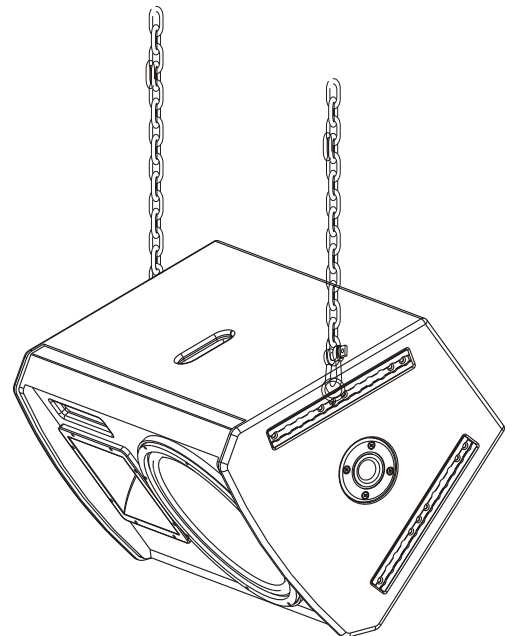

**Technical Specification**

System:	Passive full range wooden speaker
Tweeter:	1 × 3" compression driver
Woofer:	1 × 15" Neodymium woofer
Frequency response(-3dB) <sup>1</sup> :	45Hz-17kHz
Frequency response(-10dB):	35Hz-20kHz
Sensitivity(1W@1m) <sup>2</sup> :	98dB
Max. SPL(1m) <sup>3</sup> :	124dB/130dB(PEAK)
Power:	360W (RMS) <sup>4</sup> 720W (MUSIC) 1440W (PEAK)
Dispersion ( H × V ) :	60° × 40°
Rated impedance:	8 Ohms
Crossover point:	1.7kHz
Cabinet:	Wedge shape
Mounting accessories:	Standard flying mounting hardware
Handle:	2 × Wooden handle
Painting:	Cabinet coated by Polyurethane paint; grille is powder coated
Connector:	NL4 × 2
Cabinet dimension:	485 × 485 × 720mm (W × D × H) (19.1 × 19.1 × 28.4in)
Package dimension:	600 × 600 × 845mm (W × D × H) (23.6 × 23.6 × 33.3in)
Net weight(pc):	28.0kg(61.6 lb)
Gross weight(pc):	32.5kg(71.5 lb)
Optional mounting accessories:	Flying mounting ring, speaker stand

**Speaker Testing Method**

**1. Frequency Response**

Use Pink noise to test the speaker in the anechoic chamber, adjust the level to make the speaker work at its rated impedance and set the output power at 1W, then test the frequency response 1m away from the speaker.

**2. Sensitivity**

Use full range Pink noise which has been modified using an EQ curve to test the speaker in the anechoic chamber, increasing the signal to make the speaker work at its rated impedance and set the power output at 1W, then test the sensitivity 1m away from the speaker.

**3. MAX.SPL**

Use full range Pink noise which has been modified using an EQ curve to test the speaker in the anechoic chamber, increase the signal to make the speaker work at its maximum power output level, then test the SPL 1m away from the speaker.

**4. Rated Power**

Use Pink noise to the IEC#268-5 standard to test the speaker, increase the signal for a continuous period of 100 hours, the rated power is the power when the speaker will show no visible or measurable damage.

**Frequency response curve & Impedance curve**

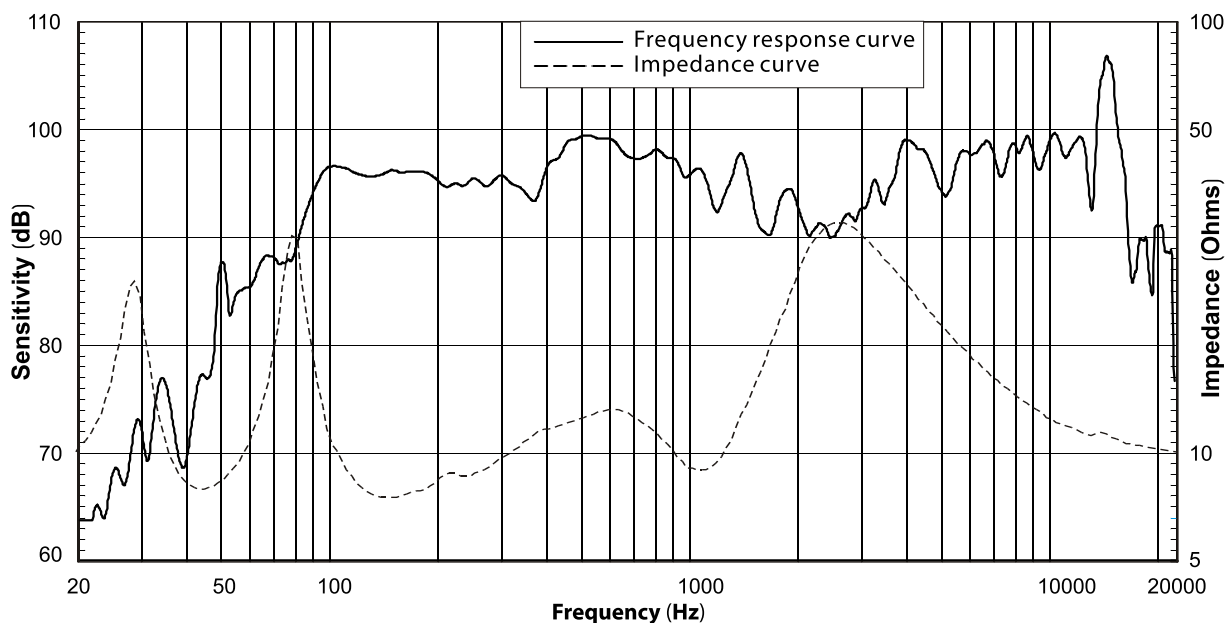



**2D Dimension**

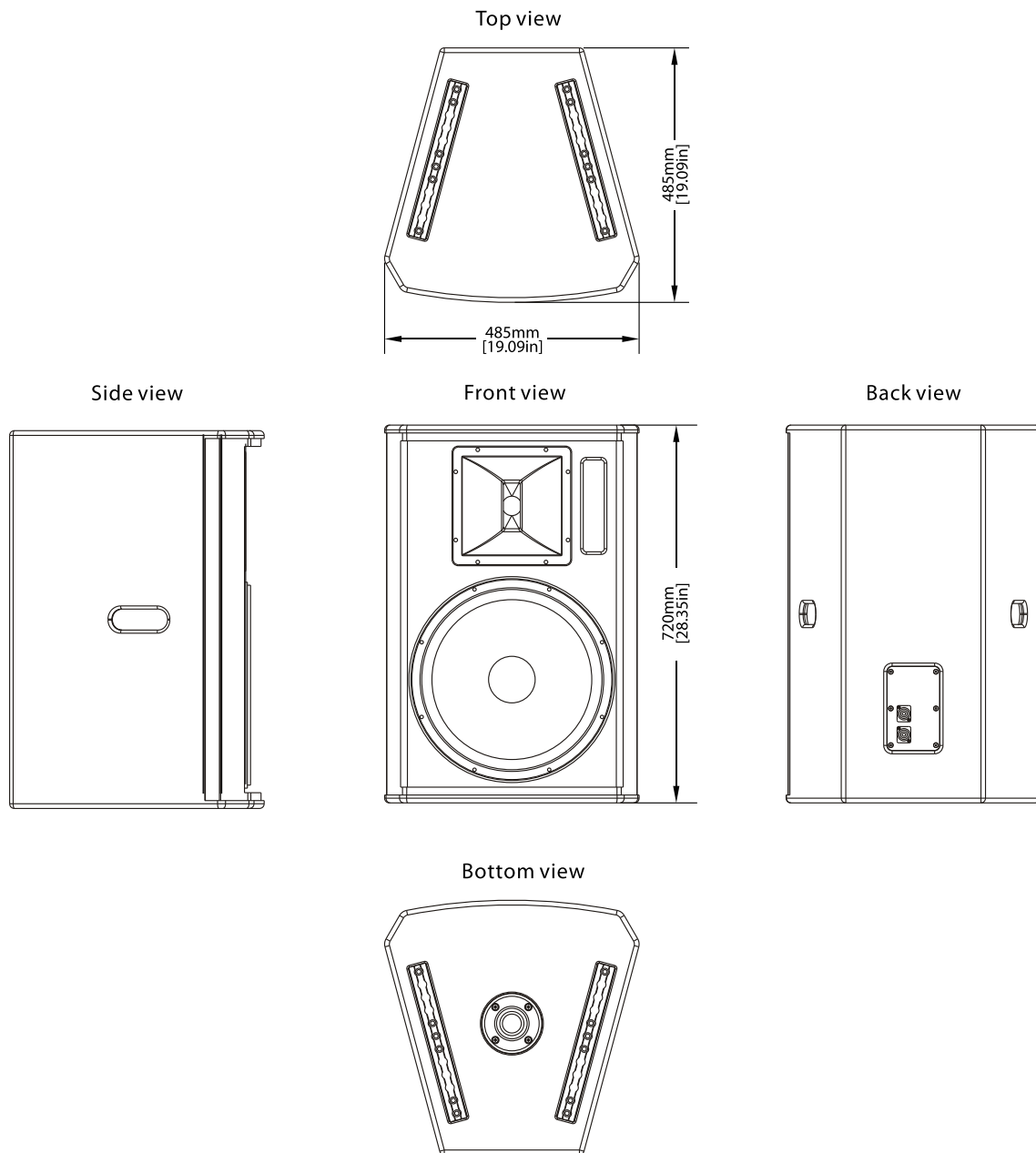

**Notes:**

**SOVIS**

[www.sovis.com.sg](http://www.sovis.com.sg)