

USB Table Top LED Light Kit
Instruction Manual

Copyright

© 2020 Shenzhen Neeer Technology Co., Ltd. All Rights Reserved.
This document is the sole property of Shenzhen Neeer Technology Co., Ltd and shall not be, reproduced, transmitted, transcribed, stored in a retrieval system or translated in any form, by any means, without prior written permission from Shenzhen Neeer Technology Co., Ltd. Shenzhen Neeer Technology Co., Ltd reserves the right to change content in this instruction manual at any time and without prior notice.

Version Control

Date	Version number	Description	Issued by
12/04/2020	1.0	2 x USB LED Tabletop Light Kit Manual	NEEWER

English -----1
 Français ----- 6
 Deutsch -----11
 日本語 -----16
 Italiano -----21
 Español ----- 26
 Nederlands ----- 31
 中文 -----36

Product Overview

The USB desktop LED light set is an auxiliary lighting product used for photography. The light panel features 66 dimmable energy-saving LED bulbs, providing exceptional lighting. Supplied with white, red, yellow, and blue color gel filters, the height-adjustable light stand effectively meets the needs for various types of shooting.



Photo shooting

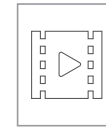

video recording

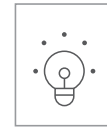

conventional lighting

Packing list

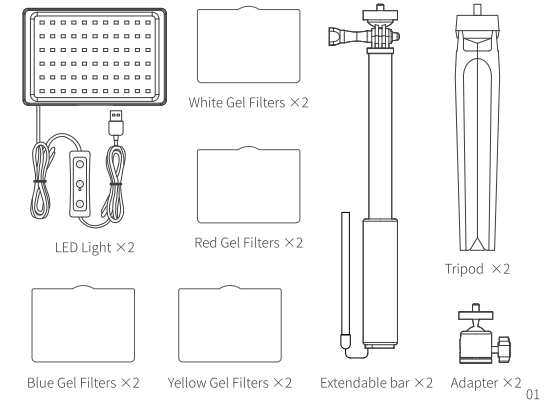

Installation instructions

1. Set up the tripod and extendable column.

- ① Rotate the tripod anticlockwise into the 1/4 screw hole at the base of the extendable column.
- ② Pull out the extendable column, adjust to an appropriate height and rotate it clockwise to secure.

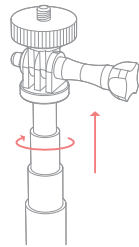
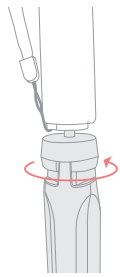

- ③ Re-position the three tripod legs.

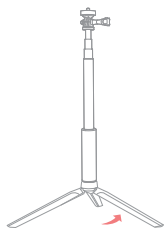

- ④ Turn the knob to adjust the angle of the connecting bracket at the top of the extended column.

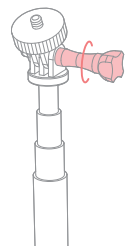

Installation instructions

2. Mount the LED Light

- ① Mount the support bracket on the LED panel light by rotating it in a counterclockwise direction. Attach the extended column to the supporting bracket by rotating it anti-clockwise.
- ② Remove the transparent film from the color filter.

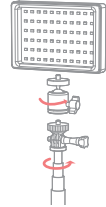

- ③ Insert the color gel filter into the LED panel by sliding from the top to the bottom of light head.

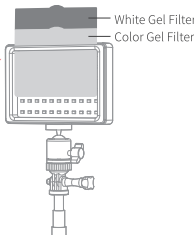

- ④ Set the angle of LED light by adjusting the adapter's turn knob.

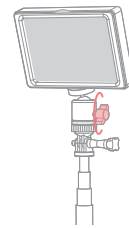

* Red, blue and yellow filters should be used together with the white filter.

Instructions

1. Power on the LED

Connect the USB plug to the 5V/2A power supply. The Power On/OFF indicator should light up blue.

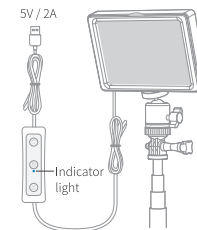

2. Turn the LED light on/off

Press the power on/off button to turn the LED light on or off. Once the LED light is turned on, the indicator light will go out.

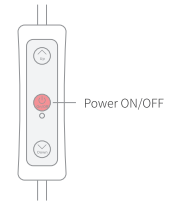

3. Increase brightness levels

Press the "UP" key once to increase the brightness of the LED by 10%. Long press the up key to increase the brightness output to 100%.

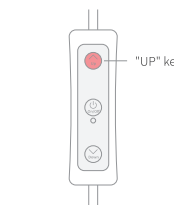

4. Reduce the brightness level

Press the "DOWN" key once to decrease the brightness of the LED by 10%. Long press the "DOWN" key to decrease the brightness output to 10%.

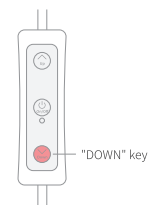

Note: This LED light is designed with circuit protection to protect the light with maximum input voltage set to be 5V.

If the light cannot be turned on and the indicator on the controller starts blinking blue, it means the input voltage exceeds 5V. To make the light work properly, please choose the right voltage.

General Safety Notes

- Please do not store the product in an environment where temperatures exceed 40°C.
- Please do not stare at the light directly during use to reduce the risk of visual impairment.
- Please do not store the product in an environment with inflammable or volatile substances
- Please do not use the product in the rain or in a humid environment.
- Please disconnect the power source when not in use.
- Do not use alcohol or liquid to wipe the light to avoid damage.
- If you don't intend to use the product for a long period of time, please ensure the product is kept in a dry and well-ventilated environment. Keep away from hot or magnetic fields.
- Failure to follow operation procedures and warnings listed in the manual will void the warranty.

Product Specifications

Size	142×97×20mm
Lumens	1000LM
LED	66PCS
Output Power	10W
Color Temperature	5600K
Dimmer	10%-100%
Power input	USB 5V / 2A

Aperçu du produit

FR L'ensemble de panneaux LED USB pour bureau est un produit d'éclairage auxiliaire utilisé pour la photographie. Chaque panneau lumineux comporte 66 ampoules LED à économie d'énergie à intensité variable, capable d'un éclairage exceptionnel. Muni de filtres gel de couleur (blanc, rouge, jaune et bleu) ainsi qu'un pied d'éclairage qui répond parfaitement aux besoins de différents types de prises de vue.



Photo portrait

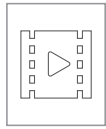

Enregistrement vidéo

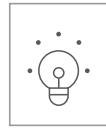

Éclairage conventionnel

Accessoires inclus

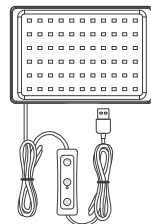

Lumière LED ×2



Filtres à gel blanc ×2



Filtres à gel rouge ×2



Filtres à gel bleu ×2



Filtres à gel jaune ×2

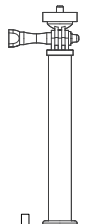

Barre extensible ×2

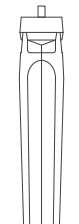

Trépied ×2



Adaptateur ×2

06

Installation

1. Installation du trépied et de la barre extensible.

FR

① Tournez le trépied dans le sens inverse des aiguilles d'une montre dans le trou de vis 1/4 situé à la base de la barre extensible.

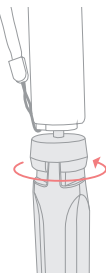

③ Repositionnez les trois pieds du trépied.

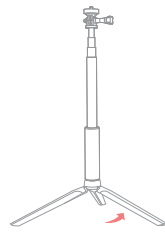

② Retirez la barre extensible, réglez-la à une hauteur appropriée et tournez-la dans le sens des aiguilles d'une montre pour serrer.

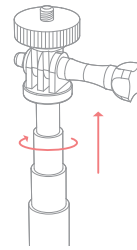

④ Tournez le bouton indiqué pour régler l'angle du support.

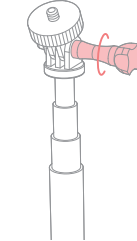

07

Installation

2. Montage de la lumière LED

FR

① Montez le support sur le panneau LED en le faisant tourner dans le sens inverse des aiguilles d'une montre. Fixez la barre d'extension sur le support en la faisant tourner dans le sens inverse des aiguilles d'une montre.

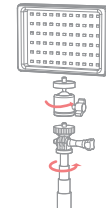

③ Insérez un des filtres de couleur dans le panneau LED en le faisant glisser du haut vers le bas comme indiqué.

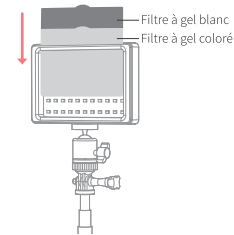

② Retirez la couche de protection du filtre de couleur.

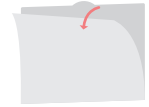

④ Réglez l'angle de la lumière LED en ajustant le bouton rotatif de l'adaptateur.

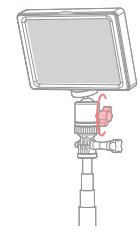

* Les filtres rouge, bleu et jaune doivent être utilisés en même temps que le filtre blanc.

08

Instructions

1. Mettez le panneau LED sous tension

Branchez la prise USB sur l'alimentation 5V/2A. Le témoin lumineux de mise en marche / arrêt tension s'allume en bleu.

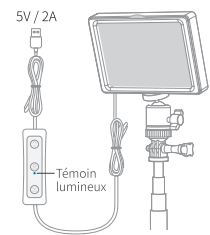

2. Allumer/éteindre la lumière LED

Appuyez sur le bouton marche/arrêt pour allumer ou éteindre la lumière LED. Une fois que la lumière LED est allumée, le témoin lumineux s'éteint.



3. Augmentez le niveau de luminosité

Appuyez une fois sur le bouton "UP" pour augmenter la luminosité de la LED de 10%. Appuyez longuement sur le bouton "UP" pour augmenter la luminosité de la LED à 100%.

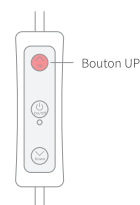

4. Diminuer le niveau de luminosité

Appuyez une fois sur le bouton "DOWN" pour diminuer la luminosité de la LED de 10%. Appuyez longuement sur le bouton "DOWN" pour réduire la luminosité de la LED à 10%.

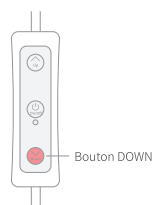

* Cette lumière LED a un dispositif de protection contre les surtensions pour protéger la lumière. La tension d'entrée maximale est fixée à 5V.

Si vous n'arrivez pas à allumer la lumière et que l'indicateur du contrôleur se met à clignoter en bleu, cela indique que la tension d'entrée a dépassé 5V. Pour que la lumière fonctionne correctement, veuillez vous assurer que la tension utilisée est correcte.

09

Pour votre sécurité

FR

- Veuillez ne pas stocker le produit dans un environnement où la température dépasse 40°C.
- Veuillez ne pas fixer la lumière directement pendant l'utilisation afin de réduire le risque de déficience visuelle.
- Veuillez ne pas entreposer le produit dans un environnement contenant des substances inflammables ou volatiles.
- Veuillez ne pas utiliser le produit sous la pluie ou dans un environnement humide.
- Veuillez débrancher la source d'alimentation lorsque vous ne l'utilisez pas.
- N'utilisez pas d'alcool ou de liquide pour essuyer la lumière afin d'éviter de l'endommager.
- Si vous n'avez pas l'intention d'utiliser le produit pendant une longue période, veuillez vous assurer que le produit est conservé dans un environnement sec et bien ventilé. Tenez-le à l'écart des champs chauds ou magnétiques.
- Le non-respect des procédures d'utilisation et des avertissements figurant dans le manuel annule la garantie.

Spécifications du produit

Taille	142×97×20mm
Lumens	1000LM
LED	66PCS
Puissance de sortie	10W
Température de couleur	5600K
Dimmer	10%~100%
Puissance d'entrée	USB 5V / 2A

10

Produktübersicht

Das USB Tisch LED Lichtset ist ein zusätzliches Beleuchtungsprodukt für die Fotografie. Das Lichtpaneel verfügt über 66 dimmbare energiesparende LED-Lampen, die für außergewöhnliche Beleuchtung sorgen. Ausgestattet mit weißen, roten, gelben und blauen Farbfiltern ausserdem erfüllt das höhenverstellbare Lichtstativ effektiv die Anforderungen für verschiedene Arten von Aufnahmen

DE



Fotografieren

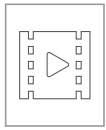

Videoaufnahmen

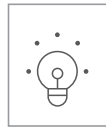

konventionelle Beleuchtung

Packungsinhalt

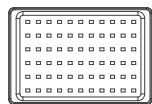

Adapter × 2

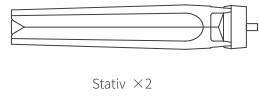

Stativ × 2

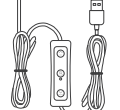

LED-Licht × 2

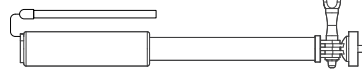

Verlängerungsstange × 2



Blaue Gelfilter × 2



Gelbe Gelfilter × 2



Rote Gelfilter × 2



Weisse Gelfilter × 2

11

Installationsanleitung

1. Installation des Stativs und Verlängerungsstange.

DE

① Drehen Sie das Stativ gegen den Uhrzeigersinn in das 1/4 Schraubenloch an der Unterseite der Verlängerungsstange.

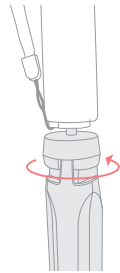

③ Stellen Sie die drei Beine des Stativs auf.

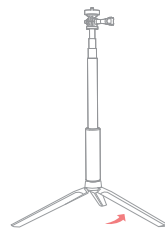

12

② Ziehen Sie die Verlängerungsstange heraus, stellen Sie sie auf eine geeignete Höhe ein und drehen Sie sie im Uhrzeigersinn, um sie zu verriegeln.

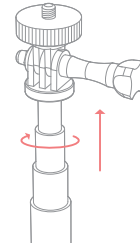

④ Drehen Sie den Knopf, um den Ausrichtungswinkel des Steckers oben auf der Verlängerungsstange einzustellen.

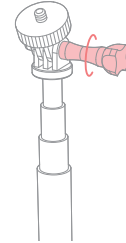

Installationsanleitung

2. Montage des LED-Lichts

① Drehen Sie den Adapter gegen den Uhrzeigersinn und installieren Sie ihn auf dem LED-Lichtpaneel. Drehen Sie die Verlängerungsstange gegen den Uhrzeigersinn und bringen Sie sie am Adapter an.

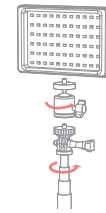

③ Setzen Sie den Farbfilter von oben nach unten in das LED-Panel ein.

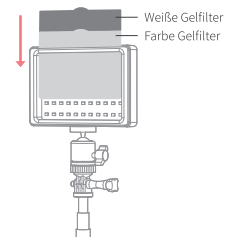

* Rot-, Blau- und Gelbfilter sollten zusammen mit dem Weißfilter verwendet werden.

② Reißen Sie den transparenten Film auf dem Farbfilter ab.



④ Stellen Sie den Winkel des LED-Lichts ein, indem Sie den Drehknopf des Adapters einstellen.

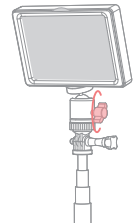

13

Anleitung

DE

1. LED-Lampen einschalten

Schließen Sie den USB-Stecker an das 5V/2A-Netzteil an. Die Betriebsanzeige EIN/AUS leuchtet normalerweise blau.

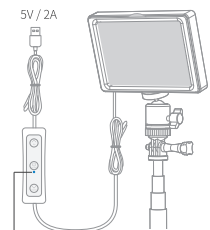

Kontrollleuchte

2. Schalten Sie die LED ein / aus

Drücken Sie die Ein-/ Aus-Taste, um das LED-Licht ein- oder auszuschalten. Sobald die LED leuchtet, erlischt die Anzeigelampe.



Einschalten / Ausschalten

3. Erhöhen Sie die Helligkeit

Drücken Sie einmal die Taste "nach oben", um die Helligkeit der LED um 10% zu erhöhen. Drücken Sie lange die Aufwärts-Taste, um die Helligkeitsausgabe auf 100% zu erhöhen.



Taste "nach oben"

4. Reduzieren Sie die Helligkeit

Drücken Sie einmal die Taste "nach unten", um die Helligkeit der LED um 10% zu verringern. Drücken Sie lange die Taste "nach unten", um die Helligkeitsausgabe auf 10% zu verringern.



Taste "nach unten"

* Dieses LED-Licht ist mit einem Stromkreisschutz ausgestattet, um das Licht mit einer maximalen Eingangsspannung von 5V zu schützen.

Wenn das Licht nicht eingeschaltet werden kann und die Anzeige am Controller blau zu blinken beginnt, bedeutet dies, dass die Eingangsspannung 5V überschreitet. Damit das Licht richtig funktioniert, wählen Sie bitte die richtige Spannung.

14

Allgemeine Sicherheitshinweise

DE

- Bitte lagern Sie das Produkt nicht in einer Umgebung, in der die Temperaturen 40°C überschreiten.
- Bitte starren Sie während des Gebrauchs nicht direkt auf das Licht, um das Risiko einer Sehbehinderung zu verringern.
- Bitte lagern Sie das Produkt nicht in einer Umgebung mit brennbaren oder flüssigen Substanzen
- Bitte verwenden Sie das Produkt nicht im Regen oder in feuchter Umgebung.
- Bitte trennen Sie die Stromquelle, wenn Sie sie nicht verwenden.
- Verwenden Sie keinen Alkohol oder keine Flüssigkeit, um das Licht abzuwischen, um Schäden zu vermeiden.
- Wenn Sie das Produkt nicht über einen längeren Zeitraum verwenden möchten, stellen Sie bitte sicher, dass das Produkt in einer trockenen und gut belüfteten Umgebung aufbewahrt wird. Von heißen oder magnetischen Feldern fernhalten.
- Die Nichtbeachtung der im Handbuch aufgeführten Betriebsverfahren und Warnungen führt zum Erlöschen der Garantie.

Produktspezifikationen

'Größe	142×97×20mm
Lumen	1000LM
LED	66PCS
Ausgangsleistung	10W
Farbtemperatur	5600K
Dimmer	10%~100%
Stromeingang	USB 5V / 2A

15

製品概要

USB卓上LEDライトセットは、写真撮影に使用される補助照明製品です。ライトパネルは、66個の調光可能な省エネLED電球を備えており、優れた照明を提供します。白、赤、黄、青のカラージェルフィルターと高さ調節可能なライトスタンドが付属され、さまざまな撮影ニーズに効果的に応えます。

JP



写真撮影

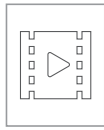

ビデオ録画

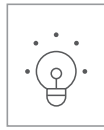

照明

製品を確認してください

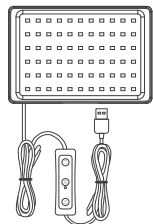

LEDライト ×2

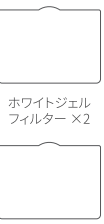

ホワイトジェル
フィルター ×2



レッドジェル
フィルター ×2

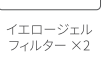

ブルージェル
フィルター ×2

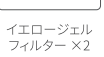

イエロージェル
フィルター ×2

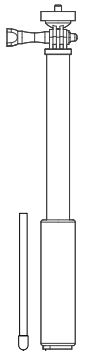

三脚 ×2

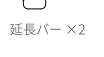

延長バー ×2



アダプター ×2

16

インストール手順

1. 三脚と延長ボールの取り付け方

① 三脚を反時計回りに回して延長バーの下部の1/4ネジ穴に入れます。

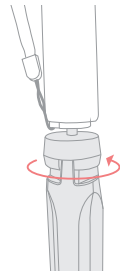

③ 三脚の三本足を開きます。

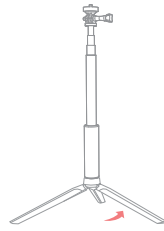

② 延長バーを引き抜き、高さを調整し、時計回りに回してロックします。

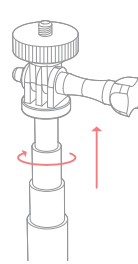

④ ノブを回して、延長バーの上部のコネクタの向き角度を調整します。

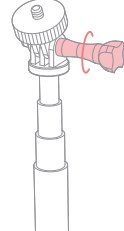

JP

17

インストール手順

2. LEDライトの使い方

① アダプターを反時計回りに回転させ、LEDライトパネルに取り付けます。延長バーを反時計回りに回転させ、アダプターに取り付けます。

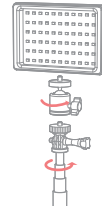

③ ライトヘッドの上から下にスライドさせて、LEDパネルにカラーゲルフィルターを挿入します。

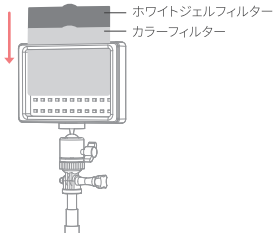

* 赤、青、黄色のフィルターは、白のフィルターと一緒に使用する必要があります。

② カラーフィルターの透明フィルムをはがします。



④ アダプターの回転ノブを調整して、LEDライトの角度を設定します。

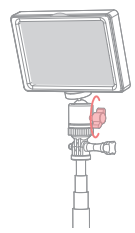

JP

18

商品説明

1. LEDの電源を入れます

USBプラグを5V / 2A電源に接続します。電源オン/オフインジケータライトは通常青色です。

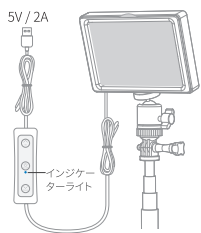

2. LEDライトのオン/オフを切り替えます

電源オン/オフボタンを押して、LEDライトをオンまたはオフにします。LEDライトが点灯すると、インジケータライトが消灯します。



3. 明るさUP

「UP」ボタンを1回押すと、LEDの明るさが10%増加します。「UP」ボタンを長押しすると、輝度出力が100%になります。

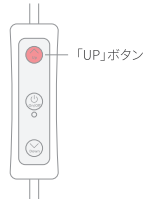

4. 明るさDOWN

「DOWN」ボタンを1回押すと、LEDの輝度が10%低下します。「DOWN」ボタンを長押しすると、輝度出力が10%になります。

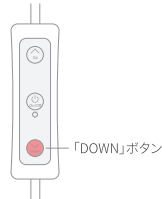

* このLEDライトは回路保護を備えて設計されているので、最大入力電圧を5Vに設定したライトを保護できます。

入力電圧が5Vを超えていると、ライトが点灯せず、コントローラーのインジケータが青色に点滅し始めます。ライトを正しく機能させるには、適切な電圧を選択してください。

19

安全上のご注意

- 40°C以上の環境に置かないでください。
- 使用中にライトを直視しないでください。光る部分を見続けると、目が疲れて、目の健康を損なう場合があります。
- 商品を可燃物や爆発物の近くに置かないでください。
- 雨の中や湿気の多い環境では使用しないでください。
- ご使用にならない時に本商品の電源を切ってください。
- 化学薬品や液体を使用してライトをクリーニングしないでください。
- 長期間ご使用にならない場合は、換気の良い乾燥した環境に置いてください。
- 本書に記載されている操作手順や警告に従わない場合、保証は無効になります。

JP

製品仕様

サイズ	142×97×20mm
ルーメン	1000LM
LED数量	66PCS
出力電力	10W
色温度	5600K
調光器	10%~100%
電源入力	USB 5V / 2A

20

Panoramica del prodotto

Il set di luci LED per desktop con attacco USB è un prodotto di illuminazione ausiliario utilizzato per la fotografia. Il pannello luminoso è composto da 66 bulbi LED dimmerabili a risparmio energetico che garantiscono una luce eccezionale. Dotato di filtri in gel colorati in bianco, rosso, giallo e blu e di un supporto regolabile in altezza riesce a soddisfare efficacemente le esigenze di varie tipologie di ripresa.



Shooting fotografico

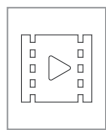

Registrazione video



L'illuminazione

IT

Contenuto del pacchetto

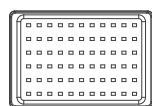

Luci LED x2



Filtri in gel colore bianco x2



Filtri in gel colore rosso x2



Filtri in gel colore blu x2

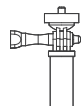

Barra estensibile x2



Treppiede x2



Adattatore x2



Barra estensibile x2

Filtri in gel colore giallo x2

21

Istruzioni per l'installazione

1. Configurare il treppiede ed estendere la barra.

① Ruotare il treppiede in senso antiorario nel foro della vite da 1/4 situato alla base dell'asta di estensibile.



③ Aprire le tre gambe del treppiede.

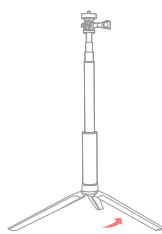

22

② Estrarre la barra estensibile regolandola all'altezza desiderata poi ruotarla in senso orario fino a bloccarla.

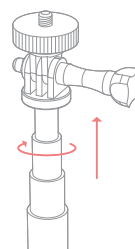

④ Ruotare la manopola per regolare l'angolo della staffa di collegamento sulla parte superiore dell'asta estensibile.

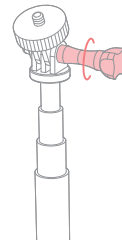

Istruzioni per l'installazione

2. Montaggio della luce LED

① Ruotare la staffa di supporto in senso antiorario ed installarla sulla luce del pannello a LED. Successivamente fissare la barra estensibile alla staffa di supporto ruotandola in senso antiorario.



③ Inserire il filtro in gel colorato nel pannello LED facendolo scorrere dall'alto verso il basso.

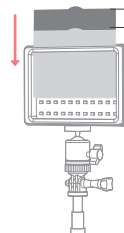

* I filtri in colore rosso, blu e giallo dovrebbero essere utilizzati insieme al filtro bianco.

② Rimuovere la pellicola trasparente dal filtro colorato.



④ Regolare l'angolo della luce LED regolando la manopola dell'adattatore.

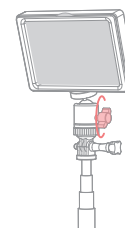

23

Istruzioni

1. Accensione delle lampade LED

Connettere la presa USB alla presa di alimentazione da 5V/2A. L'indicatore luminoso di alimentazione ON/OFF normalmente è di colore blu.

5V / 2A

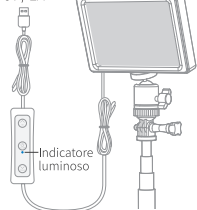

Indicatore luminoso

2. Accensione o spegnimento della luce LED

Premere il pulsante di alimentazione on/off per accendere o spegnere la luce LED. Una volta che la luce LED sarà accesa la spia si spegnerà*.



Alimentazione ON/OFF

3. Incrementare i livelli di luminosità

Premere una volta il tasto "UP" per aumentare la luminosità della luce LED del 10%. Mantenere premuto il tasto "UP" per incrementare la luminosità fino al 100%.



Pulsante "UP"

4. Ridurre il livello di luminosità

Premere una volta il pulsante "DOWN" per ridurre il livello della luminosità del 10%. Mantenere premuto il tasto "DOWN" per ridurre la luminosità fino al 10%.



Pulsante "DOWN"

* Questa luce LED è disegnata con un circuito di protezione per proteggere la luce. Il voltaggio d'ingresso massimo è impostato su 5V.

Quando non è possibile accendere la luce e l'indicatore luminoso del telecomando inizia a lampeggiare con una luce di colore blu, questo indica che il voltaggio d'ingresso eccede i 5V. Al fine del corretto funzionamento della luce assicurarsi di utilizzare un corretto voltaggio.

24

Note generali di sicurezza

- Si prega di non riporre il prodotto in un ambiente in cui la temperatura eccede i 40°C.
- Si prega di non fissare direttamente la luce quando in uso per ridurre il rischio di danni alla vista.
- Si prega di non riporre il prodotto in un ambiente con sostanze infiammabili o volatili.
- Si prega di non utilizzare il prodotto sotto la pioggia o in un ambiente umido.
- Si prega di sconnettere l'alimentazione quando non in uso.
- Non utilizzare alcohol o altri liquidi per pulire il prodotto.
- Se il prodotto non viene utilizzato per un lungo periodo si prega di riportarlo in un ambiente asciutto e ben ventilato. Si prega di mantenerlo lontano da fonti di calore e da campi magnetici.
- La mancata osservazione delle procedure operative e delle avvertenze elencate in questo manuale renderà nulla la garanzia.

IT

Specifiche del prodotto

Dimensione	142×97×20mm
Lumens	1000LM
LED	66PCS
Potenza in uscita	10W
Temperatura del colore	5600K
Dimmer	10%-100%
Potenza in ingresso	USB 5V / 2A

25

Descripción del producto

El juego de luces LED de escritorio USB es un producto de iluminación auxiliar utilizado para fotografía. El panel de luz cuenta con 66 bombillas LED de bajo consumo regulables que proporcionan una iluminación excepcional. Equipado con filtros de gel de color blanco, rojo, amarillo y azul, el soporte de luz ajustable en altura satisface eficazmente las necesidades de varios tipos de disparos.

ES



Toma de fotografías

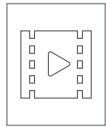

Grabación de video



Iluminación convencional

Contenido del producto

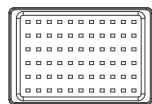

Luz LED × 2



Filtros de gel blanco × 2



Filtros de gel rojo × 2

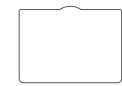

Filtros de gel amarillo × 2



Filtros de gel azul × 2

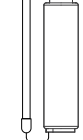
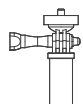

Barra extensible × 2

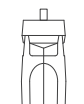

Trípode × 2



Adaptador × 2

26

Instrucciones de instalación

1. Coloque el trípode y la barra extensible.

① Gire el trípode en sentido antihorario en el orificio de tornillo de 1/4" en la base de la barra extensible.

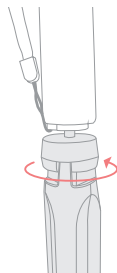

③ Posicione las tres patas del trípode.

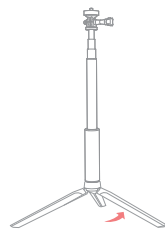

② Extienda la barra extensible, ajústela a una altura adecuada y gírela en sentido horario para asegurarla.

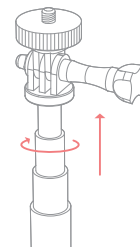

④ Gire la perilla para ajustar el ángulo del soporte de conexión en la parte superior de la barra de extensión.

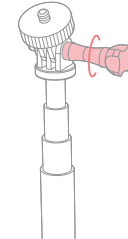

ES

27

Instrucciones de instalación

2. Monte la luz LED

① Monte el soporte en la luz del panel LED girándolo en sentido antihorario. Fije la barra de extensión al soporte girándola en sentido antihorario.

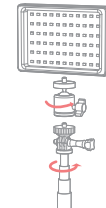

② Arranque el film transparente del filtro de color.

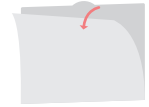

ES

28

③ Inserte el filtro de gel de color en el panel LED deslizando desde la parte superior a la inferior del cabezal de luz.

Filtros de gel blanco
Filtros de gel color

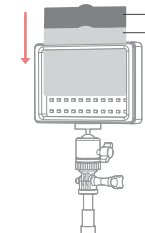

④ Establezca el ángulo de la luz LED ajustando la perilla de giro del adaptador.

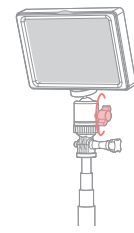

* Los filtros rojo, azul y amarillo deben usarse junto con el filtro blanco.

Instrucciones

1. Encienda el LED

Conecte el enchufe USB a la fuente de alimentación de 5V / 2A. La luz indicadora de encendido / apagado normalmente es azul.

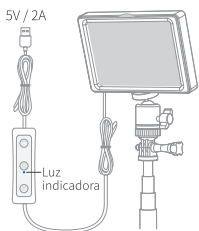

2. Encender / apagar la luz LED

Presione el botón de encendido / apagado para encender o apagar la luz LED. Una vez que se enciende la luz LED, la luz indicadora se apagará.



ES

3. Incrementa los niveles de brillo

Presione la tecla "ARRIBA" una vez para aumentar el brillo del LED en un 10%. Mantenga presionada la tecla hacia arriba para aumentar la salida de brillo al 100%.

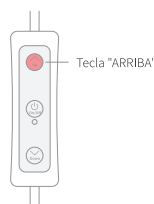

Tecla "ARRIBA"

4. Reducir el nivel de brillo

Presione la tecla "ABAJO" una vez para disminuir el brillo del LED en un 10%. Mantenga presionada la tecla "ABAJO" para disminuir la salida de brillo al 10%.

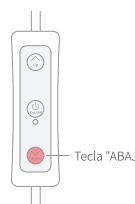

Tecla "ABAJO"

* Esta luz LED está diseñada con protección de circuito para proteger la luz. El voltaje de entrada máximo se establece en 5V.

Si la luz no se puede encender y el indicador en el controlador comienza a parpadear en azul, indica que el voltaje de entrada excede los 5V. Para que la luz funcione correctamente, asegúrese de utilizar el voltaje correcto.

29

Notas generales de seguridad

- No almacene el producto en un ambiente donde las temperaturas superen los 40 °C.
- No mire directamente a la luz durante el uso, puede causar daños en su vista.
- No almacene el producto en un entorno con sustancias inflamables o volátiles.
- No utilice el producto bajo la lluvia o en un ambiente húmedo.
- Desconecte la fuente de alimentación cuando no esté en uso.
- No use alcohol o líquido para limpiar la luz para evitar daños.
- Si no va a utilizar el producto durante un período prolongado, asegúrese de que el producto se mantenga en un ambiente seco y bien ventilado. Mantenga el producto alejado de campos magnéticos o zonas con una temperatura elevada.
- No seguir los procedimientos de operación y las advertencias que se enumeran en el manual anulará la garantía.

ES

Especificaciones del producto

Dimensiones	142×97×20mm
Lúmenes	1000LM
LED	66PCS
Potencia de salida	10W
Temperatura de color	5600K
Atenuador	10%~100%
Entrada de energía	USB 5V / 2A

30

Productoverzicht

Het USB desktop LED-lichtset is een verlichtingsproduct dat wordt gebruikt voor fotografie. Het lichtpaneel is voorzien van 66 dimbare energiebesparende LED-lampen, die zorgen voor een uitzonderlijke verlichting. De lamp is uitgerust met witte, rode, gele en blauwe kleurengel filters. De in hoogte verstelbare lampstatief voldoet effectief aan de behoeften van verschillende soorten opnamen.



Foto-opnamen

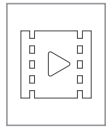

Video-opnamen



Conventionele verlichting

NL

Paklijst

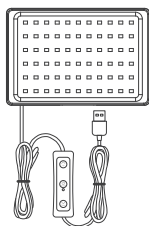

LED-licht ×2



Witte Gelfilters ×2



Rode Gelfilters ×2



Gele Gelfilters ×2



Blauwe Gelfilters ×2

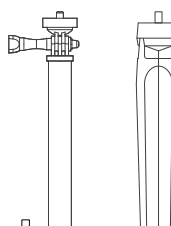

Statief ×2



Adapter ×2

31

Installatie instructies

1. Statief en stang opzetten

① Schroef het statief (tegen de klok in) in het 1/4" schroefgat onderaan de uitschuifbare stang.

② Trek de uitschuifbare stang uit, stel deze in op de juiste hoogte en draai hem kloksgewijs aan.

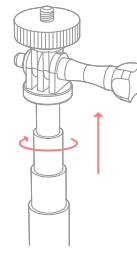
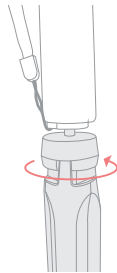

③ Plaats de drie statiefpoten.

④ Draai aan de knop om de hoek van de verbingsbeugel aan de bovenkant van het verlengstuk aan te passen.

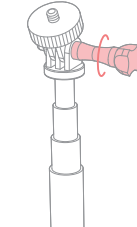
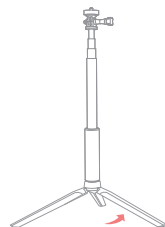

32

Montage van de LED-lamp

2. Montage van het LED paneel

① Monteer de steunbeugel op de LED-paneelverlichting door deze tegen de klok in te draaien. Bevestig het verlengstuk aan de steunbeugel door deze tegen de klok te draaien.

② Verwijder de transparante film van de kleurenfilter.

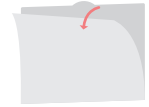
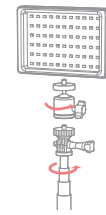

③ Plaats het kleurengel filter in het LED-paneel door van de bovenkant naar de onderkant van de lichtkop te schuiven.

④ Stel de hoek van het LED-licht in door de draaiknop van de adapter aan te passen.

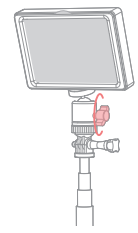
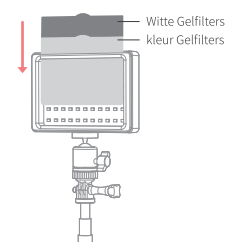

* Rode, blauwe en gele filters moeten samen met het witte filter worden gebruikt.

33

Instructies

1. Schakel de LED lamp in

Sluit de USB-stekker aan op de 5V/2A -voeding. Het AAN/UIT-indicatielampje is normaal gesproken blauw.

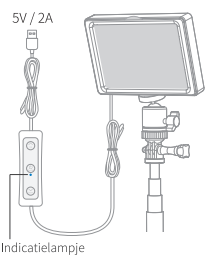

Indicatielampje

2. Zet de LED-lamp aan / uit

Druk op de aan / uit-knop om de LED lamp aan of uit te zetten. Zodra de LED lamp is ingeschakeld, gaat het indicatielampje uit.



Inschakelen / uitschakelen

3. Helderheid verhogen

Druk eenmaal op de "OMHOOG" -toets om de helderheid van de LED met 10% te verhogen. Druk lang op de "OMHOOG"-toets om de helderheid te verhogen tot 100%.



"OMHOOG" toets

4. Helderheid verlagen

Druk eenmaal op de "OMLAAG" toets om de helderheid van de led met 10% te verlagen. Druk lang op de "OMLAAG" toets om de helderheid te verlagen tot 10%.



"OMLAAG" toets

* Deze led-lamp heeft een circuitbeveiliging om de lamp te beschermen. De maximale ingangsspanning is ingesteld op 5V.

Als de lamp niet kan worden ingeschakeld en de indicator op de controller blauw begint te knipperen, geeft dit aan dat de ingangsspanning 5V overschrijdt. Zorg ervoor dat het juiste voltage wordt gebruikt voor een correcte werking van de lamp.

34

Algemene veiligheidsaanwijzingen

- Bewaar het product niet in een omgeving met temperaturen hoger dan 40 °C.
- Kijk tijdens het gebruik niet direct in het licht om het risico op slechtziendheid te verminderen.
- Bewaar het product niet in een omgeving met ontvlambare of vluchtige stoffen
- Gebruik het product niet in de regen of in een vochtige omgeving.
- Koppel de voedingsbron los als deze niet wordt gebruikt.
- Reinig de lamp niet met alcohol of vloeistof om schade te voorkomen.
- Als u van plan bent het product langere tijd niet te gebruiken, zorg er dan voor dat het product in een droge en goed geventileerde omgeving wordt bewaard. Hou de lamp uit de buurt van hete of magnetische velden.
- Als de bedieningsprocedures en waarschuwingen in de handleiding niet worden gevolgd, vervalt de garantie.

NL

product specificaties

Afmetingen	142×97×20mm
Lumen	1000LM
LED aantal	66 stuks
Uitgangsvermogen	10W
Kleurtemperatuur	5600K
Dimmer	10%~100%
Ingangsvermogen	USB 5V / 2A

35

产品概述

USB 桌面LED灯套装是一款拍摄辅助照明产品。66个可调亮度的节能LED灯泡组成的灯板,提供出色的照明,配备白、红、黄、蓝四种颜色的滤色片、可调节高度的灯架能满足各种照明拍摄需求。



照片拍摄

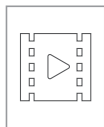

视频录像

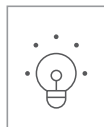

常规照明

包装清单

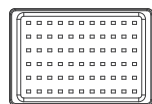

LED灯 × 2



白色滤色片 × 2



红色滤色片 × 2

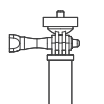

三角架 × 2



延长杆 × 2



转接头 × 2

黄色滤色片 × 2

蓝色滤色片 × 2

CN

36

安装说明

1. 安装三角架、延长杆

① 将三角架逆时针旋转装入延长杆底部1/4螺丝孔。

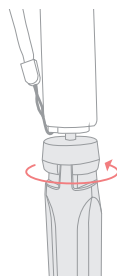

③ 打开三角架的三个支脚。

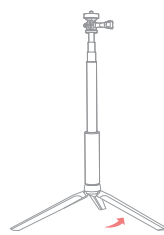

② 拉出延长杆,调整合适高度后顺时针旋转锁紧。

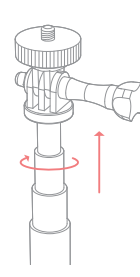

④ 旋转旋钮可调节延长杆顶部连接头的朝向角度。

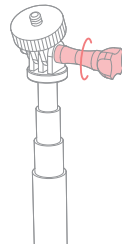

CN

37

安装说明

2. 安装LED灯

① 将转接头按逆时针方向旋转安装在LED灯板上。
将延长杆按逆时针方向旋转安装在转接头上。

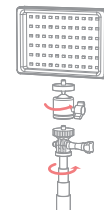

③ 将滤色片从上往下插入LED灯板中。

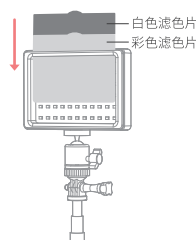

* 使用彩色滤色片时需配合白色滤色片一起使用。

② 撕除彩色滤色片上的透明薄膜。



④ 通过调节转接头的旋钮来调整LED灯的角度。

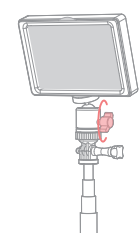

CN

38

使用说明

1. 给LED灯通电

将USB插头接入5V / 2A电源,开关指示灯蓝色常亮。

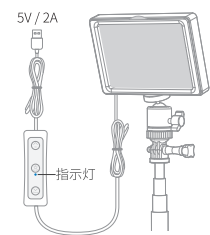

2. 开启、关闭LED灯

点按开关键可开启或关闭LED灯,开启后,指示灯熄灭。



3. 提高亮度

每点按一次向上键,LED灯亮度提高10%,长按向上键,可将亮度提高至100%。



4. 降低亮度

每点按一次向下键,LED灯亮度降低10%,长按向下键,可将亮度降低至10%。



* 这款LED灯设计有电路保护,以保护最大输入电压为5V的灯。

如果灯不亮并且控制器上的指示灯开始闪烁蓝色,则表示输入电压超过5V。为了使灯正常工作,请选择合适的电压。

39

注意事项

- 请勿将产品放置于温度高于40°C环境下。
- 使用时,请勿直视灯,直视光线会导致视力受损。
- 请勿将产品放置在易燃易爆附近。
- 请勿在雨中或潮湿的环境中使用产品。
- 不使用时,请将电源关闭。
- 请勿在LED灯体上使用酒精或液体擦拭产品。
- 如果长时间不使用,应将产品放在通风、干燥、远离热源,磁场的地方。
- 不遵守手册中的所有步骤和警告将使保修无效。

CN

产品参数

产品尺寸	142×97×20mm
光通量	1000LM
LED数量	66PCS
输出功率	10W
色温	5600K
调光器	10%~100%
电源输入	USB 5V / 2A

40

备注:

1. 名称:USB桌面LED双灯套装说明书
2. 尺寸:80*120mm
3. 材质:105g双面铜版纸
4. 印刷:四色双面印刷
5. 装订方式:胶装