

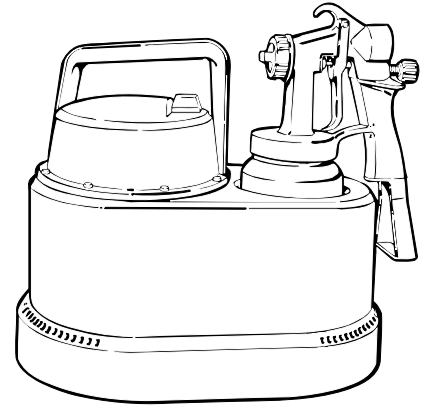

FINE COAT™

LOW OVERSPRAY FINISHING SYSTEM



EASY DOES IT FROM SET UP TO CLEAN UP



Read all warning before operation

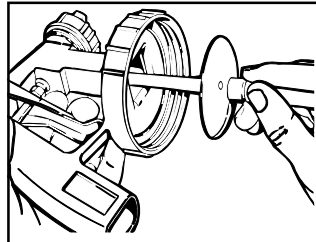

Attach suction tube and valve

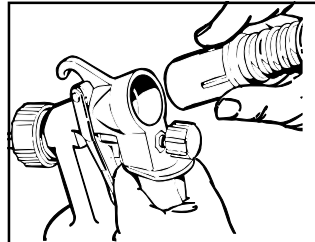

Attach air hose

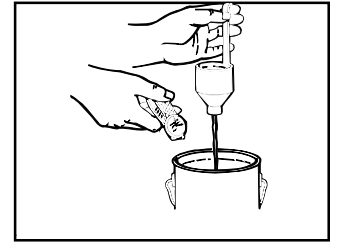

Paint preparation



Fill container

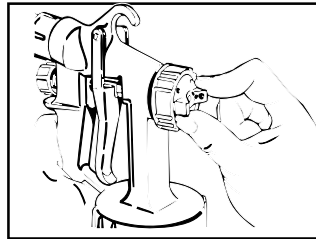

Adjust spray pattern

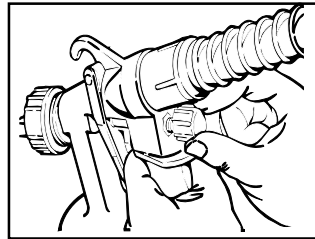

Adjust material flow

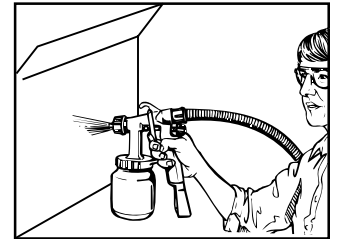

Practice before spraying

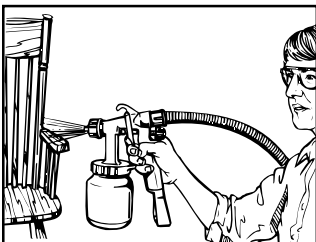

Proper spraying technique

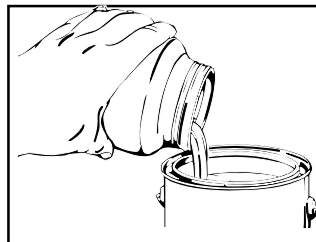

Pour remaining paint back into can

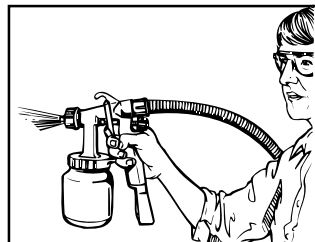

Spray appropriate cleaner through gun

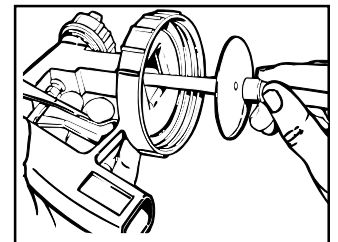

Reassemble

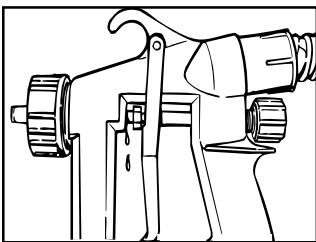

Troubleshooting

WARNING

General - May cause property damage or severe injury.

- Read all instructions and safety precaution before operating.
- Comply with all appropriate local, state and national code governing ventilation, fire prevention, and operation.
- The United States Government Safety Standards have been adopted under Occupational Safety and Health Act. The standard, particularly the General Standard, Part 1910 and construction Standard, Part 1926, should be consulted.
- This equipment is designed to be used with authorized parts only. When using this equipment with parts that do not comply with the minimum specification and safety device of the equipment manufacturer, the user assumes all risks and liabilities.
- Never aim the spray gun at any part of the body.

Hazardous vapor - Paint, solvent, insecticide, and other material may be harmful if inhaled causing nausea, fainting, or poisoning.

- Use respirator or mask whenever there is a chance that vapor may be inhaled. Read all instructions with the mask to insure that it will provide the necessary protection against the inhalation of harmful vapor.

Explosion or fire-Solvent and paint fumes can explode or ignite causing property damage and or severe injury.

- Exhaust and fresh air introduction must be provided to keep the air within the spray area free from accumulation of flammable vapor.
- Keep turbine maximum distance possible from the spray area.
- Avoid all ignition sources such as static electricity, spark, open flame such as a pilot light, hot object such as a cigarette, and spark from connecting and disconnecting power cord and working light switches.
- Fire extinguishing equipment must be present and in working order.
- Power cord must be connected to a grounded circuit.
- Follow the material and solvent manufacturer's safety precaution and warning.
- Cleaning solvent must have a flashpoint above 100°F (37.8°C). Flashpoint is the temperature at which a fluid begins to give off sufficient amount of flammable vapor that could ignite when exposed to a flame or spark. Contact your coating supplier for more information.

THIS UNIT IS PROVIDED WITH A THERMAL PROTECTOR WHICH RESETS AUTOMATICALLY. IF AN OVERLOAD OCCURS THE THERMAL PROTECTOR AUTOMATICALLY DISCONNECTS THE MOTOR FROM THE POWER SUPPLY.

THE MOTOR WILL RESTART WITHOUT WARNING WHEN THE PROTECTOR AUTOMATICALLY RESETS.

SHOULD THIS CONDITION OCCUR TURN ON-OFF SWITCH TO THE "O" (OFF) POSITION. TAKE TO A WAGNER AUTHORIZED SERVICE CENTER.

GROUNDING INSTRUCTIONS

Extension Cord

Use only a 3 wire extension cord that has a 3 blade grounding plug, and a 3 slot receptacle that will accept the plug on the product. Make sure your extension cord is in good condition. When using an extension cord, be sure to use one heavy enough to carry the current your product will draw. An undersized cord will cause a drop in line voltage resulting in loss of power and overheating. SEE TABLE BELOW FOR PROPER GAGE OF EXTENSION CORD.

MINIMUM GAGE FOR EXTENSION CORD LENGTH

25 FT	18 AWG
50 FT	16 AWG
100 FT	12 AWG
150 FT	10 AWG
200 FT	10 AWG
250 FT	8 AWG
300+ FT	6 AWG

This product must be grounded. In the event of an electrical short circuit, grounding reduces the risk of electric shock by providing an escape wire for the electric current. This product is equipped with a cord having a grounding wire with an appropriate grounding plug. The plug must be plugged into an outlet that is properly installed and grounded in accordance with all local code and ordinance.

DANGER—Improper installation of the grounding plug can result in a risk of electric shock.

If repair or replacement of the cord or plug is necessary, do not connect the green grounding wire to either flat blade terminal. The wire with insulation having an outer surface that is green with or without yellow stripes is the grounding wire and must be connected to grounding pin.

Check with a qualified electrician or serviceman if the grounding instructions are not completely understood, or if in doubt as to whether the product is properly grounded. Do not modify the plug provided; if it will not fit the outlet, have the proper outlet installed by a qualified electrician.

This product is for use on a nominal 120 volt circuit, and has a grounding plug that looks like the plug illustrated in sketch A. A temporary adapter which looks like the adapter illustrated in sketch B and C, may be used to connect this plug to a 2 pole receptacle as shown in sketch B if a properly grounded outlet is not available. The temporary adapter should be used only until a properly grounded outlet (sketch A) can be installed by a qualified electrician. The green colored rigid ear lug, or the like extending from the adapter must be connected to a permanent ground such as a properly grounded outlet box cover. Whenever the adapter is used, it must be held in place by a metal screw.

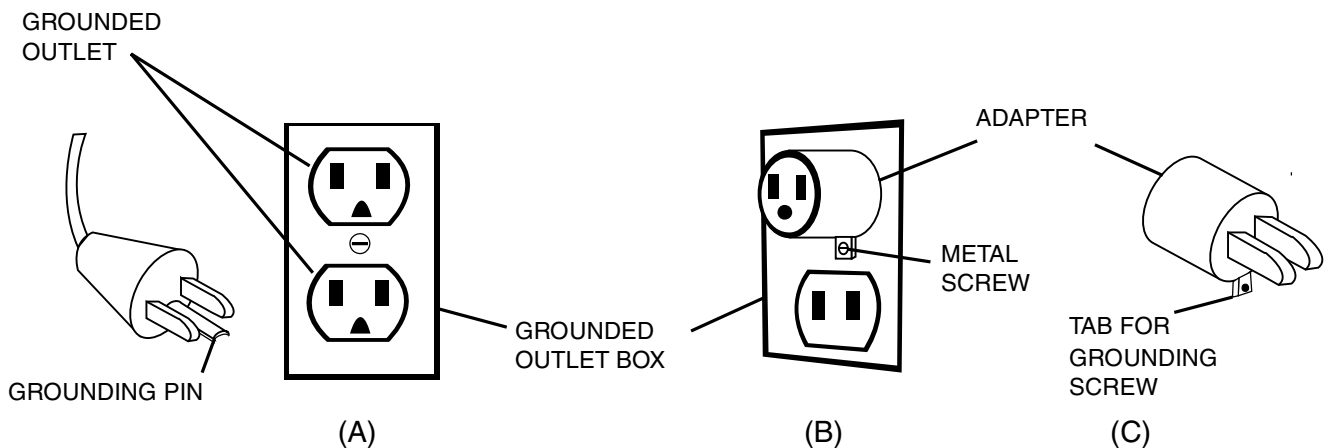

SET-UP

ATTACH SUCTION TUBE

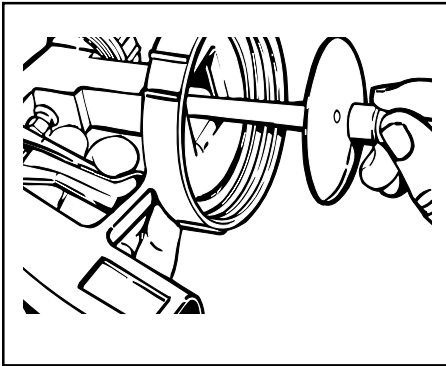

Unscrew the paint container from the gun. Push the long, tapered end of the plastic suction tube with a firm, twisting motion into the gun body.

If you are going to be spraying in a downward direction the angled end of the suction tube should be pointing toward the front of the gun. If you are going to be spraying in an upward direction the angled end of the suction tube should be pointing toward the rear of the gun. By pointing the suction tube in the proper direction you will not have to refill the container as often.

NOTE

There is a small vent hole in the cup seal. This hole must be open to assure proper paint flow. Be sure to clean after each use.

ATTACH AIR HOSE

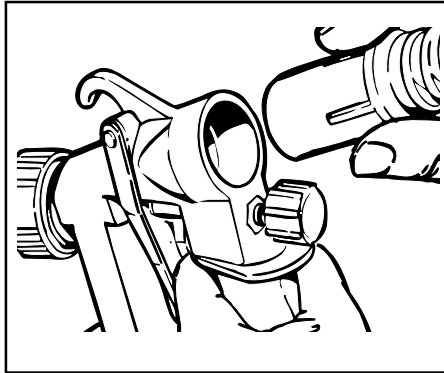

Take the air hose and push one end firmly into the large opening at the rear of the spray gun. Insert the other end of the hose into the turbine cover, aligning the tab on the hose with the slot in the fitting. Push the hose in and turn clockwise 90° to lock the hose in place. To remove the hose from the fitting, turn 90° counterclockwise to align the tab on the hose with the slot in the fitting and pull out.

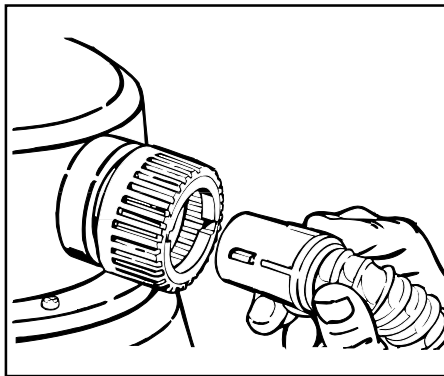

NOTE

Allow the hose to cool down before attempting to remove from the turbine and always grasp the hose by the fitting to remove rather than by the hose.

PAINT PREPARATION

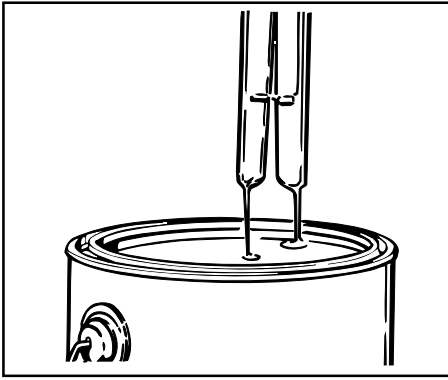

Before spraying, the material being used may need to be thinned with the proper solvent as specified by the material manufacturer. Two basic methods of thinning material are explained below.

THE VISUAL REDUCTION METHOD

This is the simplest method available and can be used in most cases. To start, simply mix in the appropriate thinner until material looks to be the right consistency. To test for proper viscosity dip a paint stir stick into the material then remove it. Watch carefully as the material runs off and begins to form drops. The drops should be about one second apart as a general rule of thumb.

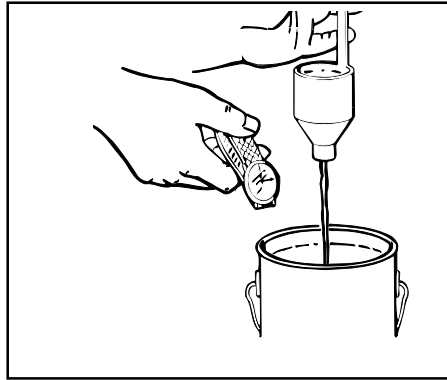

THE VISCOSITY CUP METHOD

The chart below gives the approximate time for this method. All measurements are taken with the Wagner viscosity cup included with your system. To use this method simply dip the cup in the material and then remove, noting the time it takes for the cup to empty.

NOTE

Material to be sprayed should always be strained to remove any impurities in the paint which may enter and clog the system. Impurities in the paint will give poor performance and a poor finish as well as premature wear to moving parts.

FILL CONTAINER

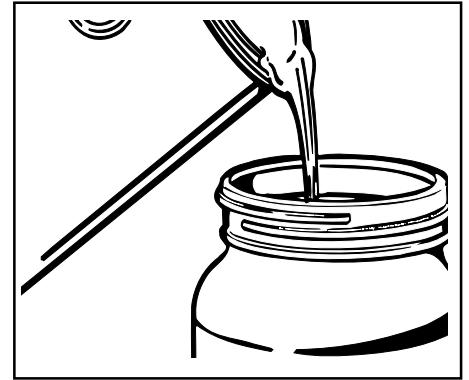

After the paint has been properly thinned and strained fill the paint container to the bottom of the neck. Before screwing the paint container back onto the gun body inspect the cup seal to be sure there are no cuts or rips in the seal which could lead to poor performance of the spray gun. Screw the paint container onto the gun body tightly.

Now simply plug the turbine into a 110 volt power source and turn it on by pushing the rocker switch to the "I" position and you are ready to begin painting. THE "I" POSITION ON THE ROCKER SWITCH TURNS THE UNIT ON, AND THE "O" POSITION TURNS THE UNIT OFF.

NOTE

The spray gun will not spray in the upside down position because the paint suction tube must be immersed in the paint.

VISCOSITY CUP THINNING CHART

MATERIAL TO BE SPRAYED

Oil Enamel
Oil Based Primer
Oil Stain
Clear Sealer
Polyurethane
Varnish
Lacquer sanding sealer
Lacquer
Automotive Finish

SECONDS TO EMPTY VISCOSITY CUP

20 -30
25 -35
No thinning required
No thinning required
20 -30
Refer to Manufacturer recommendation
20 -25
20 -25
Refer to Manufacturer recommendation

The FINECOAT™ SYSTEM can spray some thinned latex paint, but for large flat areas where heavy bodied latex is to be applied we recommend a Wagner 200 or 300 Series airless sprayer.

OPERATION

ADJUST SPRAY PATTERN

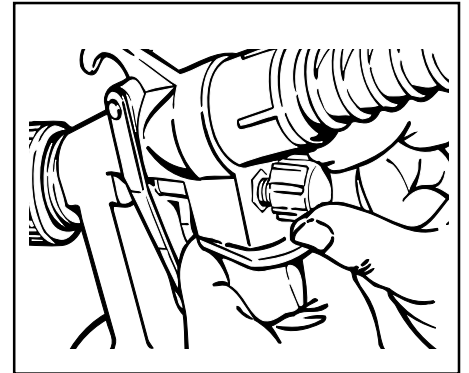
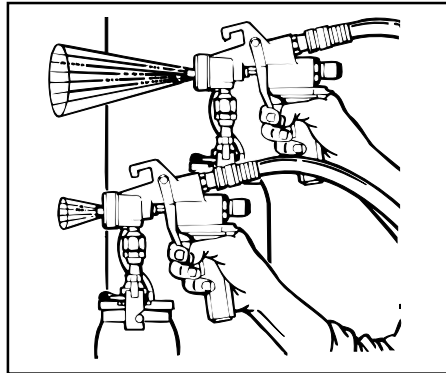
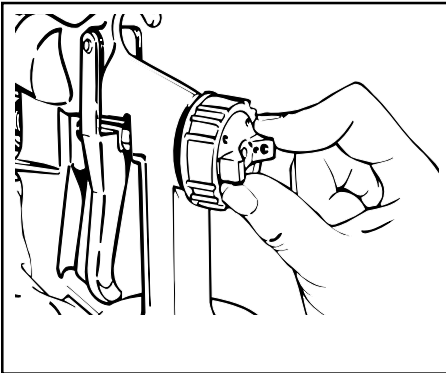

PATTERN SHAPE SELECTION:

The spray pattern shape is adjusted by turning the ear of the air cap to either the vertical, horizontal, or diagonal position. The position of the air cap and the corresponding spray pattern shape are illustrated below. Test each pattern and use whichever pattern is suitable for your application.

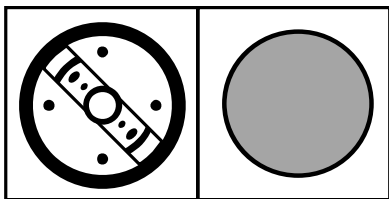

ROUND PATTERN

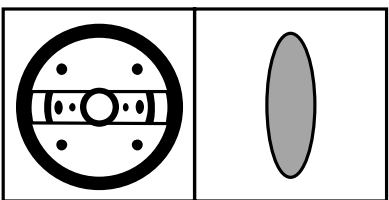

VERTICAL PATTERN

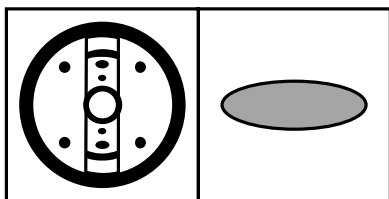

HORIZONTAL PATTERN

PATTERN SIZE ADJUSTMENTS:

If you want to change the size of your spray pattern simply move closer to or farther from your workpiece. In doing so you may have to reduce your material flow if you move closer to your workpiece and increase your material flow if you move farther from your workpiece. (See material flow adjustment). The farther back from the workpiece the greater the chance you will have to move over spray.

NOTE

As long as the turbine is turned on there will be a constant airflow out the tip of the gun, this is normal. The cup remains pressurized when the turbine is turned off. Do not pull the trigger on the gun unless the turbine is turned on or the paint will squirt out a stream. To remove pressure in the cup simply loosen by uncranking 1/2 turn.

Do not pull the turbine by the hose, Use the handle on the top of the turbine.

⚠ WARNING

NEVER TRIGGER GUN WHILE ADJUSTING THE EARS ON THE AIR CAP.

Never point the spray gun at any part of the body.

MATERIAL FLOW ADJUSTMENTS:

To adjust the amount of material being sprayed, turn the knob located on the back of the gun and under the air hose clockwise to decrease the amount of paint or counterclockwise to increase the amount of paint being sprayed. Each individual job and material may require a light adjustment to the setting. **For your individual need spray first on a test surface.**

USING THE INFLATOR NOZZLE

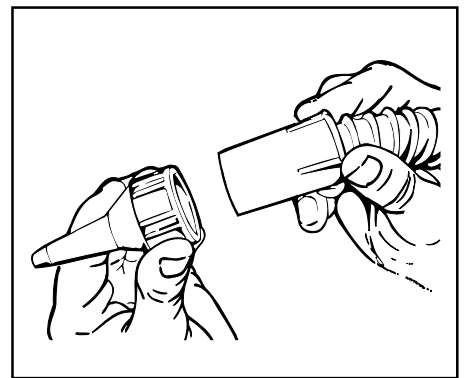

An added feature of this system, a nozzle is supplied which can be used to inflate air mattresses and other type of inflatable. To use the inflator nozzle, attach one end of the air hose to the nozzle and the other end to the turbine. Next, insert the small end of the inflator nozzle into the item to be inflated and turn on the turbine. Be careful not to over-inflate (will not inflate tire).

PROPER SPRAYING TECHNIQUE

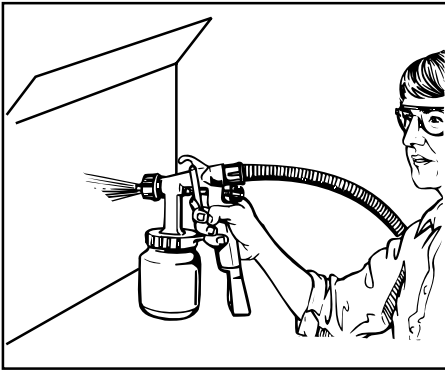

WARNING

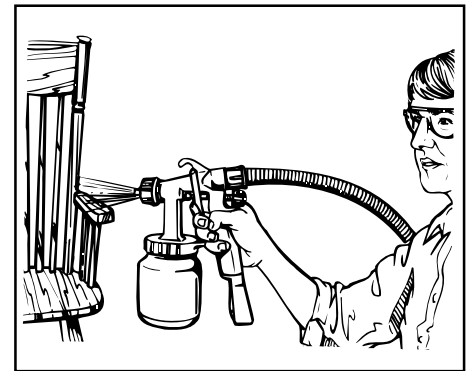

TEST SPRAY PATTERN

If spraying with an HVLP spray gun is new or unfamiliar to you it is advisable to practice on a piece of scrap wood or cardboard before beginning on your intended workpiece.

SURFACE PREP.

All objects to be sprayed should be thoroughly cleaned before spraying material on them. Areas not to be sprayed may, in certain cases, need to be masked.

SPRAY AREA PREP.

When spraying indoors, the spray area must be clean and free of dust in order to avoid blowing dust onto your freshly painted surface.

Explosion or fire-Solvent and paint fumes can explode or ignite causing property damage and or severe injury.

- Exhaust and fresh air introduction must be provided to keep the air within the spray area free from accumulation of flammable vapor.
- Keep turbine maximum distance possible from the spray area.

HOW TO SPRAY PROPERLY

Position the spray gun perpendicular to and 1 or more inches from the spray surface, depending on the spray pattern size desired. Spray parallel to the surface with smooth passes at a consistent speed as illustrated in Figure 2. Doing this will help avoid irregularities in the finish, i.e. runs and sags. Always apply a thin coat of material on the first pass and allow to dry before applying a second, lightly heavier coat.

When spraying, always trigger the spray gun after the spray pass has begun and release the trigger before topping the pass. The best results occur when making 20 inch passes. Always keep the gun pointed squarely at the spray surface and overlap passes lightly to obtain the most consistent and professional finish possible.

NOTE

If any problem occurs, refer to the troubleshooting chart on Page 9 for problem identification and suggested solution(s).

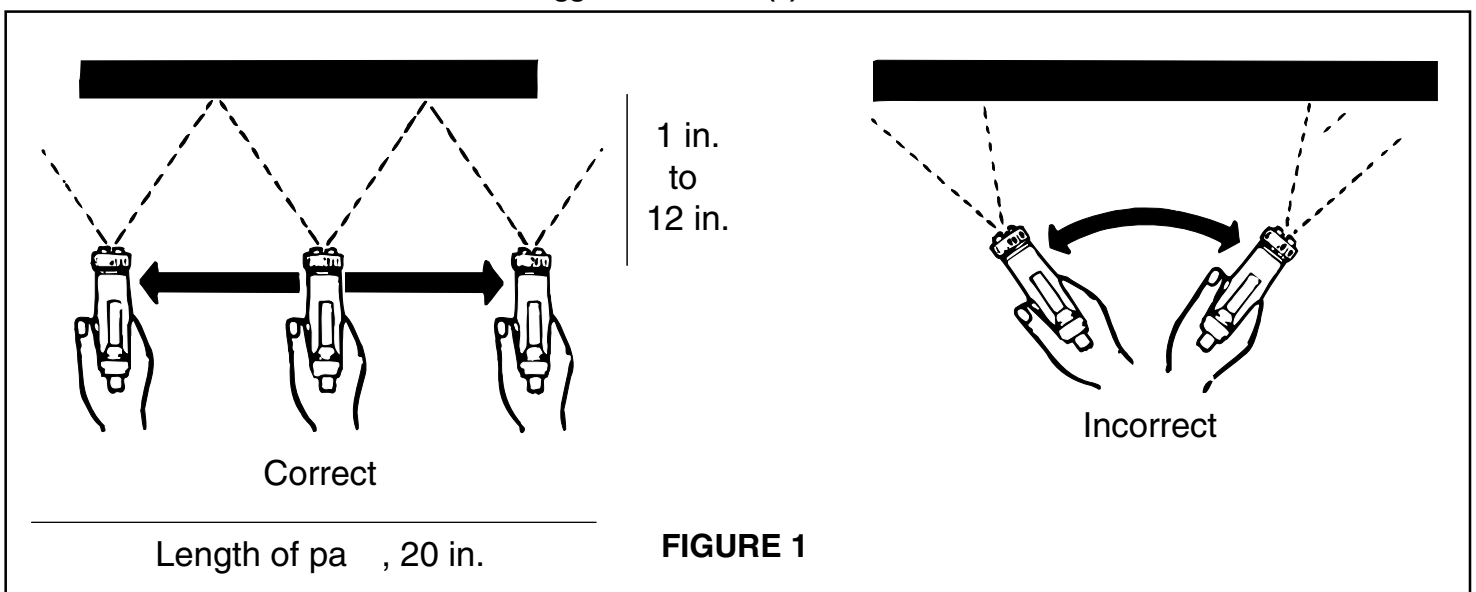

CLEAN-UP

EMPTY PAINT CONTAINER

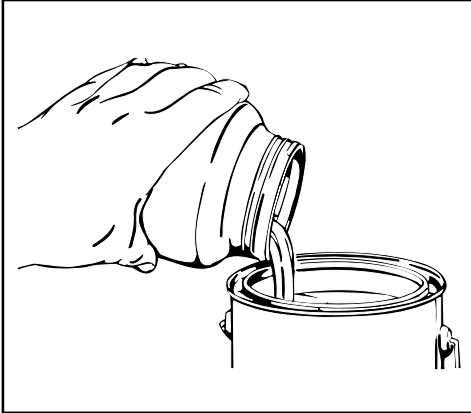

Pour the remaining paint from the container back into the paint can after use.

SPRAY APPROPRIATE CLEANER THROUGH GUN

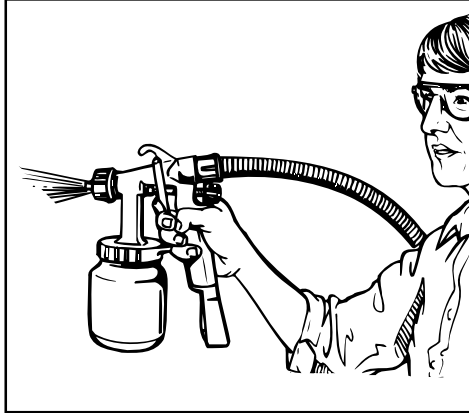

Pour a small amount of the appropriate solvent in the cup, attach cup to gun, shake and spray solvent through the gun in a safe area.

Repeat above step once or twice until the cup is clean, then wipe exterior of cup and gun clean.

Be sure to remove and clean the suction tube and sealing surface inside the gun after each use.

DISASSEMBLE AND CLEAN SMALL PARTS

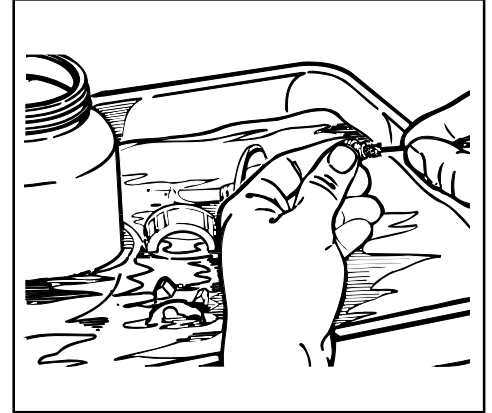

Remove projector set, (nozzle, needle & air cap) and clean with a soft brush and solvent or by soaking for a short period of time. Never use any metal tool to pick at the air cap or fluid nozzle hole.

Disassemble the needle from the gun by unscrewing material adjustment knob, removing the needle spring and pulling the needle straight out the rear of the gun.

Disassemble the fluid nozzle from the gun by unscrewing the retaining ring, removing the air cap and air flow diverter, and unscrewing the fluid nozzle with a 10 mm open end or adjustable wrench.

REASSEMBLE

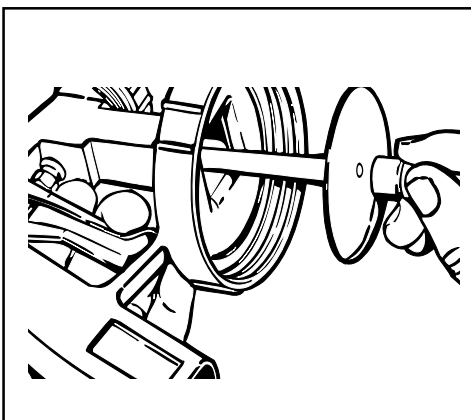

Reassemble any part that were disassembled for cleaning. When replacing the suction tube and paint container for storage do not assemble too tightly.

During clean-up with certain solvent the valve cup on the suction tube may become wrinkled. Don't become alarmed, it will regain its shape in a short time.

TROUBLE SHOOTING

PROBLEM	CAUSE	REMEDY
Little or no paint flow	Dried paint blocking fluid nozzle No air pressure in paint cup No fluid pressure Blockage in suction tube Gun upside-down Dirty air filter Plugged vent hole in cup seal	Disassemble and clean Inspect suction tube or cup, clean or replace. Check material supply Clean by flushing with solvent Turn right side up Clean air filter unplug vent hole
Paint leaking	Damaged needle or nozzle Loose nozzle Loose packing nut Needle not closing properly Loose cup	Replace Tighten Tighten Loosen packing nut, Replace needle spring, Remove dried paint from needle Tighten
Poor spray pattern	Air hole in air cap ear are clogged Nozzle is clogged Damaged nozzle, needle, or air cap	Remove and clean air hole Clean with appropriate solvent Remove and replace
Pulsating spray	Low paint supply in cup Loose or damaged suction tube	Add paint Tighten or replace
Pattern is heavy in middle	Too much fluid flow	Reduce material flow
Gun pitting paint	Low paint supply in cup Material too thick Loose or damaged suction tube	Add paint Thin material Tighten or replace
Too much overspray	Material too thin Spray gun too far from surface Flow rate too high	Add unthinned paint Move closer Reduce flow rate
Pattern runs or sags	Applying too much paint	Adjust material flow or increase movement of spray gun
Pattern is very light and blotchy	Moving the spray gun too fast	Adjust material flow or decrease movement of spray gun
Unit does not run	Not plugged in Switch broken Motor burned out Thermal protector disconnected	Plug in Send to Wagner Authorized service center
Low air flow	Air inlet hole blocked Air hose plugged Air filter blocked	Remove blockage Unplug hose Clean or replace air filter

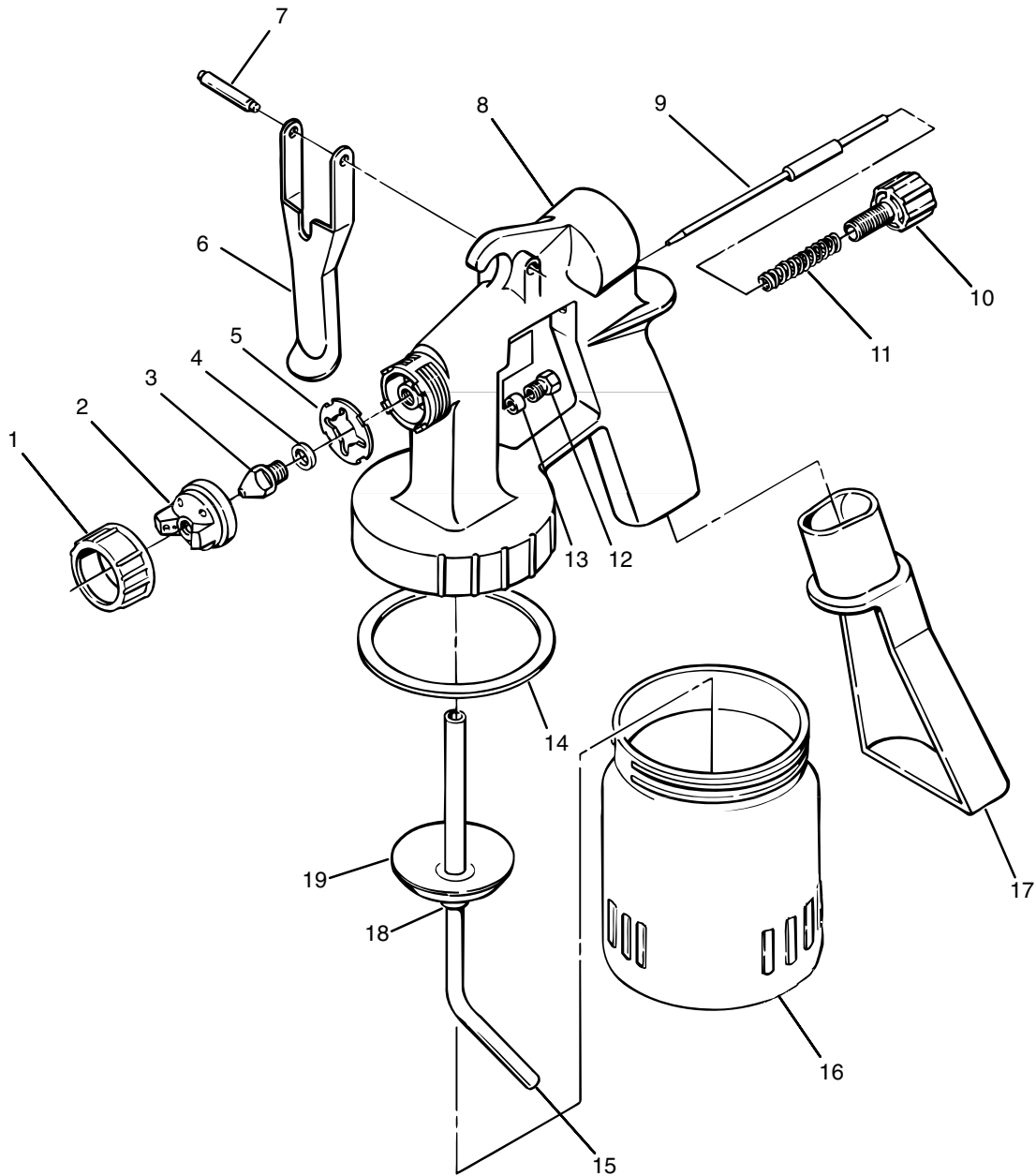

0276200 SPRAY GUN ASSEMBLY - FIGURE 2

<u>ITEM</u>	<u>PART NO.</u>	<u>DESCRIPTION</u>	<u>QTY</u>	<u>ITEM</u>	<u>PART NO.</u>	<u>DESCRIPTION</u>	<u>QTY</u>
1	0276485	Ring,Retaining	1	11	0276305	Spring,Needle	1
2	0276340	Cap, Air	1	12	0276316	Nut, Packing	1
3		Nozzle Fluid	1	13	0276308	Packing, Needle	1
4	0276311	Wa her, Nozzle	1	14	0276315	Ga ket, Cup	1
5	0276306	Diverter, Air Flow	1	15	0276309	Suction Tube	1
6	0276312	Trigger	1	16	0276314	Cup, Material	1
7	0276319	Pin, Trigger	1	17	0276399	Gun, Stand	1
8	0276486	Gun Body	1	18	0276341	Clamp, ring	1
9		Needle A ssembly	1	19	0276322	Valve, cup	1
10	0276220	Knob, Material adju tment	1	20	0276231	Needle / Nozzle Replacement Kit (include #3 and #9)	

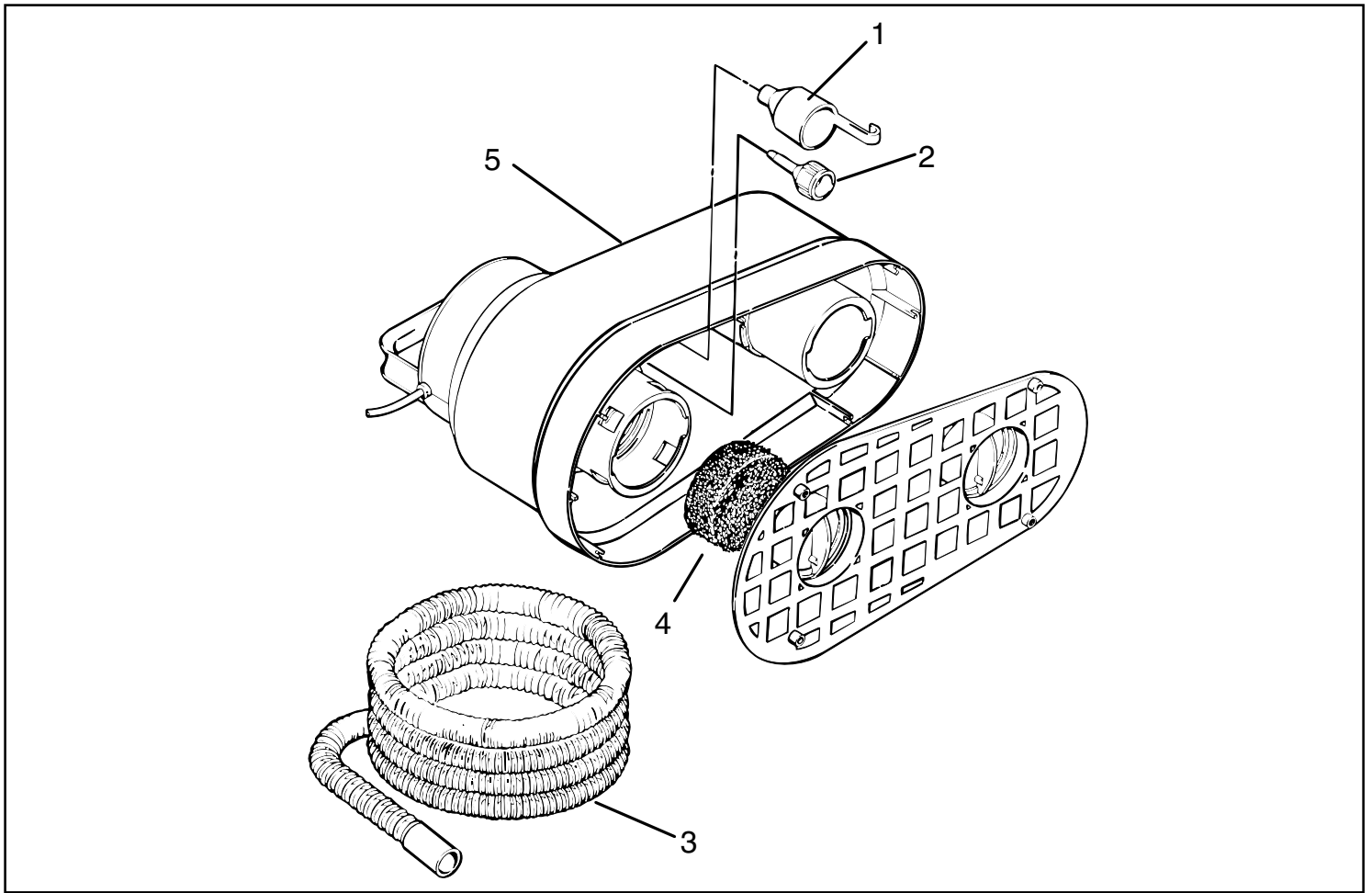

TURBINE AND ACCESSORIES - FIGURE 3

<u>ITEM</u>	<u>PART NO.</u>	<u>DESCRIPTION</u>	<u>QTY</u>	<u>ITEM</u>	<u>PART NO.</u>	<u>DESCRIPTION</u>	<u>QTY</u>
1	0153165	Cup, Vi co ity	1	4	0276344	Filter, Air	1
2	0276342	Nozzle, Inflator	1	5		Turbine, A ssembly	1
3	0276321	Hose, Air					

Replacement part and accessories can be purchased from a Wagner Authorized Service Center. If you still need assistance, call Wagner Technical Service 1-800-328-8251.

Tightening Packing Nut

If material leak from in front of the trigger the packing need to be tightened. When tightening the packing nut only tighten the nut lightly and then pull the trigger to assure free movement of the trigger. Overtightening the packing nut will cause the fluid needle to tick open.

Do not overtighten the packing nut.

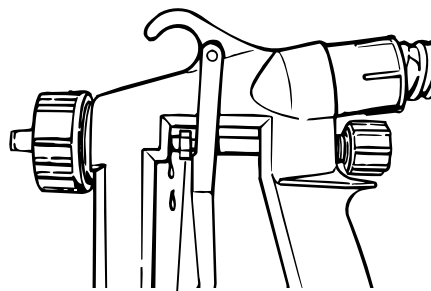

Packing Nut

TECHNICAL ASSISTANCE

If you have any question or need further assistance, call Wagner Technical Service 1-800-328-8251 between the hour of 8:00 A.M. and 4:30 P.M., C.S.T., Mon. through Fri. and between the hour of 9:00 A.M. and 4:00 P.M., C.S.T., Sat. and Sun. Closed major holiday.

LIMITED WARRANTY HVLP PAINT SPRAY EQUIPMENT

This product, manufactured by Wagner Spray Tech Corporation (Wagner), is warranted against defect in material and workmanship for ninety days following date of purchase if operated in accordance with Wagner's printed recommendation and instructions. This warranty does not cover damage resulting from improper use, accident, user's negligence or normal wear. This warranty does not cover any defect or damage caused by service or repair performed by anyone other than a Wagner Authorized Service Center.

ANY IMPLIED WARRANTY OF MERCHANTABILITY OR FITNESS FOR A PARTICULAR PURPOSE IS LIMITED TO NINETY DAYS FOLLOWING DATE OF PURCHASE. WAGNER SHALL NOT IN ANY EVENT BE LIABLE FOR ANY INCIDENTAL OR CONSEQUENTIAL DAMAGES OF ANY KIND, WHETHER FOR BREACH OF THIS WARRANTY OR ANY OTHER REASON. THIS WARRANTY DOES NOT APPLY TO ACCESSORIES.

THIS PRODUCT IS DESIGNED FOR HOME USAGE ONLY. IF USED FOR COMMERCIAL OR RENTAL PURPOSES, THIS WARRANTY APPLIES ONLY FOR 30 DAYS FROM DATE OF PURCHASE.

If any product is defective in material and/or workmanship during the applicable warranty period, return it with proof of purchase, transportation prepaid to any Wagner Authorized Service Center. (Service Center listing is enclosed with this product.) Wagner's Authorized Service Center will either repair or replace the product (at Wagner's option) and return it to you, postage prepaid.

SOME STATES DO NOT ALLOW LIMITATIONS ON HOW LONG AN IMPLIED WARRANTY LASTS OR THE EXCLUSION OF INCIDENTAL OR CONSEQUENTIAL DAMAGES, SO THE ABOVE LIMITATION AND EXCLUSION MAY NOT APPLY TO YOU.

THIS WARRANTY GIVES YOU SPECIFIC LEGAL RIGHTS, AND YOU MAY ALSO HAVE OTHER RIGHTS WHICH VARY FROM STATE TO STATE.

Copyright © Wagner Spray Tech Corporation, 1991. All rights reserved, including right of reproduction in whole or in part, in any form. Printed in U.S.A.



Wagner Spray Tech Corporation
1770 Fernbrook Lane
Minneapolis, Minnesota 55447
Telephone (612) 553-7000