

VersaSTUDIO

BN-20D Direct-to-Film Printer
Master Sales Guide



Table of Contents

Project Purpose.....	3
Need to Know.....	5
Target Markets & Applications	6
Workflow.....	10
Product Features.....	11
Print Speeds.....	13
Specifications.....	14

Project Purpose

As the custom decorated apparel market continues to grow and evolve, there has been a shift in technology in emerging markets over the last several years. In the DGA market, including Canada and Latin America, we have seen rapid growth in “DTF” solutions, with more manufacturers and distributors displaying a variety of systems at each consecutive trade-show.

While feedback received from customers has shown that the application is in high demand, it comes with growing pains as most of the entry to mid-level production systems have a reputation for being unreliable. Customers have expressed frustration over wasted time due to the manual interference required to get the systems operational at the start of each day.

The BN-20D Direct-to-Film Printer has been designed with specific features to meet customer demands for increased efficiency and reliability by providing a stable platform backed with Roland DG’s industry-best Trouble-Free Warranty for extra peace of mind. Driven by powerful and user-friendly Roland DG VersaWorks® RIP software, the BN-20D promises to change the landscape of the “Direct-to-Film” market.

The BN-20D Direct-to-Film System complements Roland DGA’s existing family of compact, powerful VersaSTUDIO machines designed to help smaller home- or office-based print providers build their businesses. With their small footprint and impressive capabilities, these innovative desktop devices are uniquely designed to help start-up and growing print businesses take their operations to the next level.



What You Need to Know

The Roland DG VersaSTUDIO BN-20D Direct-to-Film-Printer is the newest addition to the BN-20 Series of desktop printers. The products within the VersaSTUDIO product family have become well known for their amazing print quality, versatility, and of course, Roland DG reliability.

Apparel applications continue to be a driving force behind the small business market segment and there has been a shift to direct transfer technology. The market is evolving at an astonishing rate and customers are demanding a system that is ultra-reliable, requires minimal user maintenance, and is backed by a single trusted manufacturer. Offering unmatched reliability and ease of use, the BN-20D Direct-to-Film system includes Roland DG's high-quality S-PG inks, transfer film, and adhesive powder all powered by Roland DG VersaWorks (each sold separately).



Pricing

- **BN-20D printer - \$6,495**
- **S-PG inks 220 ml (CMYK) \$57.99**
- **S-PG ink 220 ml White \$66.99**
- **S-Powder Direct –to-Film Powder \$38.99**
- **S-F164 Direct Transfer Film 20” x 164’ \$145.99**
- **Includes powerful, feature-filled Roland DG VersaWorks® 6 RIP software at no additional cost**
- **Optional GXS-24 Stand - \$304.99**

Warranty Information

- **One Trouble-Free Warranty .**
- **Warranty extensions available for up to three total years of coverage.**
- **Also, once you register, you qualify for a variety of benefits such as free online training and phone support.**

Target Markets and Applications

The BN-20D target market is custom-decorated apparel and accessories. Over half (56%) of customers using devices in the desktop or small-format market segment identify their business as an apparel-based business.

User feedback from current BN-20/20A customers shows "DTF" as a preferred solution to HTV. This is driven by the ability to create very detailed graphics, including fine text, that would otherwise be difficult and time-consuming to weed, mask and transfer. The BN-20D offers a direct-to-film system that eliminates the need for weeding and masking those difficult-to-transfer designs.

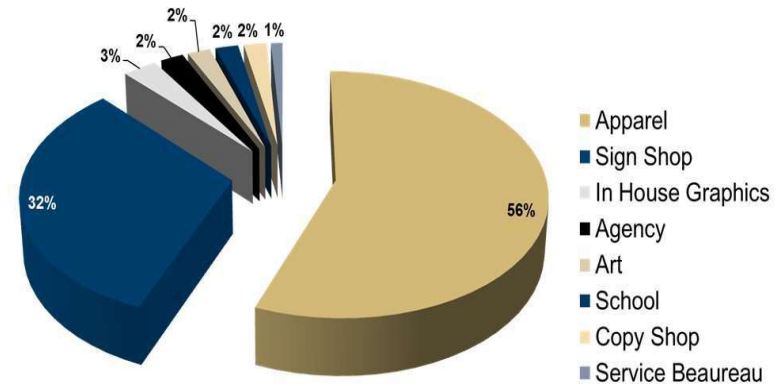

Desktop user survey



Applications

While many other devices on the market can create custom- decorated apparel using different technologies, one major advantage of the BN-20D Direct-to-Film Printer is its ability to print very detailed images and fine lines that would be difficult, or even impossible, to weed using vinyl.

Knocking out the backgrounds in the design and using the garment color as the background creates a soft, natural hand to the transfer.



Workflow

The BN-20D workflow can be customized by each user to best fit their business needs. With the diverse selection of curing units and heat presses, there is a solution to meet the needs of most any user.

Going from the printing phase to adding the S-Powder adhesive to final press is a simple process that creates stunning apparel transfers with ease.



1. Print to film with the BN-20D and S-PG inks, on S-F164 transfer film.



2. Apply shaking powder over the ink using S-POWDER.

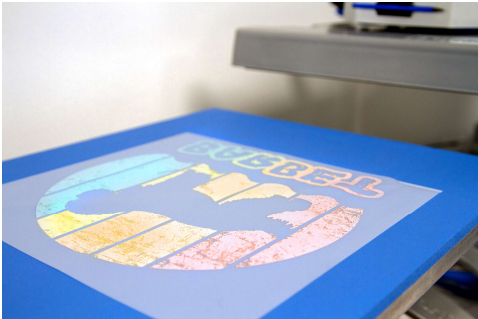

3. Melt powder under heat press at recommended time and temperature.



4. Heat press design to your fabric and remove the film backing.

Product Features

Amazing Image Quality

The VersaSTUDIO BN-20D uses **S-PG** ink in a standard CMYK+Wh configuration. Roland DG's S-PG offers a wide color gamut and amazing print quality when paired with S-F164 transfer film and S-PG-Powder. The complete system offers legendary Roland DG reliability, allowing users to create custom apparel transfers with confidence.

Variable dot control produces droplets of seven different sizes for precise, detailed graphics, excellent photographic reproduction, smooth gradations, and superb contrast. Roland Intelligent Pass Control precisely controls dot placement between passes, enabling the BN-20D printer to achieve smooth gradations, exceptional solid colors, and optimal image quality.



Variable Droplet Technology

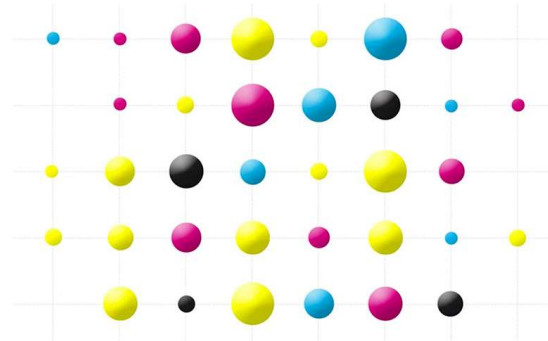

Product Features

Ink Recirculating System

The VersaSTUDIO BN-20D includes an updated ink delivery and recirculation system. The system is designed to ensure day-in and day-out reliability.

With dedicated channels for CMYK, plus an improved white ink delivery system, the BN-20D produces rich and vivid color while achieving optimal white ink opacity for light- and dark-colored garments and accessories.

BN-20 Ink Configuration

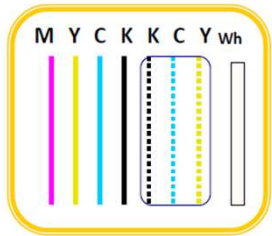

BN-20D Ink Configuration

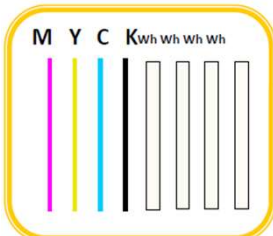

New four channel white ink delivery system

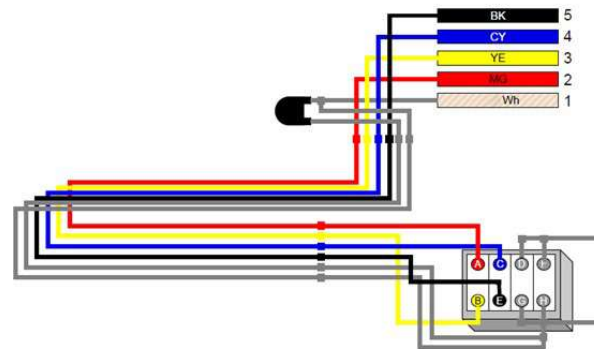
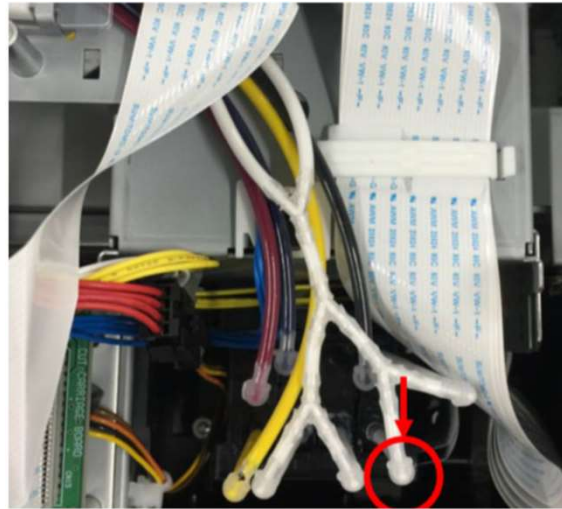

Product Features

Roland DG VersaWorks 6

Roland DG VersaWorks®, included with the BN-20D, has earned a reputation for being the world's most user-friendly and feature-packed RIP software. Incorporating the HARLEQUIN RIP dual-core engine and other innovative features, VersaWorks 6 offers quick RIP speeds as well the ability to handle and correctly process complex PDF, EPS, and PS files with drop shadows and transparencies.

VersaWorks 6 includes a modern, intuitive interface. Simply drag and drop files from the desktop, or other folder locations, into the printer queue for processing. The icon-based RIP experience allows the user to quickly access powerful tools for layout, quality and color management settings, easy nesting operations, and advanced job management.

Powerful Color Control

VersaWorks 6 supports comprehensive color libraries, including Roland Color System and PANTONE® libraries, giving you detailed spot color matching and automated color matching of logos and other design elements. VersaWorks 6 also allows for in-RIP spot color replacement on the fly, making color replacement as simple as a few clicks of the mouse. This is especially useful when duplicating targeted brand and sports logo colors for apparel.



PANTONE® Library and Roland Color System

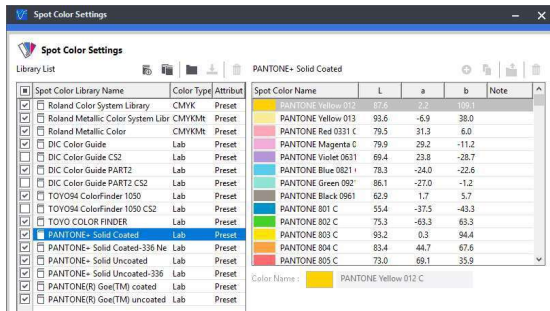

Spot Color Replacement

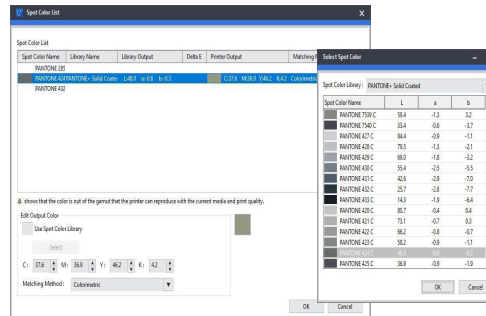

Product Features

Roland DG VersaWorks 6

Roland DG VersaWorks includes profile templates optimized for both light and dark garments specific to the BN-20D. Each template is designed to jet CMYK and White layers with the correct density and opacity to create stunning transfers on any color garment.

Powerful Roland DG VersaWorks includes a “Special Color Plate Generation” tool that allows users to easily add white ink data directly in the RIP. This advanced feature includes positional correction and size correction or “choke” to avoid any misalignment or visible white ink bleed on the finished graphic. This tool is a powerful time saver and further enhances the device’s ease of use.

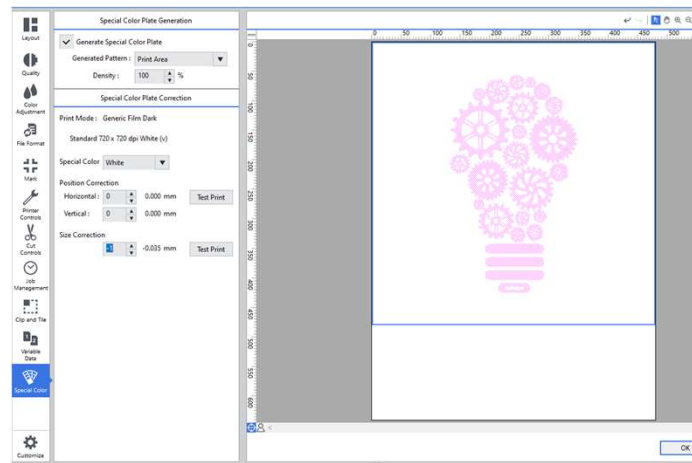
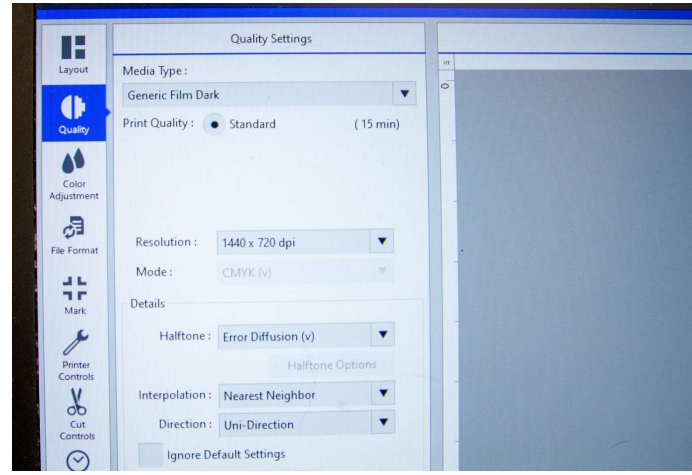

Product Features

CAD Cut Vinyl

While the direct transfer process does not require integrated print and cut for the application, the VersaSTUDIO BN-20D can be used as a stand-alone vinyl cutter to expand the customer's application offerings. Roland DG VersaWorks makes going from DTS transfer printing to CAD Cut vinyl cutting simple.

To make the switch, in Roland DG VersaWorks, simply turn off the print function under the "Cutting Controls" tab and change the selection to "Cut Only." This will ensure that BN-20D will only see data requiring a contour cut.

The "Job Assistant" function can be used as an added convenience feature for creating contour cut lines directly in the RIP when a PDF file is being used.



Print & Cut

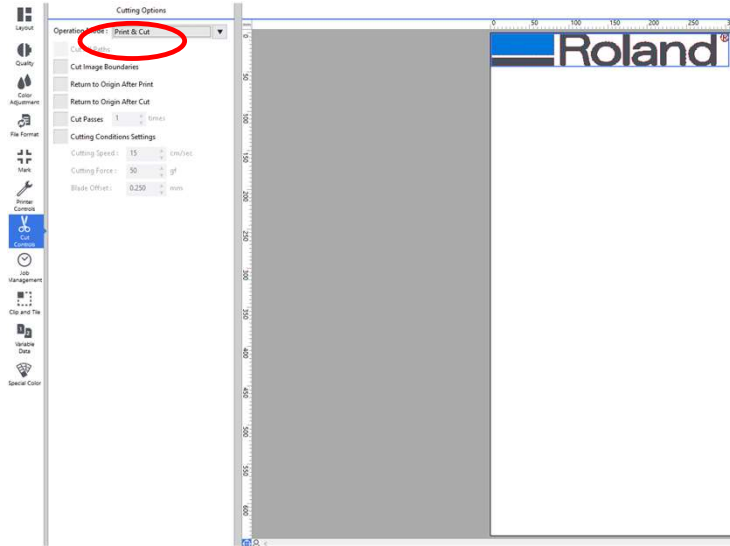

Job Assistant

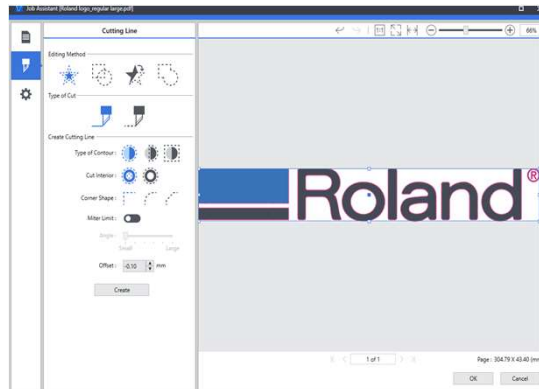

Cut Only

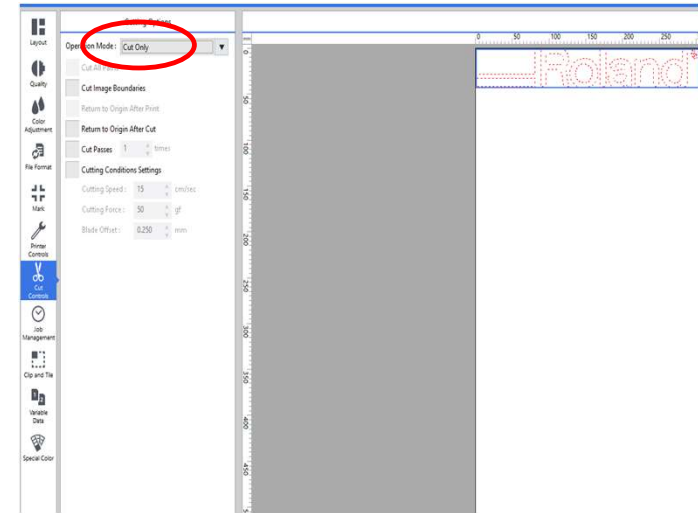

Product Features

Versatile Roll Accommodation

Roland DG's S-F164 Direct Transfer Film is available in 20-inch rolls to maximize productivity. The BN-20D can also accommodate various roll sizes from third-party manufacturers, ranging from as small as 6.7 inches up to 20.3 inches. While the BN-20D offers a complete solution, the device also gives customers the flexibility to use the solution that works best for their specific business needs.

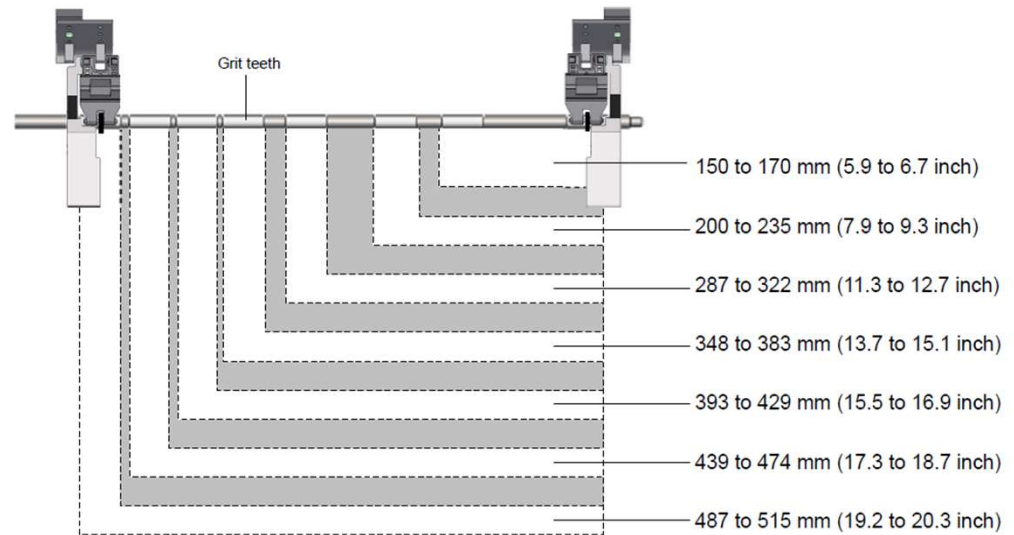
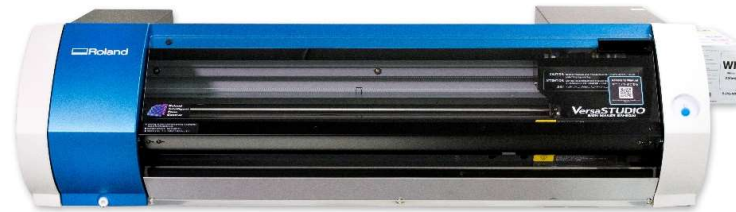

Print Speed

CMYK*

Print Quality	Resolution [dpi]	Bi/Uni	Pass	Print Speed [ft ² /h]
Standard	1440 x 1080	Bi/Uni	18	5.8
High Speed	720 x 720	Bi/Uni	12	8.4

White

Print Quality	Resolution [dpi]	Bi/Uni	Pass	Print Speed [ft ² /h]
Standard	720 x 720	Bi	12	16.7

* Additional CMYK modes to be added

Specifications

Items		BN-20D (Direct-to-Film)	BN-20 (Eco-solvent)
Size		→	39.7" W x 22.9" D x 11.53 H
Number of Ink Slot		→	5
Ink	Ink technology	Pigment	solvent
	Case, Capacity	→	220ml cartridge
	Ink type	CYMK + Wh	CYMK + Wh or Mt
Option parts (DTF)	Film	S-F164 film S-Powder	-
Cleaning Liquid		CJ-CL*	-
Maintenance	Cap Top	User replaceable	-
	Cap Top Replacement Sequence	User Replaceable from Utility	-
	Wiper	→	User Replaceable
	Felt Wiper	→	User Replaceable
	Manual Cleaning	Every day after the end of the workday	Recommended once a month
Installation		Self-Installation	-

תודה
Dankie Gracias
Спасибо شكراً
Merci Takk
Köszönjük Terima kasih
Grazie Dziękujemy Děkojame
Ďakujeme Vielen Dank Paldies
Kiitos Täname teid 谢谢
Thank You Tak
感謝您 Obrigado Teşekkür Ederiz
Σας Ευχαριστούμ 감사합니다
Bedankt Дěkujeme vám
ありがとうございます
Tack