

MODELA

MDX-50

Setup Guide

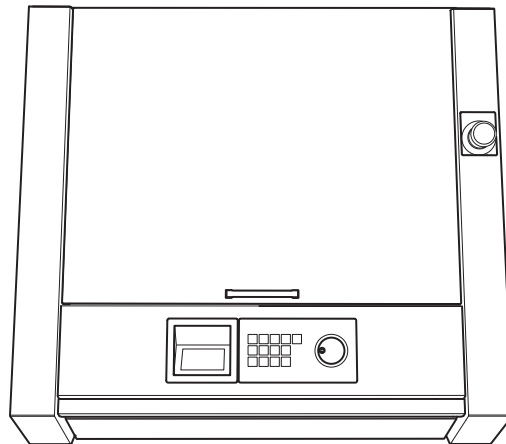

Thank you very much for purchasing this product.

- To ensure correct and safe usage with a full understanding of this product's performance, be sure to read through this document completely and store it in a safe location.
 - Unauthorized copying or transferal, in whole or in part, of this document is prohibited.
 - The contents of this document and the specifications of this product are subject to change without notice.
 - This product and this document have been prepared and tested as much as possible. If you find any misprints or errors, please inform us.
 - Roland DG Corporation assumes no responsibility for any direct or indirect loss or damage that may occur through use of this product, regardless of any failure to perform on the part of this product.
 - Roland DG Corporation assumes no responsibility for any direct or indirect loss or damage that may occur with respect to any article made using this product.
-

Roland DG Corporation



Applicable EMC Standards: EN 61326-1 (Class A), EN 55011 (Class A, Group 1), EN 61000-3-2, EN 61000-3-3

This product is a Class A device.

Radio interference may occur if this product is used in a residential environment. In such cases, users of this product may need to implement appropriate measures.

This product is a Group 1 device.

Radio frequency energies in the form of electromagnetic radiation, induction, and/or electrostatic bonding are not used nor deliberately emitted when processing material or during examination/analysis.

Roland DG Corporation has licensed the MMP technology from the TPL Group.

For the USA

FEDERAL COMMUNICATIONS COMMISSION RADIO FREQUENCY INTERFERENCE STATEMENT

This equipment has been tested and found to comply with the limits for a Class A digital device, pursuant to Part 15 of the FCC Rules.

These limits are designed to provide reasonable protection against harmful interference when the equipment is operated in a commercial environment.

This equipment generates, uses, and can radiate radio frequency energy and, if not installed and used in accordance with the instruction manual, may cause harmful interference to radio communications.

Operation of this equipment in a residential area is likely to cause harmful interference in which case the user will be required to correct the interference at his own expense.

Unauthorized changes or modification to this system can void the users authority to operate this equipment.

Use only I/O cables that have been designed and manufactured specifically for this device.

For Canada

CAN ICES-3 (A)/NMB-3(A)

For California

WARNING

This product contains chemicals known to cause cancer, birth defects and other reproductive harm, including lead.

For EU Countries



Manufacturer:

ROLAND DG CORPORATION

1-6-4 Shinmiyakoda, Kita-ku, Hamamatsu-shi, Shizuoka-ken, 431-2103 JAPAN

The authorized representative in the EU:

Roland DG EMEA, S.L.

Parc Tecnologic del Valles C/ Ceramistes, 6 08290 Cerdanyola del Valles / Barcelona Spain

For EU Countries

WARNING

This is a Class A product. In a domestic environment this product may cause radio interference in which case the user may be required to take adequate measures.

NOTICE

Grounding Instructions

In the event of a malfunction or breakdown, grounding provides a path of least resistance for electric current to reduce the risk of electric shock. This tool is equipped with an electric cord having an equipment-grounding conductor and a grounding plug. The plug must be plugged into a matching outlet that is properly installed and grounded in accordance with all local codes and ordinances.

Do not modify the plug provided - if it will not fit the outlet, have the proper outlet installed by a qualified electrician.

Improper connection of the equipment-grounding conductor can result in a risk of electric shock. The conductor with insulation having an outer surface that is green with or without yellow stripes is the equipment-grounding conductor. If repair or replacement of the electric cord or plug is necessary, do not connect the equipment-grounding conductor to a live terminal.

Check with a qualified electrician or service personnel if the grounding instructions are not completely understood, or if in doubt as to whether the tool is properly grounded.

Use only 3-wire extension cords that have 3-prong grounding plugs and 3-pole receptacles that accept the tool's plug.

Repair or replace damaged or worn cord immediately.

Operating Instructions

KEEP GUARDS IN PLACE and in working order.

REMOVE ADJUSTING KEYS AND WRENCHES. Form habit of checking to see that keys and adjusting wrenches are removed from tool before turning it on.

KEEP WORK AREA CLEAN. Cluttered areas and benches invite accidents.

DON'T USE IN DANGEROUS ENVIRONMENT. Don't use power tools in damp or wet locations, or expose them to rain. Keep work area well lighted.

KEEP CHILDREN AWAY. All visitors should be kept safe distance from work area.

MAKE WORKSHOP KID PROOF with padlocks, master switches, or by removing starter keys.

DON'T FORCE TOOL. It will do the job better and safer at the rate for which it was designed.

USE RIGHT TOOL. Don't force tool or attachment to do a job for which it was not designed.

USE PROPER EXTENSION CORD. Make sure your extension cord is in good condition. When using an extension cord, be sure to use one heavy enough to carry the current your product will draw. An undersized cord will cause a drop in line voltage resulting in loss of power and overheating.

WEAR PROPER APPAREL. Do not wear loose clothing, gloves, neckties, rings, bracelets, or other jewelry which may get caught in moving parts. Nonslip footwear is recommended. Wear protective hair covering to contain long hair.

USE SAFETY GLASSES, face or dust mask if cutting or cleaning operation is dusty. Everyday eyeglasses only have impact resistant lenses, they are NOT safety glasses.

SECURE WORK. Use clamps or a vise to hold work when practical.

DON'T OVERREACH. Keep proper footing and balance at all times.

MAINTAIN TOOLS WITH CARE. Keep tools sharp and clean for best and safest performance. Follow instructions for lubricating and changing accessories.

DISCONNECT TOOLS before servicing; when changing accessories, such as blades, bits, cutters, and the like.

REDUCE THE RISK OF UNINTENTIONAL STARTING. Make sure switch is in off position before plugging in.

USE RECOMMENDED ACCESSORIES. Consult the owner's manual for recommended accessories. The use of improper accessories may cause risk of injury to persons.

NEVER STAND ON TOOL. Serious injury could occur if the tool is tipped or if the cutting tool is unintentionally contacted.

CHECK DAMAGED PARTS. Before further use of the tool, a guard or other part that is damaged should be carefully checked to determine that it will operate properly and perform its intended function - check for alignment of moving parts, binding of moving parts, breakage of parts, mounting, and any other conditions that may affect its operation. A guard or other part that is damaged should be properly repaired or replaced.

NEVER LEAVE TOOL RUNNING UNATTENDED. TURN POWER OFF. Don't leave tool until it comes to a complete stop.

USE POWER SUPPLY CORD WHICH IS ATTACHED WITH PRODUCTS. do not use other power supply cord.

PERFORM CLEANING USING A DUST COLLECTOR OR A COMMERCIALY AVAILABLE BRUSH. Never use a solvent such as gasoline, alcohol, or thinner to perform cleaning.

CONNECT THE USB CABLE TO THE COMPUTER (Certified with IEC/EN60950-1) with the suitable flammability rating which was estimated by IEC/EN61010-1 3rd Edition (Cl. 9).

USE AN EXTERNAL CABLE AND A DUST COLLECTOR with the suitable flammability rating which was estimated by IEC/EN61010-1 3rd Edition (Cl. 9).

For China

产品中有毒有害物质或元素的名称及含量

部件名称	有毒有害物质或元素					
	铅(Pb)	汞(Hg)	镉(Cd)	六价铬 (Cr(VI))	多溴联苯 (PBB)	多溴二苯醚 (PBDE)
印刷电路板	×	○	×	○	○	○
头部	×	○	○	○	○	○
壳体、底架	×	○	○	○	○	○
电源	×	○	×	○	○	○
其他(电缆、附件等)	×	○	○	○	○	○

○：表示该有毒有害物质在该部件所有均质材料中的含量均在 GB/T26572-2011 标准规定的限量要求以下。
 ×：表示该有毒有害物质至少在该部件的某一均质材料中的含量超出 GB/T26572-2011 标准规定的限量要求。

环保使用期限



此标志适用于在中国国内销售的电子信息产品，表示环保使用期限的年数。所谓环保使用期限是指在自制造日起的规定期限内，产品中所含的有害物质不致引起环境污染，不会对人身、财产造成严重的不良影响。环保使用期限仅在遵照产品使用说明书，正确使用产品的条件下才有效。不当的使用，将会导致有害物质泄漏的危险。

For EU countries



This product must be disposed of separately at your local waste recycling center. Do not dispose of in household waste bin.



Lever dit product in bij een lokaal afvalverzamelpunt. NIET met normaal huishoudelijk afval afvoeren.



Bitte führen Sie dieses Produkt separat Ihrer örtlichen Entsorgungsstelle zu. Bitte nicht mit dem normalen Hausmüll entsorgen.



Dette Produkt skal smides særskilt væk på den lokale affalds- og genbrugsstation. Må ikke smides ud sammen med almindeligt husholdningsaffald.



Ne jetez pas le produit avec vos ordures ménagères. Portez-le dans un centre recyclage des déchets.



Tätä tuotetta ei saa hävittää normaalien talousjätteiden mukana, vaan se on toimitettava ongelmajätteiden keräilypisteeseen hävitettäväksi.



Questo prodotto deve essere smaltito negli appositi contenitori per la raccolta differenziata, non buttare nel cestino dei rifiuti casalinghi.



Produkten måste kasseras separat på din lokala återvinningscentral. Släng inte produkten tillsammans med hushållssoporna.



Este producto debe devolverse al centro de reciclaje más cercano a su domicilio para su correcta eliminación. No lo tire a la basura.



Μην πετάξετε το αντικείμενο αυτό στο καλάθι των απορριμμάτων. Αφαιρέστε τις μπαταρίες και προσκομίστε το στο τοπικό κέντρο ανακύκλωσης.



Deite fora separadamente este produto no seu centro de reciclagem local. Não o deite fora no seu caixote do lixo.

Contents

Contents	4
⚠ To Ensure Safe Use	5
⚠ Pour utiliser en toute sécurité	11
Important Notes on Handling and Use	17
Installing the Machine	18
Step 1: Deciding on an Installation Site	18
Step 2: Removing the Retainers	20
Machine Highlights	21
Features of This Machine	21
Operating the Machine	21
Documentation Included with the Machine	21
Part Names and Functions	22
Front	22
Inside the Machine	22
Side	24
Performing an Emergency Stop on This Machine	25
Emergency Stop	25
Emergency Stop or Pause Due to Opening or Closing the Cover	26
Emergency Stop Due to Opening or Closing the Cover	26
Pause Due to Opening or Closing the Cover	27
Preparing the Machine for Use	28
Step 1: Checking the Included Items	28
Step 2: Installing the Roland DG Software Package	29
Step 3: Connecting the Cable	32
Step 4: Switching On the Machine's Power Switch (Setting the Panel Display Language)	33
Step 5: Connecting the Machine to a Computer Using a USB Cable	34
Step 6: Starting VPanel	35
Step 7: Performing Spindle Run-in	36
Step 8: Correcting the Machine (Automatic Correction)	37
Step 9: Exiting VPanel	39
Step 10: Switching Off the Machine's Power	39
Machine Specifications	40
Power Rating and Serial Number Location	40
Expansion Port Specifications	40
Dimensional Drawings	44
Specifications	46
System Requirements for USB Connection	46

Company names and product names are trademarks or registered trademarks of their respective holders.

Copyright © 2016-2017 Roland DG Corporation



<http://www.rolanddg.com/>





To Ensure Safe Use

Improper handling or operation of this machine may result in injury or damage to property. Points that must be observed to prevent such injury or damage are described as follows.

About ⚠ WARNING and ⚠ CAUTION Notices

 WARNING	Used for instructions intended to alert the user to the risk of death or severe injury should the unit be used improperly.
 CAUTION	Used for instructions intended to alert the user to the risk of injury or material damage should the unit be used improperly. * Material damage refers to damage or other adverse effects caused with respect to the home and all its furnishings, as well as to domestic animals or pets.

About the Symbols

	The ⚠ symbol alerts the user to important instructions or warnings. The specific meaning of the symbol is determined by the design contained within the ⚠ symbol. The symbol on the left means "danger of electrical shock."
	The ⓧ symbol alerts the user to items that must never be carried out (are forbidden). The specific meaning of the symbol is determined by the design contained within the ⓧ symbol. The symbol on the left means "the unit must never be disassembled."
	The ● symbol alerts the user to things that must be carried out. The specific meaning of the symbol is determined by the design contained within the ● symbol. The symbol on the left means "the power-cord plug must be unplugged from the outlet."

 **Incorrect operation may cause injury**

 **WARNING**

 **Always unplug the power cord when attaching or removing parts and optional parts and when performing maintenance that does not require the machine to be connected to a power source.**

Attempting such operations while the machine is connected to a power source may result in injury or electrical shock.

 **Keep children away from the machine.**
The machine includes areas and components that pose a hazard to children and may result in injury, blindness, choking, or other serious accidents.

 **Never attempt to disassemble, repair, or modify the machine.**
Doing so may result in fire, electrical shock, or injury. Entrust repairs to a trained service technician.

 **Be sure to follow the operation procedures described in the user's manual. Never allow anyone unfamiliar with the usage or handling of the machine to touch it.**
Incorrect usage or handling may lead to an accident.

 **Never operate the machine while tired or after ingesting alcohol or any medication.**
Operation requires unimpaired judgment. Operating the machine with impaired judgment may result in an accident.

 **WARNING**

 **Conduct operations in a clean, brightly lit location.**

Working in a location that is dark or cluttered may lead to an accident, such as becoming caught in the machine as the result of an inadvertent stumble.

 **Be careful around the cutting tool.**
The cutting tool is sharp. Broken cutting tools are also dangerous. To avoid injury, exercise caution.

 **Never use a cutting tool that has become dull. Perform frequent maintenance to keep the machine in good working order.**
Inappropriate usage may result in fire or injury.

 **CAUTION**

 **Never climb or lean on the machine.**
The machine is not made to support a person. Climbing or leaning on the machine may dislodge components and cause them to fall off the machine.

 **Never operate the machine if the cover is cracked or broken.**
Doing so may result in injury. If the cover is cracked or broken, contact your authorized Roland DG Corporation dealer.

Danger of electrical short, electrical shock, or fire

WARNING

 **Connect this machine to a power outlet that complies with this machine's ratings (for voltage, frequency, and current).**
Incorrect voltage or insufficient current may cause fire or electrical shock.

 **If sparks, smoke, burning odors, abnormal noise, or abnormal operations occur, immediately unplug the power cord. Never use the machine if any component is damaged.**
Continuing to use the machine may result in fire, electrical shock, or injury. Contact your authorized Roland DG Corporation dealer.

 **Never use the machine outside or in any location where exposure to water or high humidity may occur. Do not touch the power cord, plug, or electrical outlet with wet hands.**
Doing so may result in fire or electrical shock.

 **Never allow any foreign object to get inside the machine. Never expose the machine to liquid spills.**
Inserting objects such as coins or matches or allowing beverages to be spilled into the ventilation ports may result in fire or electrical shock. If anything gets inside, immediately disconnect the power cord and contact your authorized Roland DG Corporation dealer.

 **Never place any flammable object nearby. Never use a combustible aerosol spray nearby. Never use the machine in any location where gases can accumulate.**
Combustion or explosion may occur.

 **Handle the power cord, plug, and power outlet correctly and with care. Never use any article that is damaged.**
Using a damaged article may result in fire or electrical shock.

WARNING

 **When using an extension cord or power strip, use one that adequately satisfies the machine's ratings (for voltage, frequency, and current).**
Use of multiple electrical loads on a single power outlet or use of a lengthy extension cord may cause fire.

 **Position the machine so that the power plug is within immediate reach at all times.**
This is to enable quick disconnection of the power plug in the event of an emergency. Install the machine next to a power outlet. Also, provide enough empty space to allow immediate access to the power outlet.

 **For accessories (optional and consumable items, power cord, and the like), use only genuine articles compatible with this machine.**
Incompatible items may lead to an accident.

 **Never use the machine for any purpose for which it is not intended or use the machine in an excessive manner that exceeds its capacity.**
Doing so may result in injury or fire.

 **Do not use the supplied power cord for other products.**

 **If the machine will not be used for a long period, disconnect the power cord.**
This prevents an accident caused by unexpected electric leakage or unintentional start of the machine.

 **Connect the machine to ground.**
This can prevent fire or electrical shock due to electric leakage in the event of a malfunction.

WARNING



Never use cutting oil.

This machine is not designed for the flow of cutting oil. Oil may get inside the machine and cause fire or electrical shock.



Never use a pneumatic blower.

This machine is not compatible with a pneumatic blower. Cutting waste may get inside the machine and cause fire or electrical shock.



Important Notes about the Power Cord, Plug, and Power Outlet

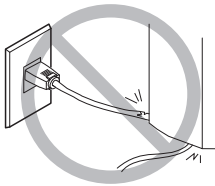

Never place any object on top or subject to damage.

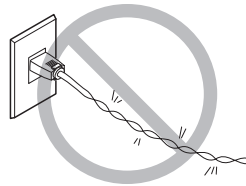

Never bend or twist with excessive force.



Never pull with excessive force.

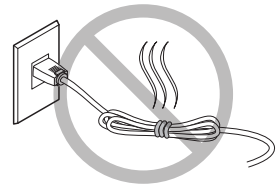

Never bundle, bind, or roll up.

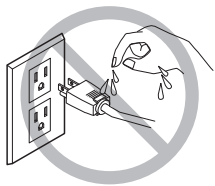

Never allow to get wet.

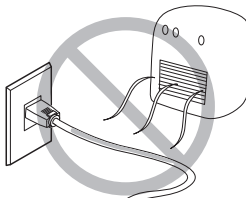

Never make hot.

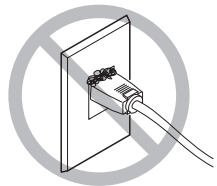

Dust may cause fire.



This is a heavy machine



CAUTION



Unloading and placement are operations that must be performed by 4 people or more.

Tasks that require undue effort when performed by a small number of people may result in physical injury. Dropping the machine may result in injury.



CAUTION





Install the machine in a location that is level, stable, and able to bear the weight of the machine.

The total weight of the machine may reach 140 kg (309 lb.) or more. Installation in an unsuitable location may cause a major accident, including tip over, fall, or collapse.

 **Cutting waste and workpieces are flammable and toxic.**

 **WARNING**

 **Never attempt to cut magnesium or any other such flammable material.**
Fire may occur during cutting.

 **Never attempt to cut metal, carbon, or any other such conductive material.**
Fire may occur during cutting.

 **Keep open flame away from the work area.**
Cutting waste may ignite. Powdered material is extremely flammable, and even metal material may catch fire.

 **When using a vacuum cleaner to take up cutting waste, exercise caution to prevent fire or dust explosion.**
Taking up fine cuttings using an ordinary vacuum cleaner may cause danger of fire or explosion. Check with the manufacturer of the vacuum cleaner. When the safety of use cannot be determined, clean the machine using a brush or the like, without using a vacuum cleaner.

 **CAUTION**

 **Wear dust goggles and a mask. Wash away any cutting waste remaining on the hands.**
Accidentally swallowing or inhaling cutting waste may be hazardous to your health.

 **Danger of pinching, entanglement, and burns**

 **WARNING**

 **Securely fasten the cutting tool and workpiece in place. After securing these items in place, make sure no wrenches or other articles have inadvertently been left behind.**
If you do not check for these articles, they may be thrown from the machine with force, posing a risk of injury.

 **Do not touch the spindle unit or the surrounding areas immediately after cutting has ended.**
Doing so may result in burns.

 **WARNING**

 **Exercise caution to avoid being pinched or becoming entangled in the machine.**
Inadvertent contact with certain areas may cause your hand or fingers to be pinched or become entangled in the machine. Use care when performing operations.

 **CAUTION**

 **Never attempt operation while wearing a necktie, a necklace, loose clothing, or gloves. Bind long hair securely.**
Such items may become caught in the machine, resulting in injury.

Warning labels

Warning labels are affixed to make areas of danger immediately clear. The meanings of these labels are as follows. Be sure to heed their warnings. Also, never remove the labels or allow them to become obscured.

Front



Caution: Sharp Tool
The cutting tool has a sharp point. Inadvertent contact may cause injury.



Caution: High Temperature
Do not touch the spindle unit or the surrounding areas immediately after cutting has ended. Doing so may result in burns.

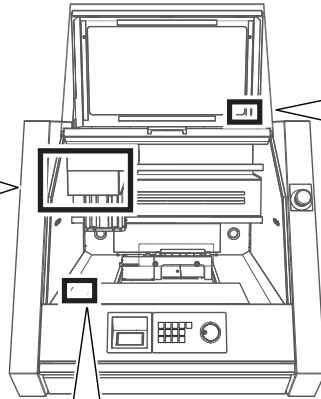

Caution: Pinching Hazard
Exercise caution to prevent fingers from being pinched when closing covers.



Never use a pneumatic blower.
This machine is not compatible with pneumatic blowers. Cutting waste may get inside the machine and cause fire or electrical shock.

Back

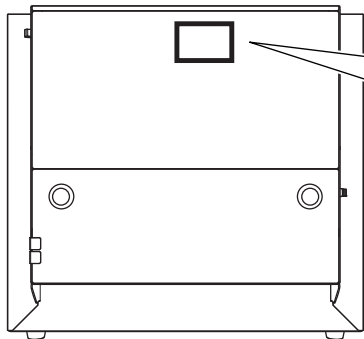



Caution: High Voltage
Removing the cover may result in high-voltage electric shock.











Pour utiliser en toute sécurité

La manipulation ou l'utilisation inadéquate de cet appareil peuvent causer des blessures ou des dommages matériels. Les précautions à prendre pour prévenir les blessures ou les dommages sont décrites ci-dessous.

⚠ Avis sur les ⚠ avertissements

 ATTENTION	Utilisé pour avertir l'utilisateur d'un risque de décès ou de blessure grave en cas de mauvaise utilisation de l'appareil.
 PRUDENCE	Utilisé pour avertir l'utilisateur d'un risque de blessure ou de dommage matériel en cas de mauvaise utilisation de l'appareil. * Par dommage matériel, il est entendu dommage ou tout autre effet indésirable sur la maison, tous les meubles et même les animaux domestiques.

À propos des symboles

	Le symbole  attire l'attention de l'utilisateur sur les instructions importantes ou les avertissements. Le sens précis du symbole est déterminé par le dessin à l'intérieur du symbole  . Le symbole à gauche signifie « danger d'électrocution ».
	Le symbole  avertit l'utilisateur de ce qu'il ne doit jamais faire, ce qui est interdit. Le sens précis du symbole est déterminé par le dessin à l'intérieur du symbole  . Le symbole à gauche signifie que l'appareil ne doit jamais être démonté.
	Le symbole  prévient l'utilisateur sur ce qu'il doit faire. Le sens précis du symbole est déterminé par le dessin à l'intérieur du symbole  . Le symbole à gauche signifie que la fiche du câble d'alimentation doit être débranchée de la prise.

Une utilisation incorrecte peut causer des blessures

ATTENTION

 **Toujours débrancher le câble d'alimentation lors de la fixation ou du retrait de pièces et de pièces en option et du nettoyage ou des travaux d'entretien qui n'exigent pas un branchement de l'appareil à une source d'alimentation.**

Tenter ces opérations pendant que l'appareil est branché à une source d'alimentation peut causer des blessures ou un choc électrique.

 **Garder les enfants loin de l'appareil.**
L'appareil comporte des parties et des composants qui présentent un danger pour les enfants et qui peuvent causer des blessures, la cécité, la suffocation ou d'autres accidents graves.

 **Ne jamais tenter de démonter, de réparer ou de modifier l'appareil.**
Le non-respect de cette consigne peut provoquer un incendie, un choc électrique ou des blessures. Confier les réparations à un technicien ayant la formation requise.

 **S'assurer de suivre les procédures d'utilisation décrites dans le manuel utilisateur. Ne jamais permettre à quiconque ne connaissant pas le fonctionnement ou la manutention de l'appareil de le toucher.**
L'utilisation ou la manutention incorrectes peuvent causer un accident.

 **Ne jamais faire fonctionner l'appareil après avoir consommé de l'alcool ou des médicaments, ou dans un état de fatigue.**
L'utilisation de l'appareil exige un jugement sans faille. L'utilisation avec les facultés affaiblies peut entraîner un accident.

ATTENTION

 **Utiliser l'appareil dans un endroit propre et bien éclairé.**

Travailler dans un endroit sombre ou encombré peut entraîner un accident; l'utilisateur risque, par exemple, de trébucher malencontreusement et d'être coincé par une partie de l'appareil.

 **Être attentif dans le périmètre de l'outil de coupe.**

L'outil de coupe est acéré. Les outils de coupes brisés sont aussi dangereux. Faire preuve de prudence pour éviter les blessures.

 **Ne jamais utiliser un outil de coupe émoussé. Procéder fréquemment aux travaux d'entretien pour garder l'appareil en bon état de fonctionnement.**

L'usage inapproprié peut causer un incendie ou des blessures.

PRUDENCE

 **Ne jamais grimper ni s'appuyer sur la machine.**

La machine n'est pas conçue pour supporter le poids d'une personne. Grimper ou s'appuyer sur la machine peut déplacer des éléments et causer un faux pas ou une chute, ce qui causerait des blessures.

 **Ne pas utiliser si un couvercle avant est fissuré ou brisé.**

Vous risqueriez de vous blesser. Si le couvercle est fissuré ou brisé, communiquer avec le représentant Roland DG autorisé.

 **Risque de court-circuit, d'électrocution ou d'incendie**

 **ATTENTION**



Brancher à une prise électrique conforme aux caractéristiques de cet appareil (tension, fréquence et courant).

Une tension incorrecte ou un courant insuffisant peuvent causer un incendie ou un choc électrique.



S'il se produit des étincelles, de la fumée, une odeur de brûlé, des bruits inhabituels ou un fonctionnement anormal, débrancher immédiatement le câble d'alimentation. Ne jamais utiliser l'appareil si un composant est endommagé.

Continuer à utiliser l'appareil peut causer un incendie, un choc électrique ou des blessures. Communiquer avec le représentant Roland DG Corp. autorisé.



Ne jamais utiliser l'appareil à l'extérieur ni à un endroit où il risque d'être exposé à l'eau ou à une forte humidité. Ne pas toucher le câble d'alimentation, la fiche ou la prise électrique avec des mains mouillées.

Le non-respect de cette consigne peut provoquer un incendie ou un choc électrique.



Ne jamais insérer d'objet étranger dans l'appareil. Ne jamais exposer l'appareil aux déversements de liquides.

L'insertion d'objets comme des pièces de monnaie ou des allumettes ou le déversement de liquides dans les orifices de ventilation peuvent causer un incendie ou un choc électrique. Si un objet ou du liquide s'infiltré dans l'appareil, débrancher immédiatement le câble d'alimentation et communiquer avec le représentant Roland DG autorisé.



Ne jamais placer d'objet inflammable à proximité de l'appareil. Ne jamais utiliser de produit inflammable en aérosol à proximité de l'appareil. Ne jamais utiliser l'appareil dans un endroit où des gaz peuvent s'accumuler.

Une combustion ou une explosion peuvent se produire.

 **ATTENTION**



Manipuler le câble d'alimentation, la fiche et la prise électrique correctement et avec soin. Ne jamais utiliser un article endommagé,

car cela pourrait causer un incendie ou un choc électrique.



Si une rallonge ou une bande d'alimentation électrique sont utilisées, s'assurer qu'elles correspondent aux caractéristiques de l'appareil (tension, fréquence et courant).

L'utilisation de plusieurs charges électriques sur une prise unique ou une longue rallonge peut causer un incendie.



Placer l'appareil de façon à ce que la fiche soit facile d'accès en tout temps.

Ainsi, l'appareil pourra être débranché rapidement en cas d'urgence. Installer l'appareil près d'une prise électrique. En outre, prévoir suffisamment d'espace pour que la prise électrique soit facile d'accès.



Utiliser uniquement des accessoires d'origine (accessoires en option, articles consommables, câble d'alimentation et autres articles semblables), compatibles avec l'appareil.

Les articles incompatibles risquent de causer des accidents.



Ne jamais utiliser l'appareil à des fins autres que celles pour lesquelles il est conçu. Ne jamais l'utiliser de manière abusive ou excessive.

Le non-respect de cette consigne peut provoquer des blessures ou un incendie.



Ne pas utiliser le cordon électrique fourni avec d'autres produits.

ATTENTION

 **Si l'appareil doit rester inutilisé pendant une longue période, débrancher le câble d'alimentation.**
Cela peut prévenir les accidents en cas de fuite de courant ou de démarrage accidentel.

 **Brancher l'appareil à la terre.**
La mise à la terre peut prévenir un incendie ou un choc électrique dus à une fuite de courant en cas de défaillance.

 **Ne jamais utiliser d'huile de coupe.**
Cet appareil n'est pas conçu pour traiter l'huile de coupe. L'huile peut s'infiltrer à l'intérieur de l'appareil et causer un incendie ou un choc électrique.

ATTENTION

 **Ne jamais utiliser d'air sous pression.**
Cet appareil n'est pas conçu pour être nettoyé à l'aide d'un appareil soufflant. Des rebuts de coupe peuvent s'infiltrer à l'intérieur et causer un incendie ou un choc électrique.

Remarques importantes à propos du câble d'alimentation, de la fiche et de la prise électrique

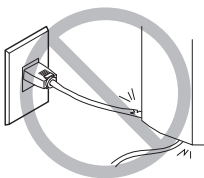

Ne jamais déposer aucun objet dessus au risque de les endommager.

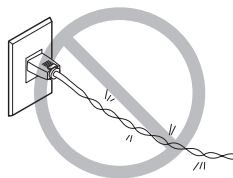

Ne jamais plier ni tordre avec une force excessive.

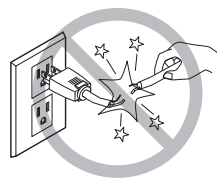

Ne jamais tirer avec une force excessive.

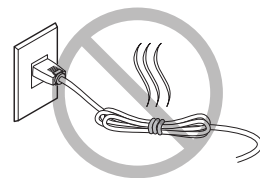

Ne jamais plier ni enrouler.



Ne jamais laisser mouiller.

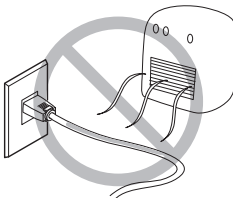

Ne jamais chauffer.

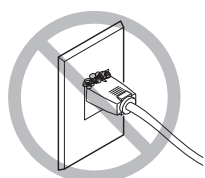

La poussière peut provoquer un incendie.

Cet appareil est lourd.

PRUDENCE

 **Le déchargement et la mise en place doivent être faits par au moins quatre personnes.**
Les tâches qui exigent un effort trop grand si elles sont exécutées par un petit nombre de personnes peuvent être cause de blessures. Échapper l'appareil peut causer des blessures.

PRUDENCE

 **Installer l'appareil à un endroit de niveau, stable et pouvant prendre en charge le poids l'appareil.**
Le poids total de la machine peut atteindre 140 kg (309 lb) ou plus. Installer l'appareil à un endroit inapproprié peut provoquer un accident grave tel qu'un renversement, une chute ou un écrasement.



Les rebuts et morceaux de la coupe sont inflammables et toxiques.



ATTENTION



Ne jamais tenter de couper du magnésium ni aucun autre matériau inflammable.
Un incendie peut se produire pendant la coupe.



Ne jamais essayer de couper du métal, du carbone ou tout autre métal conducteur.
Un incendie peut se produire pendant la coupe.



Garder toute flamme nue loin de l'espace de travail.
Les rognures de coupe peuvent s'enflammer. Les matériaux pulvérisés sont extrêmement inflammables. Les matériaux métalliques peuvent également s'enflammer.



ATTENTION



Si un aspirateur est utilisé pour ramasser les rognures de coupe, faire preuve de prudence pour empêcher que la poussière s'enflamme ou explose.

Ramasser des rognures fines à l'aide d'un aspirateur ordinaire peut créer un risque d'incendie ou d'explosion. Vérifier auprès du fabricant de l'aspirateur. Dans les cas où il est impossible de déterminer si un aspirateur peut être utilisé sans danger, nettoyer l'appareil à l'aide d'une brosse ou d'un article semblable plutôt que d'un aspirateur.



PRUDENCE



Porter des lunettes de protection et un masque. Rincer toutes les rognures de coupe qui pourraient rester collées aux mains.
Ingérer ou respirer accidentellement des rognures de coupe peut être dangereux pour la santé.



Certains éléments peuvent présenter un risque de pincement, d'emmêlement, de brûlure ou d'autres dangers.



ATTENTION



Fixer solidement l'outil de coupe et la pièce à travailler. Une fois qu'ils sont fixés solidement, s'assurer qu'aucun outil ni aucun autre objet n'a été laissé en place.

Si tel était le cas, ces objets peuvent être projetés avec force hors de l'appareil et causer des blessures.



Ne pas toucher l'outil de coupe ou les parties avoisinantes immédiatement après la coupe.

Le non-respect de cette consigne peut provoquer des brûlures.



ATTENTION



Faire preuve de prudence pour éviter l'écrasement ou le coincement dans l'appareil.

La main ou les doigts peuvent être écrasés ou coincés s'ils entrent accidentellement en contact avec certaines parties. Faire preuve de prudence lors de l'utilisation de l'appareil.



PRUDENCE



Ne jamais faire fonctionner l'appareil si l'on porte une cravate, un collier, des vêtements amples ou des gants. Bien attacher les cheveux longs.

Ces objets peuvent se retrouver coincés dans l'appareil, ce qui pourrait causer des blessures.

Vignettes d'avertissement

Des vignettes d'avertissement sont apposées pour qu'il soit facile de repérer les zones dangereuses. La signification des vignettes est donnée ci-dessous. Respecter les avertissements. Ne jamais retirer les vignettes et ou les laisser s'encrasser.

Avant

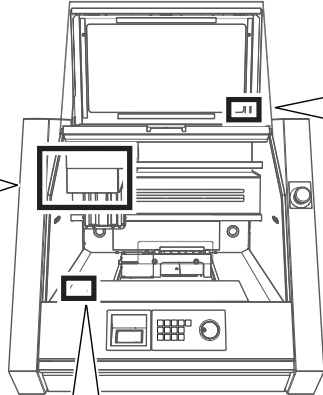



Prudence : Outil acéré
L'outil de coupe possède une pointe acérée. Un contact accidentel peut provoquer des blessures.



Prudence : Température élevée
Ne pas toucher l'outil de coupe ou les parties avoisinantes immédiatement après la coupe. Le non-respect de cette consigne peut provoquer des brûlures.

Prudence : Risque de pincement
Faire preuve de prudence pour éviter l'écrasement des doigts lors de la fermeture du couvercle.

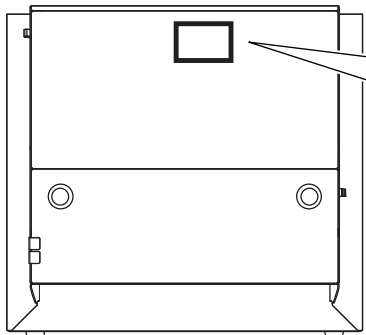
Ne jamais utiliser d'air sous pression.
Cet appareil n'est pas conçu pour être nettoyé à l'aide d'air sous pression. Des rebuts de coupe peuvent s'infiltrer à l'intérieur et causer un incendie ou un choc électrique.

Arrière



Prudence : Haute tension
Le retrait du couvercle peut provoquer un choc électrique de haute tension.

Important Notes on Handling and Use

This machine is a precision device. To ensure the full performance of this machine, be sure to observe the following important points. Failure to observe these may not only result in loss of performance but may also cause malfunction or breakdown.

This machine is a precision device.

- Handle this machine carefully and never subject it to impacts or excessive force.
- Carefully clean away cutting waste.
- Use this machine within the range of its specifications.
- Never attempt to move the spindle head or table by hand with undue force.
- Never needlessly touch anywhere inside the machine except for locations specified in this document.

Install this machine in a suitable location.

- Install this machine in a location that meets the specified conditions for temperature, humidity, and the like.
- Install this machine in a quiet, stable location offering good operating conditions.
- Never install this machine outside.
- Never use this machine in an environment where silicone substances (oil, grease, sprays, etc.) are present. Doing so may cause poor switch contact.

This machine becomes hot.

- Never cover this machine with cloth or a similar object or cover the gaps with tape.
- Install this machine in a well-ventilated location.

About tool burs

- Use an appropriate tool bur that matches the workpiece and the cutting method.
- The tip of the tool bur is breakable. Handle the tool bur with care, being careful not to drop it.

This machine is suited to cutting resins.

- Never use this machine to cut metal.

Installing the Machine

Step 1 : Deciding on an Installation Site

Placement and Installation

⚠ WARNING Unloading and placement are operations that must be performed by 4 people or more.

Tasks that require undue effort when performed by a small number of people may result in physical injury. Dropping the machine may result in injury.

The weight of the machine alone is 120 kg (265 lb.). Unload and place the machine with care.

• When lifting the machine, hold the locations indicated with the arrows in the following figure.

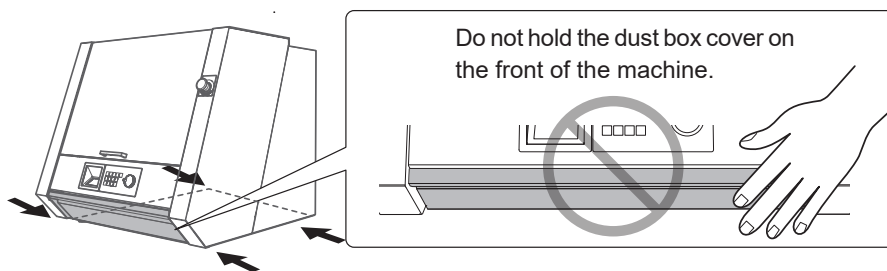

Installation Environment

Install the machine in a level, stable location offering good operating conditions. An unsuitable location can cause accidents, fire, faulty operation, or breakdown.

⚠ WARNING Install the machine in a location that is level, stable, and able to bear the weight of the machine.

The total weight of the machine may reach 140 kg (309 lb.) or more. Installation in an unsuitable location may cause a major accident, including tip over, fall, or collapse.

⚠ WARNING Never install the machine in a location exposed to open flame.

Cutting waste may ignite. Powdered material is extremely flammable, and even metal material may catch fire.

⚠ WARNING Never place any flammable object nearby. Never use a combustible aerosol spray nearby. Never use the machine in any location where gases can accumulate.

Combustion or explosion may occur.

⚠ WARNING Never use the machine outside or in any location where exposure to water or high humidity may occur. Do not touch the power cord, plug, or power outlet with wet hands.

Doing so may result in fire or electrical shock.

⚠ WARNING Install the machine so that the power plug is within immediate reach at all times.

This is to enable quick disconnection of the power plug in the event of an emergency. Install the machine next to a power outlet.

Also, provide enough empty space to allow immediate access to the power outlet.

- Never install the machine in a location subject to wide fluctuations in temperature or humidity.
- Never install the machine in a location subject to shaking or vibration.
- Never install the machine in a location where the floor is tilted, not level, or unstable.
- Never install the machine in a dusty or dirty location or outdoors.
- Never install the machine in a location exposed to direct sunlight or near air-conditioning or heating equipment.
- Never install the machine in a location exposed to considerable electrical or magnetic noise or other forms of electromagnetic energy.
- Never install the machine in an environment where silicone substances (oil, grease, sprays, etc.) are present. Doing so may cause poor switch contact.

Installation Space

Ensure that at least the following amount of space is available.

- Space for opening the dust box cover
- Space to enable easy access of the power plug by hand
- ☞ P. 44 "External Dimensions"

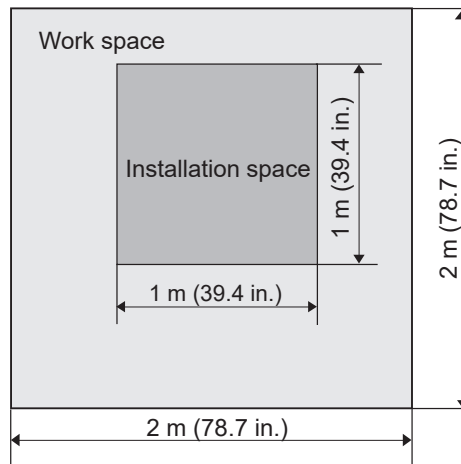

About Height

The installation location should be above the work floor by 0.6 m (23.6 in.) or more. This machine is a desk-top-type unit. Install this machine in a position so that you can easily reach the emergency stop button when operating this machine.

Ensure that a height is available to enable the opening of the front cover.

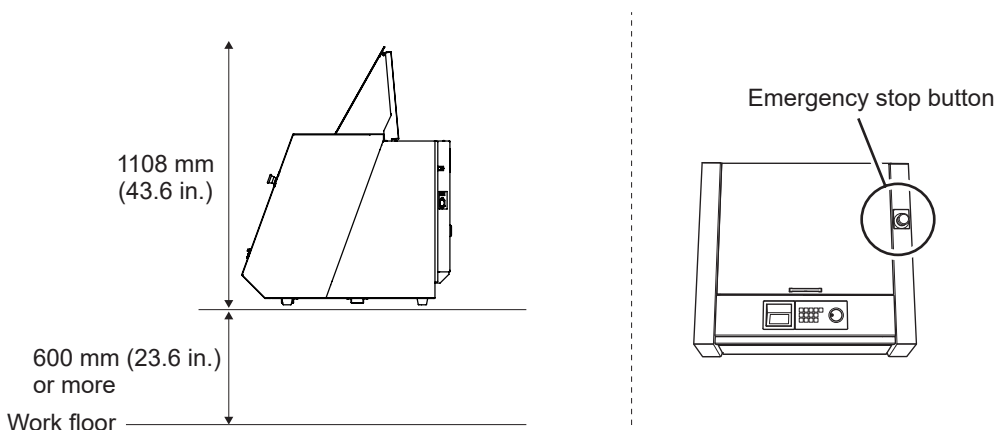

Step 2 : Removing the Retainers

Attach the retainers to protect the machine from vibration during shipment. When installation is complete, remove these and store them in the specified locations.

⚠ WARNING Carry out these operations before you connect the power cord.
The power turning on inadvertently during these operations may result in pinched hands or other injury.

Important

- Remove all the retainers. Any that remain may cause faulty operation or a breakdown when the power is switched on.
- The retainers will be required when moving the machine to a different location. Secure them to this machine for storage so that they do not get misplaced.

Procedure

- 1 Remove the retainers in the locations shown in the following figure using a hexagonal wrench. (2 locations)

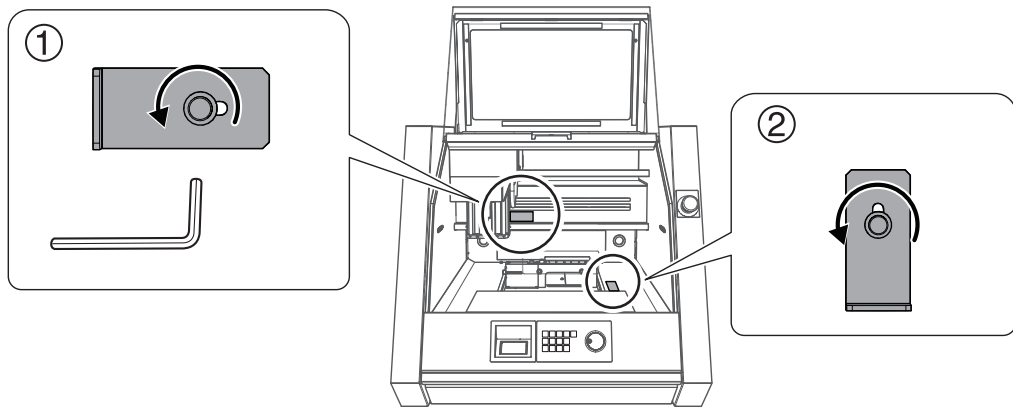

- 2 Secure the removed retainers in place at the location shown in the following figure. Use the screws that you removed in step 1.

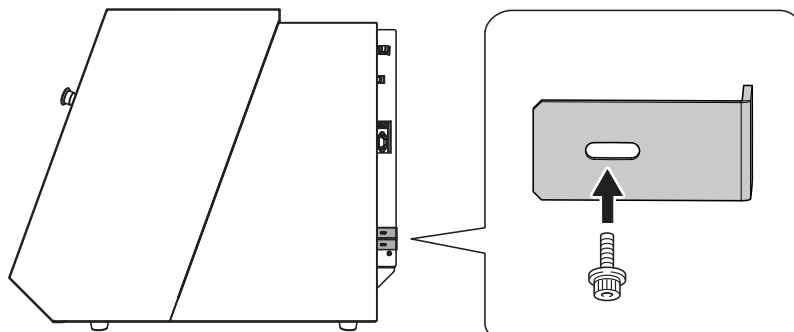

Machine Highlights

Features of This Machine

This is a cutting machine that supports resin raw materials. Installing the exclusive software on your computer and connecting your computer to this machine enables you to perform high-quality cutting. Also, installing the optional rotary axis unit makes it possible to perform four-axis cutting operations such as multiple-surface cutting.

For the latest information on this machine, see the Roland DG Corp. website (<http://www.rolanddg.com>).

Operating the Machine

To operate this machine, use the built-in panel and VPanel. The built-in panel is the operation panel that is installed in this machine. You can use this panel to perform basic functions directly. VPanel is a dedicated application that can be used to operate this machine from a computer screen. For information on how to operate the built-in panel and VPanel, see the "MDX-50 User's Manual (electronic-format manual)."

- ☞ P. 29 "Step 2 : Installing the Roland DG Software Package"
- ☞ P. 32 "Viewing User's Manuals"

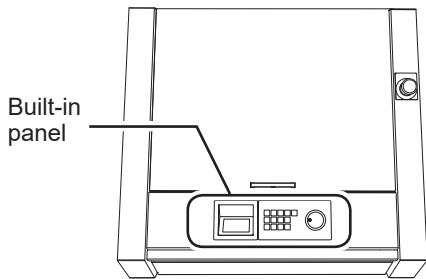



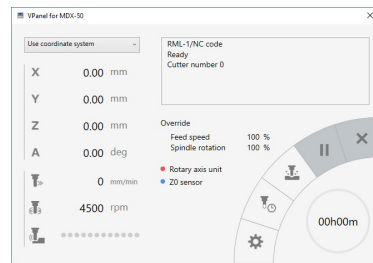

VPanel



Documentation Included with the Machine

This machine's documentation is organized as shown below. In order to use this machine to the extent of its potential, read the appropriate manual according to your purpose.

 <p>Paper manual</p>	<div style="border: 1px solid black; border-radius: 10px; padding: 10px; margin-bottom: 10px;">  <p>Be sure to read this first.</p> <ul style="list-style-type: none"> • MDX-50 Setup Guide (this document) </div>
 <p>Electronic-format manuals</p>	<div style="border: 1px solid black; border-radius: 10px; padding: 10px; margin-bottom: 10px;">  <p>These are stored on the included Roland DG Software Package CD.</p> <p>☞ P. 32 "Viewing User's Manuals"</p> </div> <ul style="list-style-type: none"> • MDX-50 User's Manual • NC Code Reference Manual • Manuals for the software programs included on the Roland DG Software Package CD

Part Names and Functions

Front

Front cover

If you open this cover, cutting automatically stops for your safety.
☞ P. 26 "Emergency Stop or Pause Due to Opening or Closing the Cover"

Built-in panel

☞ User's manual (electronic-format manual)

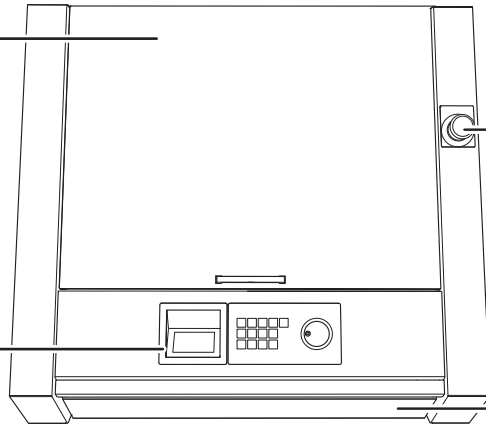

Emergency stop button

Press this in an emergency to turn off the power and stop the machine.
☞ P. 25 "Performing an Emergency Stop on This Machine"

Dust box cover

The dust box is contained within this cover. If you open this cover, cutting automatically stops for your safety.
☞ P. 26 "Emergency Stop or Pause Due to Opening or Closing the Cover"

Inside the Machine

Spindle head

☞ P. 23 "Spindle head"

Status light

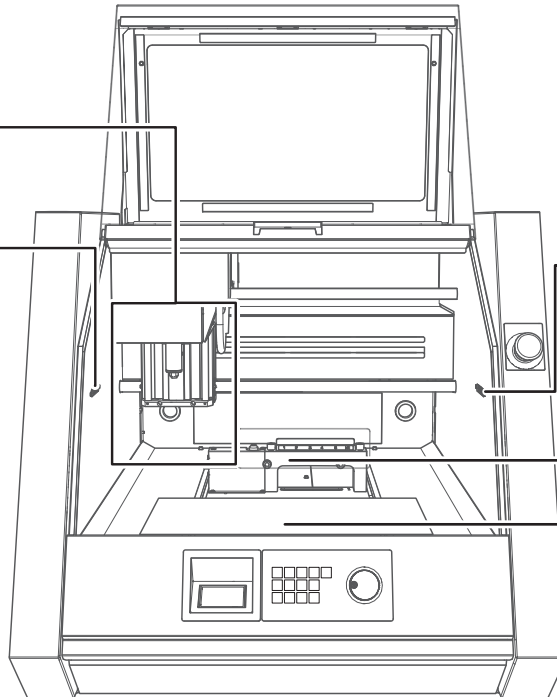

Status light

The color of the lights changes depending on the status of the machine.
☞ User's manual (electronic-format manual)

ATC magazine

☞ P. 23 "ATC magazine"

Table

Set the workpiece to cut on this table.

Spindle head

In this document, the mechanisms around the spindle unit, including the spindle motor, are called the "spindle head."

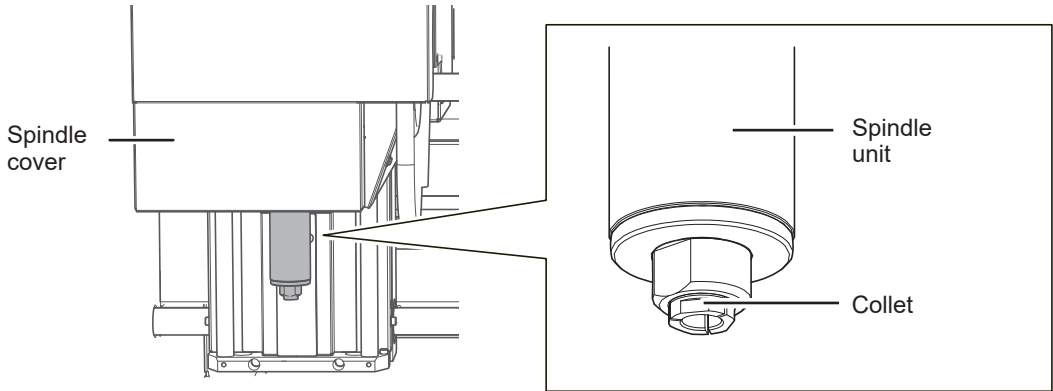

ATC magazine

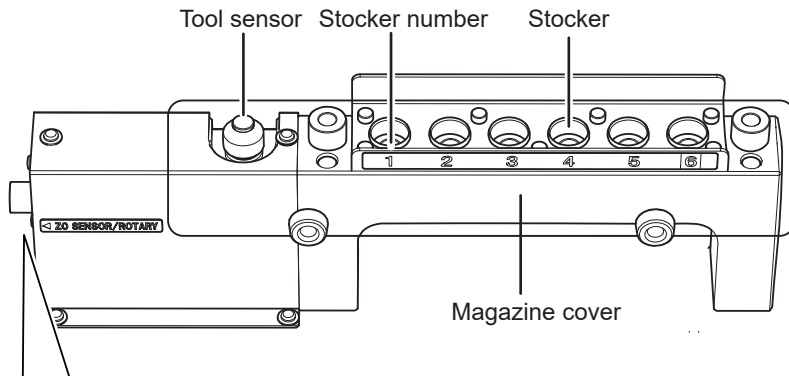

Z0 sensor/rotary axis connector

This is for connecting a Z0 sensor or rotary axis unit (option).

To prevent cutting waste from entering into the connector, attach the protective cap when the connector is not in use.

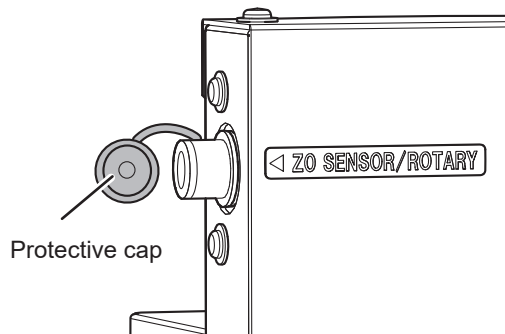

Side

Right Side

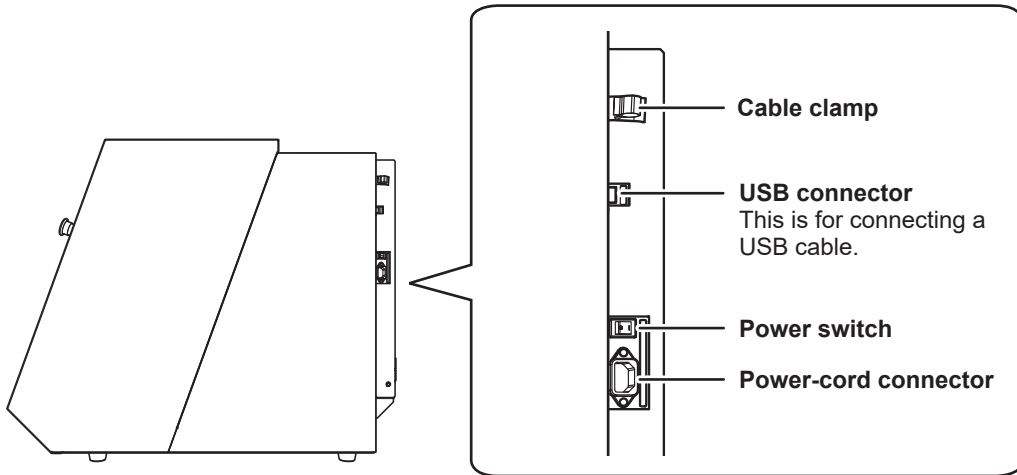

Left Side

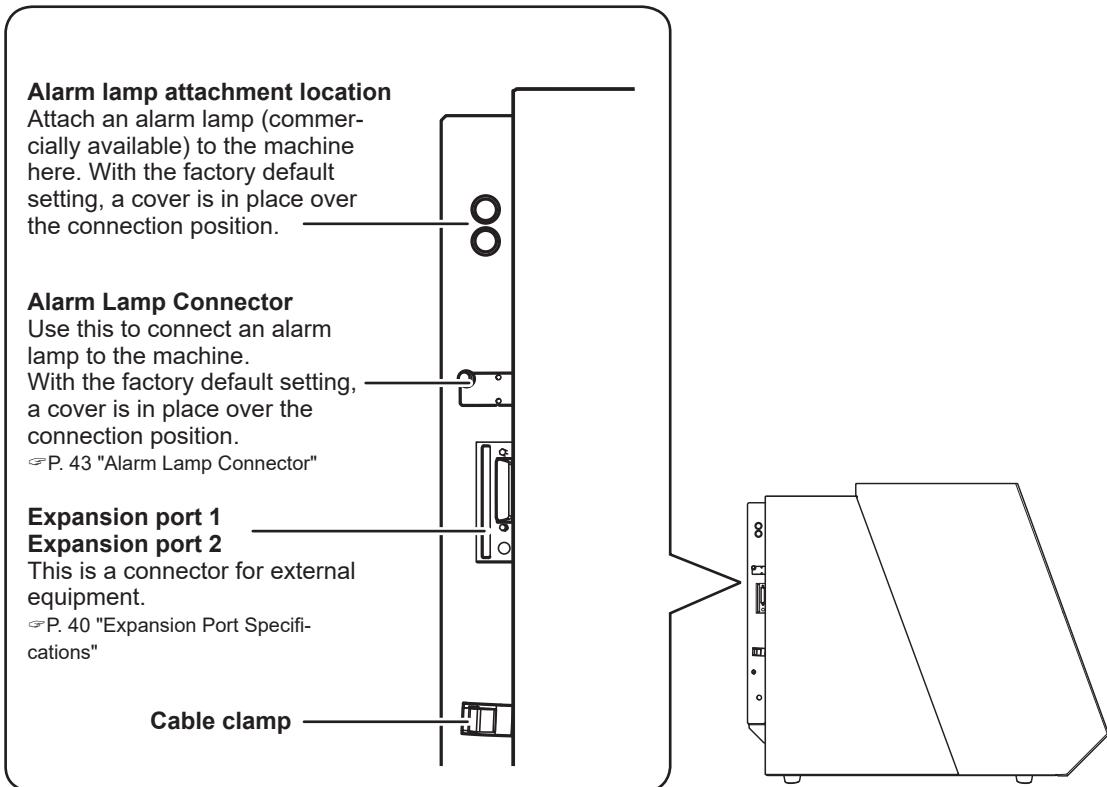

Performing an Emergency Stop on This Machine

Emergency Stop

When you press the emergency stop button, operation stops immediately.

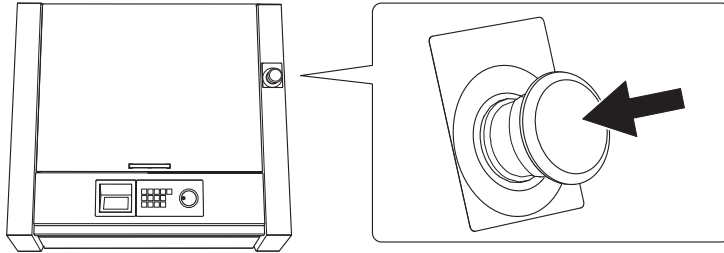

Canceling an Emergency Stop

Procedure

- 1 Switch off the power switch.

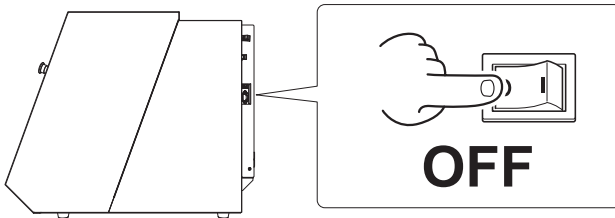

- 2 Turn the button in the direction of the arrows.

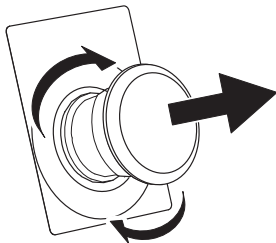

- 3 Switch on the power switch.

Emergency Stop or Pause Due to Opening or Closing the Cover

Emergency Stop Due to Opening or Closing the Cover

To ensure safety, opening the front cover or the dust box cover during cutting or spindle rotation causes this machine to perform an emergency stop. Follow the displayed messages to cancel the emergency stop.

Canceling an Emergency Stop

Procedure

- 1 When you close the cover, a message is displayed on the built-in panel.

Example)

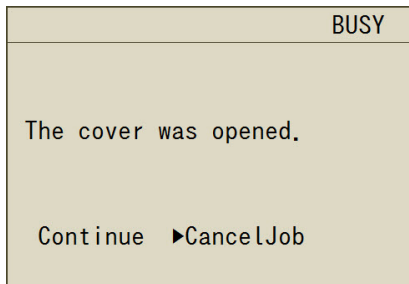

Example)

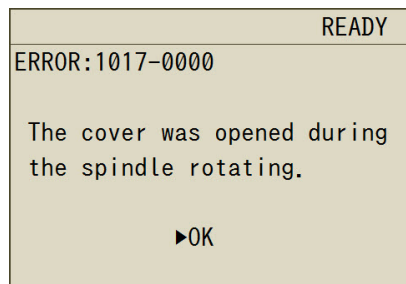

- 2 When a screen is displayed asking you to select either "Continue" or "Cancel job," select and then press [ENTER].

The selection screen may not be displayed. In that situation, press [ENTER].

Important

When an emergency stop occurs due to the cover being opened during cutting, selecting to continue cutting will have an adverse effect on the cutting results.

If you want to open the cover during cutting

If you want to open the cover during cutting, press [PAUSE/CANCEL] to pause the cutting, wait for the operations to stop, and then open the cover. However, when you have disabled the "Tool up in pause" function in VPanel, the spindle will not pause. Before opening the cover, hold down [SPINDLE] on the built-in panel to stop the spindle.

☞ User's manual (electronic-format manual)

Pause Due to Opening or Closing the Cover

To ensure safety, opening the front cover or the dust box cover during standby, when operations are paused, or in other situations when the spindle is not rotating will cause the machine to pause its operations and display a message. When you clear the message using the following procedure, the machine will return to the previous screen.

Canceling a Pause

Procedure

- 1 A message is displayed on the built-in panel.

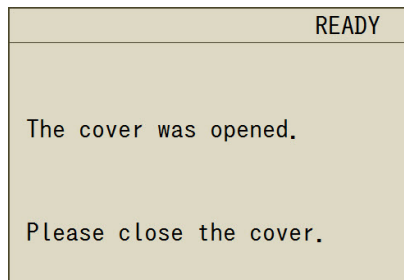





- 2 Close the cover, and then press [ENTER].

The machine returns to the state that it was in prior to the cover being opened. If the machine was performing automatic correction or Z0 sensing, it completes the operation and moves to the view position.

Preparing the Machine for Use

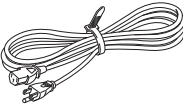
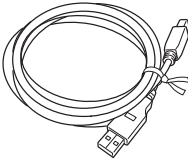
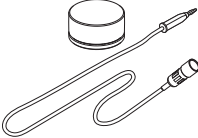
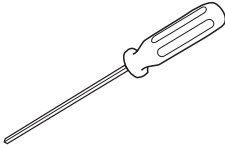
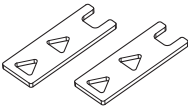
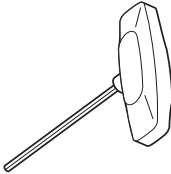
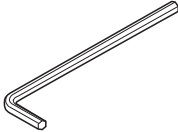
Step 1 : Checking the Included Items

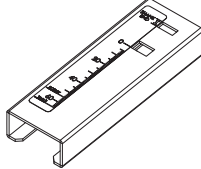
The following items are included with the machine. Make sure they are all present and accounted for.

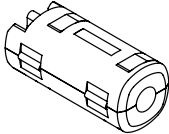
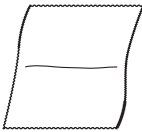
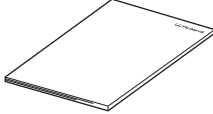
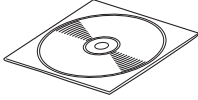
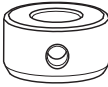
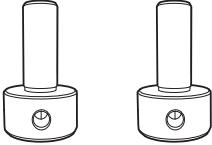
 <p>Power cord (1)</p>	 <p>USB cable (1)</p>	 <p>Z0 sensor (1)</p>	
 <p>Hexagonal screwdriver (1)</p>	 <p>Wrenches (2)</p>	 <p>T-shaped hexagonal screwdriver (1)</p>	
 <p>Hexagonal wrench (1)</p>	 <p>Detection pin (1)</p>	 <p>Tool positioner (1)</p>	 <p>Mounting screws (16)</p>
 <p>Ferrite Core (1)</p>	 <p>Cloth for care (1)</p>	 <p>MDX-50 Setup Guide (1) (this document)</p>	 <p>Roland DG Software Package CD (1)</p>
 <p>Tool holder (6)* (6 mm or 0.25 in.)</p>		 <p>Tool holder (2)* (3 mm ,4mm (1 each) or 0.125 in. (2))</p>	

* For attachable tool, refer to the P. 46 "Specifications".

Step 2 : Installing the Roland DG Software Package

What Is the Roland DG Software Package?

The following pieces of software are included on the Roland DG Software Package CD. "(*)" indicates drivers and software that are required for the operation of this machine.

Windows Driver(*)	This is a Windows-based driver required for sending data from a computer to the machine.	
VPanel for MDX-50 (*)	This is the dedicated software for controlling this machine. This software is used to operate this machine and configure various settings.	
SRP Player	This is a piece of CAM software that imports general-use 3D data - such as IGES, DXF (3D), or STL - and outputs tool paths to the machine.	
ClickMILL	This software is useful for post-processing of existing workpieces such as "pocket-cutting" to cut off the inside of a shape of a graphic, "clipping" to cut out the workpiece to the shape of the specified graphic, and "surface leveling" to flatten the surface of the workpiece.	
MDX-50 Manuals (electronic-format manuals)	MDX-50 User's Manual	This manual explains how to operate the software, how to perform cutting using this machine, and how to perform maintenance.
	NC Code Reference Manual	This manual explains information such as how to program NC codes.

System Requirements for Installation

Operating system (OS)	Windows 10, 8.1, 7 (32- or 64-bit version)*1,*2,*3
CPU	Minimum required CPU for the operating system
Memory	Minimum amount of required RAM for the operating system
Optical drive	CD-ROM drive
Video card and monitor	A display with at least 16-bit color and a resolution of 1024 × 768 or more is recommended (a video card that supports Open GL is recommended).

➤ For the latest information, see the Roland DG Corp. website (<http://www.rolanddg.com>).

(*1) This software is a 32-bit application and therefore runs in WOW64 (Windows-On-Windows 64) when running on 64-bit versions of Windows operating systems.

(*2) Internet Explorer 8.0 or later is required.

(*3) Operations have not been verified in virtual Windows environments such as Hyper-V and Virtual PC.

Installation Procedure

You can install the driver, software, and electronic-format manual all at once. You can also install the driver and each piece of software separately.

☞ User's manual (electronic-format manual) "Installing the Driver Separately"

Important

- Be sure to connect the machine to the computer as instructed in the procedure. Failure to follow the correct procedure may make installation impossible.
- If an old version of SRP Player is installed, uninstall it, and then install a new version.

Procedure

- 1 Before installation, confirm that the machine and the computer are not connected with the USB cable.
- 2 Log on to Windows as the computer's administrator (or as an "Administrators" account).
- 3 Insert the Roland DG Software Package CD into the CD-ROM drive of the computer. When the automatic playback window appears, click [Run menu.exe]. If a "User Account Control" window appears, click [Allow] or [Yes], and then continue with the installation. The setup menu screen appears automatically.
- 4 Click [Install].
Install the MDX-50 driver and the various software programs all at once. Follow the on-screen instructions to proceed with the installation.

☞ P. 29 "Step 2 : Installing the Roland DG Software Package"



If the following screen appears during installation

Windows 10

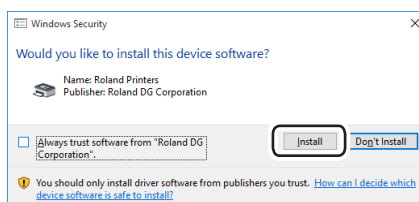

Click [Install].

Windows 8.1

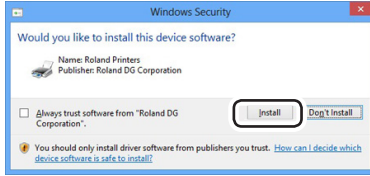

Click [Install].

Windows 7

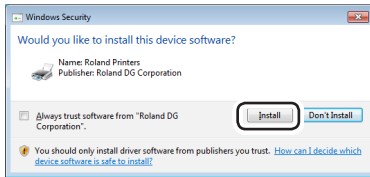

Click [Install].

5 When the window shown in the following figure appears, click [OK].

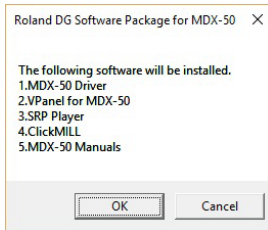

6 Click [Install], select "Roland MDX-50" for the device name and "USB" for the port, and then click [Start].

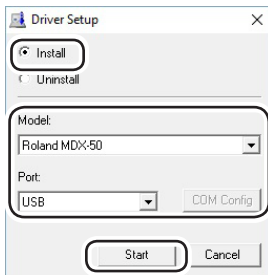

The driver installation begins. Follow the on-screen explanations to proceed with the installation.

MEMO

When the driver installation is complete, the software installation begins. Follow the on-screen explanations to proceed with the installation.

7 When the installation is complete, remove the Roland DG Software Package CD from the computer.

Viewing User's Manuals

The documentation for the machine and for the software programs is in electronic format. Follow the procedure below to view these manuals.

☞ P. 21 "Documentation Included with the Machine"

Windows 10 and 7

From the [Start] menu, click [All apps] (or [All Programs]), [MDX-50 Manuals], and then click [User's Manual].

Windows 8.1

On the [Start] screen, click . On the [Apps] screen, click the [User's Manual] icon under [MDX-50 Manuals].

Step 3 : Connecting the Cable

Connecting the Power Cord

⚠ WARNING Do not use the machine with any electrical power supply that does not meet the ratings displayed on the machine. Doing so may result in fire or electrical shock.

⚠ WARNING Handle the power cord, plug, and power outlet correctly and with care. Never use any article that is damaged. Using a damaged article may result in fire or electrical shock.

⚠ WARNING When using an extension cord or power strip, use one that adequately satisfies the machine's ratings (for voltage, frequency, and current). Use of multiple electrical loads on a single power outlet or use of a lengthy extension cord may cause fire.

⚠ WARNING Connect the machine to ground. This can prevent fire or electrical shock due to electric leakage in the event of a malfunction.

⚠ WARNING Connect this machine to a power outlet (100 V). Never connect this machine directly to a power distribution panel or other such fixed wiring equipment. Doing so increases the risk of fire or electrical shock.

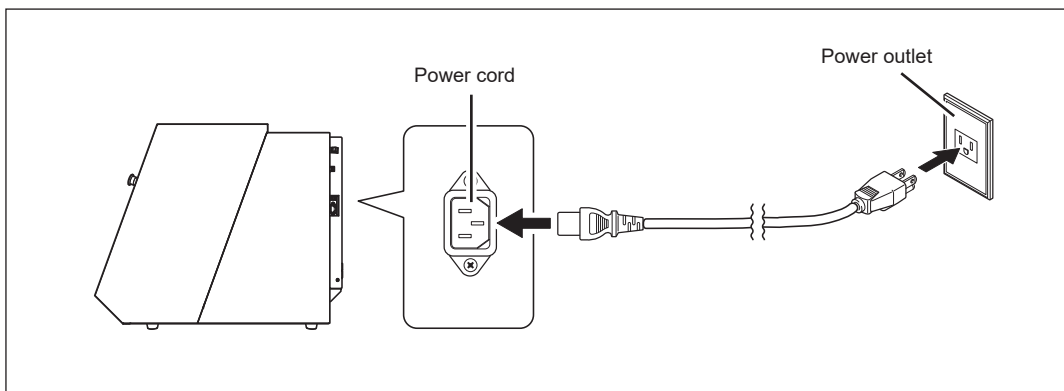

Step 4 : Switching On the Machine's Power Switch (Setting the Panel Display Language)

WARNING

This procedure makes the machine operate.

Before you perform this procedure, check to make sure that operation of the machine will not create any hazard or danger.

Procedure

- 1 Close the front cover and the dust box cover.
- 2 Switch on the power switch.

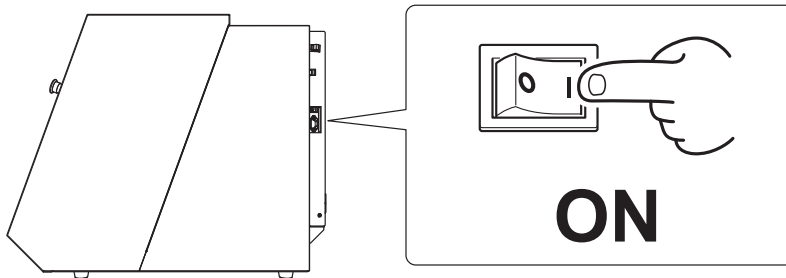

- 3 When the following screen appears, press [MENU] on the built-in panel.
"Please hit [ENTER] key." is displayed on the screen.

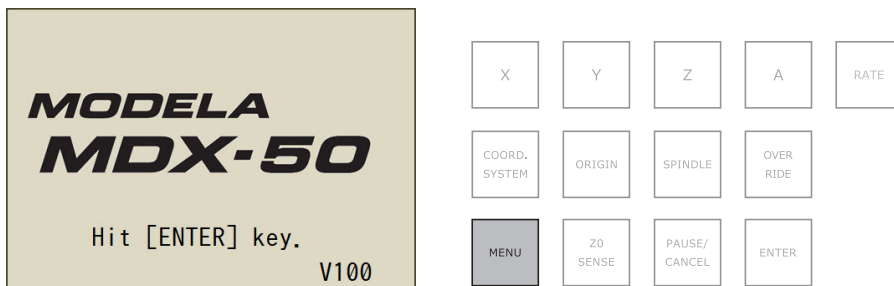

- 4 Use the hand-wheel to select the display language, and then press [ENTER].

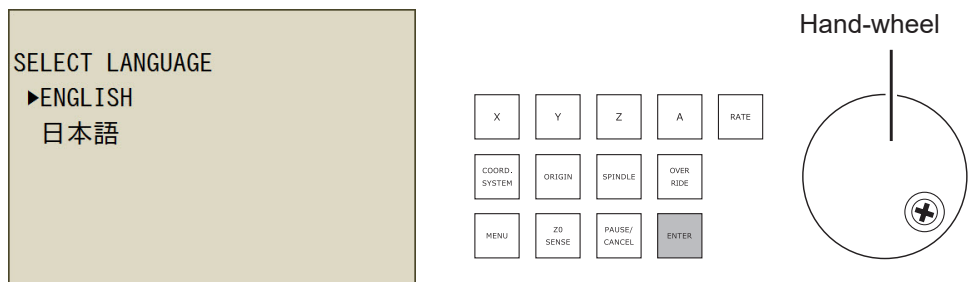

- 5 When "Please hit [ENTER] key." is displayed on the screen, press [ENTER].
The initial operation starts.

Step 5 : Connecting the Machine to a Computer Using a USB Cable

Important

- For the USB cable, use the included cable.
- Do not use a USB hub. Connection may not be possible.

Procedure

- 1 **Connect the machine to the computer using the USB cable.**
The driver will be installed automatically.

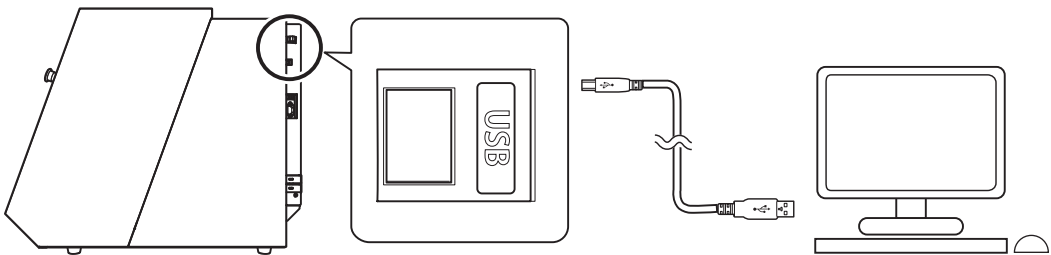

- 2 **Secure the USB cable with a cable clamp.**

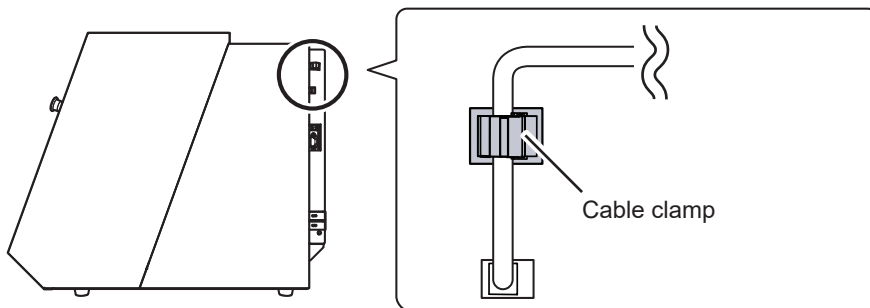

Step 6 : Starting VPanel

Procedure

- 1 Close the front cover and the dust box cover.
- 2 Display VPanel.

Windows 10 and 7

From the [Start] menu, click [All apps] (or [All Programs]), [VPanel for MDX-50], and then click [VPanel for MDX-50].

Windows 8.1



On the [Start] screen, click . On the [Apps] screen, click the [VPanel for MDX-50] icon under [VPanel for MDX-50].

The top window of VPanel will appear.

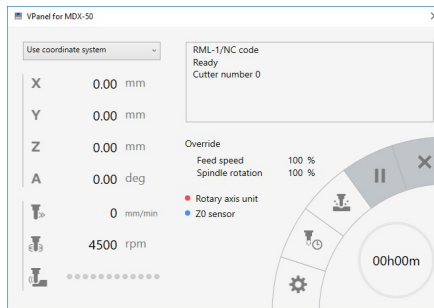
☞ User's manual (electronic-format manual) "VPanel Doesn't Start Correctly"



It is useful to set VPanel as resident software.

VPanel is a piece of resident software that is constantly working to manage the cutting machine and send e-mails.* It is useful to configure VPanel so that it starts automatically when the computer starts. Clicking the Close button () in the upper right of the top window will minimize the window to the task tray. The window will disappear from the screen, but the program will not be exited. While VPanel is running,  is constantly displayed in the task tray.

* E-mails are sent to notify the user of cutting completion or errors that occur.

For the setting method and other details, see the user's manual (electronic-format manual).

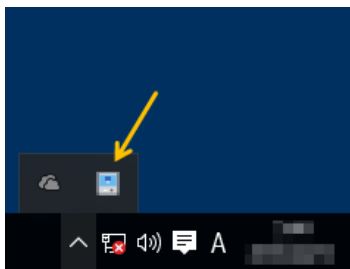

Step 7 : Performing Spindle Run-in

Perform spindle run-in to stabilize the rotation of the spindle.

Procedure

- 1 Click  in the VPanel top window, the [Maintenance] tab, and then click [Spindle...]. The VPanel "Spindle maintenance" dialog box appears.

- 2 Click [Start] next to "Run-in."

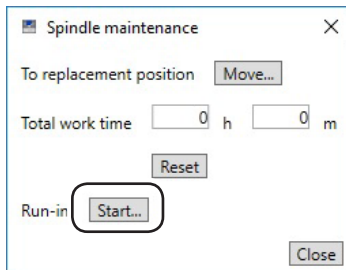

- 3 When the window shown in the following figure appears, click [OK].

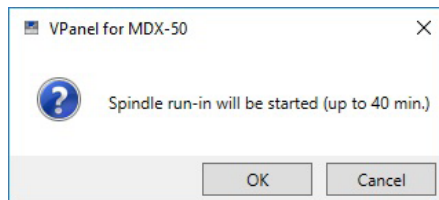

Run-in will begin. (It takes approximately 40 minutes.)

- 4 When the window shown in the following figure appears, click [OK].

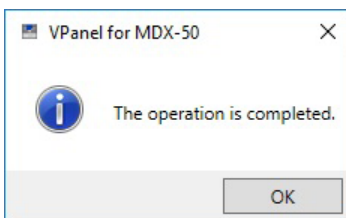

Step 8 : Correcting the Machine (Automatic Correction)

Performing automatic correction will correct the ATC magazine and rotary axis positions.

Required Items

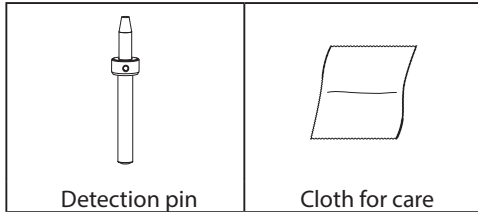

1. Install the detection pin.

- 1 Use the included cloth for care to wipe clean the detection pin and the protrusions on the left and right of the ATC magazine.

If any dirt is present in these locations, it may not be possible to perform the correction properly.

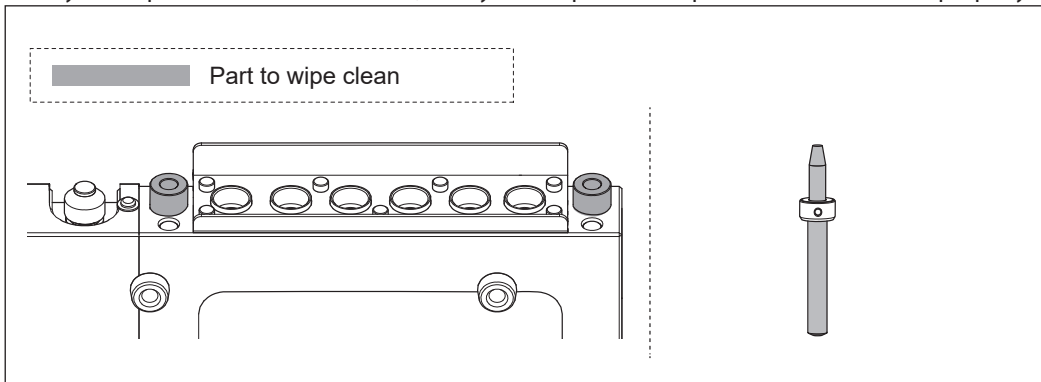

- 2 Load the detection pin in the ATC magazine's number 6 position.

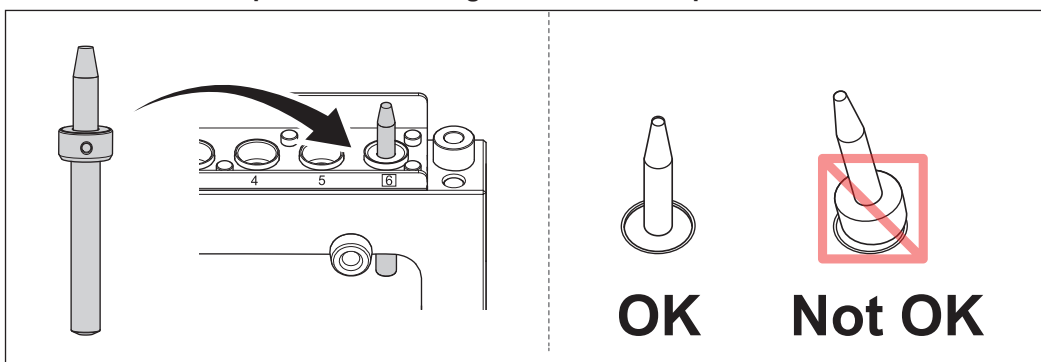

- 3 Close the front cover.

- 4 Press [ENTER].

2. Perform automatic correction.

- 1 Click  in the VPanel top menu, the [Correction] tab, and then click [Automatic correction].

The VPanel "Automatic correction" dialog box appears.

- 2 Select the [Magazine] check box, and then click [Start Correction].

You can use the [Rotary axis unit] check box when you are using the optional rotary axis unit.

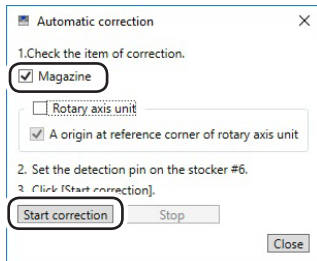

Automatic correction starts.

- 3 When the window shown in the following figure appears, click [OK].

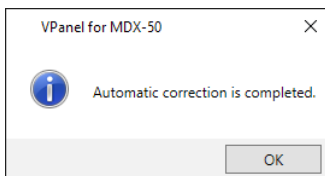

- 4 Once automatic correction is complete, remove the detection pin.

Step 9 : Exiting VPanel

Procedure

- 1 Right-click  in the task tray, and then click [Exit].

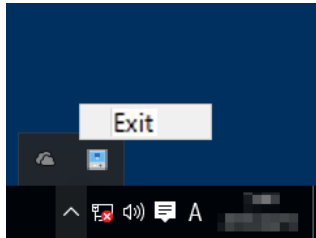

MEMO

Even if you click the Close button ([x]) to close the top window, you will not exit VPanel.

Step 10 : Switching Off the Machine's Power

Procedure

- 1 Switch off the power switch.

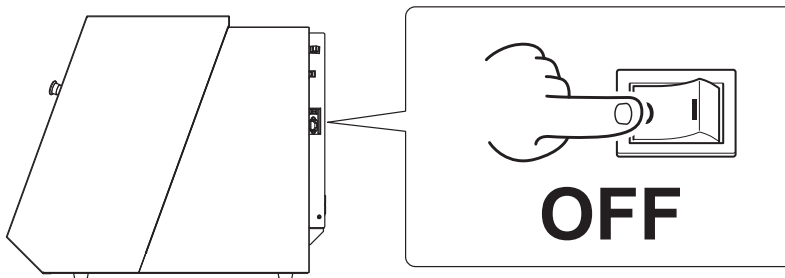

Machine Specifications

Power Rating and Serial Number Location

Serial number

The serial number is required for maintenance, servicing, and support. Never peel off the label.

Power rating

Use a power supply that meets the requirements for voltage, frequency, and amperage given here.

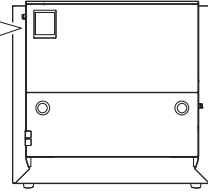

Expansion Port Specifications

Important

Be sure to turn off the power of machine when the cable connect (or remove) to the machine. Connecting (or removing) the cable to the cutting machine while the cutting machine is on may cause malfunctions.

* We are not responsible for devices connected to this port.

Expansion port 1

PIN number	Signal	Overview/function
①	24V	Set the output up to 100 mA.
②	SPINDLE_ON	This signal activates during spindle rotation.
③	N.C.	

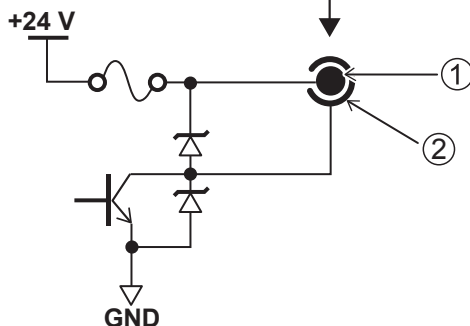
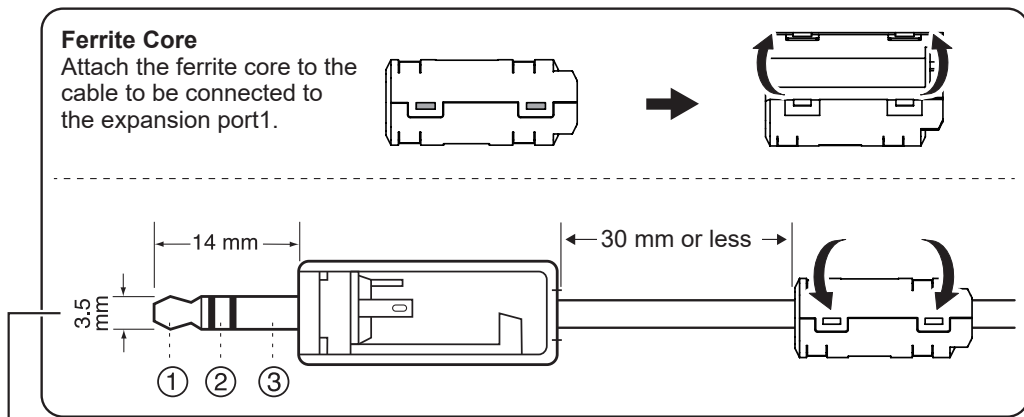

Note

Do not use terminal ③.
Use only terminals ① and ②.

Note

- Be sure to use the expansion port within the rated range shown above.
- Do not apply additional voltage to the terminal.
- Do not short-circuit the terminal to ground.

Expansion Port 2

PIN number	Signal	IN/OUT	Overview/function
1	GND		Connect this to the power supply GND.
2	Reserve RXD	IN	This is a spare output for communication.
3	Reserve RXD	OUT	This is a spare output for communication.
4	N.C.		
5	Reserve Out1	OUT	This is a spare general-purpose output.
6	Reserve Out2	OUT	This is a spare general-purpose output.
7	Reserve Input1	IN	This is a spare general-purpose output.
8	GND		Connect this to the power supply GND.
9	ERROR	OUT	This signal activates when a fatal error occurs.
10	PAUSE	OUT	This signal activates when cutting is paused.
11	N.C.		
12	Reserve 5V		This is a spare 5 V power supply input for communication.
13	24V_EXT		Connect this to the 24 V power supply. Prepare a power supply that can supply 100 mA or more.
14	N.C.		
15	N.C.		
16	GND		Connect this to the power supply GND.
17	N.C.		
18	EMG_STOP	IN	Stop the machine.
19	SP_START	OUT	This signal activates during spindle rotation.
20	GND		Connect this to the power supply GND.
21	GND		Connect this to the power supply GND.
22	READY	OUT	This signal activates when cutting is possible.
23	BUSY	OUT	This signal activates when the machine is operating.
24	N.C.		
25	24V_EXT		Connect this to the 24 V power supply. Prepare a power supply that can supply 100 mA or more.

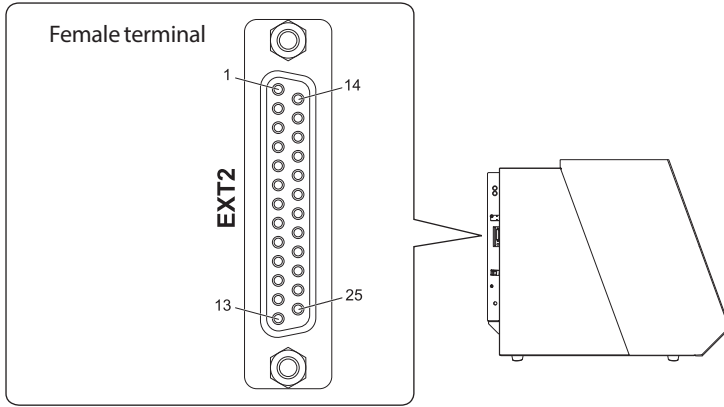

Output specifications

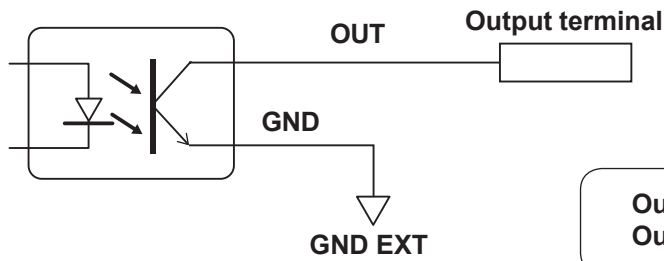

Output: Open collector
Output capacity: 10 mA max.

Input specifications

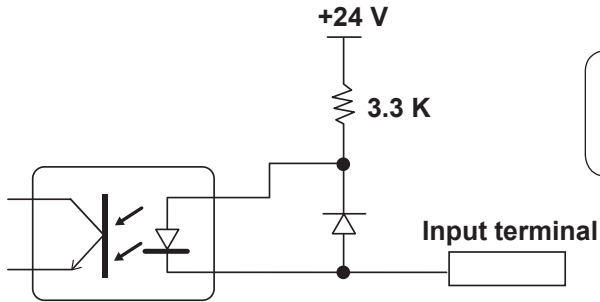

Power supply voltage: 24 V ± 10%
Input current: 10 mA or less

Alarm Lamp Connector

PIN number	Signal	Overview/function
① (left)	24V	Set the output up to 150 mA.
②	ERROR	This signal activates when a fatal error occurs.
③	BUSY	This signal activates when the machine is operating.
④ (right)	READY	This signal activates when preparations are complete.

Connector layout

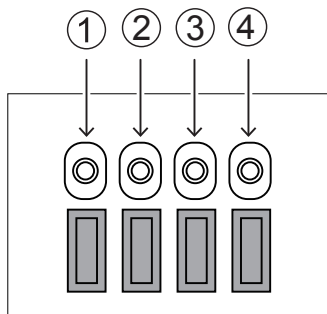

Output specifications

Use ① 24V as the power supply, and then connect the lamp to ②, ③, and ④.

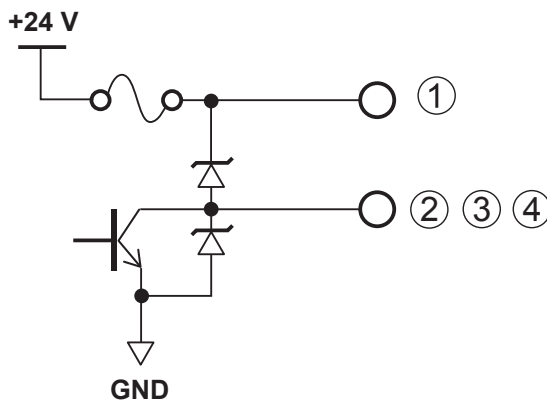

Power supply: +24 V (150 mA)
Output: Open collector
Output capacity: 50 mA max.

Dimensional Drawings

Unit: mm (inch)

External Dimensions

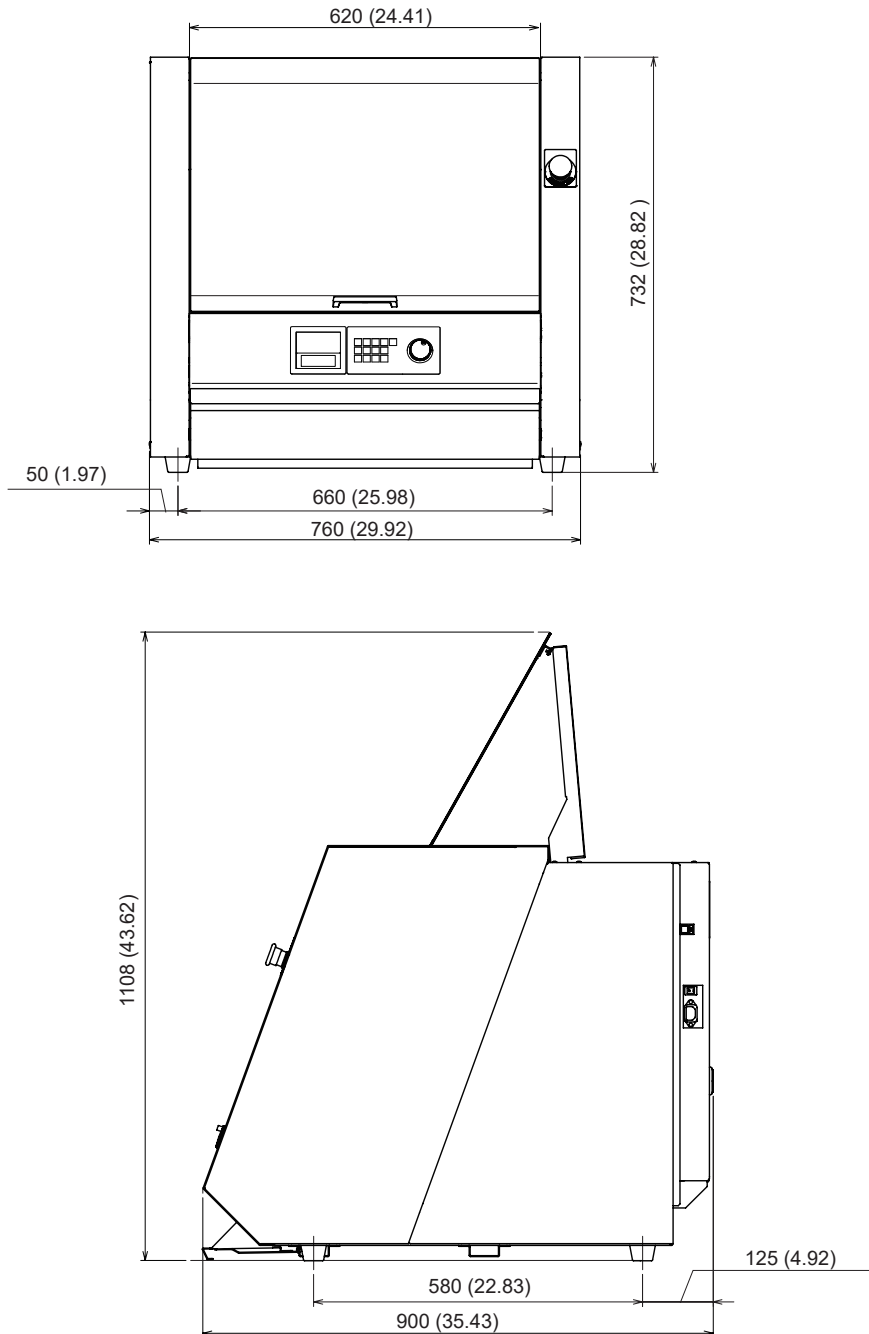

* A space of 700 mm (27.56 inch) in front of the product is required when pulling out the dust box cover.

Table

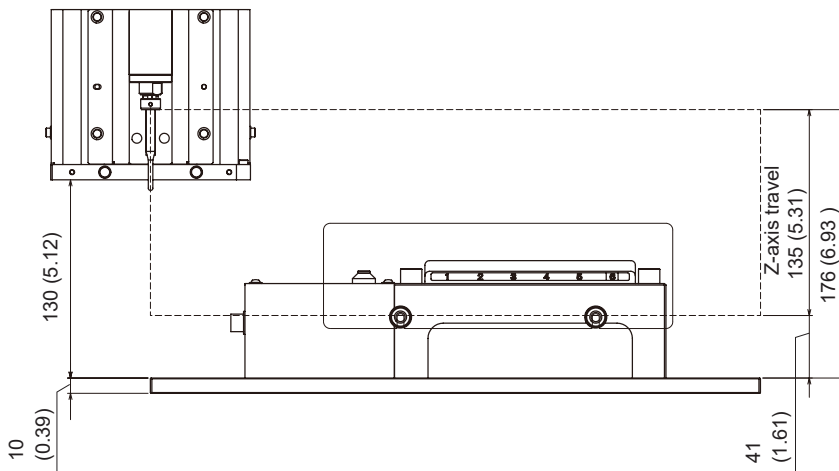
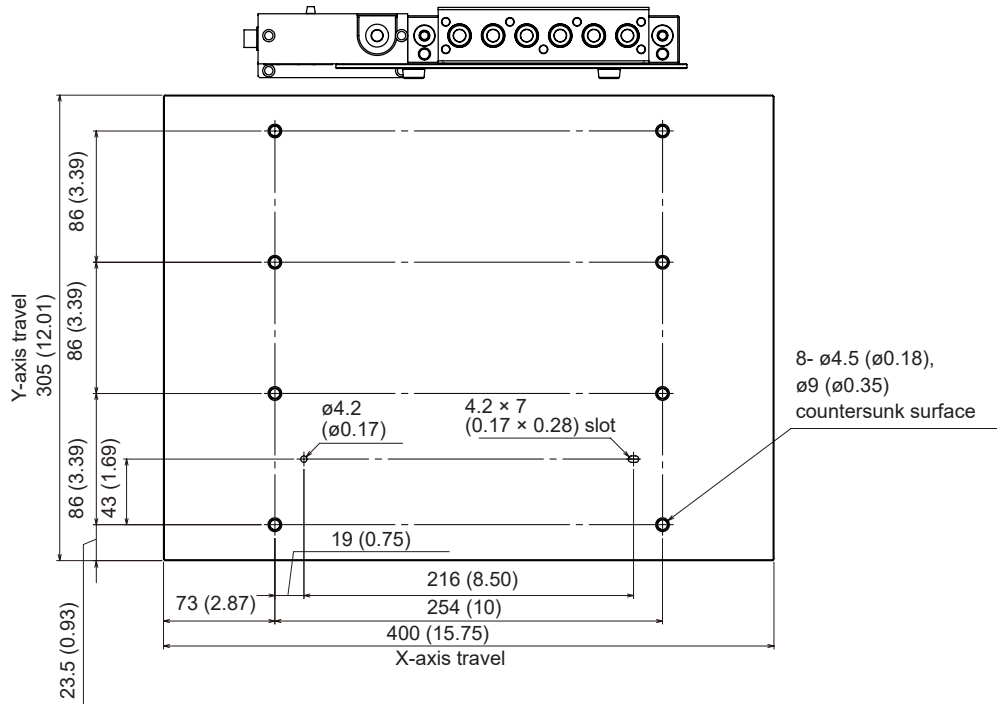

Detection pin

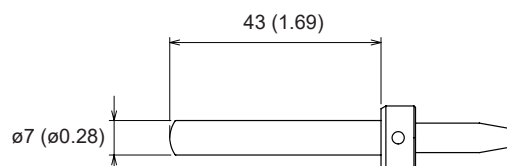

Specifications

	MDX-50	
Cutable material	Resins such as chemical wood and modeling wax (metal not supported)	
Operating range	X, Y, Z: 400 × 305 × 135 mm (15.8 × 12.0 × 5.3 in.)	
Loadable workpiece size	X, Y, Z: 400 × 305 × 100 mm (15.8 × 12.0 × 3.9 in.)	
Axis drive system	Stepping motor	
Operating speed	X, Y: 7 to 3600 mm/min (0.3 to 141.7 in./min) Z: 7 to 3000 mm/min (0.3 to 118.1 in./min)	
Software resolution	0.001 mm/step (0.039 mil/step; RML-1) 0.001 mm/step (0.039 mil/step; NC code)	
Mechanical resolution	0.01 mm/step (0.39 mil/step; half step)	
Spindle motor	Brushless DC motor	
Spindle rotation	4500 to 15000 rpm	
Number of tools housed	6 (However, one tool is also used as the detection pin.)	
Attachable tool	mm specifications	Shank diameter: 6 mm, tip diameter: 6 mm or less, length: 30 to 90 mm * Tools with shank diameters of 3 mm or 4 mm can be used by installing them in the included tool holder.
	inch specifications	Shank diameter: 0.25 in. tip diameter: 0.25 in. or less, length: 30 to 90 mm (1.18 to 3.54 in.) * Tools with shank diameters of 0.125 in. can be used by installing them in the included tool holder.
Interface	USB	
Control command sets	RML-1, NC code	
Power requirements	AC 100 to 240 V ±10%, 50/60 Hz (overvoltage category: II, IEC 60664-1) 1.2 A	
Power consumption	Approx. 95 W	
Operating noise	During operation: 60 dB (A) or less (when not cutting) During standby: 45 dB (A) or less	
External dimensions	Width × depth × height: 760 × 900 × 732 mm (29.92 × 35.43 × 28.82 in.)	
Weight	122 kg (269 lb.)	
Installation environment	Indoor use at altitudes up to 2000 m Temperature: 5 to 40°C (41 to 104°F) Humidity: 35 to 80%RH (no condensation) Ambient pollution degree: 2 (as specified by IEC 60664-1) Short-term temporary overvoltage: 1440 V Long-term temporary overvoltage: 490 V	
Included items	Power cord, USB cable, manual, Roland DG Software Package CD, detection pin, hexagonal screwdriver, hexagonal wrench, wrench, tool holder, tool positioner, Z0 sensor, etc.	

System Requirements for USB Connection

Computer	A model preinstalled with Windows 10, 8.1, or 7 (32 or 64 bit) or an upgraded computer originally preinstalled with Windows 7 or later
USB cable	Use the included USB cable.

 Roland

 Roland