

# INSTA™

INSTA GRAPHIC SYSTEMS



## MODEL 907

OPERATION AND MAINTENANCE MANUAL

## Safety Summary



### WARNING

In case of power cord damage, do not attempt to repair or replace the power cord. Contact the manufacturer or the local distributor.



### WARNING

For protection against fire and electric shock, replace with same type and rating fuse. Fuse rated max. 1 amp 120V.



### WARNING

Hot Surface. Avoid contact.



### CAUTION

During normal operation, the base of the machine needs to be installed or placed above the wall socket.



### CAUTION

The recommended input pressure shall not exceed 100 psi. The operating pressure is from 30-100psi.



### CAUTION

The operation may be terminated by pressing the **DISENGAGE** switch.



### CAUTION

The machine is to be operated by one person only.



### CAUTION

To reduce the risk of electric shock and injury to persons, disconnect from power supply before servicing and /or cleaning.

## International Symbols



Power Off



Power On



Hot Surface



Risk of Electrical Shock



Protective Earth Terminal



Ground



Wet Conditions



Start Action



Caution - Warning



Disengage

## **Congratulations!**

Your selection of the Insta heat seal machine is a sound business decision. Insta equipment is the result of the highest quality engineering and time-tested design. Your new machine combined with Insta's reputation of innovation in the heat-sealing field, ensures the continuing capability of delivering the best decorated substrates possible.

This manual describes installation, operation, and maintenance procedures for your 907 series machine, as well as easy to use instructions for on-the-spot maintenance.

Your machine will have a long trouble-free life. Read this manual and keep it with your machine. It's your key to proper operation and lasting service.

## **General Description**

The 907 is a dual station shuttle press for high speed label application. This pneumatic heat press machine is air-operated to prevent operator fatigue and is equipped with 2 independent lower platens, with an upper heated platen that swings between the two, for optimal efficiency

The 907 has been strategically designed to generate & evenly distribute tremendous pressure throughout the entire platen. And, its cast-in tubular heating element heats the metal from within, to produce consistent and long lasting heat. A successful heat transfer application requires 3 key elements to work in tandem— time, temperature & pressure. The 907 has mastered those elements and gets the job done every time.

Our heat press machines serve as a method of product identification and provide customers with a means of branding their textile-based products through the application of tagless labels, logos, decorative front and back graphics and over-sized prints.

## **Limited Machine Warranty**

Please refer to Heat Press Limited Warranty on pages 15-16.

## Installation



**DOMESTIC – 907**  
Use a **separate** 15 amp AC circuit. Only industrial extension cords with proper wire size should be used: size 18/3 wire for distances up to 25 feet, and size 16/3 for distances up to 50 feet.



**INTERNATIONAL – 907**  
Use a **designated** 16-amp AC circuit. Only industrial extension cords with proper wire size (2.5 sq. mm) shall be used.



**IMPORTANT**  
The appliance must be plugged into a proper receptacle of the proper size and rating. Equally important the line voltage must be able to accommodate this appliance as well as *other appliances operating on this circuit.*

## Specifications

Voltage Model 907	<b>120 Volts AC</b> 1000 Watts	50/60 Hertz 8.3 Amps
Voltage Model 907	<b>230 Volts AC</b> 920 Watts	50/60 Hertz 4.0 Amps
Model 907 Machine Weight	61 Pounds (27.7 KG)	

## Degree of Protection

IP (Ingress Protection) rating according to IEC 60529.

**NOTE**  
*IEC 60529 does not specify sealing effectiveness against the following: mechanical damage of the equipment; the risk of explosion; certain types of liquid conditions, e.g. those that are produced by condensation; corrosive vapours; fungus; vermin*

**IP54 = IP**  
1<sup>st</sup> Digit 5  
2<sup>nd</sup> Digit 4

1 <sup>st</sup> Digit	Protection from solid objects	2 <sup>nd</sup> Digit	Protection from moisture
0	Non protected	0	Non protected
1	Objects greater than 50mm	1	Dripping water
2	Objects greater than 12mm	2	Dripping water when tilted up to 15 deg.
3	Objects greater than 2.5mm	3	Spraying water
4	Objects greater than 1mm	4	Splashing water
5	Dust protected	5	Water jets
6	Dust tight	6	Heavy seas
--	---	7	.15m – 1m immersion
--	---	8	1m + submersion

## Operation

1. Push **ON/OFF** switch to **ON** position.
  2. Set desired temperature (See Controller Operation).
  3. Allow the machine to warm up until the selected temperature is reached.
  4. Set the desired pressure by adjusting the air pressure regulator.
  5. Select the desired timing cycle (See Controller Operation).
  6. Place the substrate on lower platen, smoothing out all wrinkles.
  7. Position transfer or lettering on substrate.
  8. Swing the upper arm into position directly over the lower platen.
  9. Depress and hold both start buttons simultaneously until the lower platen contacts the upper platen. The **start buttons must be held until the upper and lower platens make contact**. At this point the machine operation is fully automatic. The platens seal the transfer to the substrate and then release automatically at the end of the selected timing cycle.
- Note:** **Safety Delay** is by default set to **ON**.
- Safety Delay** may be disabled by following instructions on page 10.
10. Swing away the upper platen to the opposite side and remove substrate.



### NOTE

*Another substrate may be prepared on the unused platen during the sealing operation of the used platen.*

11. The **DISENGAGE** button may be pushed at anytime to deactivate the machine.

## Solid State Controller

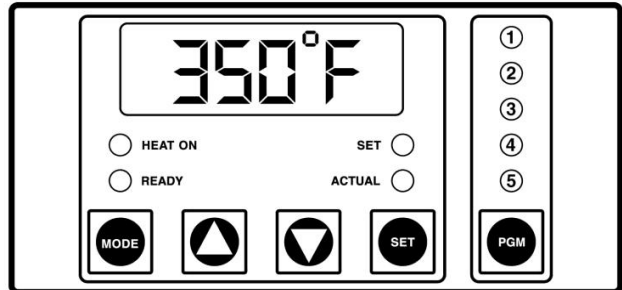

This controller has four (4) control features:

1. Temperature - Temperature may be set from 125 - 450°F (52-232°C).
2. Time - Time may be set from 1 second to 10 minutes.
3. Counter – Cycle counter counts the number of applications from 1 to 9999 (see additional Notes – Counter).
4. Presets - Five (5) presets that can be programmed by the user. Each preset will retain a temperature and time setting, i.e. Program #1 could be set for 325°F and 10 seconds while Program #2 could be set for 375°F and 15 seconds. Once the five presets have been programmed, the user need only press the **PGM** button several times until the desired program is selected. The lit LED above the PGM button indicates the selected program. *Note: there is also a sixth setting that is indicated by no lit LED's.*

## Controller Operation

1. Select the desired preset program by pressing the **PGM** button until the LED above the **PGM** button indicates the desired setting.
2. If a setting other than the programmed presets are desired, press the **PGM** button until **none** of the LED's above the **PGM** button are lit.
3. Changing the Temperature
  - Press the **MODE** button until temperature is displayed.
  - Press and hold **SET** button in while pressing the UP (↑) or DOWN (↓) arrow buttons to the desired temperature setting.
4. Changing the Time
  - Press the **MODE** button until timer is displayed.
  - Press and hold **SET** button in while pressing the UP (↑) or DOWN (↓) arrow buttons to the desired timer setting.



### NOTE

*When the machine is operating with none of the LED's lit, i.e. no presets, the time and temperature will be saved even if the power is turned off. The presets will also be saved when the power is turned off.*



### NOTE

*For operator safety the machine is designed not to operate unless the upper arm is directly over one of the lower platens.*



### NOTE

*The DISENGAGE switch (located in the center of the instrument panel) may be pushed at any time to deactivate the machine.*

## Setting the Presets

1. Push **PGM** and then **MODE** and hold both buttons for 3-5 seconds until the #1 LED starts to blink. This is the **programming mode**.
2. A blinking LED above the **PGM** button indicates which preset is active.
3. Select a program (1,2,3,4,or 5) by pressing the **PGM** button.
4. Setting Temperature
  - Press the **MODE** button until temperature is displayed.
  - Press and hold **SET** button in while pressing the UP (↑) or DOWN (↓) arrow buttons to the desired temperature setting.
5. Setting Time
  - Press the **MODE** button until time is displayed.
  - Press and hold **SET** button in while pressing the UP (↑) or DOWN (↓) arrow buttons to the desired timer setting.
6. Repeat steps 3-5 until all five (5) presets have the desired preset (temperature/time cycle).



### NOTE

If a Fahrenheit/Celsius change is desired, see **Additional Notes – Temperature**.

7. Push **PGM** and then **MODE** and hold both buttons for 3-5 seconds until a single beep is heard to exit the **programming mode**.

**NOTE**

When in the **normal mode**, none of the five program LED's will be **blinking** and the user cannot change the time and temperature for any of the five presets.

**NOTE**

When the machine is operating with **none** of the five program LED's lit, i.e. no presets, the time and temperature **WILL BE SAVED** even if the power is turned off. The presets will also be saved when the power is turned off.

## Additional Notes

### Timer

- The controller has a count down timer, which automatically disengages (opens) the machine at the completion of the application.
- Timer display is minutes:seconds. Range is **00:00** to **10:00**, Colons (:) flash while timer is running.

**NOTE**

The **DISENGAGE** switch (located in the center of the instrument panel) may be pushed at any time to deactivate the machine. The cycle will stop immediately, and the timer will reset.

### Counter

The controller has a built in cycle counter.

- Press **MODE** button until the counter is displayed.
- Counter display range is 0000 to 9999.
- To reset the cycle counter, display the counter reading, then push and hold UP (↑) and DOWN (↓) arrow buttons for 3 seconds until the counter resets to zero (**0000**) on the display.

## Preventive Maintenance Suggestions

The Insta heat seal machines are relatively maintenance free. For long, trouble-free life, the following preventive maintenance should be followed:

1. Do not heat seal items such as buttons, pins, snaps, or zippers that tend to cut the silicone rubber pad or scratch the Teflon heat platen.
2. Periodically clean the Teflon-coated heat platen with a non-abrasive piece of cloth. Stubborn stains may be cleaned, **when platen is cool**, with mineral spirits.
3. When the heat platen is hot and not in use, keep in open position (away from the silicone rubber pad).
4. To prevent soiling of substrate, periodic wiping of the entire exterior machine, including platens, with a clean rag is recommended. If necessary, use mineral spirits for cleaning a **cold** machine. Since mineral spirits are flammable, use precautions and keep away from sparks, flame, or hot heat platen.
5. Turn off air pressure when machine is not being used.
6. Once a month check the air regulator for moisture and drain if needed. To drain the water, first place a container under the regulator bowl and unscrew the knob as indicated in the picture below. Make sure to have the container in place before opening the drain. Ensure water does not get onto electrical wires/connectors.



## General Maintenance

It is recommended that you have the following items available:

- A.Regular screw driver
- B.Phillips head screw driver
- C.Small adjustable wrench
- D.Needle nose pliers with insulated handle
- E.Set of Allen wrenches

With the above items you should be able to accomplish most repairs.

### WARNING

*Power cord replacement should be from the manufacturer only (because it requires a specially prepared cord).*



## Replacement of Parts

Refer to the 3D explosive view and the bill of materials at the end of this manual.

## Micro Switch Adjustment

1. Disconnect power supply; remove the top panel of the instrument housing.
2. Swing upper platen into working position until stop is reached.
3. The micro switch must be adjusted to **JUST CLOSE**, as upper platen swings to this position.
4. To change micro switch setting, loosen the screw on slotted end of micro switch. Move in desired direction to bring switch to **JUST CLOSED** condition (listen for an audible click from micro switch) and re tighten screw.

### NOTE

*Machines are shipped with a standard air fitting. **EUROPEAN models include a MPPF086 quick disconnect air fitting.***



## Airborne Noise Emission

Sound pressure level at operator station does not exceed 70 dB(A).



## Sleep Time, Set Back Temperature, Automatic Shut Off, Temperature Conversion, and User Offset

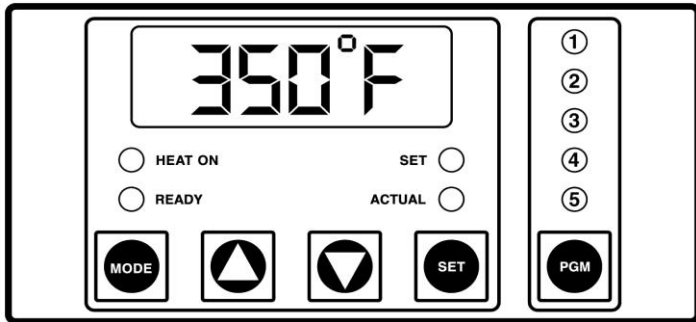

Model 907

The Sleep Mode / Automatic Shut Off is designed to save electrical consumption when the user is not engaged in the usage of machines for a pre-determined period of time defined by the user.

During activation, any disturbances such as the key press or heat press cycle will reset the machine and reset the timers for both Sleep Mode and Automatic Shut Off.

When the Automatic Shut Off is set to OFF and the Sleep Mode is activated, any disturbances to the machine will disengage the Sleep Mode.

When the Sleep Mode is set to OFF, the timer for Automatic Shut Off will activate and resets after every key press or heat press cycle.

- Sleep Time  
(Level 1 – Menu 1)
- Set Back Temperature  
(Level 1 – Menu 2)
- Automatic Shut Off Time  
(Level 1 – Menu 3)
- Temperature Conversion  
(Level 1 – Menu 4)
- User Offset  
(Level 1 – Menu 5)

## Sleep Time

1. Display the **COUNTER** . Enter the Factory Mode by pressing and holding together **SET** then **MODE** for **3 to 5 seconds**.



2. Press and hold together **SET** then **UP** or **DOWN Arrow** to set Sleep Mode Time.



1.\_XX ; XX = Minutes from OFF to 99

## Set Back Temperature

3. Press **MODE**.
4. Press and hold together **SET + UP** or **DOWN Arrow** to set Set Back Temperature.



2.\_XXX ; XXX = Temp. from 225F to 300F

## Automatic Shut Off

5. Press **MODE**.
6. Press and hold together **SET + UP or DOWN Arrow** to set Auto Shut Off Time.



3.\_XX ; XX = Minutes from OFF to 99

## Temperature Conversion

7. Press **MODE**.
8. Press and hold together **SET + UP or DOWN Arrow** to set Fahrenheit or Celsius.



4.\_X ; X = F or C

## User Offset

9. Press **MODE**.
10. Press and hold together **SET + UP or DOWN Arrow** to set the Offset.



5.\_XX ; XX = Offset Number

## Exit

11. Press and hold together **SET then MODE** for **3 to 5 seconds** at any time to Exit.



## Turn ON/OFF 1-second delay

1. Clear **PGM** presets, Press **PGM** until all lights are off.
2. Press **MODE** button until counter appears.
3. Press and hold **SET + MODE**.

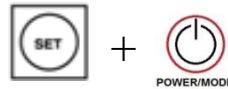

Hold until beep is heard, then release.  
**You are now in the programming settings.**

4. Press **MODE** until you see 5. XX
5. Press and hold **DOWN** arrow then **UP** arrow and hold.

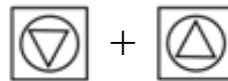

Note: press down arrow first before pressing up arrow. Hold both buttons, DO NOT release until \_\_\_\_ appears.

6. Enter code: **UP** arrow, **MODE**, **SET**, **DOWN** arrow.

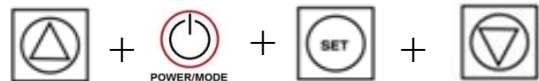

**You are now in the second tier of programming settings.**

7. Press **PGM** button until light #4 is on.
8. Press **MODE** button until you read 6. **ON/OFF**. If **ON**, turn **OFF** by holding **SET** and **UP** arrow.

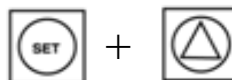

9. Once task has been completed, exit programming by holding **SET + MODE**.

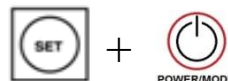

### Safety and Danger Zone Diagram

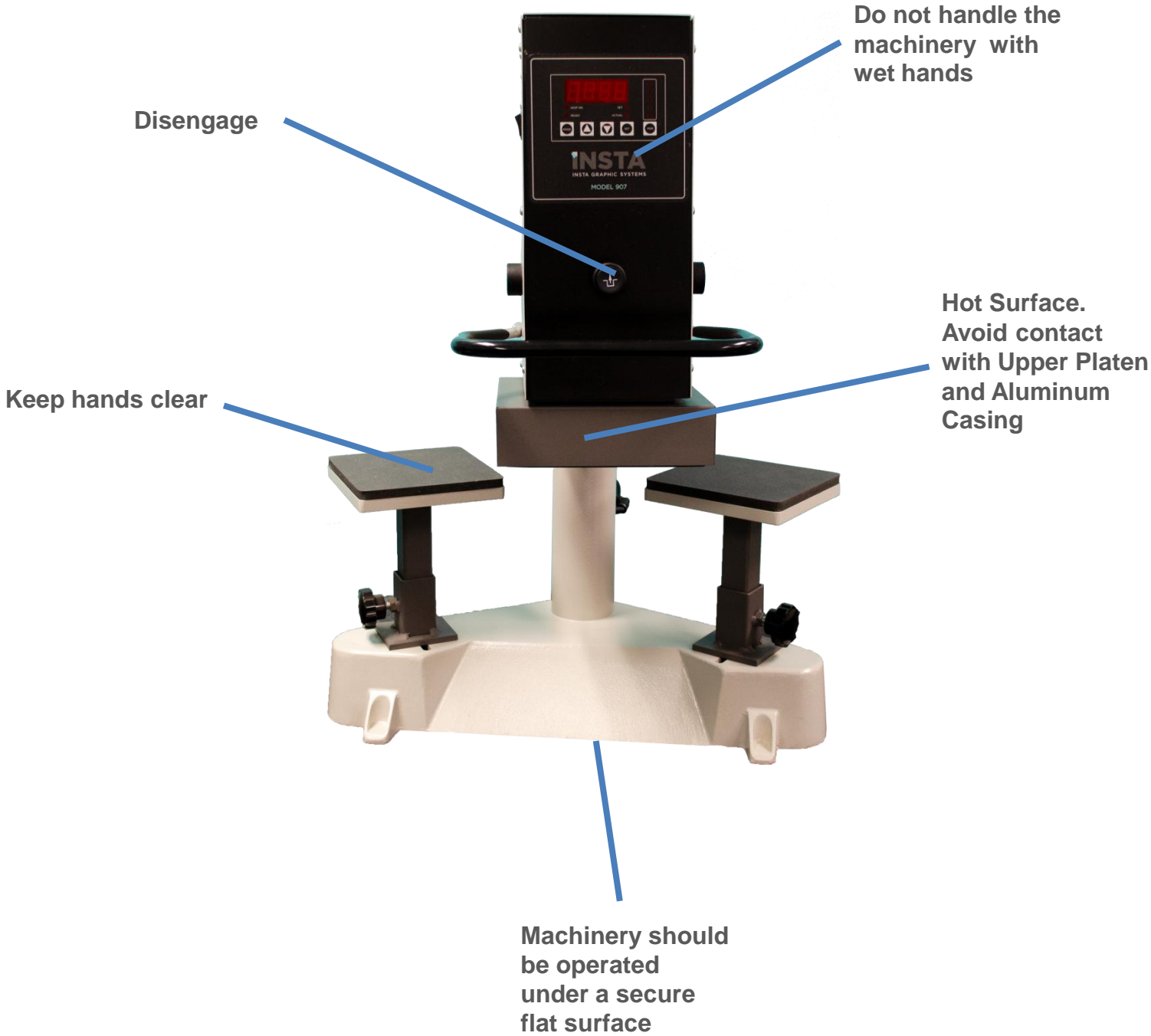

FOR USE BY QUALIFIED PERSONNEL ONLY

## 907 Wiring Diagram 0412

MODEL 907

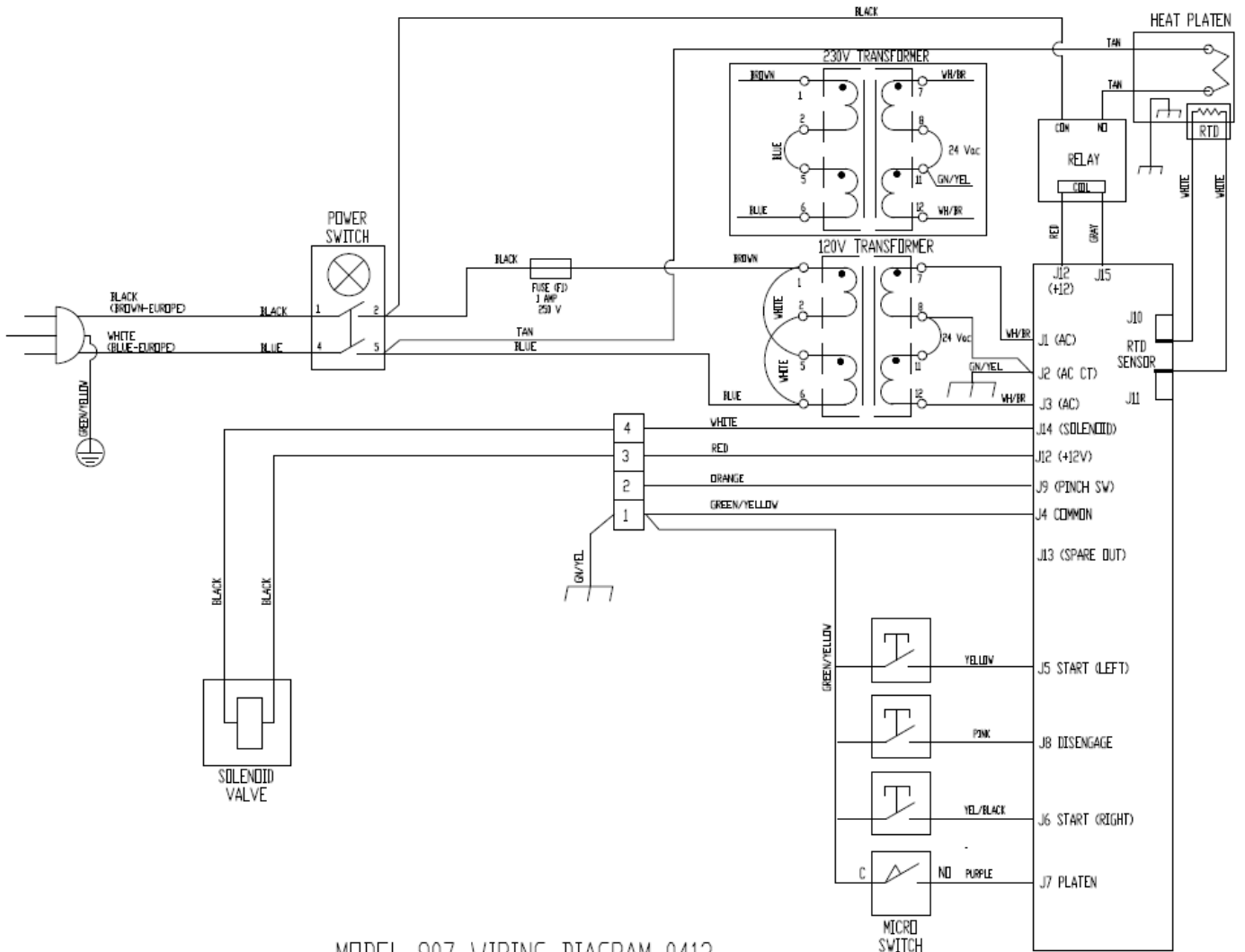

MODEL 907 WIRING DIAGRAM 0412

FOR USE BY QUALIFIED PERSONNEL ONLY

**MODEL 907**

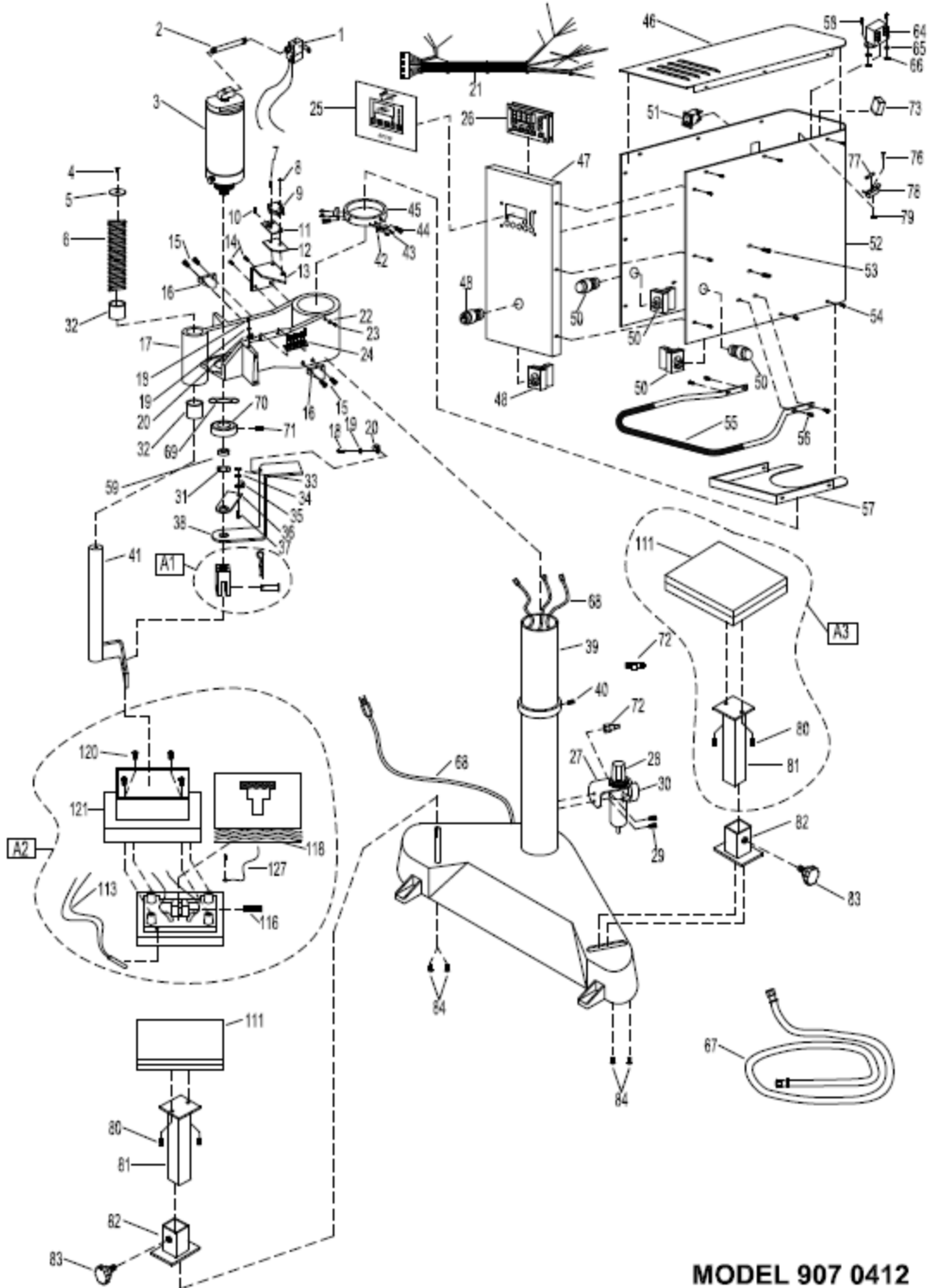

**MODEL 907 0412**

		<b>MODEL</b>	<b>MODEL</b>
		<b>907</b>	<b>907</b>
<b>NO</b>	<b>PART NAME</b>	<b>120V AC</b>	<b>230V AC</b>
1	AIR SOLENOID VALVE ASS'Y	MPPA903	MPPA903
2	NIPPLE, CYLINDER	MHN14412	MHN14412
3	AIR CYLINDER ASS'Y	MPPA413	MPPA413
4	SCREW, COMPRESSION SPRING 1/4-20 X 3/4	MHSB142034	MHSB142034
5	WASHER, SPRING	MHWC716	MHWC716
6	SPRING, COMPRESSION	MPSS884	MPSS884
7	SCREW, MICRO SWITCH 4-40 X 1/2	MHSR44012	MHSR44012
8	SCREW, MICRO SWITCH 4-40 X 3/4	MHSR44034	MHSR44034
9	MICRO SWITCH (ARM)	MPPS044	MPPS044
10	SCREW, MICRO SWITCH 8-32 X 3/8	MHSP83238	MHSP83238
11	PLATE, MICRO SWITCH MOUNTING	MH700213	MH700213
12	INSULATOR, MICRO SWITCH	MH700214	MH700214
13	BRACKET, MICRO SWITCH	MPSM90018	MPSM90018
14	SCREW, MICRO SWITCH BRACKET 10-24 X 3/8	MHSP102438	MHSP102438
15	SCREW, STOP BRACKET 1/4-20 X 1/2	MHSH142012	MHSH142012
16	BRACKET, STOP	MPSM90010	MPSM90010
17	ARM ASS'Y	MPSA90021	MPSA90021
18	SCREW, 8-32 X 3/8	MHSP83238	MHSP83238
19	WASHER	MHW SAE8	MHW SAE8
20	CLAMP, CABLE	MHCC516	MHCC516
21	WIRE HARNESS	MPPW931	MPPW932
22	WASHER	MHW SAE8	MHW SAE8
23	SCREW, 8-32 X 3/8	MHSP83238	MHSP83238
24	TERMINAL BLOCK	MPST6994	MPST6994
25	LABEL, CONTROL OVERLAY, 907	MPPL015	MPPL015
26	DIGITAL CONTROLLER	MPPT752-656	MPPT752-656
27	MOUNT, AIR REGULATOR FILTER	MPSM90009	MPSM90009
28	AIR PRESSURE/FILTER REGULATOR ASS'Y	MPR90101M	MPR90101M
29	SCREW, AIR FILTER 1/4-20 X 1/2	MHSH142012	MHSH142012
30	AIR GAUGE ASS'Y	MPPA025	MPPA025
31	NUT, JAM CLEVIS	MHJN21	MHJN21
32	BUSHING, GUIDE POST	MPSB070	MPSB070
33	NUT, HEX	MHNH832	MHNH832
34	WASHER	MHW SAE8	MHW SAE8
35	CLAMP, CABLE	MHCC516	MHCC516
36	BRACKET, WIRE STABILIZER	MPSM90019	MPSM90019
37	SCREW, 8-32 X 1/2	MHSP83212	MHSP83212
38	BRACKET, ELECTRICAL SUPPORT	MPSM90024	MPSM90024
39	BASE ASS'Y	MPSB90711	MPSB90711
40	SCREW, SOCKET 5/16-18 X 3/4	MHH5161834	MHH5161834
41	GUIDE POST ASS'Y	MPSG90008	MPSG90008
42	CAM, MICRO SWITCH	MPSC90020	MPSC90020
43	SCREW, PAN HD 6-32 X 1/4	MHSP63214	MHSP63214
44	SCREW, SOCKET HD 5/16-18 X 3/4	MHH5161834	MHH5161834
45	COLLAR, POST	MPSC90023	MPSC90023
46	PANEL, TOP COVER (SHEET METAL)	MPSM90004	MPSM90004
47	PANEL, FRONT (SHEET METAL)	MPSM90703	MPSM90703
48	DISENGAGE SWITCH ASS'Y	MPPS713	MPPS713
50	START SWITCH ASS'Y	MPPS703	MPPS703
51	POWER SWITCH (ON/OFF) ASS'Y	MPPS90337	MPPS90337
52	PANEL, WRAP AROUND (SHEET METAL)	MPSM90701	MPSM90701
53	SCREW, 10-24 X 3/8	MHSP102438	MHSP102438
54	SCREW, 6-32 X 1/4	MHP63214ST	MHP63214ST

55	HANDLE	MPSH900	MPSH900
56	SCREW, 8-32 X 1/2	MHSP83212	MHSP83212
57	PLATE, BOTTOM (SHEET METAL)	MPSM90002	MPSM90002
58	SCREW, TRANSFORMER	MHSP83238	MHSP83238
59	SPACER CYLINDER	MPS90049	MPS90049
64	TRANSFORMER	MPT90319	MPT90319
65	WASHER	MHWSAE8	MHWSAE8
66	NUT, TRANSFORMER	MHNNH832	MHNNH832
67	AIR HOSE	MPPA005	MPPA005
68	POWER CORD (USA MODEL)	MPPW161	MPPW162
68A	POWER CORD (EUROPEAN MODEL)	N/A	MPPW202
68B	POWER CORD (GREAT BRITAIN)	N/A	MPPW203
69	NUT, HEX JAM	MHNNHJ114	MHNNHJ114
70	COLLAR, PISTON SHAFT	MPSB900	MPSB900
71	SCREW, SET 1/4-20 X 3/8	MHST142038	MHST142038
72	AIR FITTING INLET	MPPF085	MPPF085
73	RELAY, SOLID STATE	MPSR2450	MPSR2450
76	SCREW, FUSE	MHSF44038	MHSF44038
77	FUSE F1 (1 AMP 250V)	MPPF701R	MPPF701R
78	FUSE HOLDER ASSEMBLY	MPPF708	MPPF708
79	NUT, FUSE	MHNNH440	MHNNH440
80	SCREW, LOWER PLATEN TUBE	MHSH142012	MHSH142012
81	LOWER PLATEN SUPPORT TUBE	MPSP477	MPSP477
82	SOCKET, LOWER PLATEN	MPSP499	MPSP499
83	KNOB, LOWER PLATEN	MH4210H	MH4210H
84	SCREW, SOCKET ATTACHMENT	MHSB142012	MHSB142012
111	SILICONE RUBBER PAD	MPPP026	MPPP026
113	SENSOR, RTD (2000 OHM)	MPPS210	MPPS210
116	PIN, UPPER PLATEN	MPPR38112	MPPR38112
118	INSULATION FIBERGLASS	MPSP249	MPSP249
120	SCREW, SHROUD (4 SET)	MHSB381612	MHSB381612
121	HEAT SHROUD	MPS90143	MPS90143
127	GROUND WIRING WITH SCREW	MPW90140	MPW90140
128	AIR REGULATOR BRACKET	MPB90901	MPB90901
<b>A1</b>	<b>CLEVIS ASS'Y</b>	<b>MPSC919</b>	<b>MPSC919</b>
<b>A2</b>	<b>UPPER PLATEN ASS'Y</b>	<b>MPP9071A</b>	<b>MPP9072A</b>
<b>A3</b>	<b>LOWER PLATEN ASS'Y</b>	<b>MPSP475</b>	<b>MPSP475</b>

## **INSTA GRAPHIC SYSTEMS Heat Press Limited Warranty**

This limited warranty (“warranty”) is given only to the original end-user/retail purchaser (referred to in this warranty as “Original Purchaser”) of the accompanying product and accessories (collectively referred to in this warranty as “The Product”).

### What is covered?

- “The Product” includes Machines, Parts and/or Accessories.
- Except as otherwise provided herein, Insta Graphic Systems (“Insta”) warrants that The Product will be free from defects in materials and workmanship when used under normal conditions.

### What is the length of the Warranty Periods?

- Machines: Life time on the heating element, one year parts and 90 days labor from the original purchase date (end-user).
- Additional Parts and Accessory Items: 90 days from the original purchase date.

### This warranty does not cover:

- Physical damage to the Product;
- Damage caused by improper installation, improper or abnormal use, misuse, neglect or accident (including but not limited to transporting The Product without the proper preparation and/or packaging);

This limited warranty is VOID, if

- the Product has been altered or modified in any way (including but not limited to attempted warranty repair without authorization from Insta and/or alteration/removal of the serial number).
- the warranty period is expired,
- the serial number label is missing or unrecognizable,
- the defect was subject to abuse, improper use not conforming to product manual instructions
- the defect was subject to Force Majeure, such as acts of God, flood, lightning, earthquake, war, vandalism, theft, brownouts or sags (damage due to low voltage disturbances)

What to do if you think your Product is eligible for warranty service: Immediately report your issue to [service@instagraph.com](mailto:service@instagraph.com) or call Insta’s Service Center at 800-421-6971 ext. 208. Supply the model, serial number and purchase date of the equipment.

### What Insta will ask you to do?

After contacting Insta you may be asked to deliver (by hand if you prefer) or send The Product properly packaged, freight prepaid, to Insta or Insta’s service center together with your bill of sale. A Return Authorization is required for all returned goods. Failure to obtain the RA will result in the refusal of the shipment.

**You are responsible for the cost of shipping, packing of The Product and insurance (if you desire). You are also responsible for loss or damage to The Product in shipping.**

If The Product does not operate as warranted above during the applicable warranty period, Insta shall, at its option and expense (except for shipping cost), repair the defective product or part, deliver to the customer an equivalent product or part to replace the defective item. All products that are replaced will become the property of Insta.



If The Product is not covered by this warranty, you will be charged for any service and/or replacement parts/products at Insta's then current published rates, as well as, for the freight.

What happens when Insta elects to replace your Machine?

When a replacement Machine is authorized by Insta, Insta will send a replacement Machine and issue a Return Authorization for the return of the Product. The Purchaser will be charged for the new machine at the time of the shipment. Once the machine is returned and the warranty confirmed, The Purchaser will receive a credit/refund. The replacement machine you receive (will be covered by the balance of the limited warranty period remaining on the original product, plus an additional thirty (30) days. You will keep the replacement machine that is sent to you and your original machine shall become the property of Insta.

THIS WARRANTY IS GIVEN IN LIEU OF ALL OTHER WARRANTIES, WRITTEN OR ORAL, WHETHER EXPRESSED BY AFFIRMATION, PROMISE, DESCRIPTION, DRAWING, MODEL OR SAMPLE. ANY AND ALL WARRANTIES OTHER THAN THIS ONE, WHETHER EXPRESSED OR IMPLIED INCLUDING IMPLIED WARRANTIES OF MERCHANTABILITY AND FITNESS FOR A PARTICULAR PURPOSE, ARE HEREBY DISCLAIMED. INSTA SHALL HAVE NO LIABILITY FOR DEFECTS OF ANY NATURE WHATSOEVER EXCEPT AS PROVIDED FOR HEREIN.

This Limited Warranty (and Insta's obligation to you) may not be changed in any way unless you and Insta sign the same piece of paper in which we (1) refer to The Product and your bill of sale date, (2) describe the change to this warranty and (3) agree to make that change.

**Important:**

We recommend that you keep all original packing materials, in the event that you need to ship the Product.

FOR USE BY QUALIFIED PERSONNEL ONLY

FOR USE BY QUALIFIED PERSONNEL ONLY

FOR USE BY QUALIFIED PERSONNEL ONLY



**13925 E. 166<sup>th</sup> St. • Cerritos, CA USA 90702 • (562) 404-3000 • Fax (562) 404-3010**  
**Technical Support • (800) 426-3609**