



b05
ACADEMY

User manual

bernette

SWISS DESIGN

Table of Contents

IMPORTANT SAFETY INSTRUCTIONS	5	Threading the upper thread	26
Important information	7	Threading the double needle	30
1 My bernette	9	Threading the Triple Needle	30
1.1 Overview Machine	9	Winding the bobbin thread	31
Overview front	9	Threading the bobbin thread	33
Overview top	10	Pulling up the bobbin thread	34
Overview back	11	3 Creative sewing	36
1.2 Accessory	11	3.1 Selecting a stitch pattern	36
Included accessories	11	3.2 Editing stitch patterns	37
Overview presser feet	12	Setting the stitch width	37
1.3 Needle, Thread, Fabric	13	Adjusting the stitch length	37
Overview Needles	14	Adjusting the upper thread tension	37
Needle/thread combination	15	Adjusting the balance	38
Example for needle description	16	3.3 Quick reverse	39
Thread selection	16	3.4 Securing	40
2 Sewing preparation	17	3.5 Sew thick areas	40
2.1 Connection and Switching on	17	3.6 Sewing Corners	41
Connecting the machine and foot control	17	3.7 Sewing very slippery fabrics	41
Switching the machine on	17	4 Practical stitches	42
Regulating the speed via the foot control	17	4.1 Overview Practical stitches	42
2.2 Spool pin	18	4.2 Sewing straight stitch	43
Horizontal spool pin	18	4.3 Sewing in the zipper	44
Second spool pin	19	4.4 Stitching in a concealed zipper	45
2.3 Free arm	19	4.5 Sewing Triple straight stitch	47
2.4 Sewing table with accessory box	20	4.6 Sewing Triple zigzag	48
2.5 Raising or Lowering the Feed dog	20	4.7 Super-stretch	48
2.6 Using the slide-on table	20	4.8 Sewn-out Zig zag	48
2.7 Needle	21	4.9 Manual darning	49
Raising and lowering the needle	21	4.10 Finishing edges	50
Changing the needle	21	4.11 Sewing Double overlock	51
Adjusting the needle position	22	4.12 Sewing Vari overlock	51
2.8 Presser foot	23	4.13 Narrow edgestitching	52
Raising and lowering the presser foot	23	4.14 Wide edgestitching	52
Changing the presser foot sole	23	4.15 Edgestitching using the seam guide	53
Adjusting the presser foot pressure	24	4.16 Sewing hem edges	53
Fitting finger guard	25		
2.9 Threading	26		
Threading preparation	26		

Table of Contents

4.17	Sewing a narrow hem	53	9	Troubleshooting	74
4.18	Sewing blind hems	55	10	Technical data	76
4.19	Sewing visible hems	56	11	Appendix	77
4.20	Sewing flat joining seams	56	11.1	Overview stitch patterns	77
4.21	Sewing basting stitches	56		Overview of the stitch patterns	77
5	Decorative stitches	57		Index	78
5.1	Overview Decorative Stitches	57			
5.2	Altering the stitch density	58			
5.3	Gathering stitches	58			
	Gathering	58			
	Smocking	58			
5.4	Connecting stitches	59			
	Joining seam with faggot stitch	59			
	Joining seam with double overlock stitch	60			
5.5	Edging	60			
	Shell edging with Vari-overlock stitch	60			
	Shell edging with satin stitch	61			
6	Buttonholes	62			
6.1	Overview Buttonholes	62			
6.2	Marking buttonholes	62			
6.3	Determining the buttonhole length	62			
6.4	Reinforce buttonhole	62			
6.5	Sewing a test sample	63			
6.6	Sewing a buttonhole automatically	63			
6.7	cut the buttonhole open	65			
6.8	Sewing on buttons	65			
7	Quilting	67			
7.1	Overview Quilt Stitches	67			
7.2	Appliqués	67			
7.3	Guiding the quilt work freely	67			
7.4	Sewing patchwork	68			
8	Maintenance and cleaning	70			
8.1	Cleaning the feed dog	70			
8.2	Cleaning the hook	71			
8.3	Oiling the needle bar	72			

IMPORTANT SAFETY INSTRUCTIONS

Please be aware of the following basic safety instructions when using your machine. Before using this machine, read instruction manual carefully.

DANGER!

To reduce the risk of electrical shock:

- Never leave the machine unattended as long as it is plugged in.
- Always unplug the machine from the electrical outlet immediately after using.

Protection against LED radiation:

- Do not view the LED light directly with optical instruments (e.g. magnifier). The LED light corresponds with protection class 1M.
- When the LED light is damaged or defective, contact your bernette specialist dealer.

WARNING

To reduce the risk of burns, fire, electric shock or injury to persons:

- To operate the machine always use the supplied power cable. USA and Canada only: Do not connect power plug NEMA 1-15 to circuits exceeding 150 volt-to-ground.
- Use this machine only for purposes as described in this manual.
- Only use the machine in dry rooms.
- Do not use the machine in a damp condition or in a damp environment.
- Do not use this machine as a toy. Close attention is necessary when this machine is used by or near children.
- The machine can be used by children older than 8 or by people with reduced physical, sensory or mental capabilities or if there is a lack of experience and knowledge how to operate the machine as long as they are supervised or have been given instruction concerning the responsible use of the appliance and are aware of the involved risks.
- Children are not allowed to play with this machine.
- Cleaning and maintenance work must not be carried out by children unless they are supervised.
- Never operate this machine if it has a damaged cord or plug, if it is not working properly, if it has been dropped or damaged, or dropped into water. Never operate this machine if it has a damaged cord or plug, if it is

not working properly, if it has been dropped or damaged, or dropped into water. Contact the nearest authorized bernette dealer to arrange further details.

- Only use accessory recommended by the manufacturer.
- Don't use this machine when the ventilation openings are blocked. Keep the ventilation openings and the foot control free from the accumulation of lint, dust and loose cloth.
- Never insert any objects into any openings of the machine.
- Do not place any objects on the foot control.
- Always use the machine with a foot control of this type KD-2902/KD-1902.
- Do not operate the machine where aerosol products (sprays) or oxygen are being used.
- Keep fingers away from all moving parts. Special care is required around the needle.
- Neither pull nor push the fabric while sewing. This can cause needle breakage.
- When making any adjustments in the needle area – such as such as threading the needle, changing the needle, threading the hook or changing the presser foot – turn power switch to «0».
- Do not use bent needles.
- Always use the original bernette stitch plate. The wrong plate can cause needle breakage.
- To disconnect, turn power switch to "0" and then remove the plug from the outlet. Do not unplug by pulling the cord, instead grasp the plug to pull it from the outlet.
- Always disconnect the power plug from the electrical outlet when the covers are removed or opened, when the machine is lubricated or during any other maintenance adjustments mentioned in the instruction manual.
- This machine is provided with double insulation (except USA, Canada and Japan). Use only identical replacement parts. See instructions for Servicing of double-insulated products.
- The sound pressure level under normal conditions is less than 80 dB (A).

Important information

Availability of the instruction manual

The short manual is part of the machine.

- Keep the short manual of the machine in a suitable place near the machine and have it ready for reference.
- The latest version of the detailed instruction manual can be downloaded at www.mybernette.com.
- When passing on the machine to a third party, enclose the short manual of the machine.

Proper use

Your bernette machine is conceived and designed for private household use. It is intended for sewing fabrics and other materials as described in this instruction manual. Any other use is not considered proper. BERNINA assumes no liability for consequences resulting from improper use.

Equipment and scope of delivery

Example images are used in these operating instructions for the purposes of illustration. The machines shown in the images and the accessories shown therefore do not always match the actual items included with your machine. The supplied accessory can vary depending on the country of delivery. You can acquire any accessories mentioned or shown that are not included in the scope of delivery as optional accessories from a specialist bernette dealer. Further accessories can be found at www.mybernette.com.

For technical reasons and in order to improve the product, changes may be made to the equipment of the machine and the scope of delivery at any time and without prior notice.

Maintenance of double-insulated products

In a double-insulated product, two systems of insulation are provided instead of grounding. No grounding means is provided on a double-insulated product nor should a means for grounding be added to the product. Servicing a double-insulated product requires extreme care and knowledge of the system and should only be done by qualified service personnel. Only original spare parts should be used for service and repairs. A double-insulated product is marked with the words: «Double-Insulation »or «double-insulated».



The symbol may also be marked on the product.

Environmental Protection

BERNINA is committed to the protection of the environment. We strive to minimize the environmental impact of our products by continuously improving product design and our technology of manufacturing.



The machine is labeled with the symbol of the crossed-out wastebbin. This means that the machine should not be disposed of in household waste when it is no longer needed. Improper disposal can result in dangerous substances getting into the groundwater and thus into our food chain, damaging our health.

The machine must be returned free of charge to a nearby collection point for waste electrical and electronic equipment or to a collection point for the reuse of the machine. Information on the collection points can be obtained from your local administration. When purchasing a new machine, the dealer is obliged to take back the old machine free of charge and dispose of it properly.

If the machine contains personal data, you are responsible for deleting the data yourself before returning the machine.

Explanation of symbols



Designates a high-risk hazard which can lead to serious injuries or potentially even death if not avoided.



Designates a medium-risk hazard which can lead to serious injuries if not avoided.



Designates a low-risk hazard which can lead to minor or moderate injuries if not avoided.



Designates a hazard which can lead to material damage if not avoided.

1 My bernette

1.1 Overview Machine

Overview front

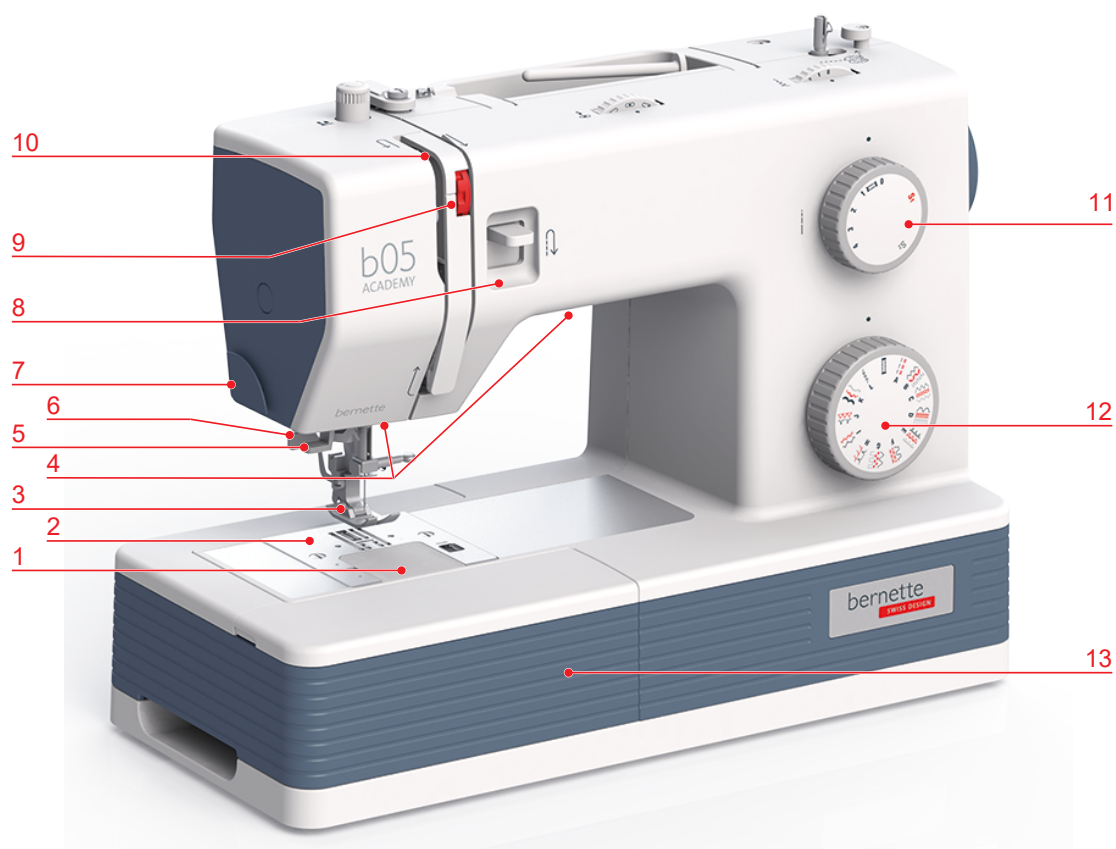

- | | | | |
|---|--------------------|----|--------------------------------|
| 1 | Stitch plate cover | 8 | Reverse sewing lever |
| 2 | Stitch plate | 9 | Thread tension dial |
| 3 | Presser foot | 10 | Thread take-up lever |
| 4 | Sewing light | 11 | Stitch length knob |
| 5 | Needle threader | 12 | Stitch pattern selector knob |
| 6 | Buttonhole lever | 13 | Sewing table and accessory box |
| 7 | Thread cutter | | |

Accessory box

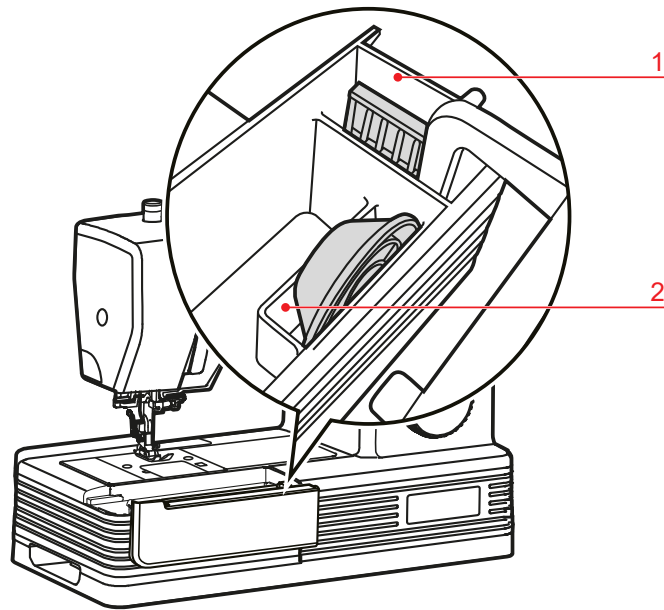

1 Compartment for needle set

2 Compartment for spool disc

Overview top

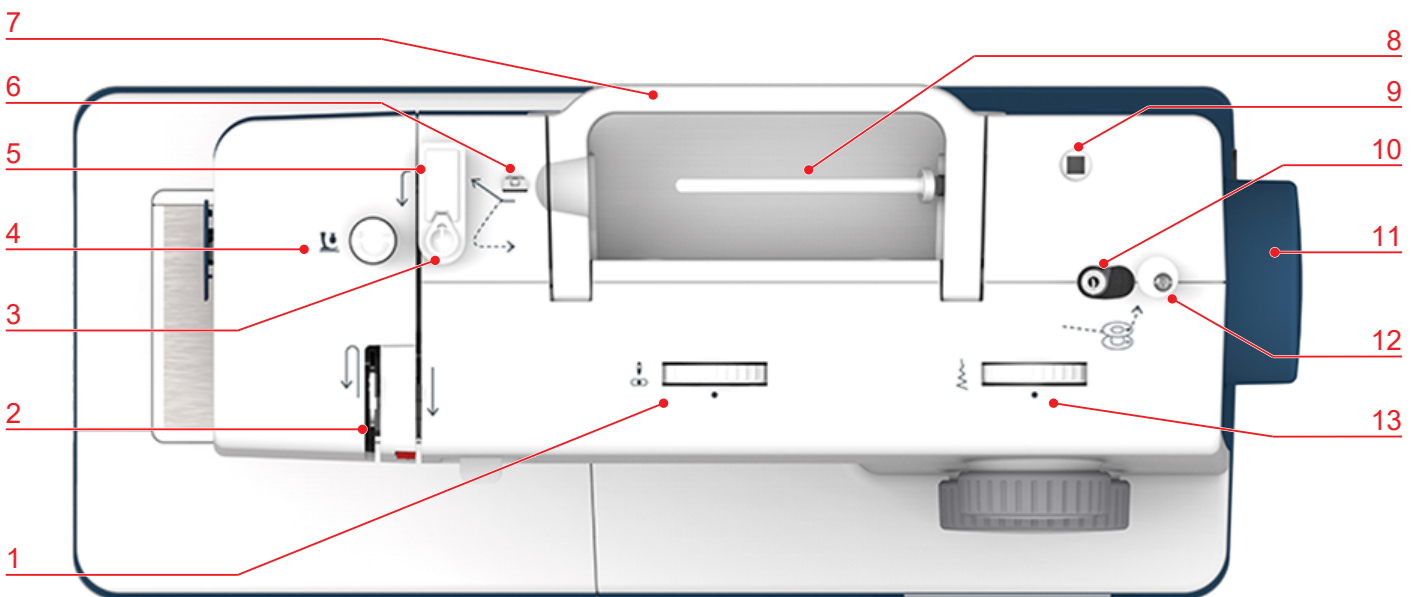

1 Needle position dial

2 Thread take-up lever

3 Bobbin winder pre-tension

4 Presser foot pressure adjustment knob

5 Thread pretension

6 Thread guide

7 Carrying handle

8 Spool pin

9 Opening, additional spool pin

10 Bobbin winder unit

11 Handwheel

12 Bobbin winder unit stopper

13 Stitch width dial

Overview back

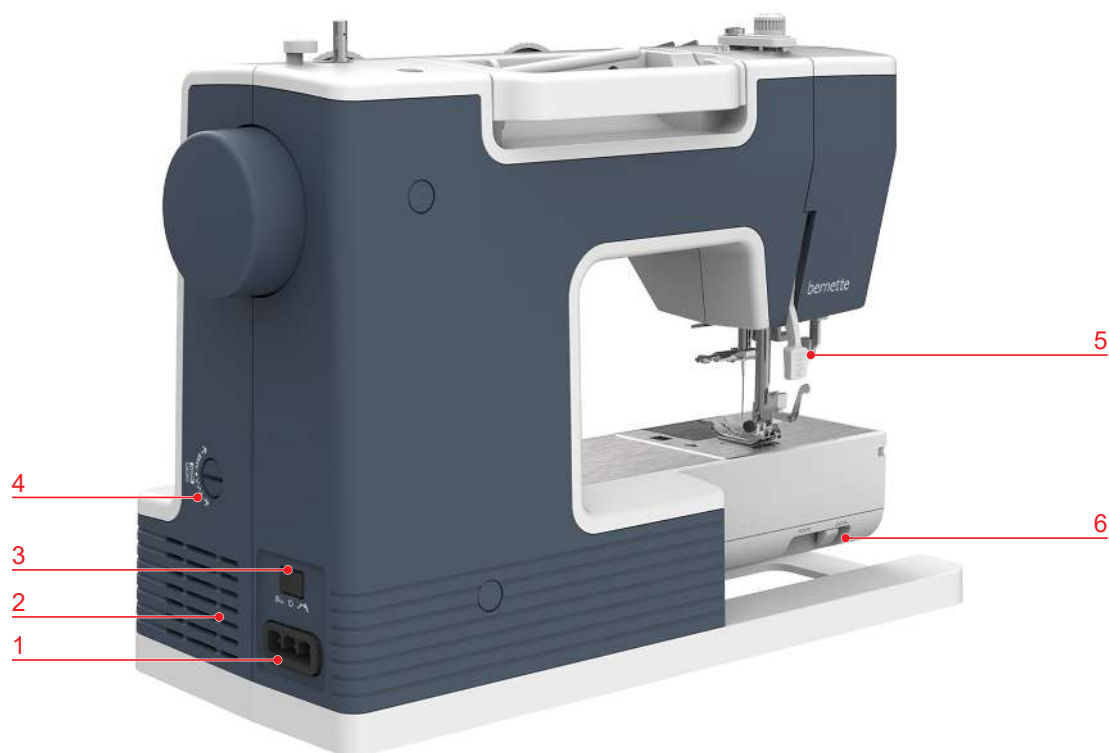

- | | | | |
|---|-------------------------------------|---|---------------------|
| 1 | Power cable/foot control connection | 4 | Balance dial |
| 2 | Air vents | 5 | Presser foot lifter |
| 3 | Main switch with speed limit | 6 | Feed dog lever |

1.2 Accessory

Included accessories

Visit www.mybernette.com/accessories for more accessory information.





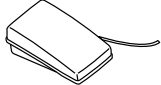
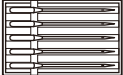
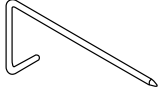
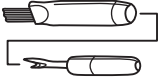

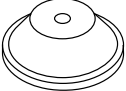
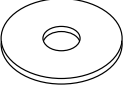

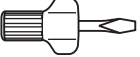
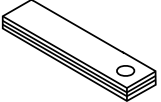

Figure	Name	Figure	Name
	Bobbin (3x)		Second spool pin
	Spool net		Foot control with power cable
	Selection of needles		Seam guide

Figure	Name	Figure	Name
	Brush and seam ripper		Oiler
	Spool disc, large (1x)		Felt disc
	Spool disc, small (1x)		Screwdriver
	Height compensating tool		Finger guard
	Extension table		

Overview presser feet

Illustration	Name	Purpose
	Zigzag foot	For sewing different practical and decorative stitches and for sewing hems.
	Zipper foot	For sewing in zippers.
	Buttonhole foot with slide	For sewing buttonholes with or without filler cord.
	Blindstitch foot	For sewing blind-stitch hems
	Overlock foot	For sewing overlock-type stitches and for finishing the edge of the fabric.

Illustration	Name	Purpose
	Zipper foot for concealed zippers	For sewing in concealed zippers.
	Darning foot/embroidery foot	For embroidering, darning and freehand quilting.
	Button-sew-on foot	For sewing on buttons of different sizes with 2 or 4 holes.
	Hemmer foot	To sew double-turned hems.
	Open transparent embroidery foot	For sewing buttonhole stitches, appliqués and decorative stitches.
	Zigzag foot with sliding sole	For sewing different practical and decorative stitches. For hemming very slippery materials such as leather, plastic, vinyl or similar materials.
	Edgestitch foot	For stitching edges, hems and pleats. For stitching seams and hems that run parallel to an edge. For sewing on lace or braid.

1.3 Needle, Thread, Fabric

Needles will wear down over time. Therefore, the needle should be replaced regularly. Only a perfect point results in a good stitching result. In general, the thinner the fabric, the finer the needle. The illustrated needles are either standard or optional accessory, depending on the machine.

- Needle sizes 70, 75: for light-weight fabrics.
- Needle sizes 80, 90: for medium fabrics.
- Needle sizes 100, 110: for heavy fabrics.

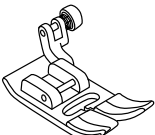
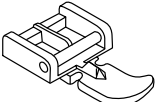
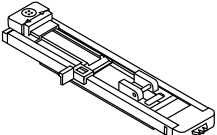
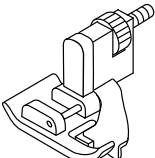
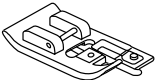
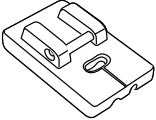
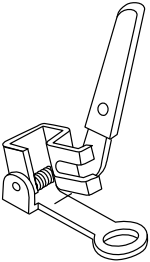
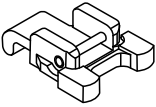
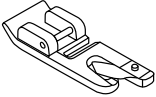
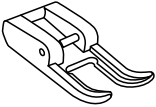
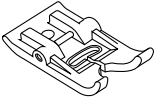
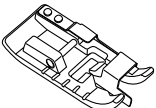
Overview Needles

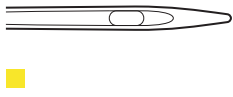

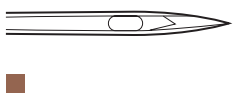
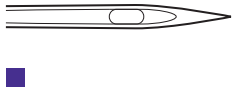

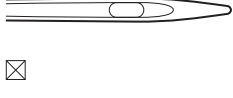
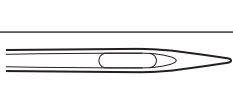
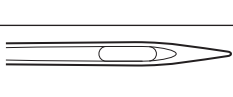





Illustration	Needle name	Needle description	Purpose
	Universal needle 130/705 H 70-110	Slightly rounded point	For nearly all natural and synthetic fabrics (woven and knitted).
	Stretch needle 130/705 H-S 75, 90	Mid-sized ball point, special eye shape and needle scarf	For jersey, tricot, knit and stretch fabrics.
	Jersey/Embroidery needle 130/705 H SUK 70-100	Medium ball point	For knitware, knitted good. For embroidering.
	Jeans needle 130/705 H-J 80-110	Point, narrow point, reinforced shaft	For heavy-weight fabrics such as jeans or canvas.
	Leather needle 130/705 H LR 90, 100	With cutting point (LR = special point to sew leather)	For all types of leather, synthetic leather, plastic, sheeting.
	Microtex needle 130/705 H-M 70-110	Especially sharp, narrow tip	For micro fiber fabrics and silk.
	Quilting needle 130/705 H-Q 75, 90	Slightly rounded fine point	For straight and topstitching.
	Embroidery needle 130/705 H-E 75, 90	Small ball point, especially wide needle eye and wide thread groove	For embroidery on all natural and synthetic fabrics.
	Fine-material needle 130/705 H SES 70, 90	Small ball point	For fine knitware and knitted materials. For embroidery on fine, delicate fabrics.
	Metafil needle 130/705 H METAFIL 80	Long needle eye (2 mm) in all needle sizes	For sewing or embroidering with metallic threads.
	Cordonnet needle (to patch embroidery) 130/705 H-N 70-100	Long needle eye (2 mm) in all needle sizes	Topstitching with thick thread.

Illustration	Needle name	Needle description	Purpose
 ☒	Hemstitch needle 130/705 H WING 100–110	Wing-like widened needle shaft (wing)	To sew blind stitches.
 ☒	Universal twin needle 130/705 H ZWI 70-100	Needle distance: 1.0/1.6/2.0/2.5/ 3.0/4.0	For visible hems in stretch fabrics, pintucks, decorative sewing.
 ☒	Stretch double needle 130/705 H-S ZWI 75	Needle distance: 2.5/4.0	For visible hems in stretch fabrics, pintucks, decorative sewing.
 ☒	Hemstitch double needle 130/705 H ZWIHO 100	Needle distance: 2.5	For special effects with hemstitch embroidery.
 ☒	Universal triple needle 130/705 H DRI 80	Needle distance: 3.0	For visible hems in stretch fabrics, decorative sewing.

Needle/thread combination

	The needle/thread combination is correct, when the thread fits perfectly into the long groove and goes easily through the needle eye. This allows the thread to be stitched optimally.
	If the thread has too much room to move in the long groove and in the needle eye, this can result in the thread breaking or missing stitches.
	If the thread rubs along the edge of the long groove and cannot be guided properly through the needle eye, this can result in the thread breaking or jamming.

Example for needle description

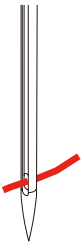
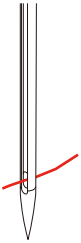
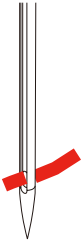
The 130/705 system, which is the most common for household machines, is explained by the following picture of a Jersey/Stretch needle.

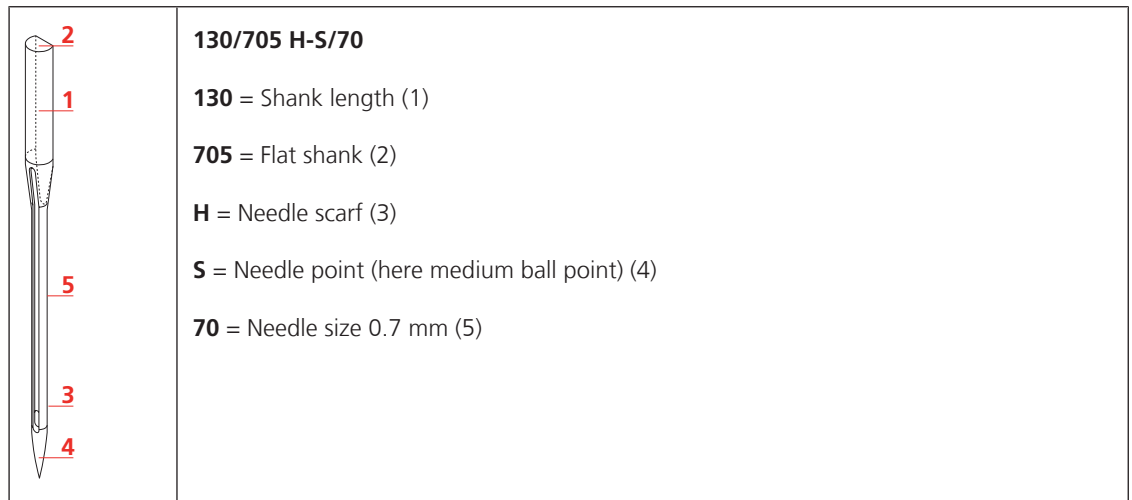

Thread selection

For a perfect sewing result, thread and fabric quality play an important role.

We recommend purchasing quality threads to achieve good sewing results.

- Cotton threads have the advantage of being a natural fiber and therefore are especially suitable for sewing cotton fabrics.
- Mercerized cotton threads have a slight sheen that is not lost with washing.
- Polyester threads have a high tensile strength and is particularly colorfast.
- Polyester threads are more flexible and are recommended where a strong and elastic seam is required.
- Rayon threads are made of natural fibers and have a brilliant sheen.
- Rayon threads are suitable for decorative stitches and achieve a more beautiful effect.

2 Sewing preparation

2.1 Connection and Switching on

Connecting the machine and foot control

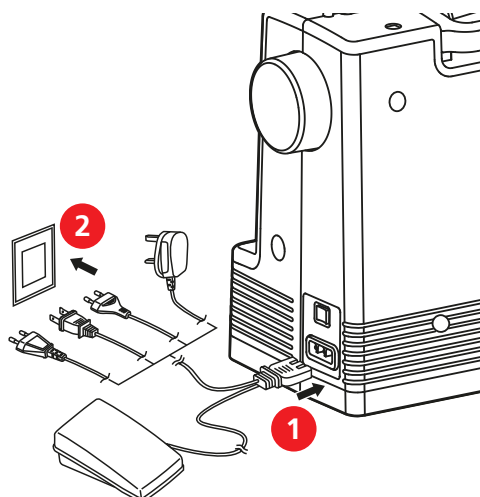

- > Insert the equipment plug (1) for the power and foot control cable into the power cable connection.
- > Insert the power plug (2) for the power and foot control cable into the socket.

Use of the power cable (only USA/Canada)



The machine has a polarized plug (one contact is wider than the other). To reduce the risk of electric shock, the plug can only be plugged into the socket in one way. If the plug does not fit into the socket, turn the plug. If it still does not fit, contact an electrician to install an appropriate outlet. Do not modify the plug in any way.

Switching the machine on

The main switch has two switch-on settings:

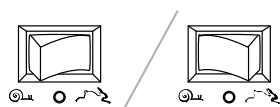
- Quick sewing.
- Slow sewing.



- > To sew quickly, set the main switch to the  symbol.
 - The maximum sewing speed is 1100 stitches per minute.
- > To sew slowly, set the main switch to the  symbol.
 - The maximum sewing speed is 650 stitches per minute.

Regulating the speed via the foot control

The sewing speed can be continuously adjusted using the foot control.

- > Press the foot control down carefully to start the machine.
- > To sew more quickly, press the foot control further down.

- > Release the foot control to stop the machine.

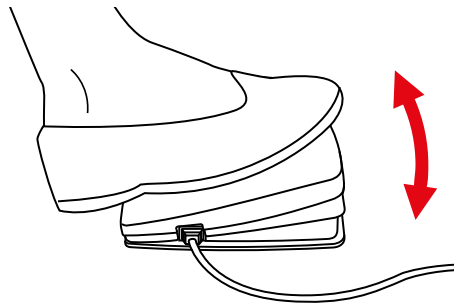

2.2 Spool pin

Horizontal spool pin

Placing the thread spool and the thread disc

Spool discs hold the thread spool in place for proper release of thread from the spool.

- > Place the spool on the spool pin.
- > Place a suitable spool disc on the spool such that there is no clearance between the spool disc and the spool.

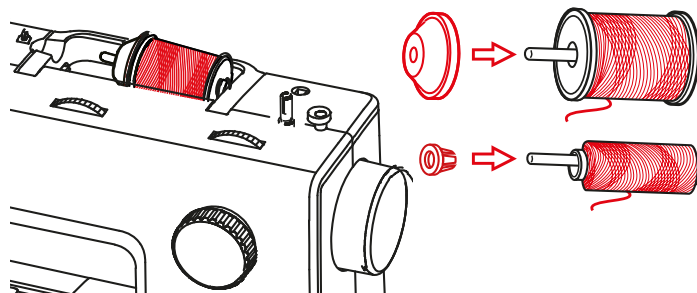

Using a spool net

The spool net provides an even unwinding of the thread from the thread spool and prevents the thread from knotting and breaking. The spool net is only used with the horizontal spool holder.

- > Pull the spool net over the thread spool.

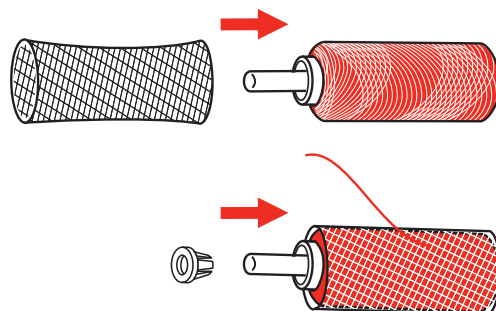

Second spool pin

Inserting the second spool pin

The second spool pin is required when sewing with multiple threads or for winding the bobbin thread.

- > Insert the second spool pin in the accessories opening on the machine cover.

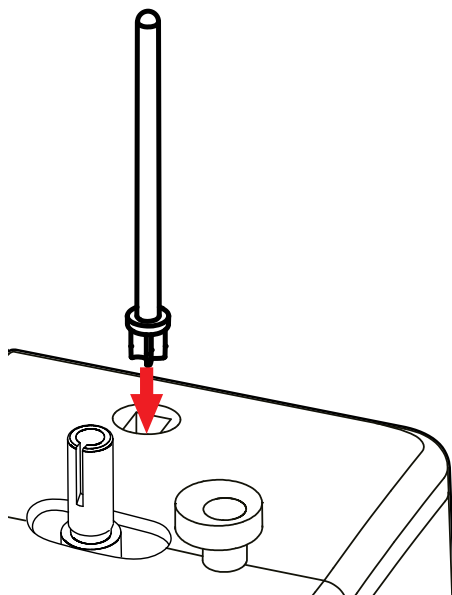

Inserting thread spool

- > Place the felt disc on the spool pin.
 - The felt disc prevents the thread from sticking to the spool pin.
- > Place the thread spool on the second spool pin.

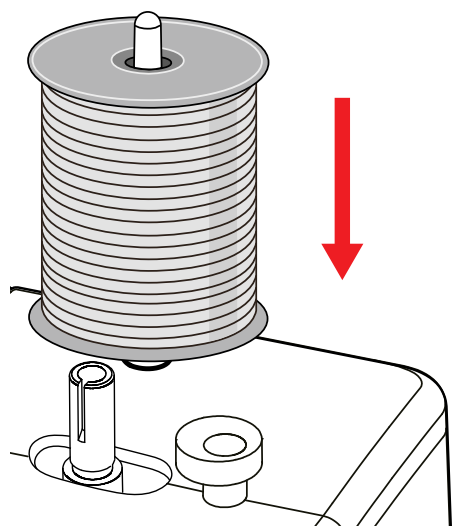

2.3 Free arm

The bennette b05 provides a solidly designed free arm which offers a lot of space for large project on the right of the needle.

2.4 Sewing table with accessory box

The sewing table has an integrated accessory box.

- > To remove the sewing table, hold the sewing table by the handle (1) and pull it away to the left.

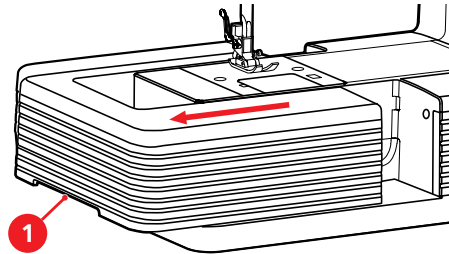

- > To open the accessory box, tilt the cover towards you.

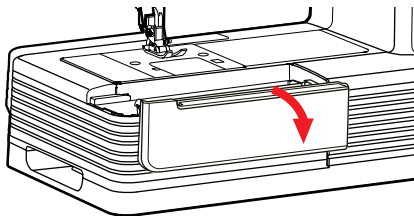

- > To close the accessory box, fold the lid downwards at an angle.

2.5 Raising or Lowering the Feed dog

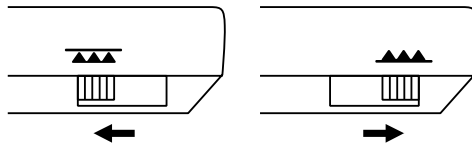

- > To raise the feed dog, push the feed dog lever to the right.
 - The feed dog is raised when the first stitch is sewn.
- > Slide the «Feed dog lever» left to lower the feed dog.
 - The feed dog is lowered.

2.6 Using the slide-on table

The extension table, attached to the free arm, enables the available sewing area to be extended.

The height of the extension table can be adjusted by turning the adjustable feet.

Prerequisite:

- The sewing table is removed.
- > Unfold the feet on the extension table.

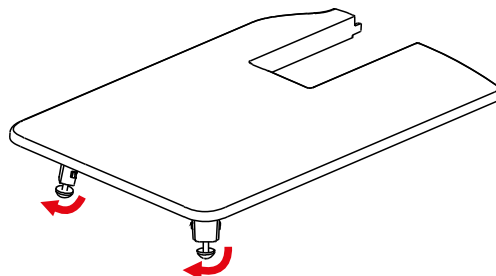

- > Push the extension table from the left to the right over the free arm until it engages.

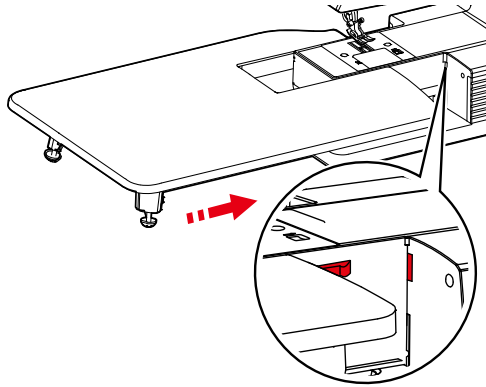

- > To remove the slide-on table, pull the slide-on table over the free arm to the left.

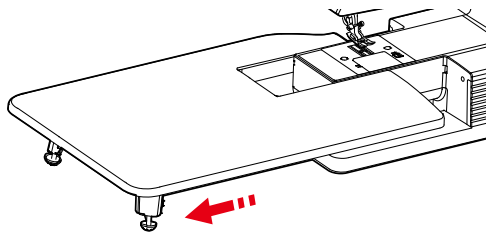

2.7 Needle

Raising and lowering the needle

- > To raise the needle, turn the handwheel anti-clockwise until the needle is in the highest position.

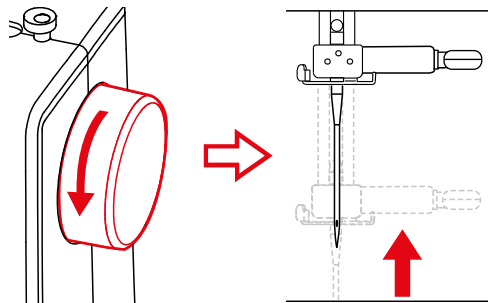

- > To lower the needle, continue turning the handwheel anti-clockwise until the needle pierces the fabric.

Changing the needle

- > Switch off the machine and disconnect it from the power supply.
- > Raise the presser foot.
- > Raise the needle.
- > Loosen the fixing screw (1) using the screwdriver.

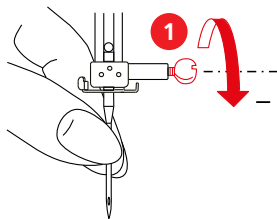

- > Pull the needle out in a downward direction.

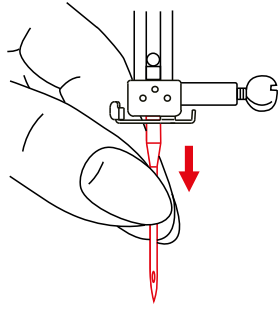

- > Hold the new needle (2) with the flat side to the rear. Push the needle upwards into the needle holder as far as it will go (3).

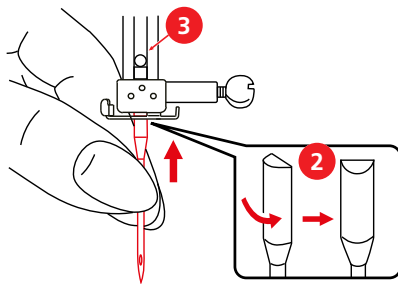

- > Tighten the fixing screw by hand.

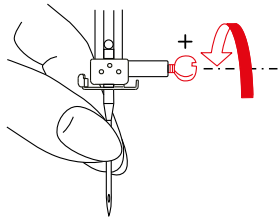

Adjusting the needle position

- > Raise the needle.
- > Use a recommended presser foot.
- > Set the required needle position using the needle position dial.



2.8 Presser foot

Raising and lowering the presser foot

- > To raise the presser foot, push the presser foot lever upwards.

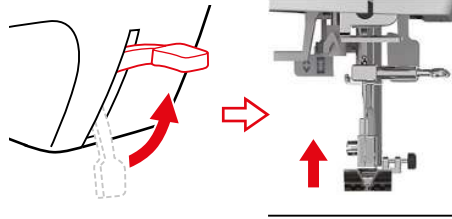

- > To lower the presser foot, push the presser foot lever downwards.

Changing the presser foot sole

Removing the presser foot sole

- > Switch off the machine and disconnect it from the power supply.
- > Raise the presser foot.
- > Raise the needle.
- > To remove the presser foot sole, push the lever on the rear of the presser foot holder upwards.

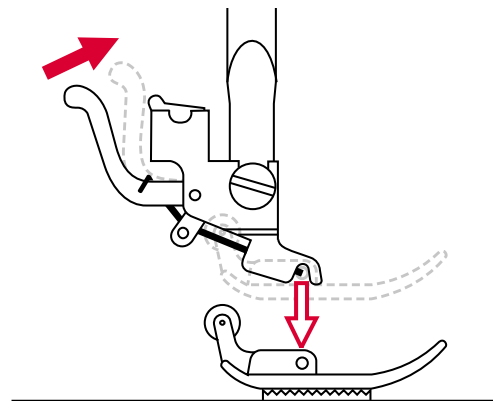

Fitting the presser foot sole

Prerequisite:

- The presser foot sole is removed.
- > Raise the presser foot.

NOTICE

Needle breakage caused by incorrect presser foot

If the presser foot is not suitable for the selected stitch, the needle may collide with the presser foot and break.

- > Always use a presser foot that is suitable for the stitch.

- > Position the new presser foot sole under the notch in the shaft (1) so that the notch in the shaft is positioned above the presser foot sole pin (2).

- > Carefully lower the presser foot lifter until the notch in the shaft engages with the presser foot sole pin.

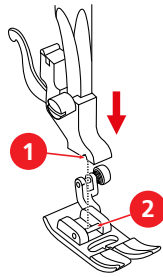

Removing and inserting the presser foot holder

Prerequisite:

- The presser foot sole is removed.
- > Raise the presser foot.
- > Align the presser foot holder (1) with the presser foot bar (2) underneath and to the left.
- > Hold the presser foot holder firmly and screw in the screw by hand.
- > Tighten the screw using the screwdriver.

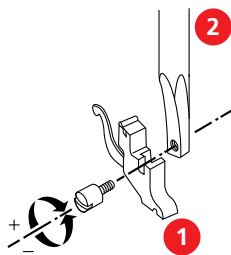

Inserting the edge/ quilting guide

The seam guide is suitable for sewing parallel lines.

- > Insert the seam guide (1) into the hole in the presser foot holder (2).
- > Set the required distance to the adjacent seam.

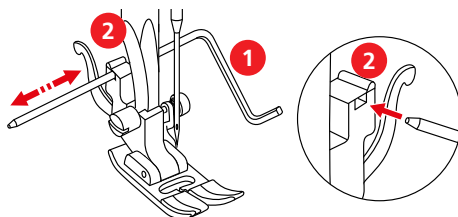

Adjusting the presser foot pressure



The presser foot pressure is designed to adjust the pressure of the presser foot optimally to the fabric thickness. When working with thick fabrics, it is recommended to reduce the presser foot pressure. This provides the advantage that the presser foot is slightly lifted so that the fabric can be moved more easily. When working with thin fabrics, it is recommended to increase the presser foot pressure. This provides the advantage that the fabric cannot be moved too easily under the presser foot.

- > To increase the presser foot pressure, turn the «Presser foot pressure» adjustment knob clockwise.

- > To reduce the presser foot pressure, turn the «Presser foot pressure» adjustment knob anti-clockwise.

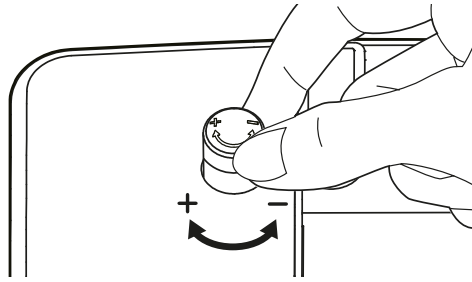

Fitting finger guard

The finger guard reduces the risk of the user's fingers moving too close to the needle during sewing, resulting in injury.

- > Raise the presser foot.
- > Remove the presser foot.
- > Loosen the screw on the presser foot holder and remove the presser foot holder.

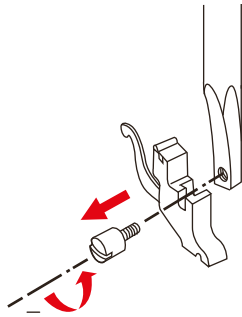

- > Attach the finger guard to the screw.

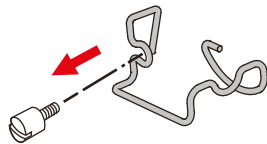

- > Hold the presser foot holder by the presser foot bar and screw it in using the screw.

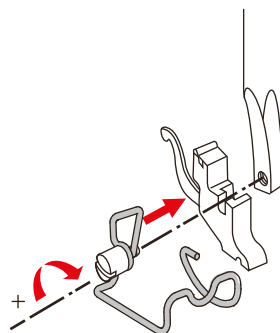

- > Fit the presser foot sole.

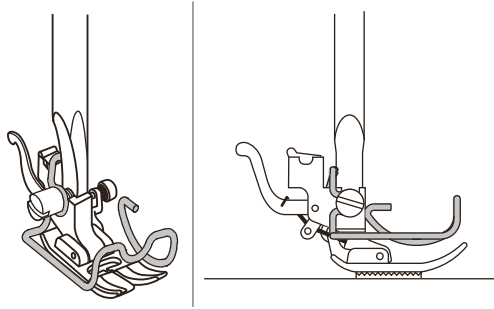

- > Check whether the finger guard is aligned parallel to the presser foot sole.
- > If necessary, loosen the screw to align the finger guard.

2.9 Threading

Threading preparation

- > Switch the machine off.
- > Raise the needle.
- > Raise the presser foot.

Threading the upper thread

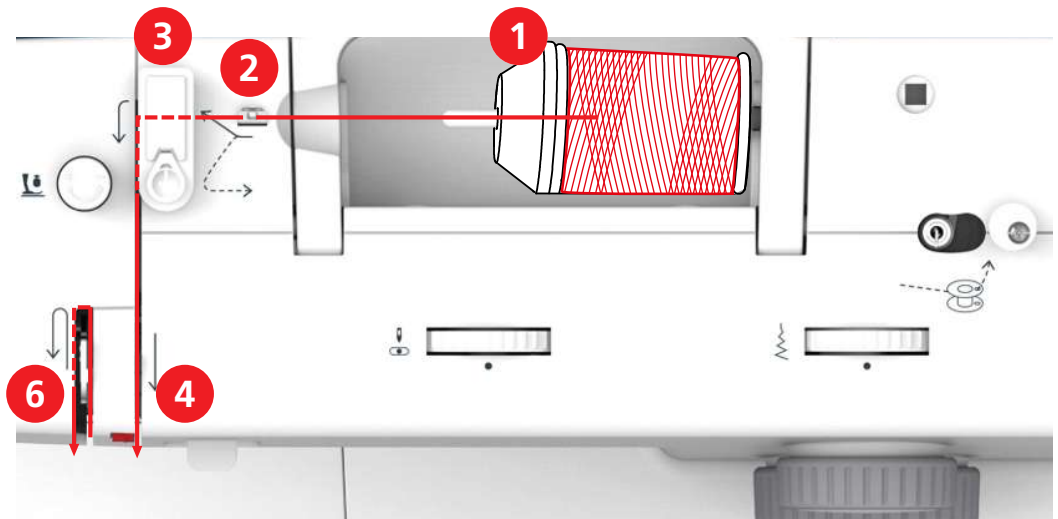

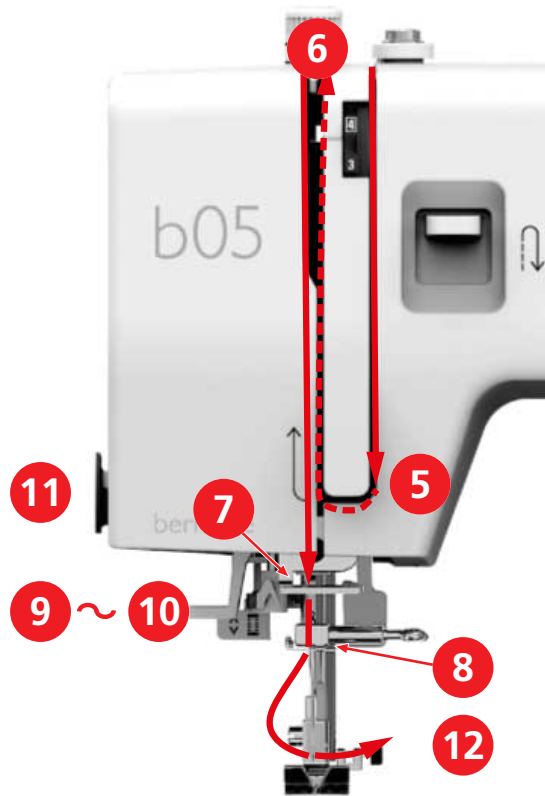

- | | | | |
|---|----------------------------|----|------------------------|
| 1 | Spool disc | 7 | Guide |
| 2 | Thread guide | 8 | Guide |
| 3 | Thread pretension | 9 | Needle-threading lever |
| 4 | Thread tension discs | 10 | Wire hook |
| 5 | Thread take-up lever cover | 11 | Thread cutter |
| 6 | Thread take-up lever | 12 | Thread |

- > Place the thread spool on the spool holder so that the thread unwinds clockwise.
- > Fit the spool disc suitable for the spool.
- > Guide the thread through the thread guide.

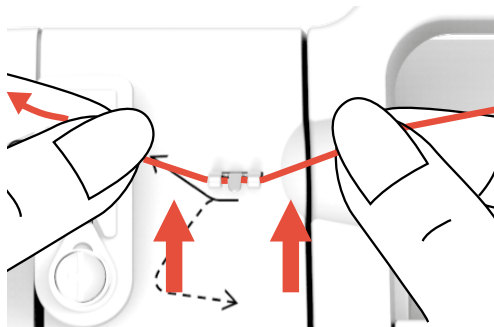

- > Guide the thread through the thread pretension.

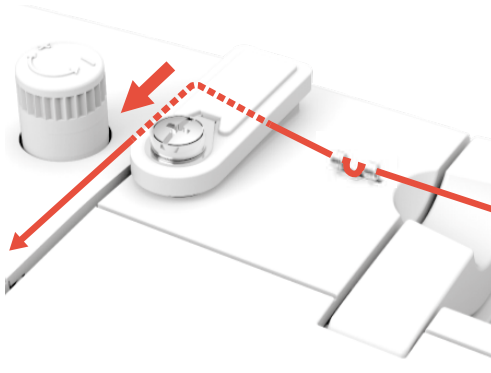

- > Guide the end of the thread downwards along the channel.

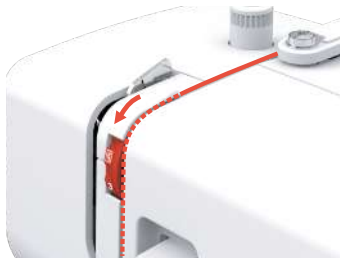

- > Guide the thread downwards around the thread take-up lever cover.

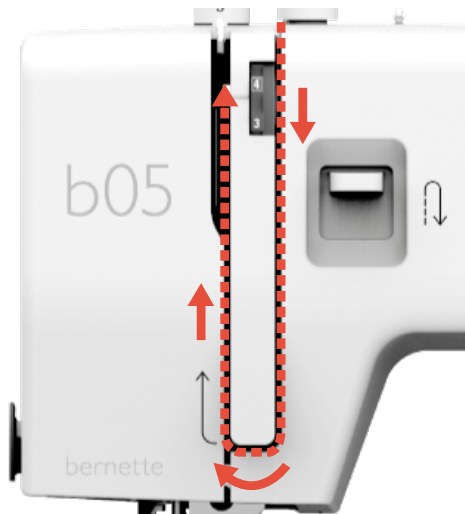

- > Guide the thread upwards from the right to the left through the thread take-up lever and then back downwards.

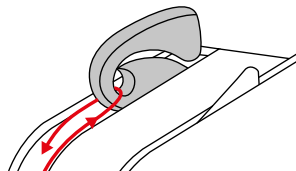

- > Guide the thread through the guides above the needle.

- > Lower the presser foot.

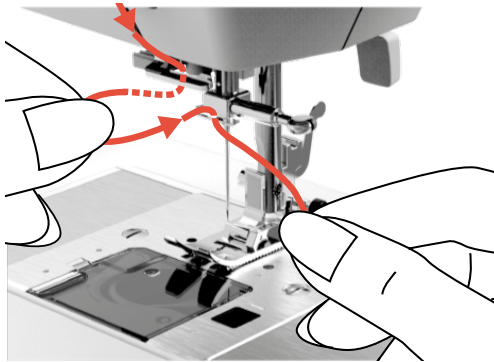

- > Press the needle-threading lever downwards slightly and guide the thread around the thread guide.

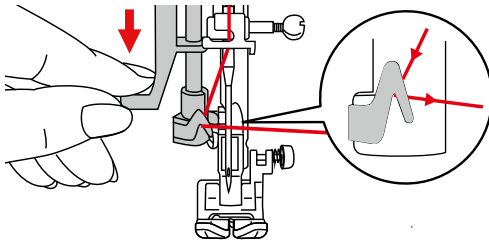

- > Push the needle-threading lever down as far as it will go and hold it down.
 - The wire hook moves through the needle eye.

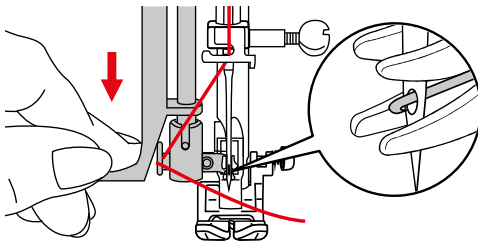

- > Guide the thread in front of the needle and underneath the wire hook and hold it.

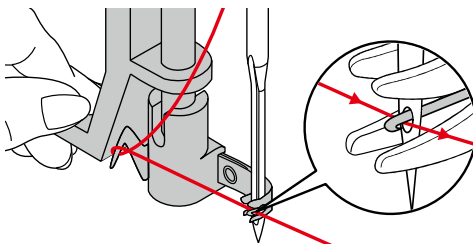

- > To thread the needle, lift the needle-threading lever. Keep the thread loose when doing so.
 - The wire hook moves backwards and pulls the thread through the needle eye into a loop.

- > Pull the thread all the way through the needle eye.

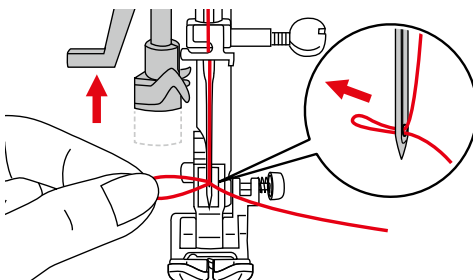

Threading the double needle

Prerequisite:

- The zigzag foot is fitted.
 - The twin needle is inserted.
 - The second spool pin, felt disc and second spool are fitted.
- > Guide the thread from the horizontal spool pin (red) in the direction of the arrow to the left side of the thread tension disc (1).

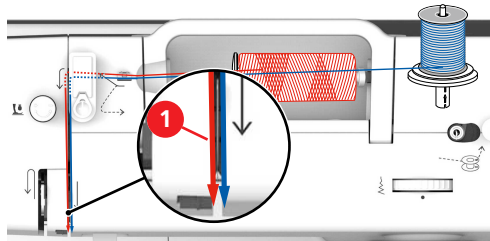

- > Guide the thread to the thread guide above the needle.
- > Thread the thread into the left needle manually.
- > Guide the thread from the vertical spool pin (blue) in the direction of the arrow to the right side of the thread tension disc (1).
- > Guide the thread to the thread guide above the needle.
- > Thread the thread into the right needle manually.

NOTICE

Needle breakage caused by incorrect presser foot, stitch or needle position

If the presser foot, stitch or needle position is incorrect, the needle can collide with the presser foot or stitch plate and break.

- > Fit the zigzag foot.
- > Set a straight stitch.
- > Set the needle to the center position.

Threading the Triple Needle

An external spool stand is required for the third spool when working with the triple needle.

Prerequisite:

- The zigzag foot is fitted.
 - The triple needle is inserted.
- > Place a spool with a felt disc and suitable spool disc on the horizontal spool pin.
- > Place the second spool with a felt disc on the vertical spool pin.
- > Place the third spool with a felt disc on the external spool stand.
- > Guide the thread from the horizontal spool pin (red) in the direction of the arrow to the left side of the thread tension disc (1).

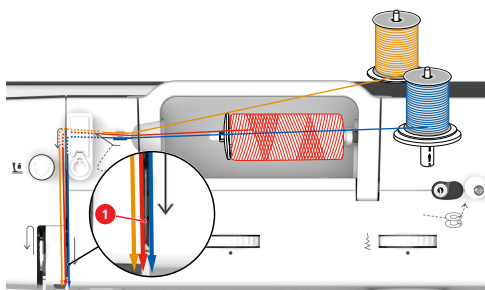

- > Guide the thread to the thread guide above the needle.
- > Thread the thread into the left needle manually.
- > Guide the thread from the external spool pin (orange) in the direction of the arrow to the left side of the thread tension disc (1).
- > Guide the thread to the thread guide above the needle.
- > Thread the thread into the center needle manually.
- > Guide the thread from the vertical spool pin (blue) in the direction of the arrow to the right side of the thread tension disc (1).
- > Guide the thread to the thread guide above the needle.
- > Thread the thread into the right needle manually.

NOTICE**Needle breakage caused by incorrect presser foot, stitch or needle position**

If the presser foot, stitch or needle position is incorrect, the needle can collide with the presser foot or stitch plate and break.

- > Fit the zigzag foot.
- > Set a straight stitch.
- > Set the needle to the center position.

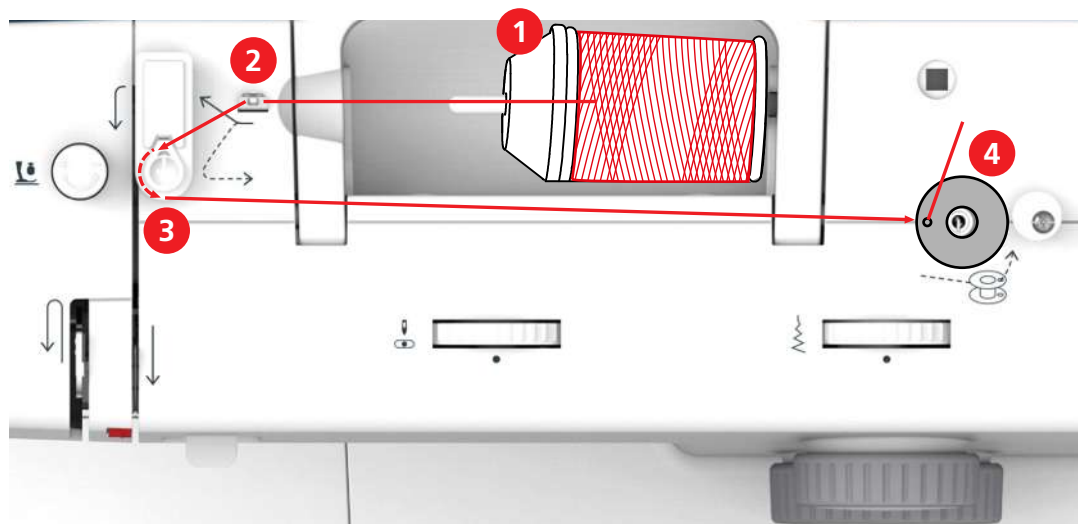
Winding the bobbin thread

- | | |
|----------------|-----------------------------|
| 1 Spool disc | 3 Bobbin winder pre-tension |
| 2 Thread guide | 4 Spool pin |

- > To prevent slippery threads from catching or breaking, pull the spool net over the spool.

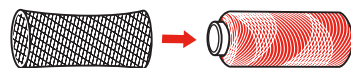

- > Place the thread spool and the appropriate spool disc on the spool holder. Use the small spool disc for smaller spools.

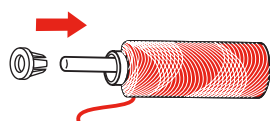

- > Guide the thread through the thread guide.

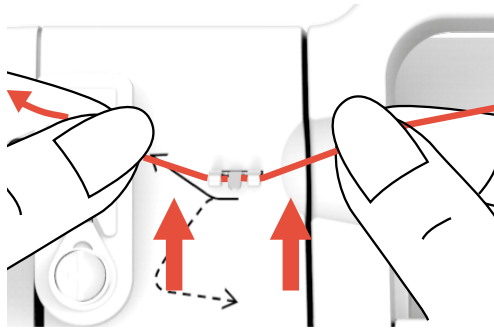

- > Guide the thread around the bobbin winder pre-tension in the direction of the arrow.

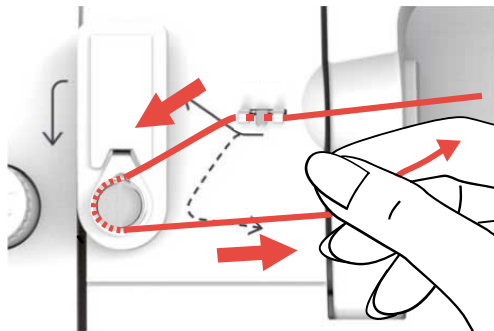

- > Pull the end of the thread through one of the inner holes on the bobbin and place the empty bobbin on the bobbin winding unit.

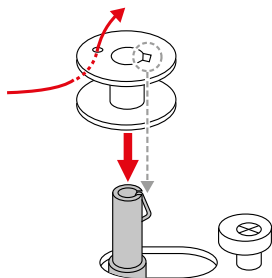

- > Push the bobbin to the right-hand position.

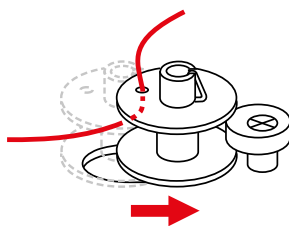

– The machine switches to bobbin winding mode. Sewing is not possible.

- > Hold the end of the thread tightly with one hand.

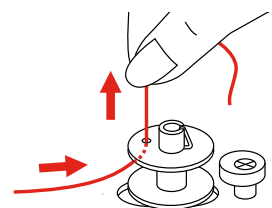

- > To start the winding process for a few rotations and then stop it again, press the foot control briefly so that the thread is firmly attached to the bobbin.

- > Cut the end of the thread above the inner hole.

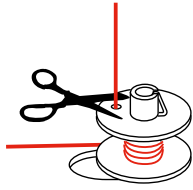

- > To continue the winding process, press the foot control.
- > Release the foot control to stop the winding process.
- > Push the bobbin winding unit to the left into the starting position.

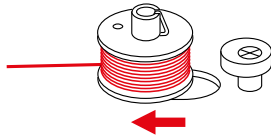

- The machine switches to sewing mode.

- > Remove the bobbin and cut the thread.

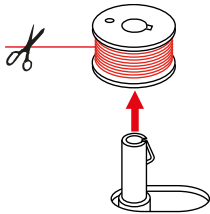

Threading the bobbin thread

NOTICE

Needle breakage caused by unevenly wound bobbins

Unevenly wound bobbins can lead to incorrect thread tension or cause needles to break.

- > Only use evenly wound bobbins.

Prerequisite:

- The needle is raised.
 - The presser foot is raised.
 - The machine is switched off.
- > To open the bobbin cover, push the handle to the right and remove the bobbin cover.

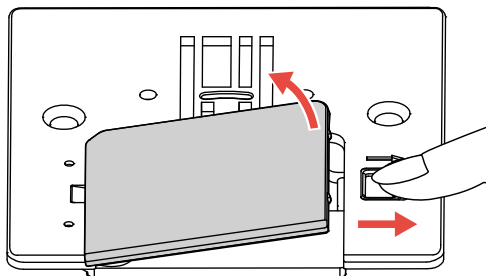

- > Insert a new bobbin so that the thread is wound anti-clockwise.

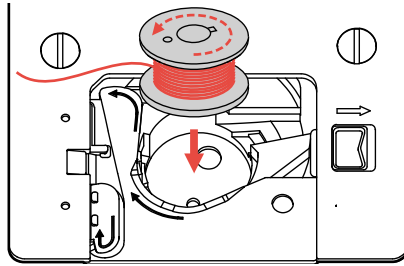

- > Press gently on the bobbin.
- > Follow the arrow markings to bring the thread into the bobbin thread guide.

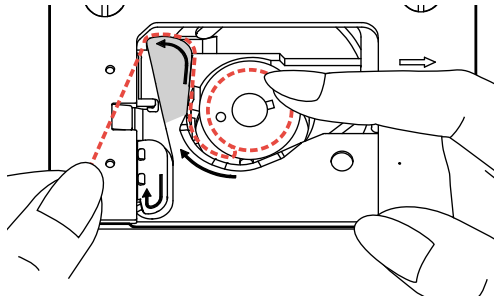

- > To cut off excess thread, take the end of the thread and pull it over the thread cutter (1).

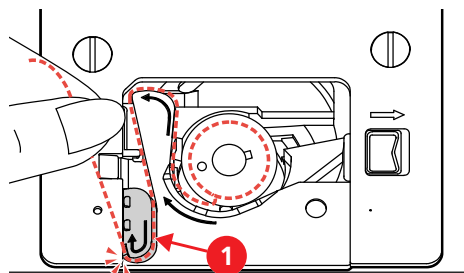

- > Attach the bobbin cover.

Pulling up the bobbin thread

- > Raise the presser foot and hold the needle thread gently in your left hand.

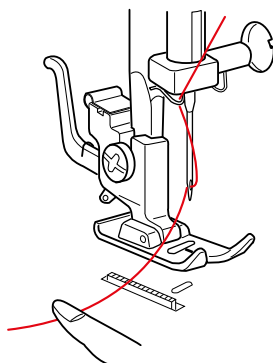

- > Turn the handwheel slowly anti-clockwise until the needle is lowered. Continue turning the handwheel until the thread take-up lever is at its highest point.

- > Pull the upper thread upwards until the bobbin thread forms a loop.

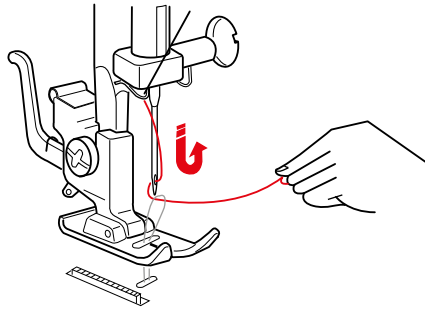

- > Pull the bobbin thread all the way to the top.
- > Pull 10 cm (4") of both threads back and under the presser foot.

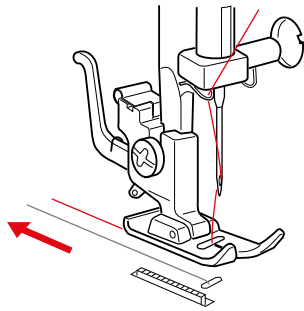

3 Creative sewing

3.1 Selecting a stitch pattern

The stitch patterns are divided into categories A to L. Each category can include up to three stitch patterns, which are indicated by the colors black, gray and red.

NOTICE

Incorrect needle position when selecting a stitch pattern

Damage to needle and fabric.

> Before turning the stitch pattern selector knob, move the needle to the topmost position.

> Raise the needle.

> To select the black stitch pattern in a category, set the stitch length knob to a value between 0 and 4, then turn the stitch pattern selector knob to the left or right until the chosen stitch pattern category engages in the center underneath setting position «•».



> To select the red stitch pattern in a category, set the stitch length knob to «S1», then turn the stitch pattern selector knob to the left or right until the chosen stitch pattern category engages in the center underneath setting position «•».



> To select the gray stitch pattern in a category, set the stitch length knob to «S2», then turn the stitch pattern selector knob to the left or right until the chosen stitch pattern category engages in the center underneath setting position «•».



3.2 Editing stitch patterns

Setting the stitch width

The stitch width can be varied from 0–6 mm for each stitch using the stitch width dial.



NOTICE

Incorrect needle position when selecting a stitch width

Damage to needle and fabric.

> Before turning the stitch width dial, move the needle to the topmost position.

> Raise the needle.

> Turn the stitch width dial until the required stitch width is shown above setting position «•».

Adjusting the stitch length

The stitch length can be adjusted using the stitch length knob.

For black stitch patterns, the stitch length can be set to 0–4 mm.

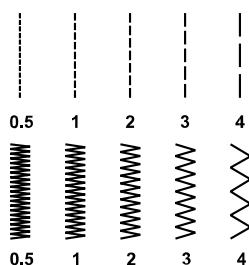

For buttonholes, the stitch length can be set within the range of the buttonhole symbol on the dial.

For red and gray stitch patterns, the stitch length is predefined and cannot be changed.

> Turn the stitch length knob until the required stitch length is shown underneath setting position «•».



Adjusting the upper thread tension

The upper thread tension must be adjusted depending on the sewing materials, the fabric layers and the sewing process using the «Upper thread tension» dial.

The base value for the upper thread tension is 4.



In perfect straight stitching, the bobbin thread is not visible on the right side of the fabric.

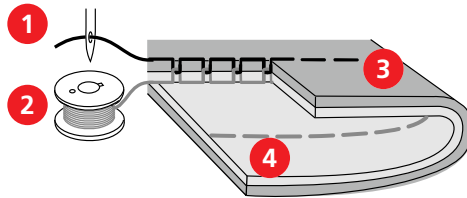

- | | | | |
|---|---------------|---|------------------------------------|
| 1 | Upper thread | 3 | Right side (top side) of fabric |
| 2 | Bobbin thread | 4 | Wrong side (bottom side) of fabric |

- > To increase the upper thread tension, set the «Upper thread tension» dial to a higher value.
- > To decrease the upper thread tension, set the «Upper thread tension» dial to a lower value.
- > If the bobbin thread is visible on the right side of the fabric, set the upper thread tension to a lower value.

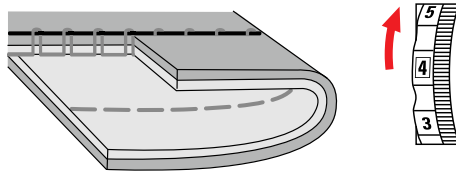

- > If the upper thread is visible on the wrong side of the fabric, set the upper thread tension to a higher value.

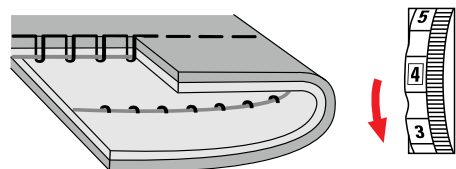

Adjusting the balance

Different fabrics, threads and linings can affect stretch stitch patterns or buttonholes, causing them to be sewn incorrectly. Mechanical balance adjustment enables these deviations to be corrected and the stitch pattern to be optimally adjusted for the fabric to be worked with.

- > Select a stretch stitch pattern or buttonhole.
- > Adjust the stitch length.
- > Adjust the stitch width.
- > Correct the balance by using a coin to turn it.

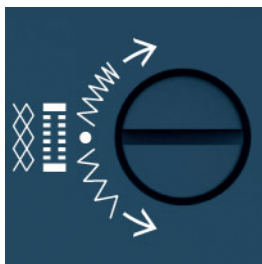

- > To increase the stitch density of the left satin stitch for the buttonhole, turn the balance adjustment knob clockwise.

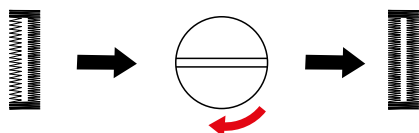

- > To decrease the stitch density of the left satin stitch for the buttonhole, turn the balance adjustment knob anti-clockwise.

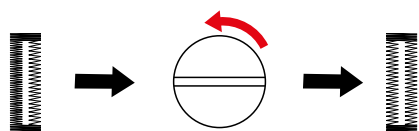

- > To increase the stitch density of the stretch stitches, turn the balance adjustment knob clockwise.

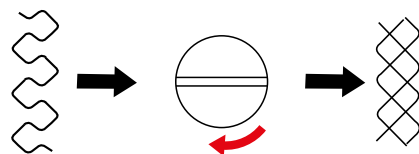

- > To decrease the stitch density of the stretch stitches, turn the balance adjustment knob anti-clockwise.

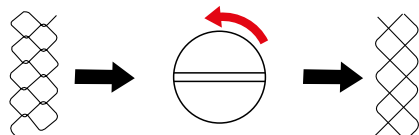

3.3 Quick reverse

Reverse sewing is used at the start and end of a seam to secure it.

- > Select the stitch pattern.
- > Press and hold the reverse sewing lever.

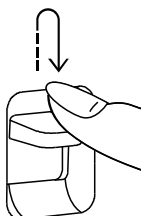

- > Press the foot control.
 - The machine stitches in reverse until the reverse sewing lever is released.

3.4 Securing

Securing the seam at the start

- > Select the stitch pattern.
- > Sew the seam forwards for a few stitches.
- > Press and hold the reverse sewing lever.
- > Sew backwards along the seam to the start of the seam.
- > Release the reverse sewing lever so that the machine starts sewing forwards.
 - The start of the seam is now secure.

Securing the seam at the end

- > Sew forwards using the selected stitch pattern to the end of the seam.
- > Press and hold the reverse sewing lever.
- > Sew the seam backwards for a few stitches.
- > Release the reverse sewing lever.

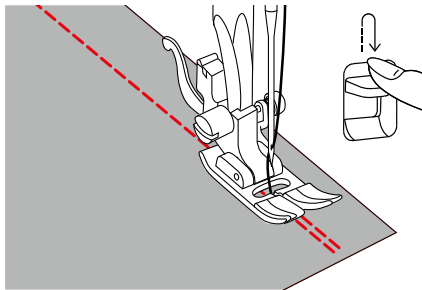

- > Sew along the seam again to the end of the seam.
 - The end of the seam is now secure.

3.5 Sew thick areas

- > Fit the zigzag foot.
 - The black knob on the right-hand side of the presser foot locks the presser foot in a horizontal position if it is pressed in before lowering the presser foot (1). This ensures even feeding at the beginning of a seam and helps when sewing multiple layers of fabric such as sewing over seams when hemming jeans.
- > Once the highest point has been reached, lower the needle and raise the presser foot.
- > Press the foot tip and the black knob, lower the presser foot and continue sewing.
 - The black button releases automatically after sewing few stitches.

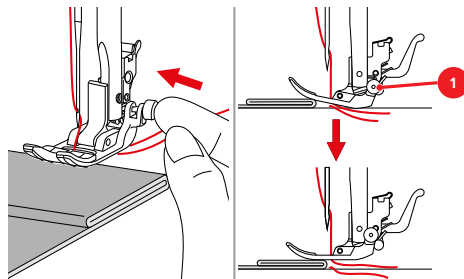

- > To support the presser foot when manually guiding the fabric and sewing from the folded side, place one, two or three small plates from the height compensating tool (1) behind the needle under the presser foot.

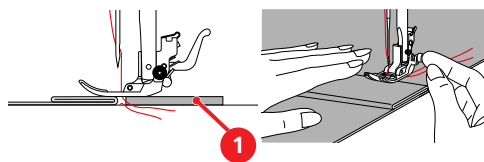

1 Height compensating tool

3.6 Sewing Corners

- > Stop the machine when the corner is reached.
- > Pierce the needle into the fabric.
- > Raise the presser foot.

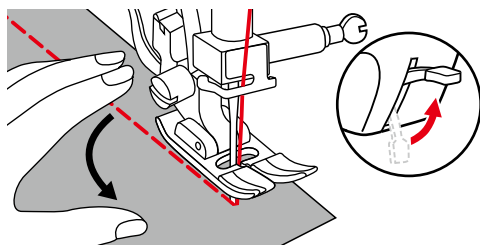

- > Use the needle as a pivot and turn the fabric.
- > Lower the presser foot and continue sewing.

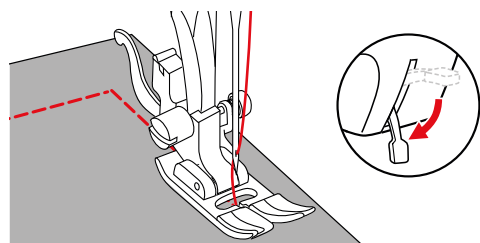

3.7 Sewing very slippery fabrics





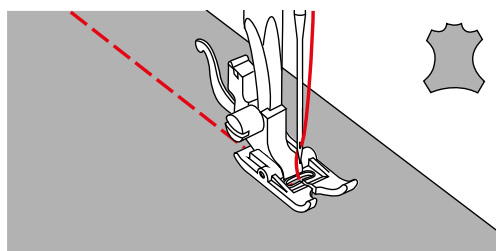





Very slippery materials such as leather, imitation leather, plastic or vinyl can easily be sewn using the zigzag foot with sliding sole.







- > Fit the zigzag foot with sliding sole.
- > Select the required stitch pattern.
- > Select the required stitch length.
- > Select the required stitch width.
- > Set the required needle position.
- > Sew at a slow, even speed.



4 Practical stitches

4.1 Overview Practical stitches

Stitch pattern	Stitch category	Name	Description	Recommended presser foot	Stitch length	Stitch width
	A	Straight stitch	For sewing material together and top-stitching.	Zigzag foot	0,5 – 4,0	0
	B	Zigzag	For reinforcing seams, finishing edges, sewing elastic seams and attaching lace inserts.	Zigzag foot	0,5 – 4,0	2,0 – 6,0
	C	Sewn-out Zig zag	For finishing and reinforcing fabric edges and attaching rubber tape. For decorative seams.	Zigzag foot	2,0 – 3,0	2,5 – 5,0
	D	Vari-Overlock stitch	For simultaneously sewing together and finishing elastic fabrics.	Zigzag foot	2,0 – 3,0	6,0
	E	Elastic blindstitch	For blind hems and decorative seams.	Blindstitch foot	1,0 – 2,0	3,0 – 5,0
	F	Universal stitch	For firm fabrics such as felt and leather. For flat joining seams, visible hems and decorative seams. For attaching rubber tape.	Zigzag foot	1,5 – 3,0	3,0 – 5,0
	G	Lycra stitch	For flat joining seams or visible hems on Lycra fabric. For stitching over seams on corsetry.	Zigzag foot	1,5 – 3,0	6,0
	H	Shell edging stitch	For blind hems, shell edging effect on soft jerseys and fine fabric. For decorative seams.	Zigzag foot	1,0 – 2,5	3,0 – 6,0
	I	Gathering stitch	For most types of fabric. For gathering rubber threads. For sewing edges of fabric that meet. For decorative seams.	Zigzag foot	2,0 – 3,0	3,0 – 5,0
	J	Blind stitch	For blind hems and decorative seams.	Blindstitch foot	1,0 – 2,0	1,0 – 2,5
	L	Super-stretch stitch	For highly stretch fabrics. For all types of clothing.	Zigzag foot	1 – 2,5	3,0 – 4,0

Stitch pattern	Stitch category	Name	Description	Recommended presser foot	Stitch length	Stitch width
	A	Triple Straight stitch	For durable seams in strong fabrics. For visible hems and seams.	Zigzag foot	S1	0
	B	Triple Zig zag	For durable seams in strong fabrics. For visible hems and seams.	Zigzag foot	S1	2,0 – 6,0
	C	Honeycomb stitch	For sewing elastic fabrics and hems, including with rubber bobbin threads.	Zigzag foot or open embroidery foot	S1	6,0
	D	Knit overlock	For sewing together and finishing hand- and machine-knitted fabrics in one step.	Zigzag foot	S1	6,0
	F	Double overlock	For simultaneously sewing together and finishing elastic fabrics.	Zigzag foot	S1	6,0
	H	Stretch overlock	For simultaneously sewing together and finishing elastic fabrics. For flat joining seams.	Zigzag foot	S1	6,0
	J	Reinforced overlock	Medium-weight knits and toweling. For overlock seams or flat joining seams.	Zigzag foot or overlock foot	S1	6,0

4.2 Sewing straight stitch



Adjust the stitch length for the sewing project, e.g. a long stitch for denim (approx. 3–4 mm) and a short stitch for delicate fabric (approx. 2–2.5 mm). Adjust the stitch length depending on the thread thickness, e.g. a long stitch (approx. 3–4 mm) for top-stitching with gimp.

- > Fit the zigzag foot.
- > Set the stitch pattern selector knob to position «A».
- > Set the required stitch length.
- > Set the stitch width to «0».
- > Adjust the needle position.

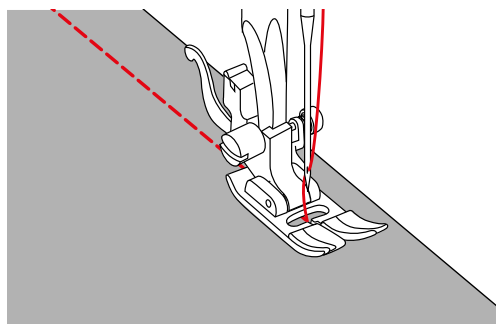

4.3 Sewing in the zipper



As the fabric feed can be difficult when starting to sew, it is recommended to hold the threads firmly or to pull the fabric slightly to the back for a few stitches or to sew 1 – 2 cm reverse first.

- > Finish the seam allowances individually.
- > Fit the zigzag foot.
- > Set the stitch pattern selector knob to position «A».
- > Set the required stitch length.
- > Set the stitch width to «0».
- > Set the needle position to «Center».
- > Close and sew the seam up to where the zipper starts.
- > Set the stitch length to 4.
- > Tack the zipper length with long stitches.
- > Iron the seam apart.
- > Unpick the tacking stitches.
- > Tack the zipper under the fabric so that the fabric edges meet over the center of the zipper.

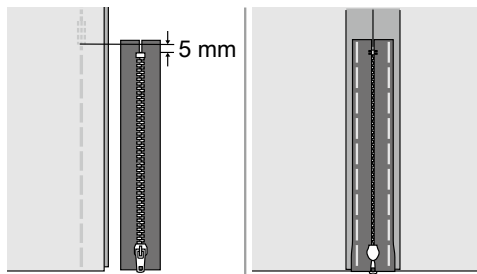

- > Fit the zipper foot.
- > When sewing the left-hand side of the zipper, secure the right-hand side of the presser foot pin using the holder.

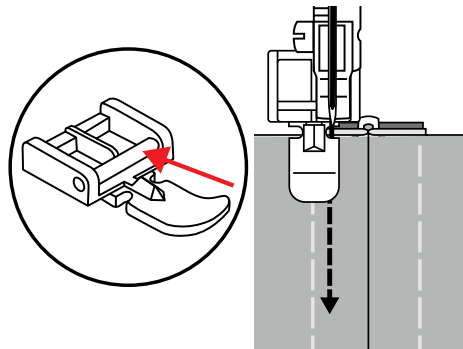

- > When sewing the right-hand side of the zipper, secure the left-hand side of the presser foot pin using the holder.

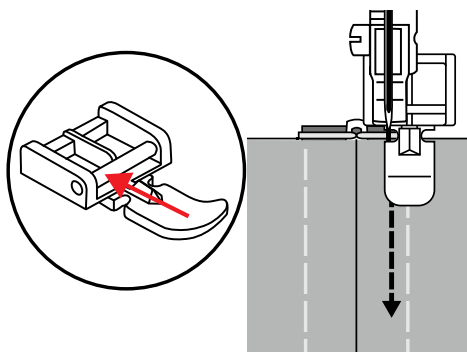

- > Sew the left-hand side of the open zipper from top to bottom.
- > Close the zipper up to approx. 5 cm from the end.
- > Sew over the lower end and the right-hand side of the zipper.
- > Stop before the zipper slider.
- > Move the needle into the lower position.
- > Raise the presser foot.
- > Open the zipper.
- > Finish sewing the right side.
- > Remove the tacked seam.

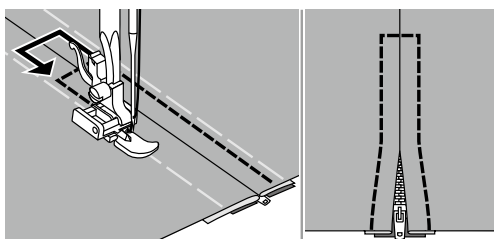

4.4 Stitching in a concealed zipper

Concealed zippers are a particularly elegant solution for clothing and are very practical when used on bags and home furnishings. As these special zippers are hidden by the seam after being sewn in, they form an almost invisible closure.



As the fabric feed can be difficult when starting to sew, it is recommended to hold the threads firmly or to pull the fabric slightly to the back for a few stitches or to sew 1 – 2 cm reverse first.

- > Open the zipper completely.
- > Pin the right-hand half of the zipper with its right side against the right side of the right-hand fabric. The spiral points away from the edge of the fabric.
- > Fit the zipper foot for concealed zippers.
- > Set the stitch pattern selector knob to position «A».
- > Set the required stitch length.
- > Set the stitch width to «0».
- > Set the needle position to «Center».

- > Lower the presser foot at the start of the zipper so that the spiral is guided through the right presser foot groove.

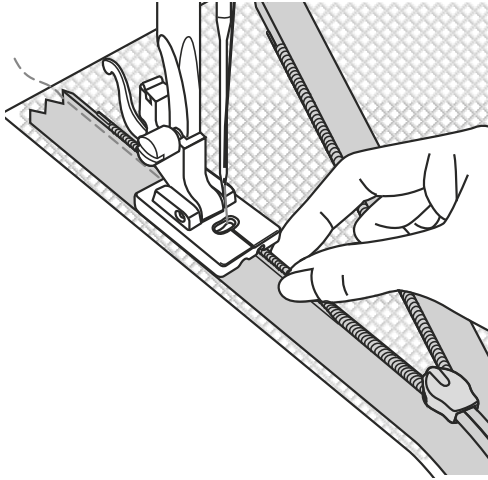

- > Sew and close the right-hand half of the zipper from top to bottom up to the slider.
- > Close zipper.
- > Pin the left-hand half of the zipper with its right side against the right side of the left-hand fabric. The spiral points away from the edge of the fabric.
- > Open the zipper completely.
- > Lower the presser foot at the start of the zipper so that the spiral is guided through the left presser foot groove.

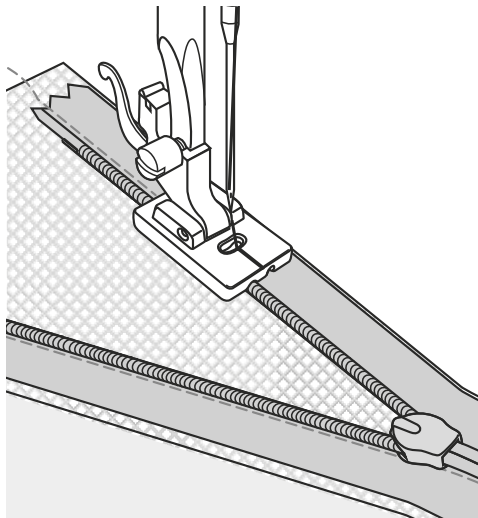

- > Sew and close the left-hand half of the zipper from top to bottom up to the slider.
- > Remove the sewing material from the machine.
- > Close zipper.
- > Place the two right sides of the fabric against each other. Fold the ends of the zipper outwards as far as it would go.

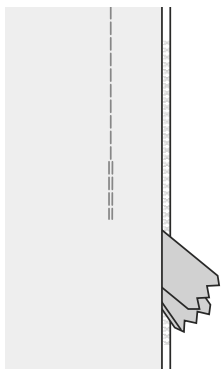

- > Pin the ends of the zipper seams precisely on top of one another.
- > Pin the seam together from the bottom to the zipper.
- > Fit the zigzag foot.
- > Close and sew the seam from the bottom to the zipper.

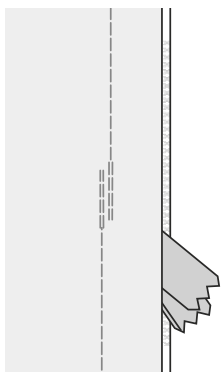

4.5 Sewing Triple straight stitch

The triple straight stitch is especially suitable for durable seams and for firm, densely woven fabrics such as denim and corduroy.

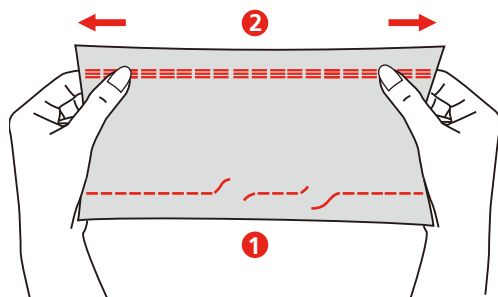

1 Straight stitch

2 Triple Straight stitch

- > Fit the zigzag foot.
- > Set the stitch length knob to «S1».
- > Set the stitch pattern selector knob to «A».

4.6 Sewing Triple zigzag

The triple zigzag is particularly suitable for firm fabrics, especially denim, deckchair fabric and awnings, and for hems on fabrics that are washed often.

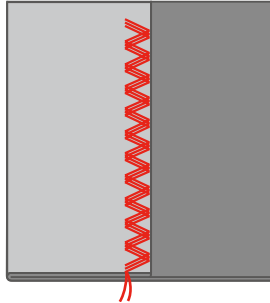

Prerequisite:

- Finish the seam edges first.
- > Fit the zigzag foot.
- > Set the stitch length selector knob to «S1».
- > Turn the stitch selector knob to category «B».
- > Set the required stitch width.

4.7 Super-stretch

The super-stretch stitch is a narrow stretch stitch designed to eliminate puckering on knit fabrics and bias seams, while permitting the seam to be pressed completely open flat.

- > Fit the zigzag foot.
- > Set the stitch pattern selector knob to «L».
- > Set the stitch length and stitch width according to the stitch table.
- > Sew the seam at the required distance from the fabric edge without stretching the fabric.

4.8 Sewn-out Zig zag

The sewn zigzag is used to finish seams on synthetics and other fabrics that tend to pucker. The stitch is also excellent for darning and mending tears, as well as for attaching elastic tape.

- > Fit the zigzag foot.
- > Set the stitch pattern selector knob to «C».
- > Set the stitch length and stitch width according to the stitch table.

For finishing:

- > Position the fabric so that the stitch is sewn at a distance of 1.5 cm from the edge of the fabric.
- > Sew the seam.
- > Trim the seam allowance after sewing. Be careful not to cut the stitches.

For sewing on elastic tape:

- > Pin the elastic tape to the left-hand side of the fabric. When doing so, stretch the tape and ensure that it is positioned evenly on the fabric.

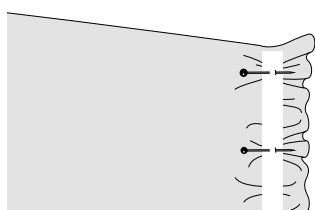

- > To attach the elastic tape, pull it apart along the length of the gathered fabric.

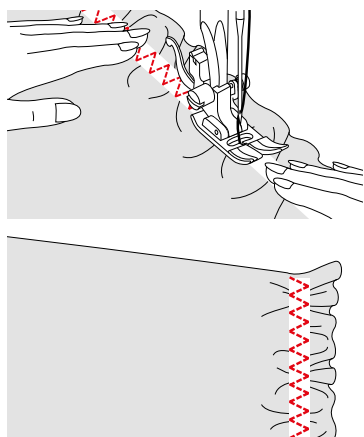

4.9 Manual darning

Used for darning holes or worn areas in all fabric types.

- > Remove the presser foot holder and fit the darning/embroidery foot on the presser foot bar.
 - The lever (1) must rest on the top of the needle clamping screw (2).
- > Press the darning/embroidery foot from underneath with your finger and tighten the screw (3).

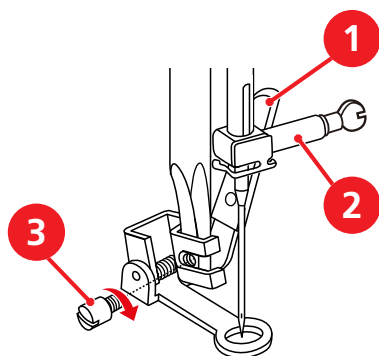

- > Turn the stitch pattern selector knob to «A».
- > Set the stitch length to «0».
- > Lower the feed dog.
- > Attach the extension table.
- > Lower the feed dog.

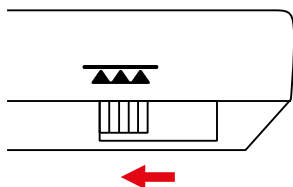

- > Tension the sewing project in a darning hoop.
 - The darning area stays evenly taut and cannot be distorted.

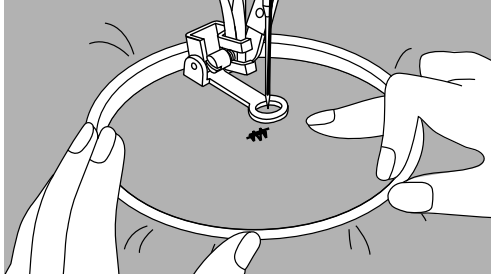

- > Turn the handwheel anti-clockwise to bring up the bobbin thread.
- > Sew a few stitches at the start of the seam.
- > Sew from the left to the right, guide the fabric evenly by hand without using pressure.
- > If the thread is lying on the top, continue sewing at a slower pace.
- > If knots form on the wrong side of the fabric, sew faster.
- > If the thread breaks, continue sewing at a more even pace.
- > Move in curves when changing the direction to avoid holes and thread breakage.

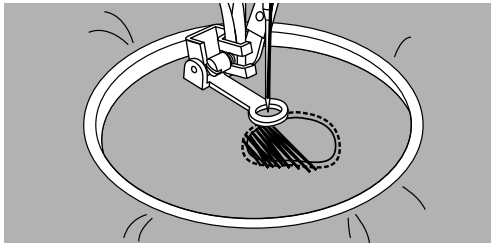

- > After you have finished darning, raise the presser foot and restart the feed dog.

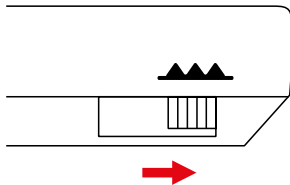

4.10 Finishing edges

The zigzag stitch is suitable for finishing all types of fabric. Use darning thread for fine materials.

Prerequisite:

- The edge of the fabric should lie flat and not roll.
- > Fit the zigzag foot or overlock foot.
- > Do not set the stitch length too long.
- > Set the stitch pattern selector knob to «B».
- > Do not set the stitch width too wide.

- > Guide the edge of the fabric into the center of the zigzag foot so that the needle goes into the fabric on one side and over the edge into the air on the other side.

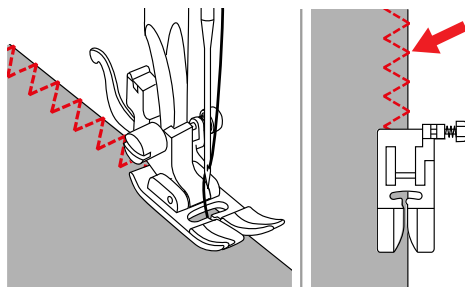

- > Guide the edge of the fabric along the guide plate on the overlock foot (1) so that the needle goes into the fabric on one side and over the edge into the air on the other side.

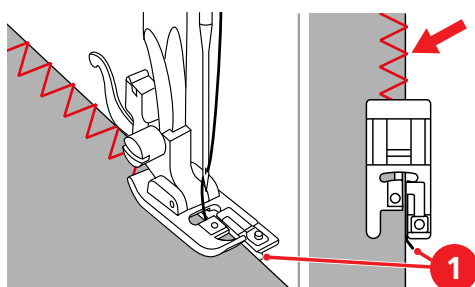

4.11 Sewing Double overlock

A double overlock seam is suitable for looser knit fabric and for cross seams in woven fabric. A new jersey or stretch needle must be used for knit fabrics so that the delicate knit is not damaged.

- > Fit the zigzag foot or overlock foot.
- > Set the stitch pattern selector knob to «F».
- > Set the stitch length knob to «S1».
- > Set the stitch width according to the stitch table.
- > For finishing the edge of the fabric with the zigzag foot: Position the edge of the fabric under the presser foot so that the right-hand straight stitch is sewn close to the edge of the fabric.

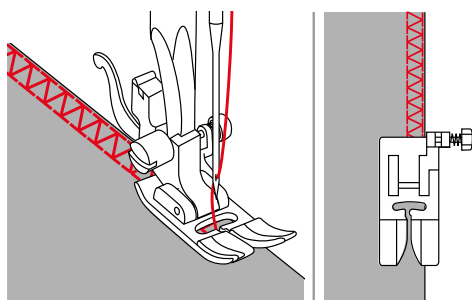

- > For sewing and hemming elastic fabrics and for sewing belt loops: Fold the edge of the fabric backwards with the left-hand sides together. Sew the seam on the right-hand side of the fabric. Cut off any excess fabric from the edge of the fabric up to the seam.

4.12 Sewing Vari overlock

- > Fit the overlock foot.
- > Set the stitch pattern selector knob to «D».
- > Set the stitch length and stitch width according to the stitch table.

- > Sew the fabric with the edge of the fabric against the overlock foot guide.

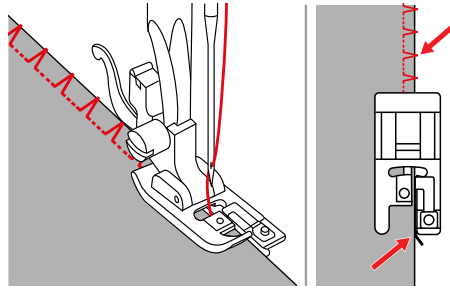

4.13 Narrow edgestitching

- > Fit the blind stitch foot, edge stitch foot or zigzag foot.
- > Set the stitch pattern selector knob to «A».
- > Set the required stitch length.
- > Set the stitch width to «0».

Using the blind stitch foot or edge stitch foot:

- > Place the left-hand edge of the fabric against the guide of the blind stitch foot or edge stitch foot.
- > Set the left-hand needle position.

Using the zigzag foot:

- > Guide the edge of the fabric along the right-hand edge of the presser foot or the markings on the stitch plate.
- > Adjust the needle position to the right.

4.14 Wide edgestitching

- > Fit the blind stitch foot, edge stitch foot or zigzag foot.
- > Set the stitch pattern selector knob to «A».
- > Set the required stitch length.
- > Set the stitch width to «0».

Using the zigzag foot:

- > Guide the edge of the fabric along either the right-hand edge of the presser foot or the markings on the stitch plate.

The markings on the stitch plate indicate the distance between the center needle position and the guideline.

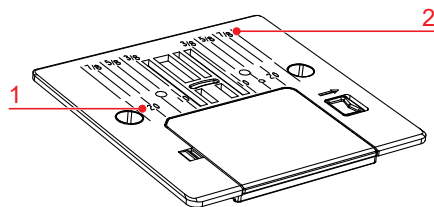

1 Distance in mm

2 Distance in inches

Using the blind stitch foot or edge stitch foot:

- > Place the left-hand edge of the fabric against the guide of the blind stitch foot or edge stitch foot.
- > Select the left-hand needle position at the desired distance to the edge.

4.15 Edgestitching using the seam guide

When sewing parallel wide top-stitching lines, we recommend guiding the seam guide along a sewn line.

- > Attach the seam guide to the zigzag foot.
- > Fit the zigzag foot.
- > Set the stitch pattern selector knob to «A».
- > Set the required stitch length.
- > Set the stitch width to «0».
- > To adjust the distance, move the seam guide to the left or right.

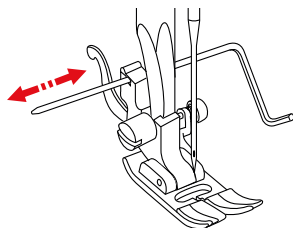

- > Sew the first row.
- > Sew the following rows while guiding the seam guide along the previous seam.

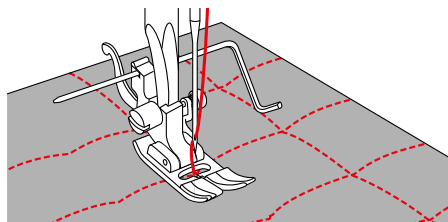

4.16 Sewing hem edges

When using the blind stitch foot, we recommend setting the needle position all the way to the left or right. When using the zigzag foot or edge stitch foot, all needle positions are possible.

- > Fit the blind stitch foot, edge stitch foot or zigzag foot.
- > Set the stitch pattern selector knob to «A».
- > Set the required stitch length.
- > Set the stitch width to «0».
- > To sew on the top edge of the seam, select the right-hand needle position.
- > Place the inside upper edge of the seam on the right-hand side against the guide on the blind stitch foot or edge stitch foot.

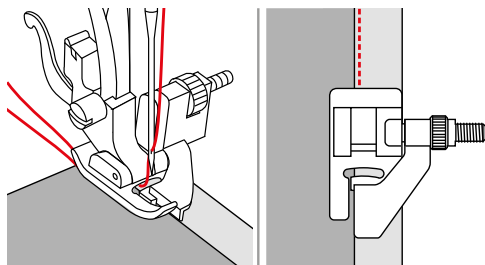

4.17 Sewing a narrow hem

- > Fit the hemmer foot.
- > Turn the stitch pattern selector knob to «A».
- > Set the required stitch length.
- > Set the stitch width to «0».

- > Fold the edge of the fabric about 3 mm and turn it over again. Fold the first 5 cm of the fabric edge to be sewn.

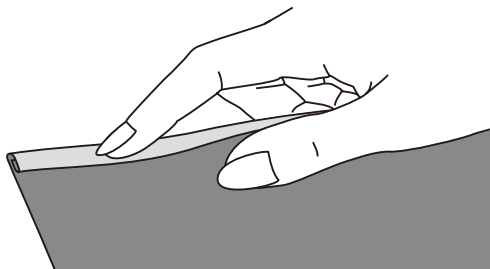

- > Place the edge of the fabric with the left-hand side of the fabric facing up under the presser foot. The fabric under the presser foot should be just less than the width of the presser foot.
- > Sew 4–5 stitches.
- > Raise the needle and presser foot.
- > Pull the fabric backwards by about 10–15 cm. Do not cut the thread.
- > Hold the 4 threads in your left hand. Pull the edge of the fabric into the spiral guide on the hemmer foot using your right hand.

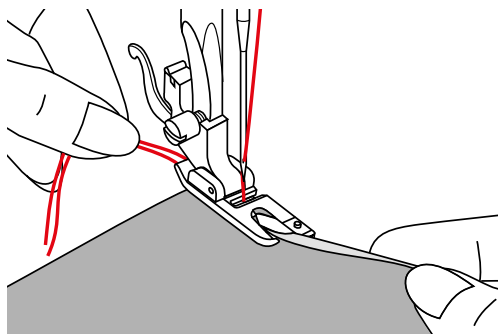

- > Lower the presser foot.
- > Continue sewing slowly while slightly folding the cut edge of the fabric in front of the hemmer foot and holding it to the left. Guide the edge of the fabric evenly into the spiral guide on the hemmer foot and sew.

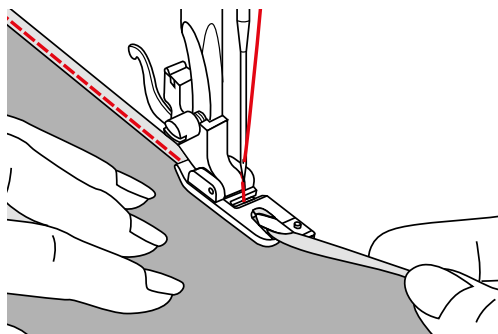

4.18 Sewing blind hems

For invisible hems in medium to heavy weight cotton, wool and blended materials.

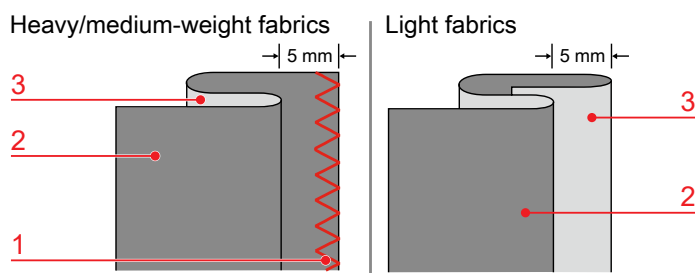

- | | | | |
|---|-----------------------|---|------------------------|
| 1 | Finishing seam | 3 | Right-hand fabric side |
| 2 | Left-hand fabric side | | |

A blind stitch «J» is suitable for sewing firm fabrics. The elastic blind stitch «E» is suitable for elastic fabrics.

Prerequisite:

- The edges of heavy and medium-weight fabrics are finished.
- > Fit the blind stitch foot.
- > Set the stitch pattern selector knob to «E» or «J».
- > Set the required stitch length.
- > Set the required stitch width.
- > Fold the fabric as illustrated with the wrong side up.
- > Place the fabric beneath the presser foot.
- > Turn the handwheel anti-clockwise until the needle is all the way to the left. The needle should just pierce the fold in the fabric (3). If it does not, adjust the stitch width accordingly.
- > Adjust the guide (2) by turning the dial (1) so that the guide is positioned directly against the fold.

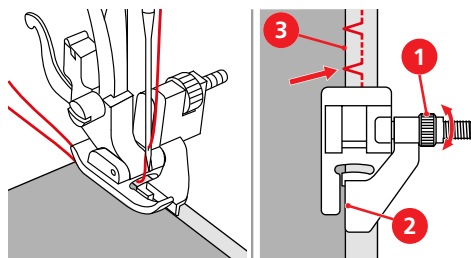

- > Sew slowly while guiding the fabric carefully along the edge of the guide.

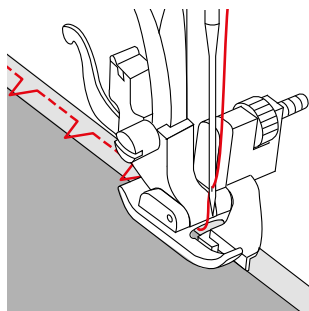

- > Turn over the fabric.

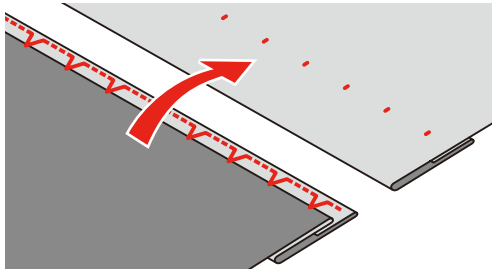

4.19 Sewing visible hems

The visible hem is especially suitable for elastic hems in tricot fabric made of cotton, wool, synthetics and blended fibers.

We recommend using the Lycra stitch or triple zigzag as a visible hem stitch for elastic fabrics.

We recommend using the universal stitch or triple straight stitch as a visible hem for non-elastic fabrics.

- > Fit the zigzag foot or upper feed foot.
- > Set the stitch pattern selector knob to the required stitch.
- > Adjust the stitch length according to the stitch table.
- > If required, adjust the presser foot pressure.
- > Iron the hem and baste if necessary.
- > Sew the hem at the required depth on the right side.
- > Cut off the remaining fabric on the wrong side.

4.20 Sewing flat joining seams

The flat joining seam is particularly suitable for fleecy or thick fabrics such as terry, felt or leather. Suitable stitches are the reinforced overlock stitch, the universal stitch, the Lycra stitch and the stretch overlock stitch.

- > Fit the zigzag foot.
- > Set the stitch pattern selector knob to «H».
- > Set the stitch length knob to «S1».
- > Set the required stitch width.
- > Overlap the fabric edges.
- > Sew along the fabric edge. The needle stitches over the edge of the top layer on the right side into the bottom layer to get a very flat durable seam.

4.21 Sewing basting stitches

When sewing basting stitches, it is recommended to use a fine darning thread. This is easier to remove. The recommended stitch length is 3.5–4 mm. The tacking stitch is suitable for tacking multiple layers of fabric.

- > Fit the zigzag foot.
- > Set the stitch pattern selector knob to «A».
- > Set the stitch length to «4».
- > Set the stitch width to «0».
- > Pin the fabric layers at a right angle to basting direction to prevent the layers from slipping.

5 Decorative stitches











5.1 Overview Decorative Stitches

Easier or more difficult decorative stitches come into their own depending on the type of fabric.

Decorative stitches that consist of simple straight stitches are particularly attractive on lightweight fabrics.

Decorative stitches made up of satin stitches look especially stylish on heavy fabrics.

For a perfect stitch formation it is of advantage to use the same thread color for upper and bobbin thread and a stabilizer. With pile or longfiber materials, it is recommended to use an additional, water-soluble stabilizer on the right side, which can be easily removed after sewing.

Stitch pattern	Stitch category	Name	Description	Recommended presser foot	Stitch length	Stitch width
	K	Satin stitch	For decorative effects. For embellishing and decorating medium-weight to heavy fabrics.	Zigzag foot	0,5 – 1,0	6,0
	D	Vari-Overlock stitch	For a shell edging effect on soft jerseys and fine fabric.	Zigzag foot	2,0 – 3,0	6,0
	C	Honeycomb stitch	For decorative effects. For smocking.	Zigzag foot	S1	3,0 – 6,0
	E	Florentine stitch	Decorative elastic stitch. For decorating knitted or woven fabrics. Also ideal for crazy quilting.	Zigzag foot	S1	6,0
	F	Double overlock	For stitching two fabrics together to create a breakthrough look.	Zigzag foot	S1	6,0
	G	Faggot stitch	For stitching two fabrics together to create a breakthrough look. For smocking.	Zigzag foot	S1	3,0 – 6,0
	K	Decorative stitch	For decorative effects.	Zigzag foot	S1	6,0
	B	Decorative stitch	For decorative effects.	Zigzag foot	S2	6,0
	C	Decorative stitch	For white embroidery and decorative effects.	Zigzag foot	S2	6,0
	E	Decorative stitch	For decorative effects.	Zigzag foot	S2	6,0
	G	Decorative stitch	For decorative effects.	Zigzag foot	S2	6,0

Stitch pattern	Stitch category	Name	Description	Recommended presser foot	Stitch length	Stitch width
50474	K	Decorative stitch	For decorative effects.	Zigzag foot	S2	6,0

5.2 Altering the stitch density

When using the satin stitch, the stitch density can be adjusted by changing the stitch length. A short stitch length means that the distance between stitches is shorter and the stitch is denser. A longer stitch length means that the distance between stitches is greater and the stitch is less dense.

- > Set the stitch selector to «K».
- > Adjust the stitch length.
- > Adjusting the stitch length changes the stitch density.

5.3 Gathering stitches

Gathering

Ideal for delicate and medium-weight fabrics. For decorating clothing or decorative items.

- > Fit the zigzag foot.
- > Set the stitch pattern selector knob to position «A».
- > Set the stitch width to «0».
- > Set the stitch length to «4».
- > Set the needle position to «Center».
- > Set the thread tension to «2» or less.
- > Pull out around 5 cm of the upper thread and bobbin thread.
- > Sew along the fabric edge at a distance the same as the width of the foot. At the start, make a few reverse stitches to sew it up. Leave the protruding ends of the thread around 10–12 cm long.
- > Sew additional lines at a distance of approx. 5 mm. At the start, make a few reverse stitches to sew it up. Leave the protruding ends of the thread around 10–12 cm long.
- > Pull the bobbin threads and distribute the folds evenly.

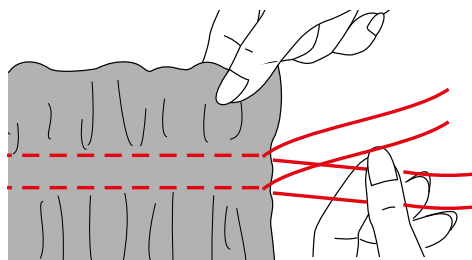

Smocking

Decorative stitches that are sewn over ruffles are referred to as smocking. This technique is used to decorate blouses or cuffs, among other purposes. Smocking gives fabric texture and elasticity. The following stitches are suitable for smocking:

- Honeycomb stitch (S1, C)
- Faggot stitch (S1, G)
- > Fit the zigzag foot.
- > Set the stitch pattern selector knob to position «A».
- > Set the stitch length to «4».
- > Set the thread tension to «2» or less.
- > Sew a tacking stitch 1 cm away.

- > Tie the threads in a knot on one side.
- > On the other side, pull the bobbin threads and distribute the folds evenly.
- > Secure the threads.
- > Select the honeycomb stitch or faggot stitch.
- > Set the stitch width to «6».
- > Set the thread tension to «4».
- > Sew decorative stitches between the gathering seams.

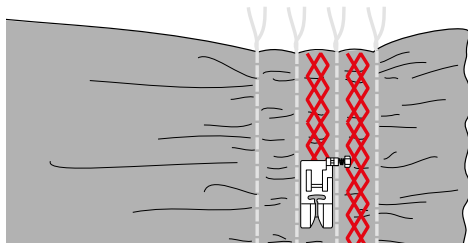

- > Remove the tacking threads.

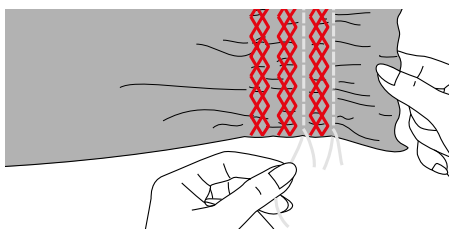

5.4 Connecting stitches

Joining seam with faggot stitch

The faggot stitch can be used to sew two fabric edges together at a distance. This stitch pattern is used to decorate blouses and children's clothing. The decorative effect of this stitch pattern is more striking if thicker thread is used.

- > Fit the zigzag foot.
- > Set the stitch pattern selector knob to position «G».
- > Set the stitch length knob to «S1».
- > Set the stitch width to «6».
- > Tack the folded edges of two pieces of fabric to a piece of washable lining with a gap of 4 mm.

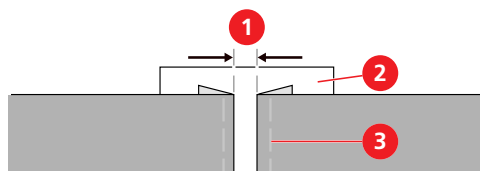

- 1 4 mm gap
- 2 Washable lining

- 3 Tacking thread

- > Lower the presser foot centrally between the edges of the fabric and sew.

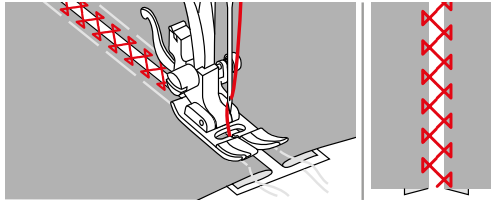

- > After sewing, remove the lining and tacking thread.

Joining seam with double overlock stitch

The double overlock stitch can be used to sew two fabric edges together at a distance. This stitch pattern is used to decorate blouses and children's clothing. The decorative effect of this stitch pattern is more striking if thicker thread is used.

- > Fit the zigzag foot.
- > Set the stitch pattern selector knob to position «F».
- > Set the stitch length knob to «S1».
- > Set the stitch width to «6».
- > Tack the folded edges of two pieces of fabric to a piece of washable lining with a gap of 4 mm.

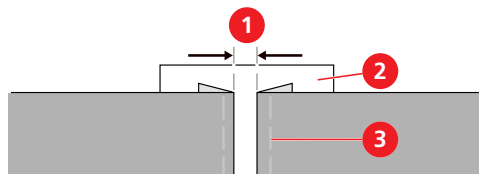

- 1 4 mm gap
- 2 Washable lining
- 3 Tacking thread

- > Lower the presser foot centrally between the edges of the fabric and sew.

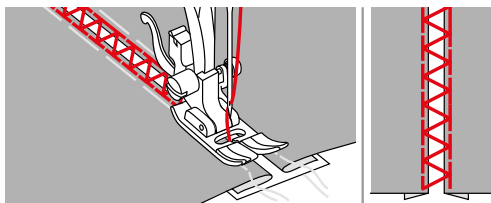

- > After sewing, remove the lining and tacking thread.

5.5 Edging

Shell edging with Vari-overlock stitch

The Vari-overlock stitch can be used to create a shell edging effect on soft jerseys and fine fabric.



- > Fit the zigzag foot.

- > Set the stitch pattern selector knob to «H».
- > Set the required stitch length.
- > Set the required stitch width.
- > Fold the edge of the fabric in by about 5 mm. Position the fabric under the presser foot so that the needle goes into the air just past the edge of the fabric on the right-hand side.

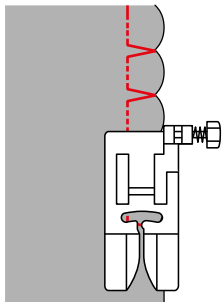

Shell edging with satin stitch

A wavy hem with satin stitches can be used to decorate blouse necklines and the edges of knitted fabrics.

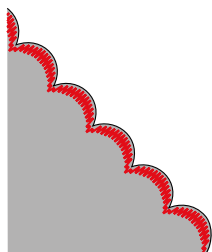

- > Fit the zigzag foot.
- > Turn the stitch pattern selector knob to position «K».
- > Select the required stitch length.
- > Set the required stitch width.
- > Set the needle position to «Center».
- > Sew along the edge of the fabric at a distance of approx. 1 cm.
- > Use scissors to cut the fabric carefully along the seam.

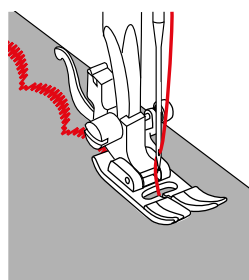

6 Buttonholes

6.1 Overview Buttonholes

To automatically sew buttonholes, the machine features a single-step buttonhole program. The corresponding button can be sewn on automatically.

Stitch pattern	Stitch category	Name	Description	Recommended presser foot	Stitch length	Stitch width
	–	Single-step buttonhole stitch	For light to medium-weight fabrics; blouses, dresses, bedlinen.	Buttonhole foot	0,3 – 0,5	4,0 – 6,0

6.2 Marking buttonholes

- > Mark the positions of the buttonholes on the fabric.

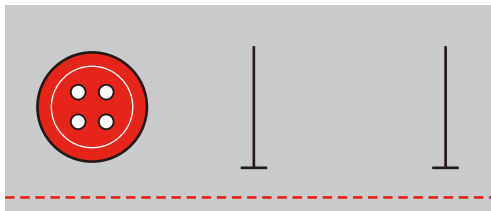

6.3 Determining the buttonhole length

The buttonhole size is automatically determined by placing a button in the foot. The maximum buttonhole length is 3 cm ($1\frac{3}{16}$ "). (Total of diameter + thickness of button.)

- > Fit the buttonhole foot with slide.
- > Pull out the button holder plate and insert the button.

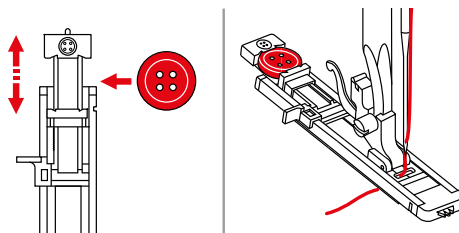

- The buttonhole is sewn to suit the button.

6.4 Reinforce buttonhole

When sewing buttonholes on stretch fabric or coat fabric, hook a filler cord under the buttonhole foot. The filler cord is guided along with the buttonhole foot. Mercerized yarn or fine crochet thread is suitable as a filler cord.

- > Fit the buttonhole foot with slide.
- > Pull out the button holder plate and insert the button.

- > Hang the thread over the hook behind the presser foot and then lay it over the presser foot.

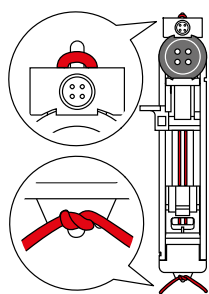

- > Hook both ends of the thread on the front of the presser foot, guide them into the groove and tie them together temporarily.
- > Adjust the stitch length and stitch width.
- > Lower the presser foot.
- > Press the buttonhole lever all the way down and press it backwards slightly until it clicks in position.
- > Use the foot control to start sewing.

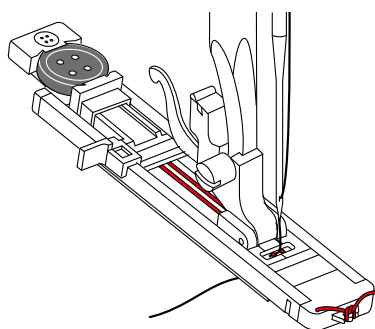

- The buttonhole will sew over the cord, covering it.
- > Re-tighten the filler cord loop until the loop disappears into the bar.
- > Pull the ends of the filler cord to the wrong side using the hand sewing needle and either knot or sew it there.

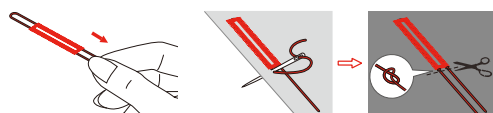

6.5 Sewing a test sample

Always sew a test sample of the buttonhole on the same fabric: It is recommended to use the same stabilizer and to select the same buttonhole. The test sample should also be sewn in the respective direction. Preparing a sewing sample allows you to adjust the settings until the sewing result is as required.

- > Sew a sample buttonhole.
- > Check whether the settings are correct. If required, adjust the buttonhole length, stitch length and stitch width.

6.6 Sewing a buttonhole automatically

- > Fit the buttonhole foot with slide.
- > Pull out the button holder plate and insert the button.
- > Push the button holder plate backwards until it meets the button.
 - The length of the buttonhole is determined.
- > Guide the thread through the hole in the presser foot and then position it under the presser foot.
- > Turn the stitch pattern selector knob to the single-step buttonhole setting.

- > Set the stitch width to 4–6.
- > Set the required stitch length in the buttonhole symbol range on the dial.
- > Position the fabric under the presser foot so that the marking for the center line is aligned with the starting point (1).

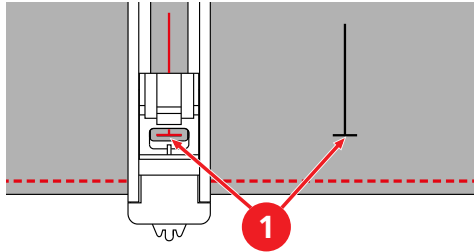

- > Press the buttonhole lever all the way down and press it backwards slightly until it clicks in position.

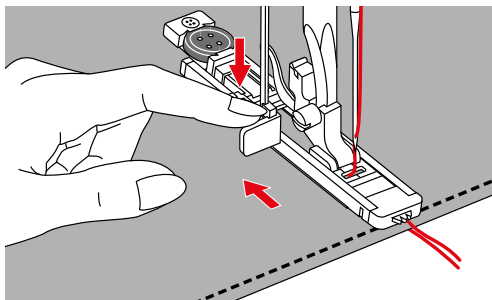

- > Hold the upper thread perpendicular to the buttonhole foot with slide.

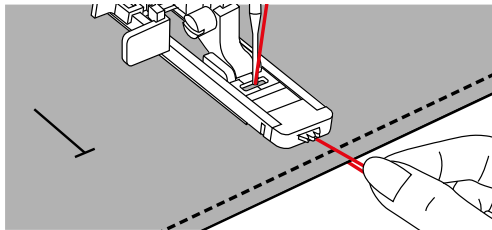

- > Use the foot control to start sewing.
 - The buttonhole is sewn from the front of the presser foot to the back.

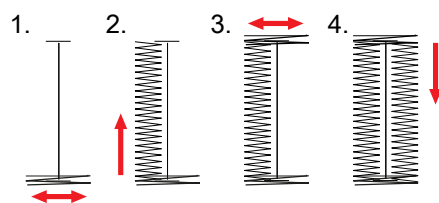

- > At the end of the buttonhole, where the bead meets the bar, stop the machine.
- > Raise the presser foot, remove the fabric and cut the thread.
- > Pull the upper thread downwards and tie it in a knot.
- > If you must interrupt sewing a buttonhole, pull the buttonhole lever forwards and sew 2–3 stitches until the mechanism has switched over.
- > To sew another buttonhole, push the buttonhole lever backwards.

- > After sewing the last buttonhole, lift the buttonhole lever as far as it will go.

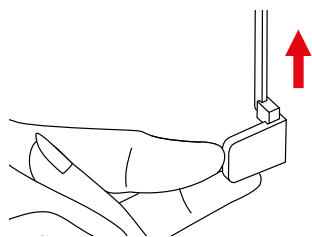

6.7 Cut the buttonhole open

- > Place a pin at each end directly underneath the locking stitch to prevent the stitches being cut open.
- > Cut the opening with the seam ripper.

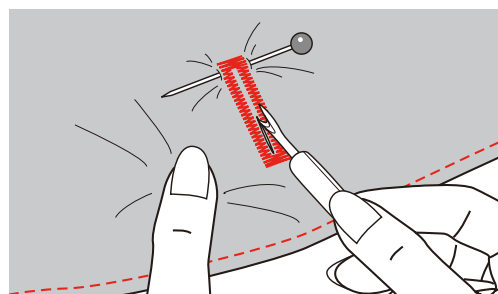

6.8 Sewing on buttons

The button sew-on program can be used to sew on buttons with two or four holes, press studs or snap fasteners.



- > Fit the zigzag foot or button-sew-on foot.
- > Set the stitch pattern selector knob to «B».
- > Lower the feed dog.
- > Adjust the button for the sewing project.
- > For a button with four holes, sew the front holes first.
- > Check distances between holes with the handwheel. If necessary, adjust the stitch width.

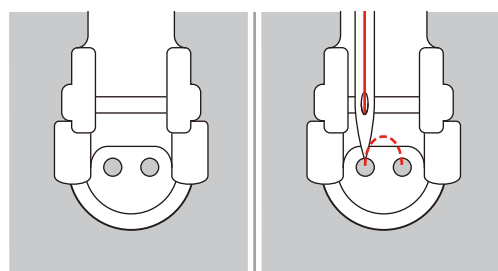

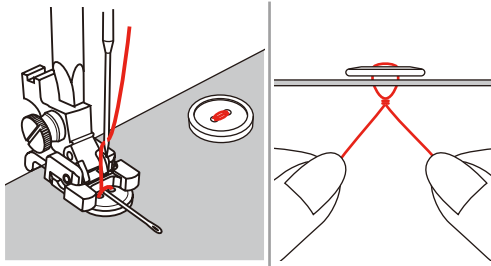

- > Hold the threads when starting to sew.
- > Sew a few stitches using the machine. To ensure stability, sew around 10 stitches.
- > To strengthen the shank, cut the threads, leaving about 10 cm.
- > Bring the upper thread through one of the holes in the button and wind it around the shank.

- > Bring the upper thread to the wrong side of the fabric and tie it in a knot.



7 Quilting

7.1 Overview Quilt Stitches

Stitch pattern	Stitch category	Name	Description	Recommended presser foot	Stitch length	Stitch width
	G	Faggot stitch	For stitching two fabrics together to create a breakthrough look. For quilting, crazy patchwork, decorating and embellishing.	Zigzag foot	S1	6,0
	I	Feather stitch	For crazy patchwork and embellishing.	Zigzag foot	S1	6,0
	D	Blanket stitch	For appliqué, embellishing, finishing and sewing on ribbons	Zigzag foot	S2	6,0

7.2 Appliqués

Appliqués attached using the blanket stitch look as if they have been sewn by hand.

- > Place an appliqué on the fabric and baste or pin it in place, or iron it on using double-sided adhesive non-woven material.
- > Fit the zigzag foot or open embroidery foot.
- > Set the stitch pattern selector knob to position «D».
- > Set the stitch length knob to «S2».
- > Set the required stitch width.
- > Sew while guiding the fabric so the needle falls along the outer edge of the appliqué.
- > When sewing around a corner, stop the machine with the needle in the lower position at the outer edge of the appliqué. Raise the presser foot and pivot the fabric around the needle to change the sewing direction.

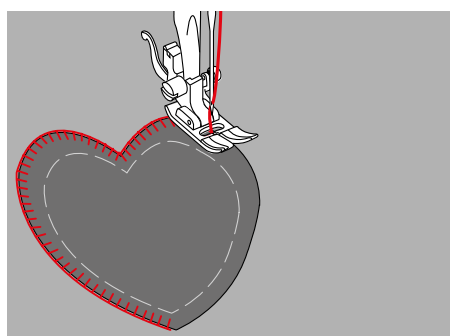

7.3 Guiding the quilt work freely



Quilting gloves with rubber nubs make it easier to guide the fabric.

We recommend using the extension table. When freehand quilting, it is advantageous to start from the center and work outwards. Guide the fabric with gentle, round movements in all directions until the required pattern has been created. Freehand quilting and darning use the same principle of free movement.

With stipple quilting, entire surfaces of the fabric are filled with quilt stitches. The single lines of stitching are rounded and never cross one another.

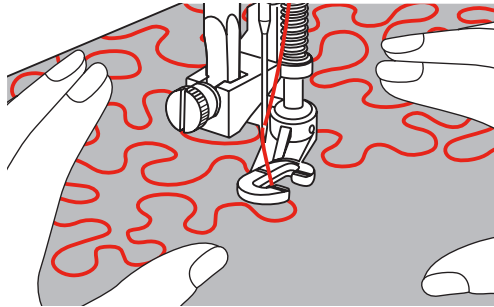

Prerequisite:

- The top layer, the batting and the backing are pinned together or basted.
- > Lower the feed dog.
- > Remove the presser foot holder and fit the freehand embroidery foot or darning/embroidery foot on the presser foot bar.
 - The lever (1) must rest on the top of the needle clamping screw (2).
- > Press the freehand embroidery foot or darning/embroidery foot from underneath with your finger and tighten the screw (3).

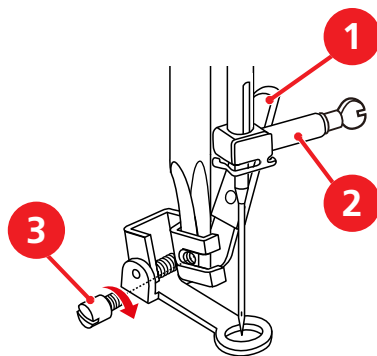

- > Set the stitch length to «0».
- > Set the stitch pattern selector knob to «A».
- > If required, adjust the upper thread tension for the sewing project.
- > Press the foot control to start the machine.
- > Hold both hands close to the presser foot like an embroidery hoop to guide the fabric.
- > If the thread is lying on the top, continue sewing at a slower pace.
- > If knots form on the wrong side of the fabric, guide the fabric more quickly.

7.4 Sewing patchwork

Sewing patchwork parts together

- > Fit the zigzag foot or patchwork foot.
- > Set the stitch pattern selector knob to «A».
- > Set the stitch length knob to the required stitch length of 1–3.
- > Set the needle position to «Center».
- > Place the two parts with the right sides together.

- > Sew the parts together with a seam allowance of 5 mm or guide the parts along the patchwork foot guide.

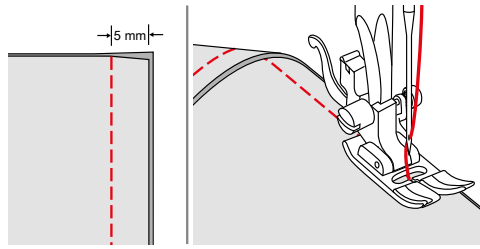

- > Iron the seam allowance apart.

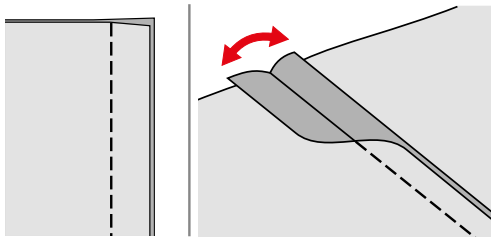

Embellishing seams

- > Fit the zigzag foot.
- > Set the decorative stitch you have chosen.
- > Set the required stitch width.
- > Set the needle position to «Center».
- > Continue to work on the right side of the fabric.
- > Place the joining seam under the center of the presser foot.
- > Sew over the seam using a decorative stitch.

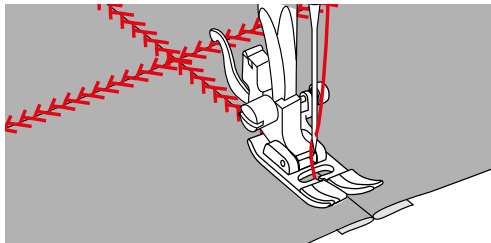

8 Maintenance and cleaning

8.1 Cleaning the feed dog

Remaining threads under the stitch plate must occasionally be removed.



Electronically driven components

Risk of injury near the needle and the hook.

- > Raise the presser foot.
- > Switch off the machine and disconnect it from the power supply.

- > Switch off the machine and disconnect it from the power supply.
- > Remove the presser foot and the needle.
- > Lower the feed dog.

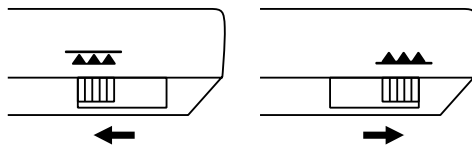

- > Push the unlocking lever (1) to the right and remove the bobbin cover (2).

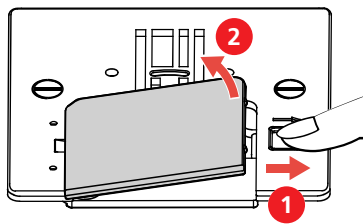

- > Loosen both screws and remove the stitch plate.

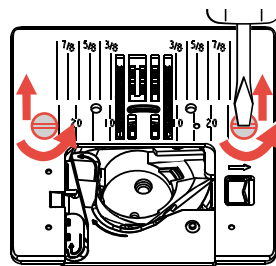

- > Clean the feed dog with the brush.

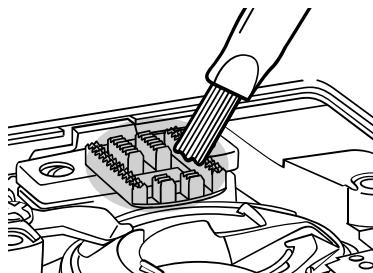

- > Insert the stitch plate. Insert and tighten the two screws.
- > Insert the bobbin cover.
- > Lift the feed dog.
- > Insert a needle.

- > Attach the presser foot.
- > Connect the machine to the mains power and switch it on.

8.2 Cleaning the hook



Electronically driven components

Risk of injury near the needle and the hook.

- > Raise the presser foot.
- > Switch off the machine and disconnect it from the power supply.

- > Remove the presser foot and the needle.
- > Remove the stitch plate.
- > Clean the bobbin case with the brush.

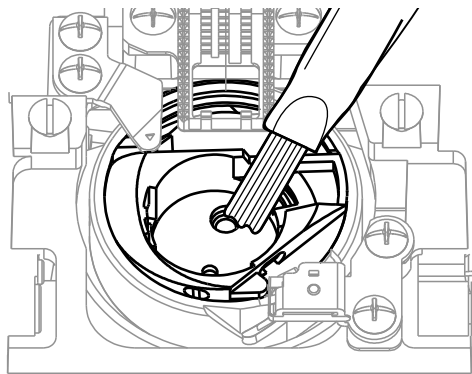

- > Set needle to topmost position.
- > Remove the bobbin case.

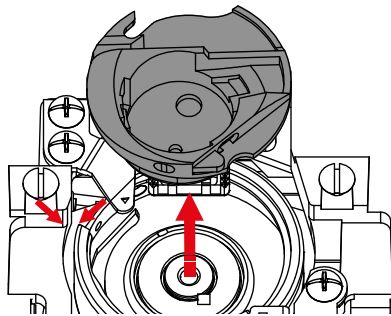

- > Clean the shuttle race with the brush.

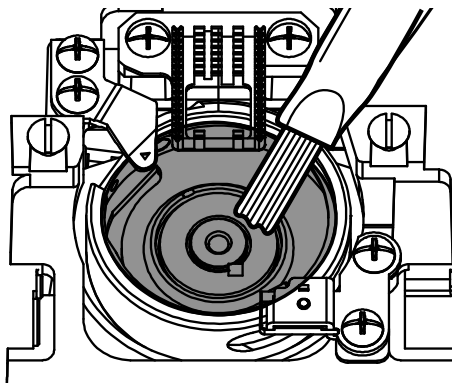

- > Insert the bobbin case.

Note: The markings of the bobbin case and the stitch plate must be aligned identically.

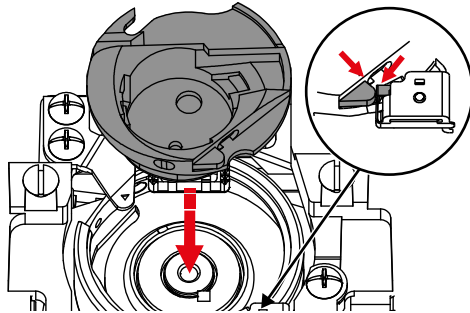

- > Fit the stitch plate.
- > Fit the bobbin cover.
- > Fit the needle and presser foot.

8.3 Oiling the needle bar

Without lubrication, the needle bar may not move smoothly. If the machine is used frequently, the needle bar must be oiled every six months in order to prevent a blockage.



Electronically driven components

Risk of injury near the needle bar.

- > Switch off the machine and disconnect it from the power supply.

- > Remove the protective cap (1) and screw (2).

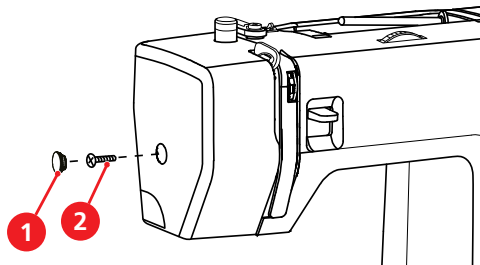

- > Remove the stand head cover (3).
 - Watch out for moving parts after the stand head cover has been removed.

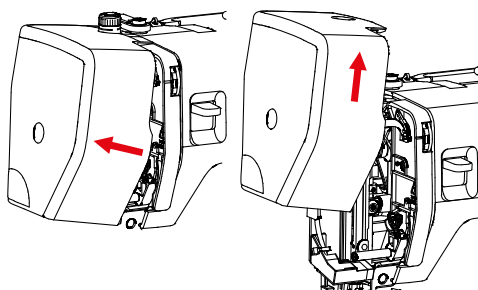

- > Apply a drop of oil to the movement mechanism of the needle bar, including the connecting rod/needle bar, needle bar holder and needle bar holder (apply oil to the points marked with an arrow).

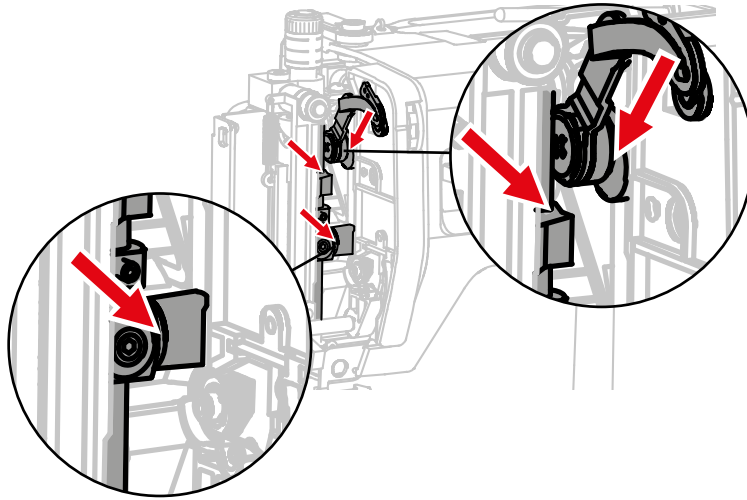

- > Turn the handwheel a few times and remove any excess oil with a cloth.
- > Attach the headframe cover again.

9 Troubleshooting

Fault	Cause	Solution
Uneven stitch formation	Upper thread too tight or too loose.	> Adjust the upper thread tension.
	Needle blunt or bent.	> Replace the needle, make sure that a new BERNINA quality needle is used.
	Poor quality needle.	> Use a new BERNINA quality needle.
	Poor quality thread.	> Use quality thread.
	Incorrect needle/thread combination.	> Match the needle with the thread size.
	Incorrectly threaded.	> Rethread the thread.
	The fabric has been pulled.	> Feed the fabric evenly.
	Dust or thread remnants under the tension spring of the bobbin case.	> Clean the bobbin case (see page 71).
Skipped stitches	Incorrect needle.	> Use the needle system 130/705H.
	Needle blunt or bent.	> Replace the needle.
	Poor quality needle.	> Use a new BERNINA quality needle.
	The needle is incorrectly inserted.	> Insert the needle with the flat side to the back as far up as it will go into the needle holder and tighten the screw.
	Incorrect needle point.	> Match the needle point to the texture of the material.
Faulty stitching	Thread remnants between the thread tension discs.	> Fold a piece of thin material and slide the folded edge (not the raw edges) between the thread tension discs.
	Incorrectly threaded.	> Rethread.
	Thread is caught in the hook.	> Remove the upper thread and the bobbin case, turn the handwheel backwards and forwards by hand and remove the thread remnants.
	Incorrect needle/thread combination.	> Check the needle/thread combination.

Fault	Cause	Solution
Upper thread breaks	Incorrect needle/thread combination.	> Match the needle with the thread size.
	Upper thread is too tight.	> Reduce the upper thread tension.
	Incorrectly threaded.	> Rethread.
	Poor quality thread.	> Use quality thread.
	The stitch plate or the hook tip is damaged.	> Contact a specialized bernette dealer to have the damages repaired. > Replace the stitch plate.
Lower thread breaks	The bobbin is not inserted correctly.	> Remove and reinsert the bobbin and pull on the thread. – The thread should run easily.
	The bobbin is wound incorrectly.	> Check bobbin and thread correctly.
	The stitch hole in the stitch plate is damaged.	> Contact a specialized bernette dealer to have the damages repaired. > Replace the stitch plate.
	Needle blunt or bent.	> Replace the needle.
Needle breaks	The needle is incorrectly inserted.	> Insert the needle with the flat side to the back as far up as it will go into the needle holder and tighten the screw.
	The fabric has been pulled.	> Feed the fabric evenly.
	Thick fabric has been pushed.	> Use a presser foot that is suitable for thick fabric. > Use the height compensating tool when sewing over a thick seam.
	The thread is knotted.	> Use quality thread.
The machine doesn't start	The machine is switched off.	> Switch the machine on.
	The machine is not plugged in.	> Plug in the power plug.
	The machine is defective.	> Contact a specialist bernette dealer.
	Unfavorable room temperature.	> Place the machine in a warm room one hour before use. > Connect the machine and switch it on.
	The presser foot is raised.	> Lower the presser foot.
Neither the sewing light nor the light on the free arm lights up	The sewing light is defective.	> Contact a specialist bernette dealer.

10 Technical data

Designation	Value	Unit
Sewing light (LED)	200	mW
Maximum speed	1100	Stitches per minute
Measurements (W × D × H)	416 × 174 × 299	mm
Weight	7.07	kg
Input voltage (energy consumption)	120 (0.7)	V (A)
	230/240 (90)	V (W)
Sound pressure level	80	dB (A)
Protection class (electrical engineering)	Protection class II	

11 Appendix

11.1 Overview stitch patterns

Overview of the stitch patterns

Stitch length knob	Stitch selector wheel												
		A	B	C	D	E	F	G	H	I	J	K	L
0 – 4													
S1													
S2													

Index

A

Accessories overview.....	11
Accessory box.....	20
Adjusting the presser foot pressure.....	24
Attaching the seam guide.....	24

B

Balance dial.....	38
Buttonholes.....	62

C

Changing the needle.....	21
Changing the presser foot.....	23
Changing the presser foot holder.....	24
Cleaning the feed dog.....	70
Cleaning the hook.....	71
Connecting the foot control.....	17
Connecting the machine.....	17

D

Decorative stitches.....	57
--------------------------	----

E

Environmental Protection.....	7
Explanation of symbols.....	8

F

Feed dog up/down.....	20
Fitting finger guard.....	25
Fitting the presser foot sole.....	23

H

Height compensating tool.....	40
-------------------------------	----

I

Inserting the spool.....	19
Inserting the spool disc.....	18

M

Machine overview	
Front.....	9
Rear.....	11
Top.....	10

Maximum sewing speed.....	17
---------------------------	----

N

Needle position right/left.....	22
Needle position up/down.....	21
Needle, Thread and Fabric.....	13
Needles and threads.....	15
Needles overview.....	14
Needles, Threads.....	16

P

Power switch.....	17
Preparing the threading.....	26
Presser feet overview.....	12
Presser foot up/down.....	23
Removing the presser foot sole.....	23

R

Regulating the speed.....	17
Reverse sewing.....	39
Reverse sewing lever.....	39

S

Safety Instructions.....	5
Second spool pin.....	19
Securing.....	40
Sewing corners.....	41
Sewing difficult fabrics.....	41
Sewing table.....	20
Slide-on table.....	20
Stitch length.....	37
Stitch pattern selector knob.....	36
Stitch selection.....	36
Stitch width.....	37
Switching the machine on.....	17

T

Technical specifications.....	76
Threading the bobbin thread.....	33
Threading the triple needle.....	30
Threading the twin needle.....	30
Threading the upper thread.....	26
Troubleshooting.....	74

U

Upper thread tension.....	37
Using a spool net.....	18
Utility stitches	42

W

Winding the bobbin thread.....	31
--------------------------------	----



2020-09 EN
5220205.00A.04

© BERNINA International AG
Steckborn CH, www.bernina.com

www.bernette.com/b05ACADEMY