

BEVERLY FIRE PIT

Hammered, Corten Steel, Stainless Steel, Powder Coat

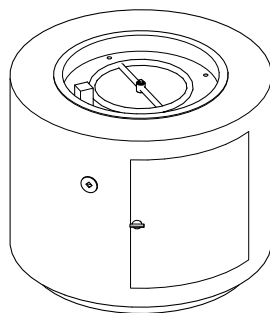

ISOMETRIC VIEW

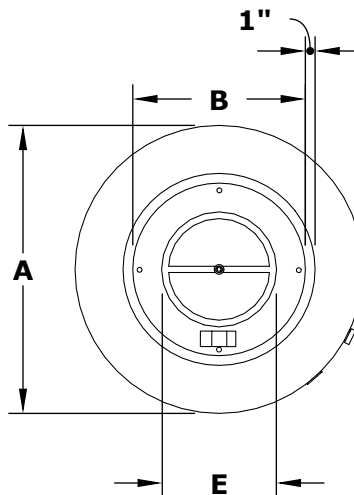

TOP VIEW

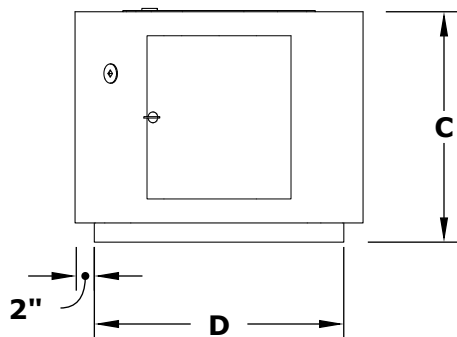

RIGHT SIDE VIEW

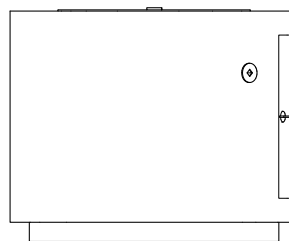

FRONT SIDE VIEW

Hammered Copper	Corten Steel	Stainless Steel	Powder Coat	A	B	C	D	E	BTU
OPT-30RRCP	OPT-30RRCS	OPT-30RRSS	OPT-30PCB	30"	19"	24"	26"	12"	50,000
OPT-36RRCP	OPT-36RRCS	OPT-36RRSS	OPT-36PCB	36"	25"	24"	30"	18"	75,000
OPT-42RRCP	OPT-42RRCS	OPT-42RRSS	OPT-42PCB	42"	31"	24"	36"	25"	90,000

Fire Pit Material: GFRC Concrete
 Pan Material: 304 Stainless Steel
 Burner Material: 304 Stainless Steel

Standard 1" Flange on all pans
 Standard 2" Depth on all pans
110V ELECTRONIC IGNITION
 ANSI Z21.97-(2017) / CSA 2.41-(2017)



Match Lit Unit Includes: Pan, Burner, Gas Orifice, Gas Hoses, Key Valve, Key,
 110v Ignition Unit Includes: Pan, Burner, Gas Orifice, Gas Hoses, Key Valve, Key, Plug & Play Electronic Valve, Pilot Igniter.

Proprietary & Confidential: The information contained in this drawing is the sole property of **The Outdoor Plus**. Any reproduction or as a whole without written permission of **The Outdoor Plus** is prohibited.