

baridi

45cm Slimline Freestanding Dishwasher, 10 Place Settings, 8 Programs, LED Display - Silver

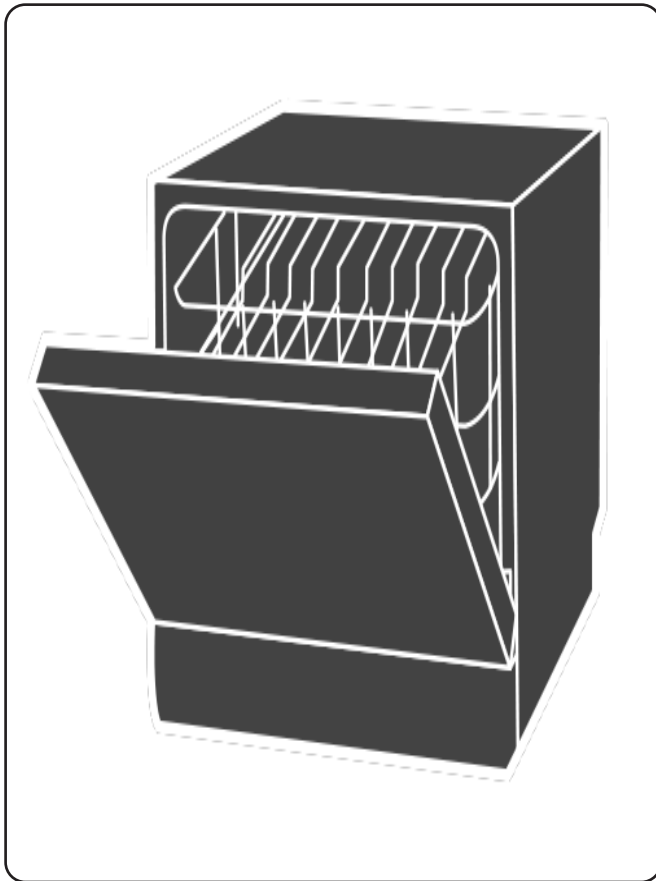

Model No: DH166

Thank you for purchasing a Baridi product from the Dellonda range. Manufactured to a high standard, this product will, if used according to these instructions, and properly maintained, give you years of trouble free performance.

CONTENTS

•	General safety	3
•	Electrical safety	4
•	Product overview	5
•	Using	
•	Loading salt	6
•	Basket loading tips	8
•	Maintenance and cleaning	
•	External care	9
•	Internal care	9
•	General care	12
•	Installation	
•	Power connection	13
•	Water supply and drain	14
•	Connection of drain hoses	15
•	Positioning	16
•	Quick user guide	18
•	Loading the baskets	19
•	Saving energy	21
•	Starting a program	21
•	Changing a programme mid cycle	21
•	Forget to a dish?	22
•	Control panel	23
•	Water softener	26
•	Preparing and loading dishes	27
•	Function of rinse aid & detergent	30
•	Filling the rinse aid reservoir	31
•	Filling the detergent dispenser	32
•	Wash cycle table	33
•	Starting a cycle wash	35
•	Changing the programme mid cycle	35
•	Forget to add a dish	36
•	Error codes	37
•	Trouble shooting tips	38
•	Technical information	42
•	Product information sheet	43

Important Information

Please read these instructions carefully and note any safe operational requirements, warnings & cautions. Use the product correctly and with care for the purpose for which it is intended. Failure to do so may cause damage and/or personal injury and will invalidate the warranty. Keep these instructions safe for future use.



Refer to
instructions



Indoor use
only

• GENERAL SAFETY

- **WARNING!** When using this dishwasher, follow the precautions listed below.
- **WARNING:** Ensure the supply cord is not trapped or damaged.
- **WARNING: DO NOT** locate multiple portable socket-outlets or portable power supplies at the rear of the appliance.
- This appliance is intended to be used in household and similar applications such as staff kitchen areas in shops, offices and other working environments; holiday homes, hotels and other residential settings; and catering and similar non-retail applications.
- This appliance can be used by children aged from 8 years and above and persons with reduced physical, sensory or mental capabilities or lack of knowledge and experience if they have been given supervision or instruction concerning the use of the appliance in a safe way and understand the hazards involved. Children shall not play with the appliance. Cleaning and user maintenance shall not be made by children without supervision (EN60335-1).
- Packaging materials could be dangerous for children.
- **DO NOT** abuse, sit on or stand on the door or dish rack of the dishwasher
- **DO NOT** operate this dishwasher unless the unit is fully assembled and all enclosures panels are fully in place.
- **DO NOT** open the door whilst the dishwasher is switched on and operating, you are at risk of scalding from hot water and steam.
- When loading the dishwasher locate sharp items so that are unlikely to damage the door seals. Knives and other utensils with sharp points must be loaded in the cutlery basket with their points facing down or placed horizontally on a shelf.
- Some dishwasher detergents have strong alkalinity, they are extremely dangerous if ingested, avoid contact with skin and eyes and keep children away from the dishwasher when the door is open.
- Always check there is no detergent residue left after the completion of a wash cycle.
- **DO NOT** wash plastic items unless they are marked dishwasher safe.
- Use only detergents and rinse agents that are recommended for use with automatic dishwashers .
- Never use soap, laundry detergent, or hand washing detergents in this dishwasher.
- **DO NOT** leave the door of this dishwasher open when the appliance is not in use.
- **DO NOT** tamper with the appliance or controls.
- If the appliance is moved it is recommended it is installed with new hose sets and **NOT** reused ones
- In Stand by mode the appliance will switch off automatically after 15 minutes without any user interaction
- The maximum number of place settings to be washed is 10.

• ELECTRICAL SAFETY

- **WARNING!** It is the user's responsibility to check the following:
 - Check all electrical equipment and appliances to ensure that they are safe before using. Inspect power supply leads, plugs and all electrical connections for wear and damage. Dellonda recommend that an (Residual Current Device) is used with all electrical products. You may obtain an RCD by contacting your local domestic stockist. If the product is used in the course of business duties, it must be maintained in a safe condition and routinely PAT (Portable Appliance Test) tested.
- **Electrical safety information:** It is important that the following information is read and understood.
- Ensure that the insulation on all cables and on the appliance is safe before connecting it to the power supply
- Regularly inspect power supply cables and plugs for wear or damage and check all connections to ensure that they are secure.
- **Important:** Ensure that the voltage rating on the appliance suits the power supply to be used and that the plug is fitted with the correct fuse - see fuse rating in these instructions.
- **DO NOT** pull or carry the appliance by the power cable.
- **DO NOT** pull the plug from the socket by the cable.
- **DO NOT** use worn or damaged cables, plugs or connectors.
- Ensure that any faulty item is repaired or replaced immediately by a qualified electrician.
- This product is fitted with a BS1363/A 13 Amp
- 3 pin plug. If the cable or plug is damaged during use, switch off the electricity supply and remove from use.
- Ensure that repairs are carried out by a qualified electrician.
- Replace a damaged plug with a BS1363/A 13 amp 3 pin plug.
- If in doubt contact a qualified electrician.
- Ensure that the cable outer sheath extends inside the cable restraint and that the restraint is tight.
- Dellonda recommend that repairs are carried out by a qualified electrician.

A) Connect the GREEN/YELLOW earth wire to the earth terminal 'E'.

B) Connect the BROWN live wire to the live terminal 'L'.

C) Connect the BLUE neutral wire to the neutral terminal 'N'

• SPECIFICATION

- **Model no:** DH166
- Dimensions (W x D x H): 445 x 600 x 845mm
- Place settings: 10
- Supply: 220-240V
- Type: Freestanding

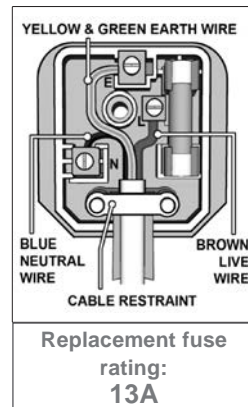

PRODUCT OVERVIEW

❗ IMPORTANT:

To get the best performance from your dishwasher, read all operating instructions before using it for the first time.

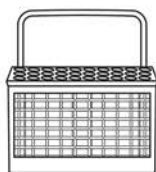
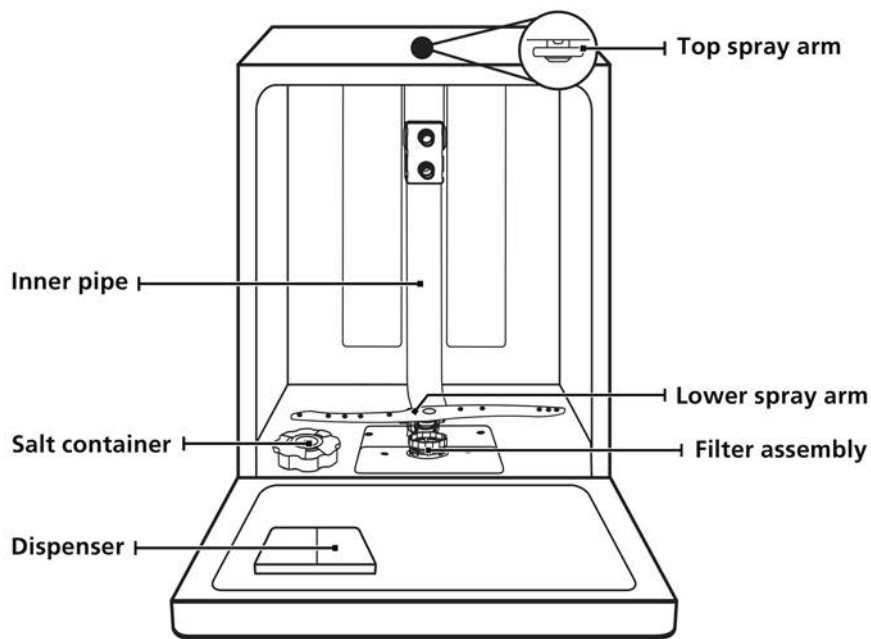

Cutlery basket

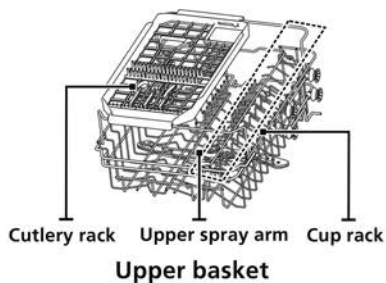

Upper basket



Lower basket

💡 NOTE:

Pictures are only for reference, different models may be different.

USING YOUR DISHWASHER

Before using your dishwasher :

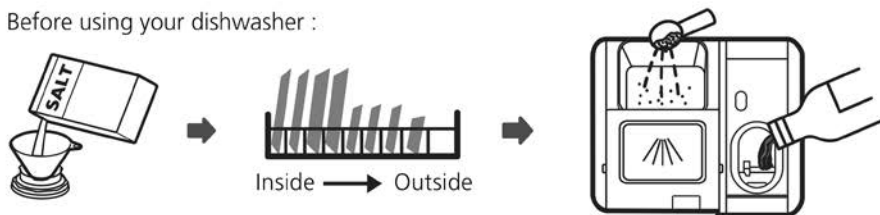

1. Set the water softener
2. Loading the salt into the softener
3. Loading the basket
4. Fill the detergent dispenser

Loading The Salt Into The Softener

NOTE:

Always use salt intended for dishwasher use.

The salt container is located beneath the lower basket and should be filled as explained in the following:

WARNING

- **Only use salt specifically designed for dishwashers use!**
Every other type of salt not specifically designed for dishwasher use, especially table salt, will damage the water softener. In case of damages caused by the use of unsuitable salt the manufacturer does not give any warranty nor is liable for any damages caused.
- **Only fill with salt before running a cycle.**
This will prevent any grains of salt or salty water, which may have been spilled, remaining on the bottom of the machine for any period of time, which may cause corrosion.

Please follow the steps below for adding dishwasher salt:

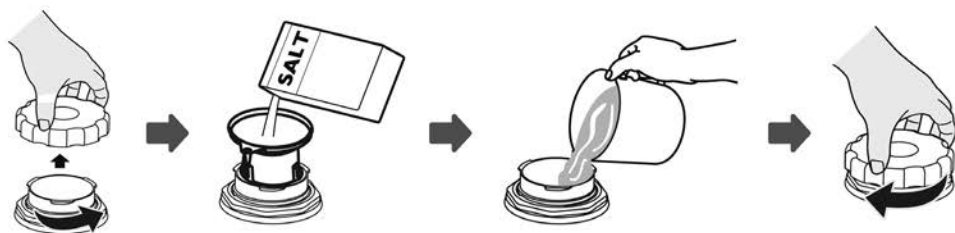

1. Remove the lower basket and unscrew the reservoir cap.
2. Place the end of the funnel (if supplied) into the hole and pour in about 1.5 kg of dishwasher salt.
3. Fill the salt container to its maximum limit with water, It is normal for a small amount of water to come out of the salt container.
4. After filling the container, screw back the cap tightly.
5. The salt warning light will turn off after the salt container has been filled with salt.
6. Immediately after filling the salt into the salt container, a washing program should be started (We suggest to use a short program). Otherwise the filter system, pump or other important parts of the machine may be damaged by salty water. This is out of warranty.

NOTE:

- The salt container must only be refilled when the salt warning light () in the control panel comes on. Depending on how well the salt dissolves, the salt warning light may still be on even though the salt container is filled.
If there is no salt warning light in the control panel (for some models), you can estimate when to fill the salt into the softener by the cycles that the dishwasher has run.
- If salt has spilled, run a soak or quick program to remove it.

Basket Loading Tips

Sliding cutlery rack

The cutlery rack can slide to the right or left at will.

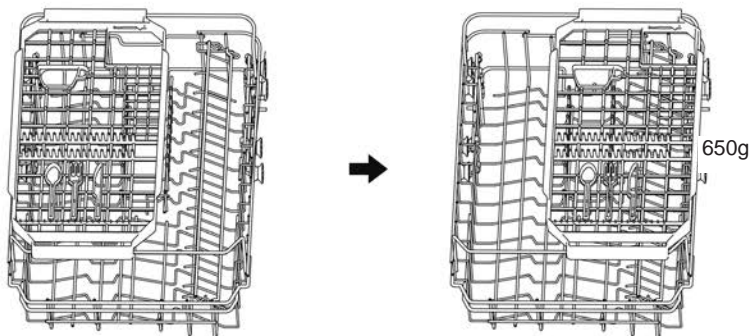

Folding back the cup shelves

To make room for taller items in the upper basket, raise the cup rack upwards. You can then lean the tall glasses against it. You can also remove it when it is not required for use.



Folding back the rack shelves

The spikes of the lower basket are used for holding plates and a platter. They can be lowered to make more room for large items.

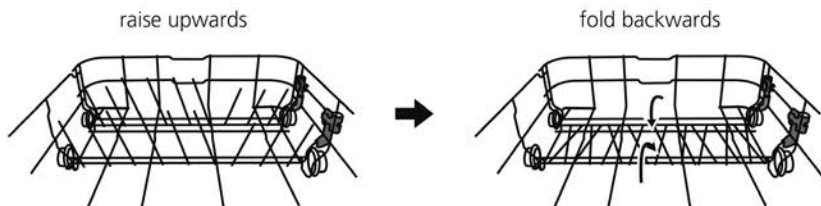

MAINTENANCE AND CLEANING

External Care

The door and the door seal

Clean the door seals regularly with a soft damp cloth to remove food deposits. When the dishwasher is being loaded, food and drink residues may drip onto the sides of the dishwasher door. These surfaces are outside the wash cabinet and are not accessed by water from the spray arms. Any deposits should be wiped off before the door is closed.

The control panel

If cleaning is required, the control panel should be wiped with a soft damp cloth only.

⚠ WARNING

- To avoid penetration of water into the door lock and electrical components, do not use a spray cleaner of any kind.
- Never use abrasive cleaners or scouring pads on the outer surfaces because they may scratch the finish. Some paper towels may also scratch or leave marks on the surface.

Internal Care

Filtering system

The filtering system in the base of the wash cabinet retains coarse debris from the washing cycle, including foreign objects such as tooth picks or shards. The collected coarse debris may cause the filters to clog. Check the condition of the filters regularly, carefully remove foreign objects and clean the parts of the filtering system if necessary with water. Follow the steps below to clean the filter.

☀ NOTE:

Pictures are only for reference, different models of the filtering system and spray arms may vary.

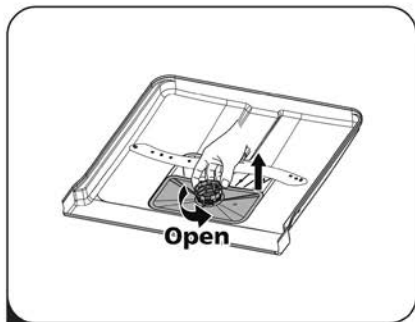

- 1** Hold the coarse filter and rotate it anticlockwise to unlock the filter. Lift the filter upwards and out of the dishwasher.

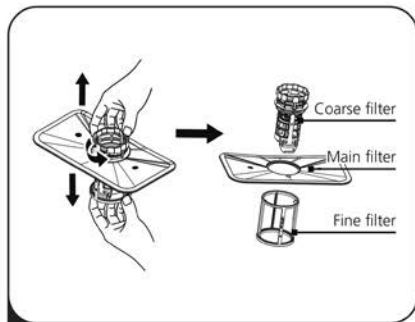

- 2** The fine filter can be pulled off the bottom of the filter assembly. The coarse filter can be detached from the main filter by gently squeezing the tabs at the top and pulling it away.

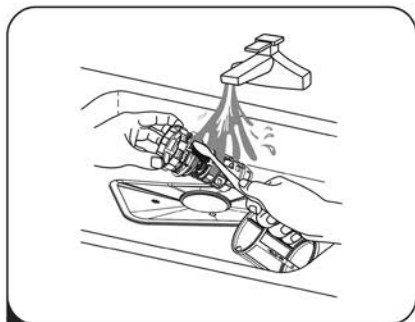

- 3** Larger food remnants can be cleaned by rinsing the filter under running water. For a more thorough clean, use a soft cleaning brush.

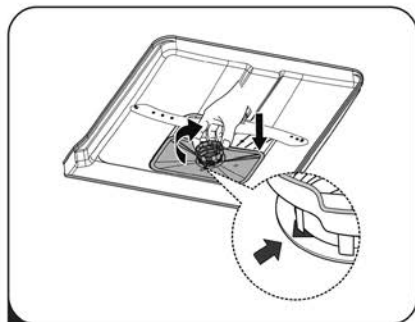

- 4** Reassemble the filters in the reverse order of the disassembly, replace the filter insert, and rotate clockwise to the close arrow.

⚠ WARNING

- Do not over tighten the filters. Put the filters back in sequence securely, otherwise coarse debris could get into the system and cause a blockage.
- Never use the dishwasher without filters in place. Improper replacement of the filter may reduce the performance level of the appliance and damage dishes and utensils.

Spray arms

It is necessary to clean the spray arms regularly for hard water chemicals will clog the spray arm jets and bearings.

To clean the spray arms, follow the instructions below:

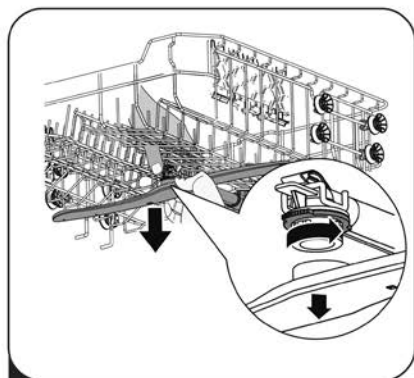

- 1** To remove the upper spray arm, hold the nut in the center still and rotate the spray arm counterclockwise to remove it.

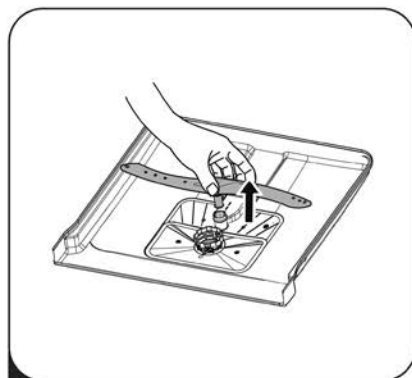

- 2** To remove the lower spray arm, pull out the spray arm upward.

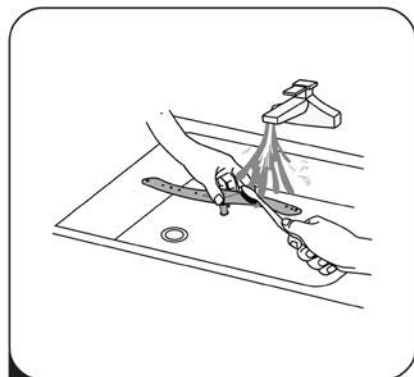

- 3** Wash the arms in soapy and warm water and use a soft brush to clean the jets. Replace them after rinsing them thoroughly.

Caring For The Dishwasher

Frost precaution

Please take frost protection measures on the dishwasher in winter. Every time after washing cycles, please operate as follows:

1. Cut off the electrical power to the dishwasher at the supply source.
2. Turn off the water supply and disconnect the water inlet pipe from the water valve.
3. Drain the water from the inlet pipe and water valve. (Use a pan to gather the water)
4. Reconnect the water inlet pipe to the water valve.
5. Remove the filter at the bottom of the tub and use a sponge to soak up water in the sump.

After every wash

After every wash, turn off the water supply to the appliance and leave the door slightly open for a while so that moisture and odors are not trapped inside.

Remove the plug

Before cleaning or performing maintenance, always remove the plug from the socket.

No solvents or abrasive cleaning

To clean the exterior and rubber parts of the dishwasher, do not use solvents or abrasive cleaning products. Only use a cloth with warm soapy water.

To remove spots or stains from the surface of the interior, use a cloth dampened with water and a little vinegar, or a cleaning product made specifically for dishwashers.

When not in use for a long time

It is recommended that you run a wash cycle with the dishwasher empty and then remove the plug from the socket, turn off the water supply and leave the door of the appliance slightly open. This will help the door seals to last longer and prevent odors from forming within the appliance.

Moving the appliance

If the appliance must be moved, try to keep it in the vertical position. If absolutely necessary, it can be positioned on its back.

Seals

One of the factors that cause odours to form in the dishwasher is food that remains trapped in the seals. Periodic cleaning with a damp sponge will prevent this from occurring.

INSTALLATION INSTRUCTION

⚠ WARNING



Electrical Shock Hazard

Disconnect electrical power before installing dishwasher. Failure to do so could result in death or electrical shock.

⚠ Attention

The installation of the pipes and electrical equipments should be done by professionals.

About Power Connection

⚠ WARNING

For personal safety:

- Do not use an extension cord or an adapter plug with this appliance.
- Do not, under any circumstances, cut or remove the earthing connection from the power cord.

Water Supply And Drain

Cold water connection

Connect the cold water supply hose to a threaded 3/4(inch) connector and make sure that it is fastened tightly in place.

If the water pipes are new or have not been used for an extended period of time, let the water run to make sure that the water is clear. This precaution is needed to avoid the risk of the water inlet to be blocked and damage the appliance.



ordinary supply hose



safety supply hose
(not supplied)

About the safety supply hose

The safety supply hose consists of the double walls. The system guarantees its intervention by blocking the flow of water in case of the supply hose breaking and when the air space between the supply hose itself and the outer corrugated hose is full of water.

⚠ WARNING

A hose that attaches to a tap can burst if it is installed on the same water line as the dishwasher. If your sink has one, it is recommended that the hose be disconnected and the hole plugged.

Connection Of Drain Hoses

Insert the drain hose into a drain pipe with a minimum diameter of 4 cm, or let it run into the sink, making sure to avoid bending or crimping it. The height of drain pipe must be less than 1000 mm. The free end of the hose must not be immersed in water to avoid the back flow of it.

⚠ Please securely fix the drain hose in either position A or position B

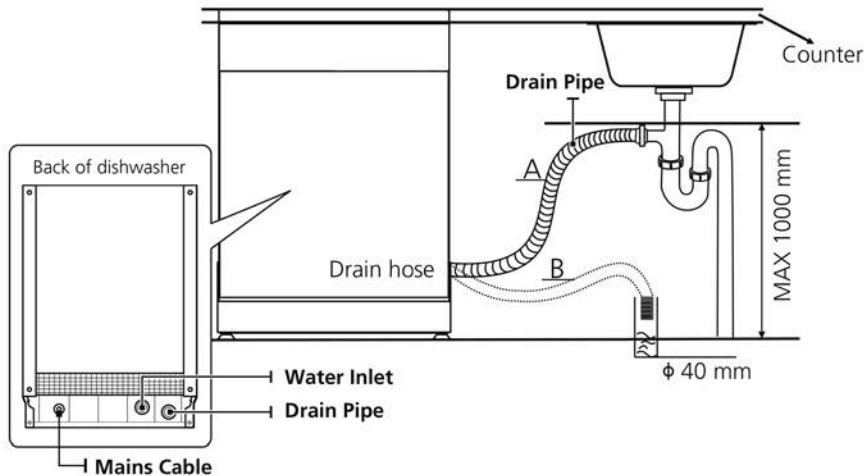

How to drain excess water from hoses

If the connection to the drain pipe is positioned higher than 1000 mm, excess water may remain in the drain hose. It will be necessary to drain excess water from the hose into a bowl or suitable container that is held outside and lower than the sink.

Water outlet

Connect the water drain hose. The drain hose must be correctly fitted to avoid water leaks. Ensure that the water drain hose is not kinked or squashed.

Extension hose

If you need a drain hose extension, make sure to use a similar drain hose. It must not be longer than 4 meters, otherwise the cleaning effect of the dishwasher could be reduced.

Syphon connection

The waste connection must be at a height less than 1000 mm (maximum) from the bottom of the dishwasher.

Positioning The Appliance

Position the appliance in the desired location. The back should rest against the wall behind it, and the sides, along the adjacent cabinets or walls. The dishwasher is equipped with water supply and drain hoses that can be positioned either to the right or the left sides to facilitate proper installation.

Levelling the appliance

Once the appliance is positioned for levelling, the height of the dishwasher may be altered via adjustment of the screwing level of the feet. In any case, the appliance should not be inclined more than 2°.

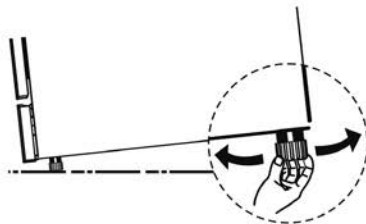

Free Standing Installation

Fitting between existing

The height of the dishwasher, 845 mm, has been designed in order to allow the machine to be fitted between existing cabinets of the same height in modern fitted kitchens. The laminated top of the machine does not require any particular care since it is heatproof, scratchproof and stainproof.

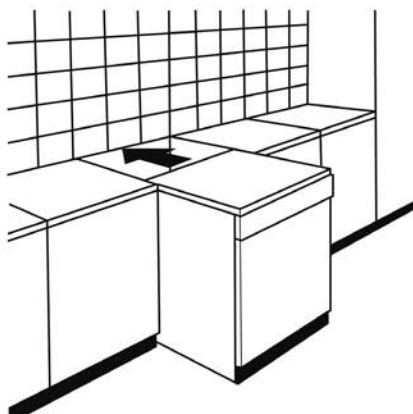

Underneath existing work top

(When fitting beneath a work top)

In most modern fitted kitchens there is only one single work top under which cabinets and electrical appliances are fitted. In this case remove the work top of the dishwasher by unscrewing the screws under the rear edge of the top (**a**).

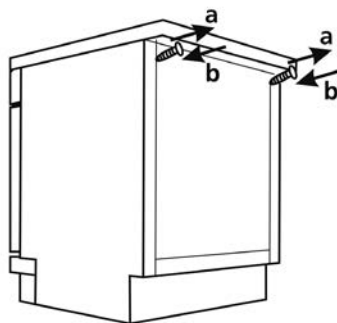

⚠ Attention

After removing the work top, the screws must be screwed again under the rear edge of the top (**b**).

QUICK USER GUIDE

Please read the corresponding content on the instruction manual for detailed operating method.

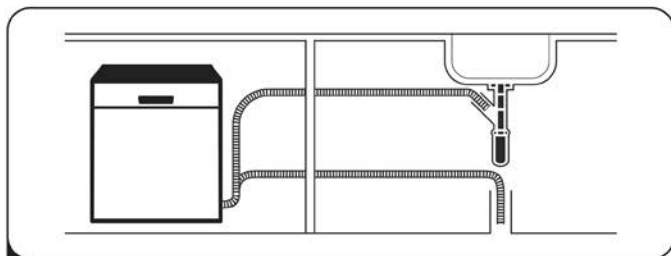

1 Install the dishwasher

Please check the section "INSTALLATION INSTRUCTION"



2 Removing the larger residue on the cutlery

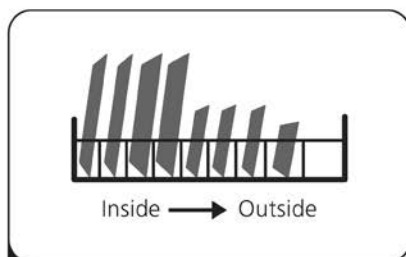

3 Loading the baskets

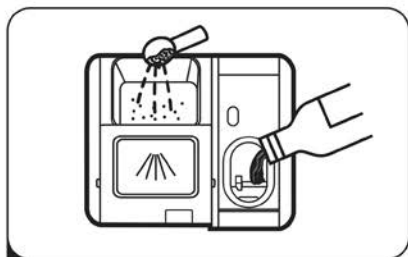

4 Filling the dispenser



5 Selecting a program and running the dishwasher

LOADING THE BASKETS ACCORDING TO EN60436:

Loading the dishwasher to its full capacity will contribute to energy and water savings.

1.Upper basket:

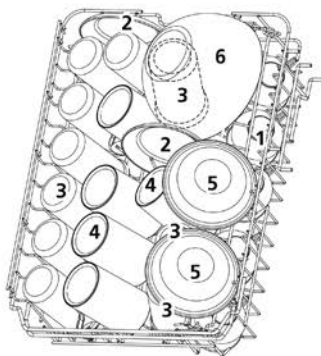

Number	Item
1	Cups
2	Saucers
3	Glasses
4	Mugs
5	Dessert bowls
6	Glass bowl

2.Lower basket:

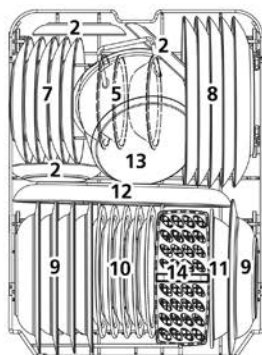

Number	Item
7	Dessert plates
8	Dinner plates
9	Soup plates
10	Melamine dessert plates
11	Melamine bowl
12	Oval platter
13	Small pot
14	Cutlery basket

3. Cutlery rack:

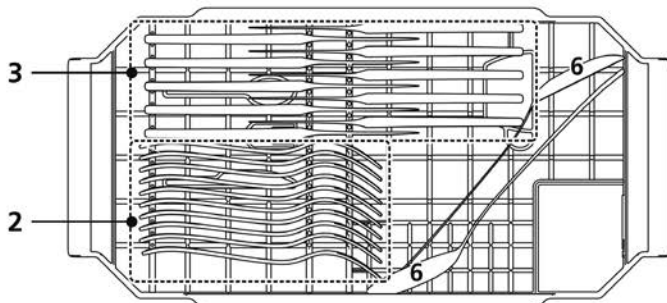

4. Cutlery basket:

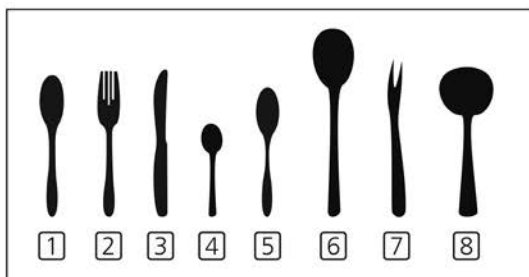
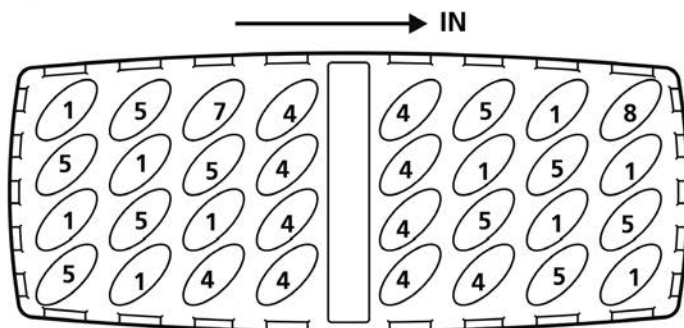

Number	Item
1	Soup spoons
2	Forks
3	Knives
4	Teaspoons
5	Dessert spoons
6	Serving spoons
7	Serving forks
8	Gravy ladles

Information for comparability tests in accordance with EN60436
 Capacity: 10 place settings
 Position of the upper basket: lower position
 Program: ECO
 Rinse aid setting: Max
 Softener setting: H3

Saving Energy

1. Pre-rinsing of tableware items leads to increased water and energy consumption and is not recommended.
2. Washing tableware in a household dishwasher usually consumes less energy and water in the use phase than hand dishwashing when the household dishwasher is used according to the instructions.

Starting A Program

1. Draw out the basket, load the dishes and push them back.
2. Pour in the detergent.
3. Insert the plug into the socket. Make sure that the water supply is turned on to full pressure.
4. Close the door, press the Power button to switch on the machine.
5. Choose a program, the response light will turn on. Then press the Start/Pause button, the dishwasher will start its cycle.

Changing The Program Mid-cycle

A program can only be changed if it has been running only for a short period of time, otherwise the detergent may have already been released or the the wash water with detergent has already been drained. If this is the case, the dishwasher needs to be reset and the detergent dispenser must be refilled. To reset the dishwasher, follow the instructions below:

1. Press the Start/Pause button to pause the washing.
2. Press Program button for more than 3 seconds, the machine will be in program selection mode.
3. Press the Program button to select the desired program.
4. Press the Start/Pause button, after 1 seconds, the dishwasher will start.

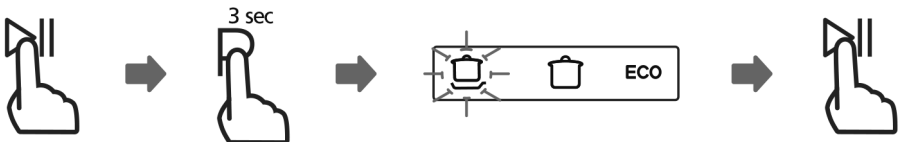

Forget To Add A Dish?

A forgotten dish can be added any time before the detergent dispenser opens. If this is the case, follow the instructions below:

1. Press the Start/Pause button to pause the washing.
2. Wait 5 seconds then open the door.
3. Add the forgotten dishes.
4. Close the door.
5. Press the Start/Pause button after 10 seconds, the dishwasher will start.



⚠ WARNING



It is dangerous to open the door mid-cycle, as hot steam may scald you.

Auto Open

After washing, the door will open automatically to achieve better drying effect.

💡 NOTE:

The dishwasher door must not be blocked when set to open automatically. This can disrupt door lock functionality.



USING YOUR DISHWASHER



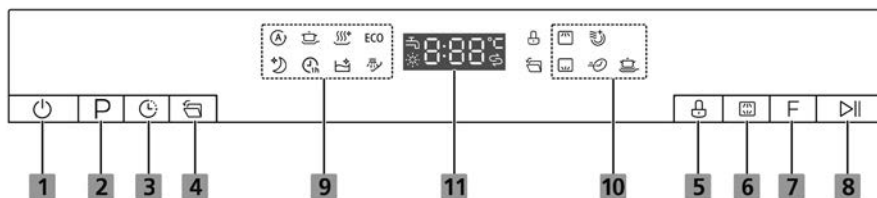





Control Panel













Operation (Button)

1 Power	Press this button to turn on your dishwasher.
2 Program	Press this button to select the appropriate washing program, corresponding indicator will be lit.
3 Delay	Press this button to set the delayed hours for washing. You can delay the start of washing up to 24 hours. One press on this button delays the start of washing by one hour.
4 Auto open	When selected, the dishwasher door opens automatically at the end of the program, which improves the drying results. This function is selected by default.
5 Child lock	This option allows you to lock the buttons on the control panel, so children cannot accidentally start the dishwasher by pressing the buttons on the panel. Only the Power button remains active.
6 Alt	Press the button to select either upper basket or lower basket loaded, and the corresponding indicator will light up.
7 Function	Press the button to select a function, corresponding indicator will be lit.
8 Start/Pause	Press the button to start the selected washing program or pause the working program.

Display

9 Program	<p> Auto Auto sensing wash, lightly, normally or heavily soiled crockery, with or without dried-on food.</p> <p> Intensive For the heaviest soiled crockery, and normally soiled pots, pans, dishes etc. With dried-on food.</p> <p> Hygiene Use to sanitize your dishes and glassware. Maintains the water temperature at 72°C.</p> <p>ECO ECO This is the standard program suitable for normally soiled loads, such as pots, plates, glasses and lightly soiled pans.</p> <p> Whisper Lower noise and normally energy consumption, used for washing in evening.</p> <p> 1 hour For normally soiled loads that need quick wash.</p> <p> Self-Cleaning This program provides an effective cleaning of the dishwasher itself.</p> <p> Soak To rinse dishes that you plan to wash later that day.</p>
10 Function	<p> Upper When you select Upper, only the upper rack nozzle is activated. The lower nozzle will not operate.</p> <p> Lower When you select Lower, only the lower rack nozzle is activated. The upper nozzle will not operate.</p>

Display

10 Function	<p> Extra Drying For better drying result. (It can only be used with Intensive, Hygiene, ECO, Whisper, 1 hour)</p> <p> Express Reduce the program time. (It can only be used with Intensive, Hygiene, ECO, Whisper, 1 hour)</p> <p> Power Wash To wash very dirty, hard to clean dishes. (It can only be used with Intensive, Hygiene, ECO, Whisper, 1 hour)</p>
11 Screen	<p> Water Faucet If the “” indicator is lit, it means the water faucet closed.</p> <p> Rinse Aid If the “” indicator is lit, it means the dishwasher is low on dishwasher rinse aid and requires a refill.</p> <p> Salt If the “” indicator is lit, it means the dishwasher is low on dishwasher salt and needs to be refilled.</p> <p> 0:00° To show the reminding time, temperature, delay time, error code etc.</p>

Water Softener

The water softener must be set manually, using the water hardness dial.

The water softener is designed to remove minerals and salts from the water, which would have a detrimental or adverse effect on the operation of the appliance.

The more minerals there are, the harder your water is.

The softener should be adjusted according to the hardness of the water in your area.

Your local Water Authority can advise you on the hardness of the water in your area.

Adjusting salt consumption

The dishwasher is designed to allow for adjustment in the amount of salt consumed based on the hardness of the water used. This is intended to optimise and customise the level of salt consumption.

Please follow the steps below for adjustment in salt consumption.

1. Close the door and switch on the appliance;
2. Press the Program button for more than 5 seconds to start the water softener set model within 60 seconds after press the Power button ;
3. Press the Program button to select the proper set according to your local environment, the sets will change in the following sequence:
H3->H4->H5->H6->H1->H2->H3;
4. Without operation in 5 seconds or press the Power button to complete the setup and exit the setup mode.

WATER HARDNESS				Water softener level	Salt consumption (gram/cycle)
German °dH	French °fH	British °Clarke	Mmol/l		
0 - 5	0 - 9	0 - 6	0 - 0.94	H1	0
6 - 11	10 - 20	7 - 14	1.0 - 2.0	H2	9
12 - 17	21 - 30	15 - 21	2.1 - 3.0	H3	12
18 - 22	31 - 40	22 - 28	3.1 - 4.0	H4	20
23 - 34	41 - 60	29 - 42	4.1 - 6.0	H5	30
35 - 55	61 - 98	43 - 69	6.1 - 9.8	H6	60

1°dH=1.25 °Clarke=1.78 °fH=0.178mmol/l

The manufactory setting: H3

Contact your local water board for information on the hardness of your water supply.

NOTE:

Water Softener

The hardness of the water varies from place to place. If hard water is used in the dishwasher, deposits will form on the dishes and utensils.

The appliance is equipped with a special softener that uses a salt container specifically designed to eliminate lime and minerals from the water.

Preparing And Loading Dishes

- Consider buying utensils which are identified as dishwasher-proof.
- For particular items, select a program with the lowest possible temperature.
- To prevent damage, do not take glass and cutlery out of the dishwasher immediately after the program has ended.

For washing the following cutlery/dishes

Are not suitable

- Cutlery with wooden, horn china or mother-of-pearl handles
- Plastic items that are not heat resistant
- Older cutlery with glued parts that are not temperature resistant
- Bonded cutlery items or dishes
- Pewter or cooper items
- Crystal glass
- Steel items subject to rusting
- Wooden platters
- Items made from synthetic fibres

Are of limited suitability

- Some types of glasses can become dull after a large number of washes
- Silver and aluminum parts have a tendency to discolor during washing
- Glazed patterns may fade if machine washed frequently

Recommendations for loading the dishwasher

Scrape off any large amounts of leftover food. Soften remnants of burnt food in pans. It is not necessary to rinse the dishes under running water.

For best performance of the dishwasher, follow these loading guidelines.

Place objects in the dishwasher in following way:

- Items such as cups, glasses, pots/pans, etc. are faced downwards.
- Curved items, or ones with recesses, should be loaded aslant so that water can run off.
- All utensils are stacked securely and can not tip over.
- All utensils are placed in the way that the spray arms can rotate freely during washing.
- Load hollow items such as cups, glasses, pans etc. With the opening facing downwards so that water cannot collect in the container or a deep base.
- Dishes and items of cutlery must not lie inside one another, or cover each other.
- To avoid damage, glasses should not touch one another.
- The upper basket is designed to hold more delicate and lighter dishware such as glasses, coffee and tea cups.
- Long bladed knives stored in an upright position are a potential hazard!
- Long and / or sharp items of cutlery such as carving knives must be positioned horizontally in the upper basket.
- Please do not overload your dishwasher. This is important for good results and for reasonable consumption of energy.

NOTE:

Very small items should not be washed in the dishwasher as they could easily fall out of the basket.

Removing the dishes

To prevent water dripping from the upper basket into the lower basket, we recommend that you empty the lower basket first, followed by the upper basket.

WARNING



Items will be hot! To prevent damage, do not take glass and cutlery out of the dishwasher for around 15 minutes after the program has ended.

Loading the upper basket

The upper basket is designed to hold more delicate and lighter dishware such as glasses, coffee and tea cups and saucers, as well as plates, small bowls and shallow pans (as long as they are not too dirty). Position the dishes and cookware so that they will not get moved by the spray of water.



Loading the lower basket

We suggest that you place large items and the most difficult to clean items are to be placed into the lower basket: such as pots, pans, lids, serving dishes and bowls, as shown in the figure below. It is preferable to place serving dishes and lids on the side of the racks in order to avoid blocking the rotation of the top spray arm.

The maximum diameter advised for plates in front of the detergent dispenser is of 19 cm, this not to hamper the opening of it.

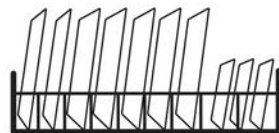

Loading the cutlery basket

Cutlery should be placed in the cutlery rack separately from each other in the appropriate positions, and do make sure the utensils do not nest together, this may cause bad performance.

⚠ WARNING



Do not let any item extend through the bottom.

Always load sharp utensils with the sharp point down!

Function Of The Rinse Aid And Detergent

The rinse aid is released during the final rinse to prevent water from forming droplets on your dishes, which can leave spots and streaks. It also improves drying by allowing water to roll off the dishes. Your dishwasher is designed to use liquid rinse aids.

⚠ WARNING

Only use branded rinse aid for dishwasher. Never fill the rinse aid dispenser with any other substances (e.g. Dishwasher cleaning agent, liquid detergent). This would damage the appliance.

When to refill the rinse aid

The regularity of the dispenser needing to be refilled depends on how often dishes are washed and the rinse aid setting used.

- The Low Rinse Aid indicator () will be lit when more rinse aid is needed.
- Do not overfill the rinse aid dispenser.

Function of detergent

The chemical ingredients that compose the detergent are necessary to remove, crush and dispense all dirt out of the dishwasher. Most of the commercial quality detergents are suitable for this purpose.

⚠ WARNING

- Proper Use of Detergent

Use only detergent specifically made for dishwashers use. Keep your detergent fresh and dry.

Don't put powdered detergent into the dispenser until you are ready to wash dishes.



Dishwasher detergent is corrosive! Keep dishwasher detergent out of the reach of children.

Filling The Rinse Aid Reservoir

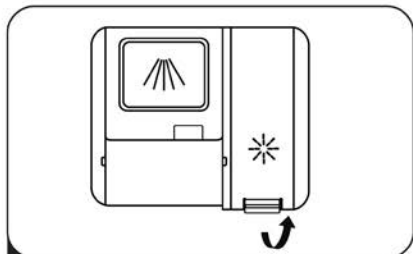

- 1 Remove the rinse reservoir cap by lifting up the handle .

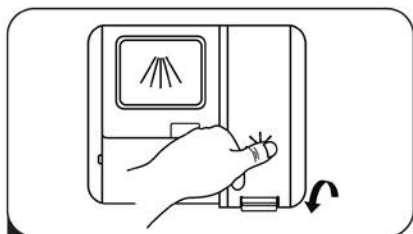

- 3 Close the cap after all.

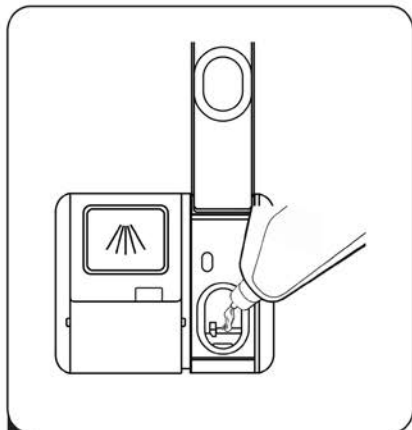

- 2 Pour the rinse aid into the dispenser, being careful not to overfill.

Adjusting the rinse aid reservoir

To achieve a better drying performance with limited rinse aid, the dishwasher is designed to adjust the consumption by user. Follow the below steps.

1. Close the door and switch on the appliance.
2. Within 60 seconds after step 1, press the Program button more than 5 seconds, and then press the Delay button to enter the set model, the rinse aid indication blinks as 1Hz frequency.
3. Press the Program button to select the proper set according to your using habits, the sets will change in the following sequence: d3->d4->d5->d1->d2->d3. The higher the number, the more rinse aid the dishwasher uses.
4. Without operation in 5 seconds or press the Power button to complete the setup and exit the setup mode.

Filling The Detergent Dispenser

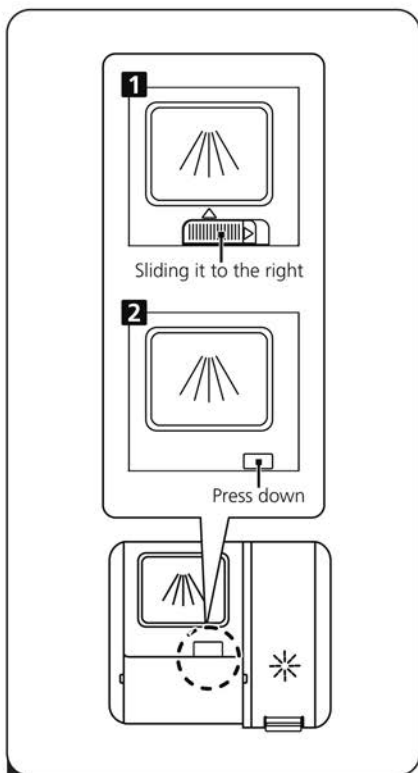

1 Please choose an open way according to the actual situation.

1. Open the cap by sliding the release catch.
2. Open the cap by pressing down the release catch.

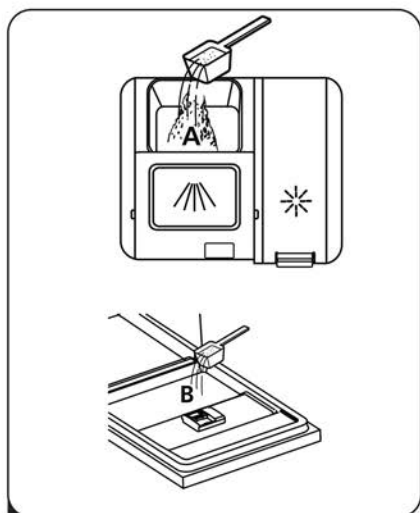

- 2 Add detergent into the larger cavity (A) for the main wash cycle . For better cleaning result, especially if you have very dirt items, pour a small amount of detergent onto the door. The additional detergent will activate during the pre-wash phase.

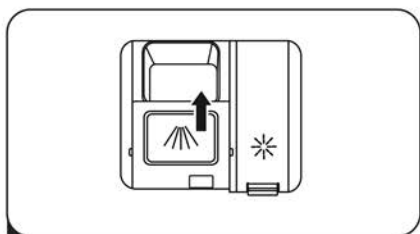

- 3 Close the flap by sliding it to the front and then pressing it down.





NOTE:



- Be aware that depending on the soiling of water, setting may be different.
- Please observe the manufacturer's recommendations on the detergent packaging.

Wash Cycle Table

The table below shows which programs are best for the levels of food residue on them and how much detergent is needed. It also show various information about the programs.

(●)Means: need to fill rinse into the Rinse-Aid Dispenser.

Program	Description Of Cycle	Detergent Pre/Main	Running Time(min)	Energy (kWh)	Water (L)	Rinse Aid
 Auto	Prewash(45°C) Wash(55-65°C) Rinse Rinse(50-55°C) Drying	$\frac{4/14g}{1 \text{ or } 2 \text{ pieces}}$	85-150	0.615-1.201	9.2-13.9	●
 Intensive	Prewash(50°C) Wash(65°C) Rinse Rinse Rinse(60°C) Drying	$\frac{4/14g}{1 \text{ or } 3 \text{ pieces}}$	205	1.129	14.1	●
 Hygiene	Prewash(50°C) Wash(72°C) Rinse Rinse Rinse(72°C) Drying	$\frac{4/14g}{1 \text{ or } 3 \text{ pieces}}$	215	1.450	14.5	●
ECO (*EN60436)	Wash(50°C) Rinse Rinse(45°C) Drying	$\frac{18g}{1 \text{ or } 2 \text{ pieces}}$	198	0.674	8.5	●
 Whisper	Prewash(50°C) Wash(60°C) Rinse Rinse Rinse(50°C) Drying	$\frac{4/14g}{1 \text{ or } 3 \text{ pieces}}$	270	0.969	14.1	●

Program	Description Of Cycle	Detergent Pre/Main	Running Time(min)	Energy (kWh)	Water (L)	Rinse Aid
 1 Hour	Wash(55°C) Rinse Rinse(50°C) Drying	$\frac{18\text{g}}{1 \text{ piece}}$	60	0.614	10.0	●
 Self-Cleaning (Maintenance)	Pre-wash(45°C) Wash(70°C) Rinse Rinse(70°C) drying	$\frac{4/14\text{g}}{1\text{or}2 \text{ pieces}}$	145	1.255	13.2	●
 Soak	Soak	/	15	0.018	3.6	○

 **NOTE:**

ECO : This program is the test cycle. The information for comparability test in (*EN60436) accordance with EN60436.

Starting A Cycle Wash

1. Draw out the lower and upper basket, load the dishes and push them back. It is commended to load the lower basket first, then the upper one.
2. Pour in the detergent.
3. Insert the plug into the socket. The power supply refer to last page "Product fiche". Make sure that the water supply is turned on to full pressure.
4. Close the door, press the Power button, to switch on the machine.
5. Choose a program, the response light will turn on. Then press the Start/Pause button, the dishwasher will start its cycle.

Changing The Program Mid-cycle

A wash cycle can only be changed if it has been running for a short time otherwise, the detergent may have already been released and the dishwasher may have already drained the wash water. If this is the case, the dishwasher needs to be reset and the detergent dispenser must be refilled. To reset the dishwasher, follow the instructions below:

1. Press the Start/Pause button to pause the washing.
2. Press Program button for more than 3 seconds - the program will cancel.
3. Press the Program button to select the desired program.
4. Press the Start/Pause button, the dishwasher will start.

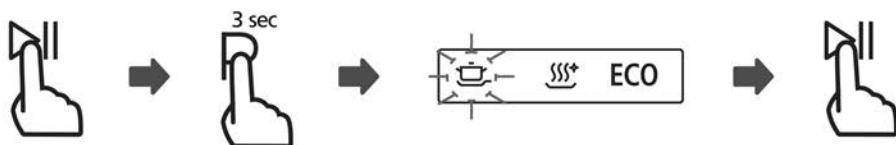

Forget To Add A Dish?

A forgotten dish can be added any time before the detergent dispenser opens. If this is the case, follow the instructions below:

1. Press the Start/Pause button to pause the washing.
2. Wait 5 seconds then open the door.
3. Add the forgotten dishes.
4. Close the door.
5. Press the Start/Pause button, after 10 seconds, the dishwasher will start.



⚠ WARNING



It is dangerous to open the door mid-cycle, as hot steam may scald you.

Auto Open

After washing, the door will open automatically to achieve better drying effect.

💡 NOTE:

The dishwasher door must not be blocked when set to open automatically.
This can disrupt door lock functionality.



ERROR CODES

If there is a malfunction, the dishwasher will display error codes to identify these:

Codes	Meanings	Possible Causes
E1	Longer inlet time.	Faucets is not opened, or water intake is restricted, or water pressure is too low.
E3	Not reaching required temperature.	Malfunction of heating element.
E4	Overflow.	Some element of dishwasher leaks.
E8	Failure of orientation of distributary valve.	Open circuit or break of distributary valve.
Ed	Failure of communication between main PCB with display pcb	Open circuit or break wiring for the communication

WARNING

- If overflow occurs, turn off the main water supply before calling a service.
- If there is water in the base pan because of an overflow or small leak, the water should be removed before restarting the dishwasher.

TROUBLESHOOTING TIPS

Before Calling For Service

Reviewing the charts on the following pages may save you from calling for service.

Problem	Possible Causes	What To Do
Dishwasher doesn't start	Fuse blown, or the circuit break tripped.	Replace fuse or reset circuit breaker. Remove any other appliances sharing the same circuit with the dishwasher.
	Power supply is not turned on.	Make sure the dishwasher is turned on and the door is closed securely. Make sure the power cord is properly plugged into the wall socket.
	Water pressure is low	Check that the water supply is connected properly and the water is turned on.
	Door of dishwasher not properly closed.	Make sure to close the door properly and latch it.
Water not pumped form dishwasher	Twisted or trapped drain hose.	Check the drain hose.
	Filter clogged.	Check the filter system.
	Kitchen sink clogged.	Check the kitchen sink to make sure it is draining well. If the problem is the kitchen sink that is not draining , you may need a plumber rather than a serviceman for dishwashers.
Foam in the tub	Wrong detergent.	Use only the special dishwasher detergent to avoid suds. If this occurs, open the dishwasher and let suds evaporate. Add 1 liter of cold water to the bottom of the dishwasher. Close the dishwasher door, then select any cycle. Initially, the dishwasher will drain out the water. Open the door after draining stage is complete and check if the suds have disappeared.

Problem	Possible Causes	What To Do
	Spilled rinse aid.	Always wipe up rinse aid spills immediately.
Stained tub interior	Detergent with colourant may have been used.	Make sure that the detergent has no colourant.
White film on inside surface	Hard water minerals.	To clean the interior, use the damp soft cloth with dishwasher detergent and wear rubber gloves. Never use any other cleaner than dishwasher detergent otherwise, it may cause foaming or suds.
There are rust stains on cutlery	The affected items are not corrosion resistant.	Avoid washing items that are not corrosion resistant in the dishwasher.
	A program was not run after dishwasher salt was added. Traces of salt have gotten into the wash cycle.	Always run a wash program without any crockery after adding salt. Do not select the Turbo function (if present), after adding dishwasher salt.
	The lid of the softer is loose.	Check the softener lid is secure.
Knocking noise in the dishwasher	A spray arm is knocking against an item in a basket	Interrupt the program and rearrange the items which are obstructing the spray arm.
Rattling noise in the dishwasher	Items of crockery are loose in the dishwasher.	Interrupt the program and rearrange the items of crockery.
Knocking noise in the water pipes	This may be caused by on-site installation or the cross-section of the piping.	This has no influence on the dishwasher function. If in doubt, contact a qualified plumber.
The dishes are not clean	The dishes were not loaded correctly.	See PART II "Preparing And Loading Dishes".
	The program was not powerful enough.	Select a more intensive program.

Problem	Possible Causes	What To Do
The dishes are not clean.	Not enough detergent was dispensed.	Use more detergent, or change your detergent.
	Items are blocking the movement of the spray arms.	Rearrange the items so that the spray can rotate freely.
	The filter combination is not clean or is not correctly fitted in the base of wash cabinet. This may cause the spray arm jets to get blocked.	Clean and/or fit the filter correctly. Clean the spray arm jets.
Cloudiness on glassware.	Combination of soft water and too much detergent.	Use less detergent if you have soft water and select a shorter cycle to wash the glassware and to get them clean.
White spots appear on dishes and glasses.	Hard water area can cause limescale deposits.	Check water softener settings or fill status of salt container.
Black or grey marks on dishes	Aluminium utensils have rubbed against dishes	Use a mild abrasive cleaner to eliminate those marks.
Detergent left in dispenser	Dishes block detergent dispenser	Re-loading the dishes properly.
The dishes aren't drying	Improper loading	Use gloves if detergent residue can be found on dishes to avoid skin irritations.
	Dishes are removed too soon	Do not empty your dishwasher immediately after washing. Open the door slightly so that the steam can come out. Take out the dishes until the inside temperature is safe to touch. Unload the lower basket first to prevent the dropping water from the upper basket.

Problem	Possible Causes	What To Do
The dishes aren't drying	Wrong program has been selected.	With a short program, the washing temperature is lower, decreasing cleaning performance. Choose a program with a long washing time.
	Use of cutlery with a low-quality coating.	Water drainage is more difficult with these items. Cutlery or dishes of this type are not suitable for washing in the dishwasher.

⚠ WARNING

Self-repair or non-professional repair may cause serious risks to the safety of the user of the appliance and impact warranty.

TECHNICAL INFORMATION

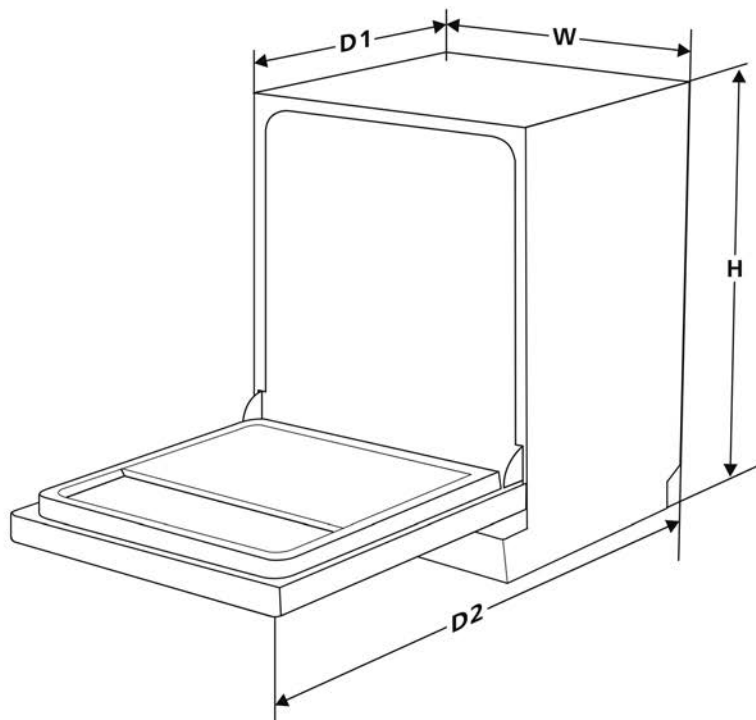

Height (H)	845mm
Width (W)	448mm
Depth (D1)	600mm (with the door closed)
Depth (D2)	1175mm (with the door opened 90°)

Product Information Sheet. Dishwashers

SUPPLIER_NAME_OR_TRADEMARK Dellonda EU Ltd.
 DELEGATED_ACT EU/2019/2017
 MODEL_IDENTIFIER DH166

45cm Slimline Freestanding Dishwasher, 10 Place Settings

ADDRESS Farney Street, Carrickmacross, Co. Monaghan, A81 PK68 Ireland
 PHONE_NUMBER 01284 757 500
 EMAIL_ADDRESS TechnicalCompliance@dellonda.co.uk

Parameter	Verification tolerances		
Rated capacity	10.0	Height	85
		Width	45
		Depth	60
EEL	49.9	Energy efficiency class	D
Cleaning performance index	1.13	Drying performance index	1.07
Energy consumption in kWh [per cycle], based on eco programme using cold water fill.	0.674	Water consumption in litres [per cycle], based on the eco programme	8.5
Programme duration (h:min)	3.18	Design type	Freestanding
Airborne acoustical noise emissions (dB(a) re 1 pW	49	Airborne acoustical noise emission class	C
Off-mode (W)	0.49	Standby mode (W)	NA
Delay start (W) (if applicable)	NA	Standby (W) (if applicable)	NA
		Minimum duration of guarantee (years)	1
Suppliers website	https://www.dellonda.co.uk/		



Environment Protection, Waste Electrical and Waste Electronic Equipment Regulations (WEEE)



Recycle unwanted packaging materials. When this product is no longer required, or has reached the end of its useful life, please dispose of in an environmentally friendly way. Drain any fluids (if applicable) into approved containers, in accordance with local waste regulations. It is our policy to continually improve products and we reserve the right to alter data, specifications and parts without prior notice. No liability is accepted for incorrect use of this product. Guarantee is 12 months from purchase date, proof of which is required for any claim.

Dellonda Limited, Sole UK Distributor of Baridi

Kempson Way, Suffolk Business Park, Bury St Edmunds, Suffolk. IP32 7AR



01284 757575



support@dellonda.co.uk



www.dellonda.co.uk