

baridi

Baridi 60cm Wine Cooler 54 Bottle Undercounter Freestanding Fridge Chiller

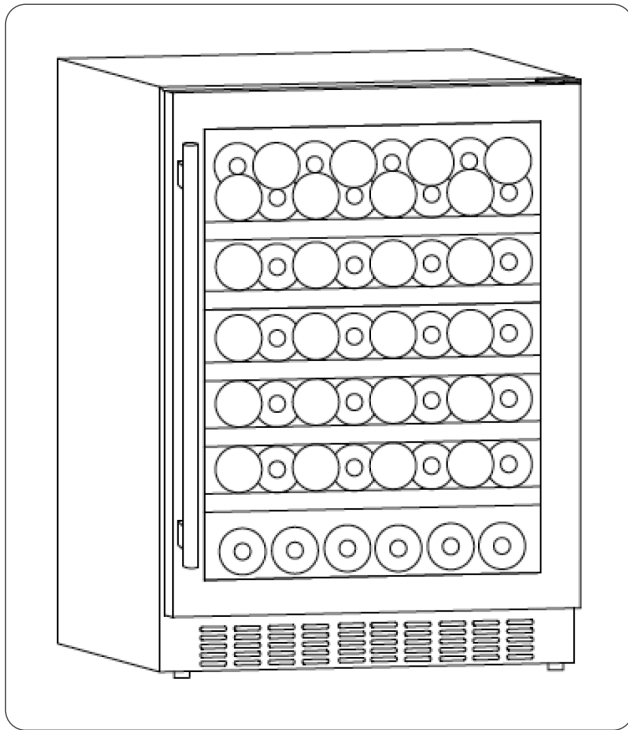

Model No. DH78

Thank you for purchasing a Baridi product from the Dellonda range. Manufactured to a high standard, this product will, if used according to these instructions, and properly maintained, give you years of trouble free performance.

Important Information

Please read these instructions carefully and note any safe operational requirements, warnings & cautions. Use the product correctly and with care for the purpose for which it is intended. Failure to do so may cause damage and/or personal injury and will invalidate the warranty. Keep these instructions safe for future use.



Refer to
instructions



Indoor use
only

• ELECTRICAL SAFETY

- **WARNING!** It is the user's responsibility to check the following:
 - Check all electrical equipment and appliances to ensure that they are safe before using. Inspect power supply leads, plugs and all electrical connections for wear and damage. Dellonda recommend that an RCD (Residual Current Device) is used with all electrical products. You may obtain an RCD by contacting your local domestic stockist. If the product is used in the course of business duties, it must be maintained in a safe condition and routinely PAT (Portable Appliance Test) tested.
- **Electrical safety information:** It is important that the following information is read and understood.
 - Ensure that the insulation on all cables and on the appliance is safe before connecting it to the power supply.
 - Regularly inspect power supply cables and plugs for wear or damage and check all connections to ensure that they are secure.
 - **Important:** Ensure that the voltage rating on the appliance suits the power supply to be used and that the plug is fitted with the correct fuse - see fuse rating in these instructions.
 - **DO NOT** pull or carry the appliance by the power cable.
 - **DO NOT** pull the plug from the socket by the cable.
 - **DO NOT** use worn or damaged cables, plugs or connectors.
 - Ensure that any faulty item is repaired or replaced immediately by a qualified electrician.

This product is fitted with a BS1363/A 13 Amp

- 3 pin plug. If the cable or plug is damaged during use, switch off the electricity supply and remove from use. Ensure that repairs are carried out by a qualified electrician.
- Replace a damaged plug with a BS1363/A 13 amp 3 pin plug. If in doubt contact a qualified electrician.

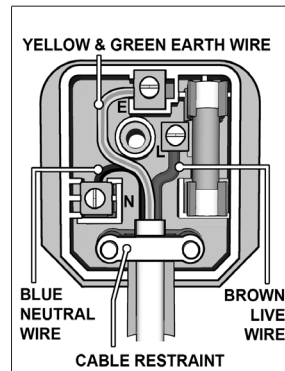

Replacement fuse rating:
13A

- Connect the GREEN/YELLOW earth wire to the earth terminal 'E'.
- Connect the BROWN live wire to the live terminal 'L'.
- Connect the BLUE neutral wire to the neutral terminal 'N'.

- Ensure that the cable outer sheath extends inside the cable restraint and that the restraint is tight.
- Dellonda recommend that repairs are carried out by a qualified electrician.

• GENERAL SAFETY

- **DO NOT** store explosive substances such as aerosol cans with a flammable propellant in this appliance.
- **WARNING:** Ensure the supply cord is not trapped or damaged.

- **WARNING: DO NOT** locate multiple portable socket-outlets or portable power supplies at the rear of the appliance.
- This appliance is intended to be used in household and similar applications such as staff kitchen areas in shops, offices and other working environments; holiday homes, hotels and other residential settings; and catering and similar non-retail applications.
- This appliance can be used by children aged from 8 years and above and persons with reduced physical, sensory or mental capabilities or lack of knowledge and experience if they have been given supervision or instruction concerning the use of the appliance in a safe way and understand the hazards involved. Children shall not play with the appliance. Cleaning and user maintenance shall not be made by children without supervision.

• INTRODUCTION

- Add style to your kitchen with this 60cm slim built-under wine cooler! Fits under standard height worktops and door at the perfect height to sit above standard height kick plates. Digital temperature control between 5-20°C allowing you to chill up to 54 bottles of wine to the perfect temperature. Reversible door and adjustable feet. Stylish stainless steel door handle, wooden shelves and internal LED light. Super quiet compressor cooling with a noise level of just 41dB.

• SPECIFICATION

- **Model no:** **DH78**
- Capacity: 54 bottle
- Volume: 135L
- Temperature range: 5-20°C
- Supply: 230V
- Frequency: 50Hz
- Rated current: 0.8A
- Energy consumption: 92KWh/annum
- Energy efficiency class: G
- Noise level: 41dB
- Dimensions: 595 x 570 x 820mm
- Refrigerant R600a (35g)
- Gas: Cyclopentane
- Cable length 1.5m

• PRODUCT DESCRIPTION

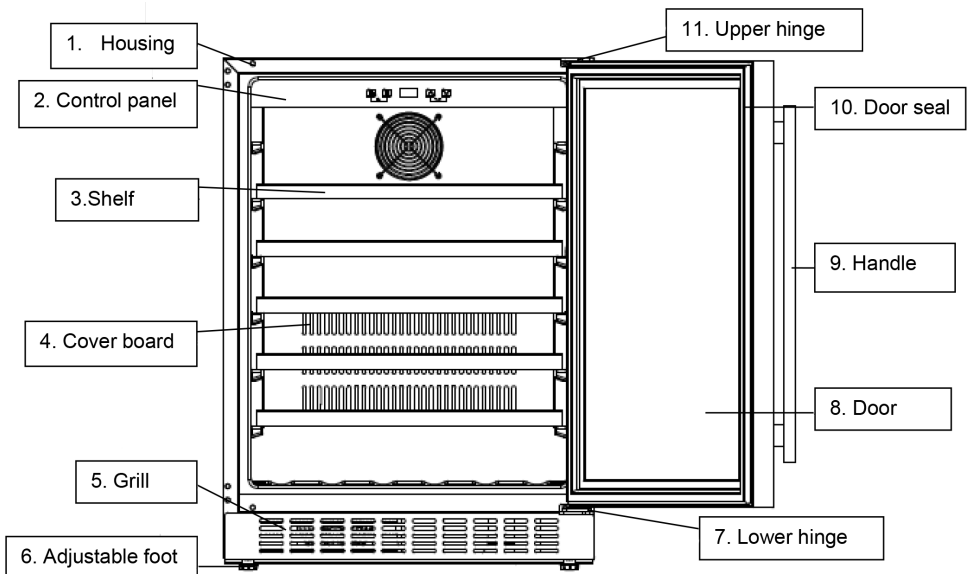

• DOOR HANDLE ASSEMBLY

- The door handle is supplied unattached and will require assembling onto the door.

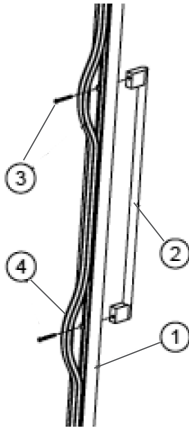

- 1) Gently pull the door seal away from the door behind the location of the handle screw holes.
- 2) Line up the handle on the face of the door
- 3) Pass the screws through the door and screw them into the handle.
- 4) Tighten the screws and carefully push the seal fully back into the door channel.

• INSTALLATION

- The unit is designed to be free-standing. Ventilation Space - a minimum space of 50mm is required for the rear of the fridge and 30mm for the top and both sides. This will maximise the efficiency, performance and the life of the fridge and also ensure that there is sufficient space for the hinge to operate effectively.
- Locate the unit away from direct sunlight or sources of heat i.e. radiator, stove etc. Extreme or cold ambient temperatures may also prevent the unit working effectively.
- **DO NOT** locate the unit in a damp location.
- Ensure that the floor surface is strong and stable enough to support the unit when it is fully loaded.
- Level the unit when in location by using the adjustable levelling feet in each corner.
- Once in position allow the unit to rest for an hour before turning it on.

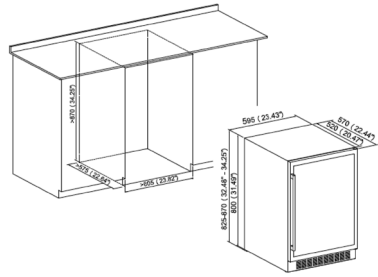

• REVERSING THE DOOR HINGE

- Your chiller is supplied hinged on the right as you view it, if you want to reverse the door follow the sequence below.

1)

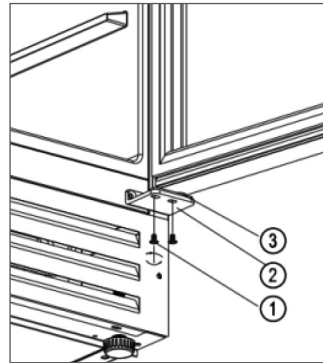

- Open the door to 90° and hold it steady. Unscrew the lower hinge screws (1+2) from the pivot bracket (3).

2)

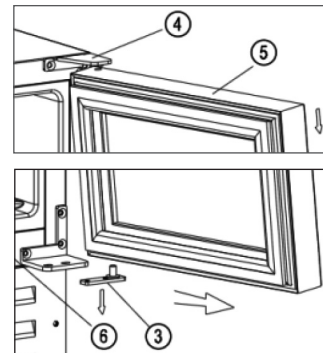

- Pull the base of the door away (arrow) until it clears the bottom hinge (3) and drop the door slightly to release from the top hinge plate (4). Lift the door away from fridge unit.

3)

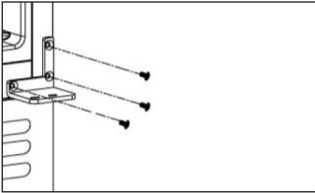
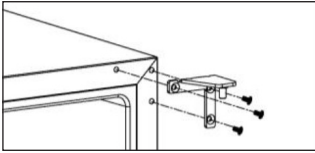

- Unscrew the top and bottom hinge mounting plates from the face of the chiller (retain these should you need to change the hinge back at a later date).

4)

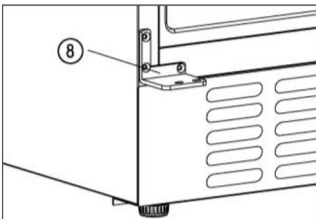
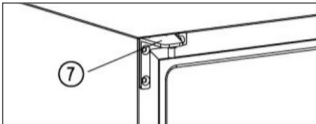

- Take the new (left hand) hinge mounting brackets and screw them to the left side upper and lower mounting locations as shown (7+8) as supplied with the unit.
- Rotate the chiller door through 180°, lift the door with the hinge pin into the top hinge bracket.
- Slide the lower hinge pin into the door and carefully lift the base of the door onto the lower mounting bracket lining up the fixing holes as you go.
- Screw the two lower hinge fixing screws in place.

- The door will now hinge from the opposite side.

• OPERATION

- **Starting Operation**, Before you turn on your chiller ensure the cabinet has been cleaned.
- Allow the installed chiller to stand for at least 1 hour prior to use.
- Check around the unit for damage.
- Ensure the unit is level, all feet adjusted correctly and taking the weight evenly.
- When powered up the chiller should chill within 1 hour, if not check the power supply.

• Control Panel

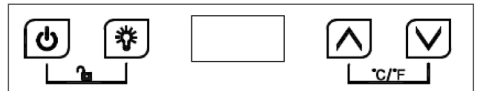

- **Lock/Unlock**
- The unit will be in lock mode when turned on.
- Press and hold the On/Off and Light buttons simultaneously for 3 seconds to unlock.
- Repeat this if you want to engage the child lock mode.

- **On/Off** 
- Press and hold for 3 seconds to release from stand by mode
- Press and hold for 3 seconds to go into stand by mode.

- **Light** 
- Press the light switch to turn the lights in the chiller on or off (this function does not work in stand by mode).

- **Up** 
- Press the Up key once and the display will show the current SET temperature
- Keep pressing to increase the current SET temperature. (1 press = 1°C increase).
- The new SET temperature will flash for 5 seconds and then return to the current temperature in the chiller.

- **Down**



- Press the Up key once and the display will show the current set temperature
- Keep pressing to decrease the current set temperature. (1 press = 1°C decrease).
- The new set temperature will flash for 5 seconds and then return the current temperature in the chiller.

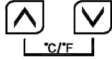

- **Temperature display**

- Switch from Celsius to Fahrenheit by pressing and holding down the Up and Down arrows simultaneously for 3 seconds.
- **Loading capacity**

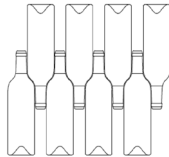
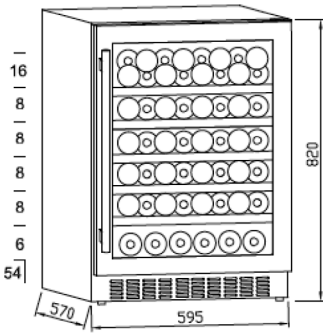

- The capacity of the chiller will vary based on arrangement along with different bottle shapes and sizes
- Each shelf is designed to accept 1 layer of wine bottles.
- Shelves slide out part way to make loading easier. (Ensure the door is fully open)

- **Suggested settings**

- Red Wine15-18°C
- White wine 9-14°C
- Rose wine 10-11°C
- Champagne 5-8°C

- **Attention**



- The default factory setting for the chiller is 12° C.
- The chiller temperature can be set between 5-20°C.
- If a malfunction occurs an audible alarm will sound, press any key on the keypad to turn the alarm off.
- If the temperature sensor fails in the chiller error code **E1** will show on the display for an open circuit and **E2** will show for a short circuit.
- When the defrost sensor fails the error code **E3** will show for an open circuit and **E4** for a short circuit.
- Try to use the shelf in front of the fan last to help with airflow.

- **MAINTENANCE**

- Remove the power plug from the supply when performing cleaning or maintenance.
- **DO NOT** use abrasive or chemical cleaning materials on any surface of the unit.
- Wipe interior and exterior surfaces with a damp cloth and dry thoroughly with a clean dry cloth.
- For more soiled surfaces use a neutral detergent, wipe down with a clean damp cloth and dry thoroughly with a clean dry cloth.
- It is recommended that the appliance be turned off if not being used.

Troubleshooting

Symptom	Solution
Unit does not operate.	Not plugged in. Fuse/circuit breaker failure. The compressor will restart 5 minutes after a power break.
Turns on and off frequently. Poor cooling.	Room temperature higher than normal. Door opened too often. Door not properly closed. Temperature control incorrectly set. Door gasket not sealing. Not enough space around unit.
Compressor runs continuously	If the chiller is not cooling call after sales service.
Vibrations	Check to assure unit is level. Ensure the unit is correctly spaced on all sides.
Noisy unit	Contraction/expansion of panels. Unit not level or feet need adjusting. Check fan operation. Check heat pump.
Door will not close properly	Unit not level. Door gasket distorted. Internals out of position.



Environment Protection, Waste Electrical and Waste Electronic Equipment Regulations (WEEE)



Recycle unwanted packaging materials. When this product is no longer required, or has reached the end of its useful life, please dispose of in an environmentally friendly way. Drain any fluids (if applicable) into approved containers, in accordance with local waste regulations. It is our policy to continually improve products and we reserve the right to alter data, specifications and parts without prior notice. No liability is accepted for incorrect use of this product. Guarantee is 12 months from purchase date, proof of which is required for any claim.

Dellonda Limited, Sole UK Distributor of Baridi

Kempson Way, Suffolk Business Park, Bury St Edmunds, Suffolk. IP32 7AR



01284 757575



support@dellonda.co.uk



www.dellonda.co.uk