

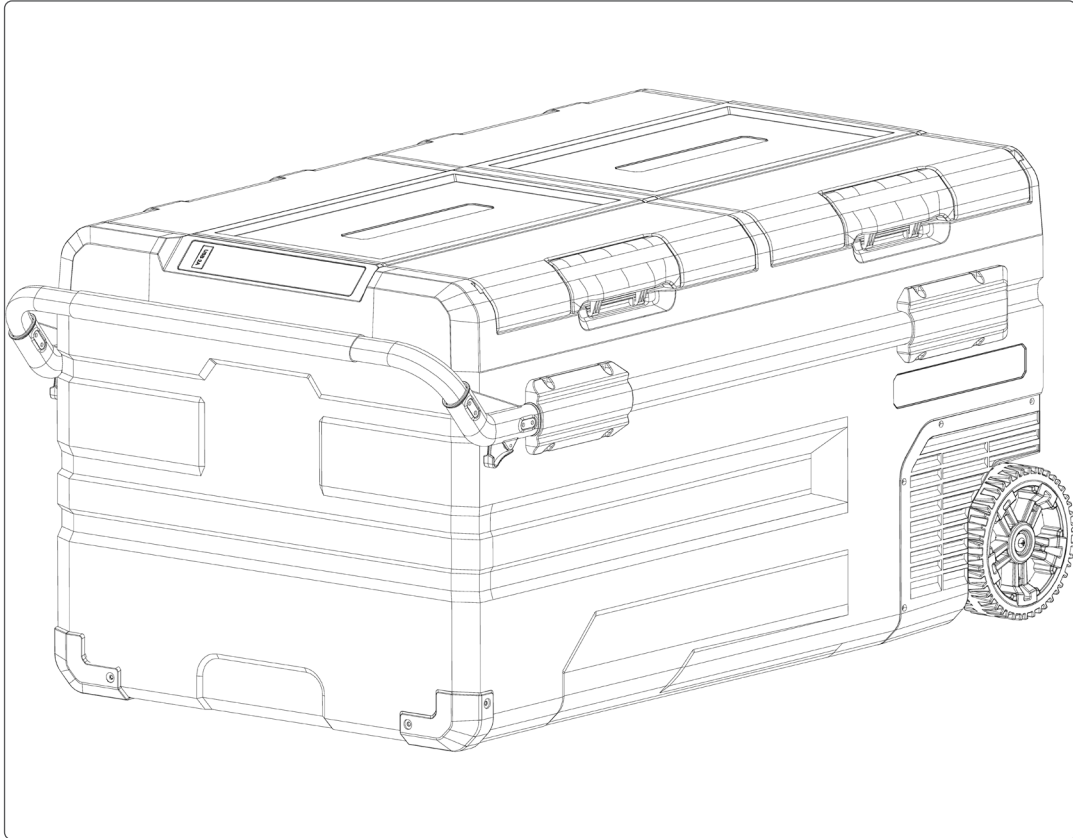

75L/95L Portable Car Fridge, Freezer, 12/24V Dual Zone Compressor



Model No. DL127, DL128

Thank you for purchasing a Dellonda product. Manufactured to a high standard, this product will, if used according to these instructions, and properly maintained, give you years of trouble free performance.

Important Information

Please read these instructions carefully. Note the safe operational requirements, warnings & cautions. Use the product correctly and with care for the purpose for which it is intended. Failure to do so may cause damage and/or personal injury and will invalidate the warranty. Keep these instructions safe for future use.



Refer to
instruction
manual



Keep Unit Dry

SAFETY INSTRUCTIONS

• ELECTRICAL SAFETY

- **WARNING!** It is the user's responsibility to check the following:
- Check all electrical equipment and appliances to ensure that they are safe before using. Inspect power supply leads, plugs and all electrical connections for wear and damage. Dellonda recommend that an **RCD** (Residual Current Device) is used with all electrical products. You may obtain an **RCD** by contacting your local domestic appliance stockist.
- If the product is used in the course of business duties, it must be maintained in a safe condition and should be routinely **PAT** (Portable Appliance Test) tested.
- Electrical safety information: It is important that the following information is read and understood.
- Ensure that the insulation on all cables and on the appliance is safe before connecting it to the power supply.
- Regularly inspect power supply cables and plugs for wear or damage and check all connections to ensure that they are secure.
- Important: Ensure that the voltage rating on the appliance suits the power supply to be used and that the plug is fitted with the correct fuse - see fuse rating in these instructions.
- **DO NOT** pull or carry the appliance by the power cable.
- **DO NOT** pull the plug from the socket by the cable.
- **DO NOT** use worn or damaged cables, plugs or connectors.
- Ensure that any faulty item is repaired or replaced immediately by a qualified electrician.
- Dellonda recommend that repairs are carried out by a qualified electrician.
- Modern vehicles contain extensive electronic systems. You are required to check with the vehicle manufacturer, for any specific instructions regarding the use of this type of equipment on each vehicle. No liability will be accepted for damage/injury, where this product is not used in accordance with all instructions.

• GENERAL SAFETY

- **DO NOT** operate the appliance if it is visibly damaged.
- **DO NOT** poke, or allow anything to get into the ventilation openings.
- **DO NOT** expose the appliance to rain or soak it in water.
- **DO NOT** place the appliance near naked flames or other heat sources (heaters, direct sunlight, gas ovens etc.)
- **DO NOT** store any explosive substances like spray cans with a flammable propellant in the product.
- Ensure the supply cord is dry and not trapped or damaged.
- Check the voltage specification on the type plate corresponds to that of the energy supply.
- The appliance is only to be used with the power supply unit provided with the appliance. Do not use electrical appliances inside the food storage compartments of the appliance, unless they are of the type recommended by the manufacturer.
- Once unpacked and before turning on, the appliance must be placed on a level surface for at least 6 hours.
- Make sure that the appliance stays horizontal when it is running. The tilt angle must be less than 5° for normal use and be less than 45° only for a short period of time.
- Keep the ventilation openings in the unit casing or in the built-in structure free of obstacles.
- Keep the appliance stable on the ground or in the car. **DO NOT** drain upside down.
- Repairs may only be carried out by qualified personnel.
- Only use the power leads supplied with the product.
- Children shall not play with the appliance. Cleaning and user maintenance shall not be made by children without supervision.
- The appliance can be used by children aged from 8 years and above and persons with reduced physical, sensory or mental capabilities or lack of experience and knowledge if they've been given supervision or instruction concerning use of the device in a safe way and understand the hazards.
- Risk of child / animal entrapment. Before you throw away your old refrigerator or freezer: take off the doors: leave the shelves in place so that children / animals may not easily climb inside.
- Check if the cooling capacity of the appliance is suitable for storing the food or anything else placed in the product.
- Food may only be stored in its original packaging or in suitable containers.
- If the appliance is left empty for long periods, switch off, defrost, clean, dry, and leave the door open to prevent mould developing within the appliance.
- The appliance is intended to be used in household and similar applications such as: Staff kitchen areas in shops, offices and other working environments such as camping, farm houses and by clients in hotels, motels and other residential environments; bed and breakfast type environments; catering and similar non-retail applications.
- Please follow local regulations regarding disposal of the appliance for its refrigerant.

STRUCTURE

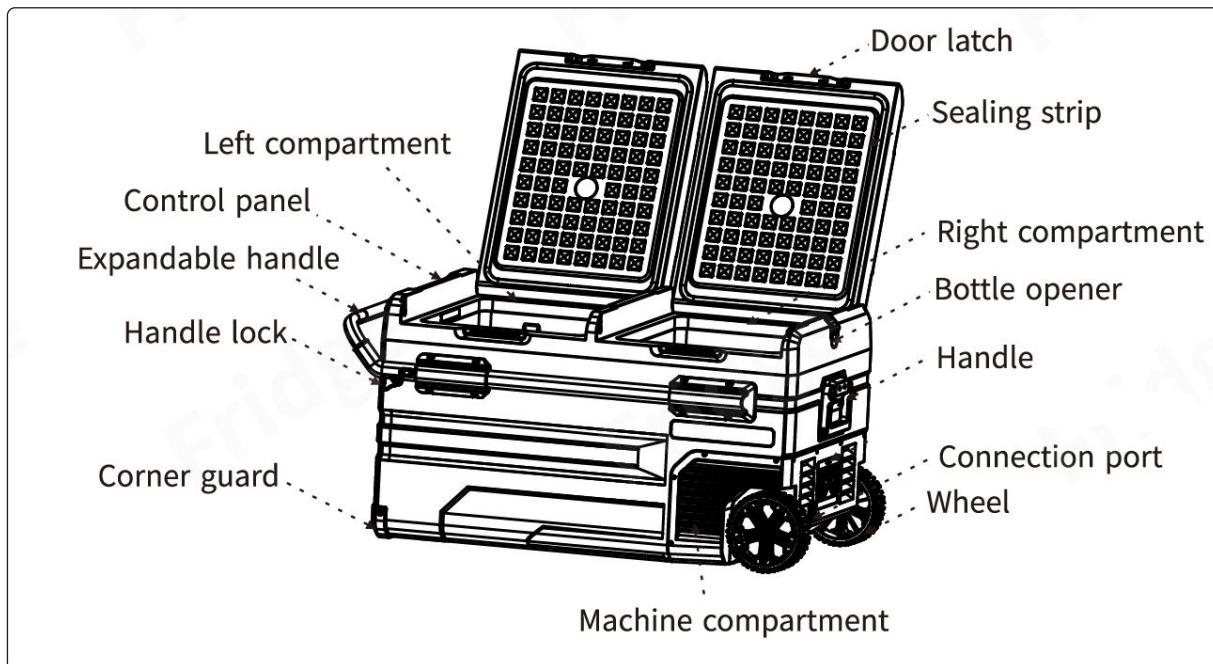

REVERSE DOOR OPENING DIRECTION

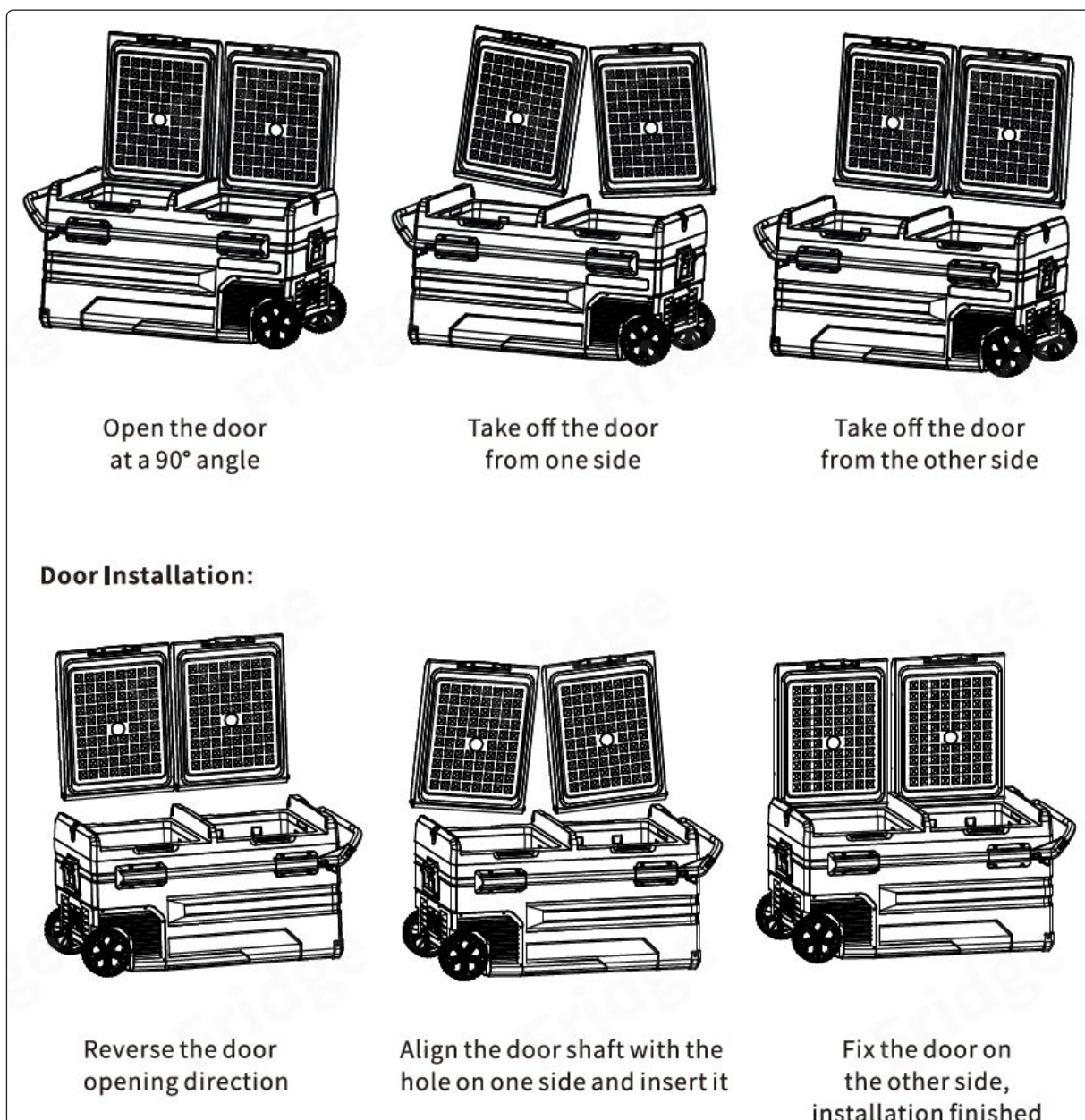





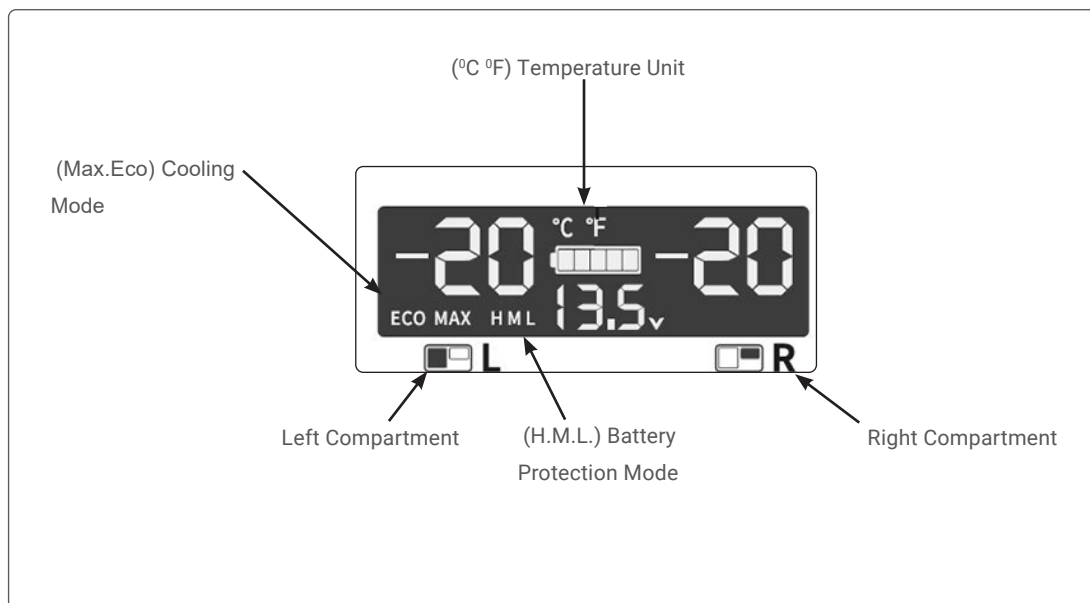
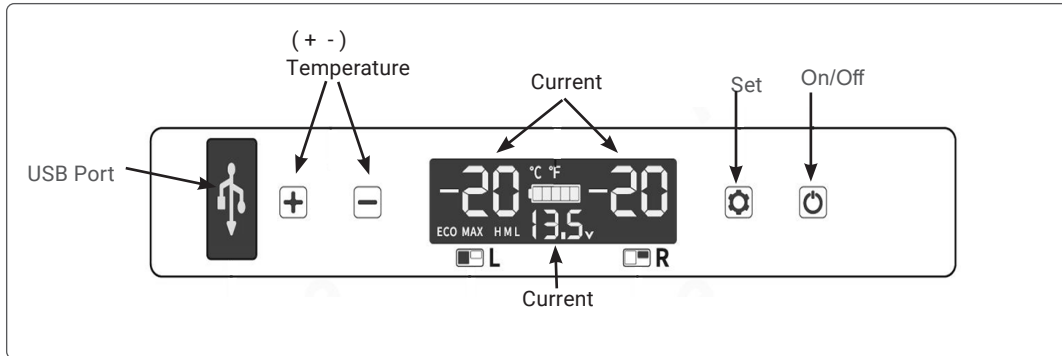

SPECIFICATION

	DL127	DL128
Capacity	75L	95L
Internal Dimensions Left (W x D x H)	325 x 385 x 355mm	355 x 420 x 355mm
Internal Dimensions Right (Max.) (W x D x H)	325 x 385 x 355mm	355 x 420 x 355mm
Power Consumption	95kWh/a	98kWh/a
Power Rating	80W	80W
Product Dimensions (W x D x H)	975 x 535 x 465mm	1005 x 570 x 465mm
Refrigerant	R600a	R600a
Temperature Range	-20°C to +20°C	-20°C to +20°C







OPERATION



- **POWER SUPPLY:** connect to DC12V/24V power, AC100~240V power (230V adaptor available separately, Model No. DL129).
 - **DISPLAY SCREEN INITIALIZATION:** when connected to the power supply, the buzzer will make a long beep, and the display will be on for two seconds then enter the standby mode.
 - **POWER ON/OFF:** press On/Off to switch **ON**, long press On/Off for three seconds to switch **OFF**.
 - **TEMPERATURE SETTING:** under the running state, long press + and  at the same time for three seconds to switch **ON/OFF** the left compartment. Long press - and  at the same time for three seconds to switch **ON/OFF** the right compartment. Two compartments cannot be switched off at the same time. When both left and right compartments are set in running state, press + or - to enter left compartment setting. Press + to increase temperature, and - to decrease temperature. Press  to switch left/right compartment. The setting will be saved after stop operating for four seconds (Note: the temperature displayed is the current temperature of the compartments. It'll take a while to reach the set temperature).
- Temperature setting range: 20°C to +20°C
- **COOLING MODE:** When the product is running, press  to switch between **MAX** (fast cooling) and **ECO** (Energy saving Mode). (*Factory setting is **MAX**.)
 - **BATTERY PROTECTION MODE:** When the product is running, long press  for three seconds until screen flashes, then press  again to select protection mode H (High), M (Medium) and L (Low).
 - Voltage reference is as overleaf.

MODE \ INPUT	DC 12V		DC 24V	
	CUT OUT	CUT IN	CUT OUT	CUT IN
L	8.5V	10.9V	21.3V	22.7V
M	10.1V	11.4V	22.3V	23.7V
H	11.1V	12.4V	24.3V	25.7V

- **TEMPERATURE UNIT SETTING:** switch off the fridge, long press  for three seconds until E1 displays, then switch to E5 by pressing 

					
Drinks	Fruits	Vegetable	Delicatessen	Ice cream	Meat
5°C/41°F	5~8°C/41~46°F	3~10°C/37~50°F	4°C/39°F	-10°C/14°F	-18°C/0°F

MAINTENANCE

- **CLEANING:**
- **WARNING:** Switch off and unplug the device first to avoid electric shock.
- Use wet cloth to clean the device and dry it.
- **DO NOT** soak the fridge in water and do not wash it directly.
- **DO NOT** use abrasive cleaning agents during cleaning as these can damage the device.
- **STORAGE:**
- If the device will not be in use for a long time, please:
 - Switch off and unplug the device.
 - Take out all the items stored in the device.
 - Wipe off excess water with a soft cloth.
 - Put the fridge in a cool and dry place.
 - Leave the lid slightly open to prevent odours from forming.
 - Recommended storage environment: ambient temperature: 25°C, ambient humidity: equal to or less than 75%.
- **DEFROSTING:**
- Humidity can form frost in the interior of the cooling device or on the evaporator. This reduces the cooling capacity. Defrost the device in good time to avoid this.
- Switch off and unplug the device first to avoid electric shock.
- Take out all the items stored in the device.
- Keep the lid open.
- Wipe off the defrosted water.
- Never use hard or pointed tools to remove ice or to loosen objects which have frozen in place.

Issues	Cause/Suggestions
Refrigerator does not work	<ul style="list-style-type: none"> • Check if the switch is on. • Check if the plug and socket are connected well. • Check if the fuse has been burnt. • Check if the power supply is malfunctioned. • Switch on/off the fridge frequently may cause start delay of the compressor.
Refrigerator compartments are too warm	<ul style="list-style-type: none"> • The door is opened frequently. • A large amount of warm or hot food was stored recently. • The refrigerator has been disconnected for a long time.
Food is frozen	<ul style="list-style-type: none"> • The temperature was set too low.
There is "water flow" noise from inside the refrigerator	<ul style="list-style-type: none"> • It's a normal phenomenon, caused by the flow of refrigerant.
There are waterdrops around the refrigerator casing or door gap	<ul style="list-style-type: none"> • It's a normal phenomenon, the moisture will condense to water when it touches a cold surface of the refrigerator.
The compressor is slightly noisy when starting	<ul style="list-style-type: none"> • It's a normal phenomenon, the noise will be reduced after the compressor works stably.
Code F1 displayed	<ul style="list-style-type: none"> • Possible cause: low voltage to fridge. Adjust the battery protection from High to Medium or from Medium to Low.
Code F2 displayed	<ul style="list-style-type: none"> • Possible cause: condenser fan is overloaded. Disconnect power to fridge for 5 minutes & re-start. If the code shows again, contact manufacturer for service.
Code F3 displayed	<ul style="list-style-type: none"> • Possible cause: the compressor starts too frequently. Disconnect power to fridge for 5 minutes & re-start. If the code shows again, contact manufacturer for service.
Code F4 displayed	<ul style="list-style-type: none"> • Possible cause: compressor not kicking in. Disconnect power to fridge for 5 minutes & re-start. If the code shows again, contact manufacturer for service.
Code F5 displayed	<ul style="list-style-type: none"> • Possible cause: overheating of the compressor & electronics. Disconnect power to fridge for 5 minutes & re-start. If the code shows again, contact manufacturer for service.
Code F6 displayed	<ul style="list-style-type: none"> • Possible cause: no parameter can be detected by the controller. Disconnect power to fridge for 5 minutes & re-start. If the code shows again, contact manufacturer for service.
Code F7 or F8 displayed	<ul style="list-style-type: none"> • Possible cause: temperature sensor is faulty. Contact manufacturer for service.

Environment Protection and Waste Protection and Electrical Equipment Regulations (WEEE)

Recycle unwanted packaging materials. When this product is no longer required, or has reached the end of its useful life, please dispose of it in an environmentally friendly way. Drain any fluids (if applicable) into approved containers, in accordance with local waste regulations. Under the Waste Batteries and Accumulators Regulations 2009, Dellonda would like to inform the user that this product contains one or more batteries. It is our policy to continually improve products and we reserve the right to alter data, specifications and parts without prior notice. No liability is accepted for incorrect use of this product. Guarantee is 12 months from purchase date, proof of which is required for any claim.

Dellonda Limited

Kempson Way, Suffolk Business Park, Bury St Edmunds, Suffolk. IP32 7AR

 01284 757575

 support@dellonda.co.uk

 www.dellonda.co.uk