

baridi

Baridi 24 Bottle Dual Zone Wine Cooler, Touch Screen, LED Light Black Glass Door

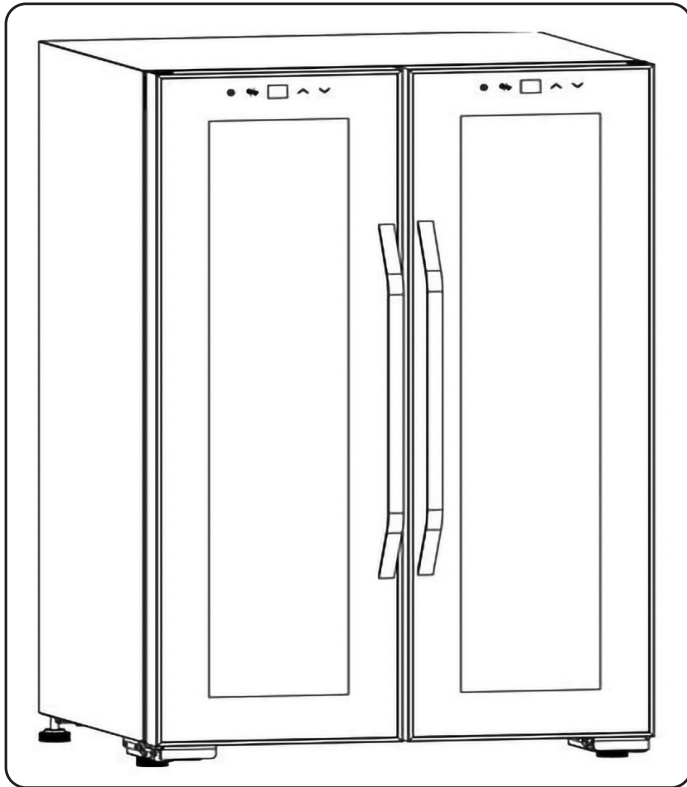

Model No. DH97

Thank you for purchasing a Baridi product from the Dellonda range. Manufactured to a high standard, this product will, if used according to these instructions, and properly maintained, give you years of trouble free performance.

Important Information

Please read these instructions carefully and note any safe operational requirements, warnings & cautions. Use the product correctly and with care for the purpose for which it is intended. Failure to do so may cause damage and/or personal injury and will invalidate the warranty. Keep these instructions safe for future use.



Refer to
instructions



Indoor use
only

• ELECTRICAL SAFETY

- **WARNING!** It is the user's responsibility to check the following:
 - Check all electrical equipment and appliances to ensure that they are safe before using. Inspect power supply leads, plugs and all electrical connections for wear and damage. Dellonda recommend that an RCD (Residual Current Device) is used with all electrical products. You may obtain an RCD by contacting your local domestic stockist. If the product is used in the course of business duties, it must be maintained in a safe condition and routinely PAT (Portable Appliance Test) tested.
- **Electrical safety information:** It is important that the following information is read and understood.
- Ensure that the insulation on all cables and on the appliance is safe before connecting it to the power supply.
- Regularly inspect power supply cables and plugs for wear or damage and check all connections to ensure that they are secure.
- **Important:** Ensure that the voltage rating on the appliance suits the power supply to be used and that the plug is fitted with the correct fuse - see fuse rating in these instructions.
- **DO NOT** pull or carry the appliance by the power cable.
- **DO NOT** pull the plug from the socket by the cable.
- **DO NOT** use worn or damaged cables, plugs or connectors.
- Ensure that any faulty item is repaired or replaced immediately by a qualified electrician.
- This product is fitted with a BS1363/A 13 Amp

- 3 pin plug. If the cable or plug is damaged during use, switch off the electricity supply and remove from use. Ensure that repairs are carried out by a qualified electrician.
- Replace a damaged plug with a BS1363/A 13 amp 3 pin plug. If in doubt contact a qualified electrician.

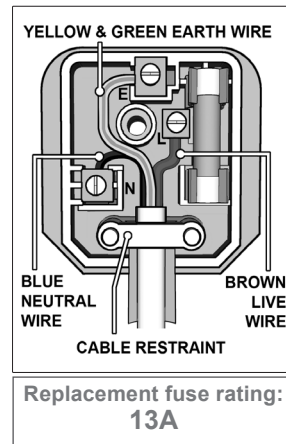

- A) Connect the GREEN/YELLOW earth wire to the earth terminal 'E'.
- B) Connect the BROWN live wire to the live terminal 'L'.
- C) Connect the BLUE neutral wire to the neutral terminal 'N'.

- Ensure that the cable outer sheath extends inside the cable restraint and that the restraint is tight.
- Dellonda recommend that repairs are carried out by a qualified electrician.

- **GENERAL SAFETY**

- **WARNING! IMPORTANT SAFETY INSTRUCTIONS**

- **WARNING!** To reduce the risk of fire, electrical shock, or injury when using your appliance, follow these basic precautions:

- -Before using the appliance, please read this user manual to ensure that you gain the maximum benefit from it.

- **WARNING:**

- 1) This appliance is not intended for use by persons (including children) with reduced physical, sensory or mental capabilities, or lack of experience and knowledge, unless they have been given supervision or instruction concerning use of the appliance by a person responsible for their safety.

- 2) Children should be supervised to ensure that they do not play with the appliance.

- 3) This appliance can be used by children aged from 8 years and above and persons with reduced physical, sensory or mental capabilities or lack of experience and knowledge if they have been given supervision or instruction concerning use of the appliance in a safe way and understand the hazards involved. Children shall not play with the appliance. Cleaning and user maintenance shall not be made by children without supervision.

- 4) If the supply cord is damaged, it must be replaced by the manufacturer, its service agent or similarly qualified persons in order to avoid a hazard.

- 5) To avoid a hazard due to instability of the appliance, it must be fixed in accordance with the instructions.

- 6) When positioning the appliance, ensure the supply cord is not trapped or damaged.

- 7) **DO NOT** locate multiple portable socket-outlets or portable power supplies at the rear of the appliance.

- 8) Keep ventilation openings, in the appliance enclosure or in the built-in structure, clear of obstruction.

- 9) **DO NOT** use mechanical devices or other means to accelerate the defrosting process, other than those recommended by the manufacturer.

- 10) **DO NOT** damage the refrigerant circuit.

- 11) **DO NOT** use electrical appliances inside the drink storage compartments of

the appliance, unless they are of the type recommended by the manufacturer.

- 12) **DO NOT** store explosive substances such as aerosol cans with a flammable propellant in this appliance.

- 13) This appliance is intended to be used in household and similar applications such as

- - staff kitchen areas in shops, offices and other working environments;

- - farm houses and by clients in hotels, motels and other residential type environments;

- - bed and breakfast type environments;

- - catering and similar non-retail applications.

- 14) Children aged from 3 to 8 years are allowed to load and unload refrigerating appliances.

- 15) To avoid contamination of drink, please respect the following instructions:

- - Opening the door for long periods can cause a significant increase of the temperature in the compartments of the appliance.

- - Clean regularly surfaces that can come in contact with drink and accessible drainage systems.

- - Clean water tanks if they have not been used for 48 h; flush the water system connected to a water supply if water has not been drawn for 5 days.

- - If the refrigerating appliance is left empty for long periods, switch off, defrost, clean, dry, and leave the door open to prevent mould developing within the appliance.

- -Note: This appliance contains flammable refrigerant R600a and foaming agent cyclopentane.

- Please avoid contact fire when you transport and use it.

- Professional repair and servicing only.

- Please send to your local appointed disposal station when you discard it.

- -Save these instructions-

- During use, service and disposal pay attention to the symbol 'Risk of fire' (see below) located in the rear of the appliance. There are flammable materials in the refrigerant pipes and the compressor. Keep away from any sources of fire during use and disposal.



• **INTRODUCTION**

- Sleek design with tempered mirror glass doors to reflect UV light and help protect your wine. Dual zone design means you can control the temperature of each zone individually, with the right and left zones ranging from 5-18°C. Soft white LED light. Features ten stylish wooden shelves made of beech with space for up to 12 bottles in each zone. Compressor cooling technology with automatic defrost feature to make this unit as easy as possible to use. Ventilation Space - a minimum space of 10cm is required at the rear, top and both sides of the fridge. This will maximise the efficiency, performance and life of the fridge and ensure that there is sufficient space for the hinge to operate effectively.

• **SPECIFICATION**

- **Model no:** **DH97**
- Actual Product Width:.....508mm
- Capacity:24 bottles
- Energy: efficiency class: G
- Frequency: 50Hz
- Max. bottle height: 320mm
- Noise level: 43dB
- Power Cable Length:.....1.7m
- Dimensions (WxDxH):510x460x800mm
- QC - Electrical Class:.....Class 1
- QC - Plug Type:.....3-Pin BS
- Rated Current: 0.6A
- Temperature range: 5 -18°C
- Voltage: 230V
- Volume: 65L

• **INSTALLATION**

- The unit is designed to be free-standing. Ventilation Space - a minimum space of 10cm is required for the rear, top and sides of the fridge and 5cm under the base. This will maximise the efficiency, performance and life of the fridge and also ensure that there is sufficient space for the hinge to operate effectively.
- **DO NOT** locate the unit in a damp or moist location.
- **DO NOT** locate the unit in direct sunlight.
- Ensure that the floor surface is strong and stable enough to support the unit when it is fully loaded.
- Level the unit when in location by using the adjustable levelling feet in each corner.
- Once in position allow the unit to rest for an hour before turning it on.
- Allow the unit 2 - 3 hours to reach set temperature after switching on before placing any items in the compartment.





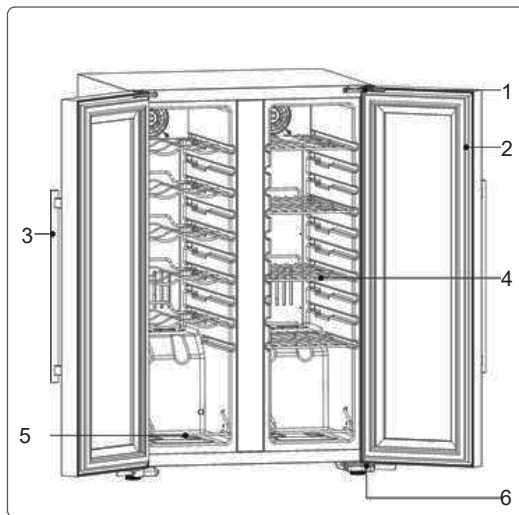

• **PARTS AND FEATURES**

- 1: Upper Hinge
- 2: Door Gasket
- 3: Door Handle
- 4: Shelves
- 5: Display Shelves
- 6: Bottom Hinge



• OPERATION



- To unlock settings for each section give one 2 second press on the symbol. 
- To turn the light on press the  symbol and again for off.
- The light in the unit will turn off automatically after 10 minutes if the unit is not used.
- To switch between Celsius and Fahrenheit press on the  symbol for 2 seconds.
- Use the  symbol to increase the temperature setting in each compartment.
- Use the  symbol to lower the temperature setting in each compartment.
- When you have set the desired temperatures leave the keypad for 20 seconds and it will lock and retain those settings.
- The light and temperature setting button will work as normal.
- To unlock the keypad press the  symbol again.
- Temperature in the either section can range from lowest 5°C/41°F to maximum 18°C/64°F.
- Left and right sections operate independently of each other.
- Automatic defrost feature operates after 12 hours use and the unit will stop working for 30 minutes.
- Settings are retained after unit is switched off.

• MAINTENANCE

- Remove the power plug from the supply when performing cleaning or maintenance.
- **DO NOT** use abrasive or chemical cleaning materials on any surface of the unit.
- Wipe interior and exterior surfaces with a damp cloth and dry thoroughly with a clean dry cloth.
- For more soiled surfaces use a neutral detergent, wipe down with a clean damp cloth and dry thoroughly with a clean dry cloth.

Troubleshooting

- Error codes
- EE: "EE" is displayed when the temperature probe is short-circuited or disconnected and cooling is stopped.
- LL: When the temperature measured by the temperature probe is lower than 0 degrees Celsius, "LL" is displayed, LL flashes, and the unit is stopped.
- HH: When the temperature measured by the temperature probe is higher than 37 degrees Celsius, "HH" is displayed, HH flashes, and the unit is stopped.

Symptom	Solution
Unit does not operate.	Not plugged in. Fuse/circuit breaker failure.
Turns on and off frequently. Poor cooling.	Room temperature higher than normal. Door opened too often. Door not properly closed. Temperature control incorrectly set. Door gasket not sealing. Not enough space around unit.
Vibrations	Check to assure unit is level.
Noisy unit	Contraction/expansion of panels. Unit not level. Check fan operation. Check heat pump.
Door will not close properly	Unit not level. Gasket distorted. Internals out of position.



Environment Protection, Waste Electrical and Waste Electronic Equipment Regulations (WEEE)



Recycle unwanted packaging materials. When this product is no longer required, or has reached the end of its useful life, please dispose of in an environmentally friendly way. Drain any fluids (if applicable) into approved containers, in accordance with local waste regulations. It is our policy to continually improve products and we reserve the right to alter data, specifications and parts without prior notice. No liability is accepted for incorrect use of this product. Guarantee is 12 months from purchase date, proof of which is required for any claim.

Dellonda Limited, Sole UK Distributor of Baridi

Kempson Way, Suffolk Business Park, Bury St Edmunds, Suffolk. IP32 7AR



01284 757575



support@dellonda.co.uk



www.dellonda.co.uk