

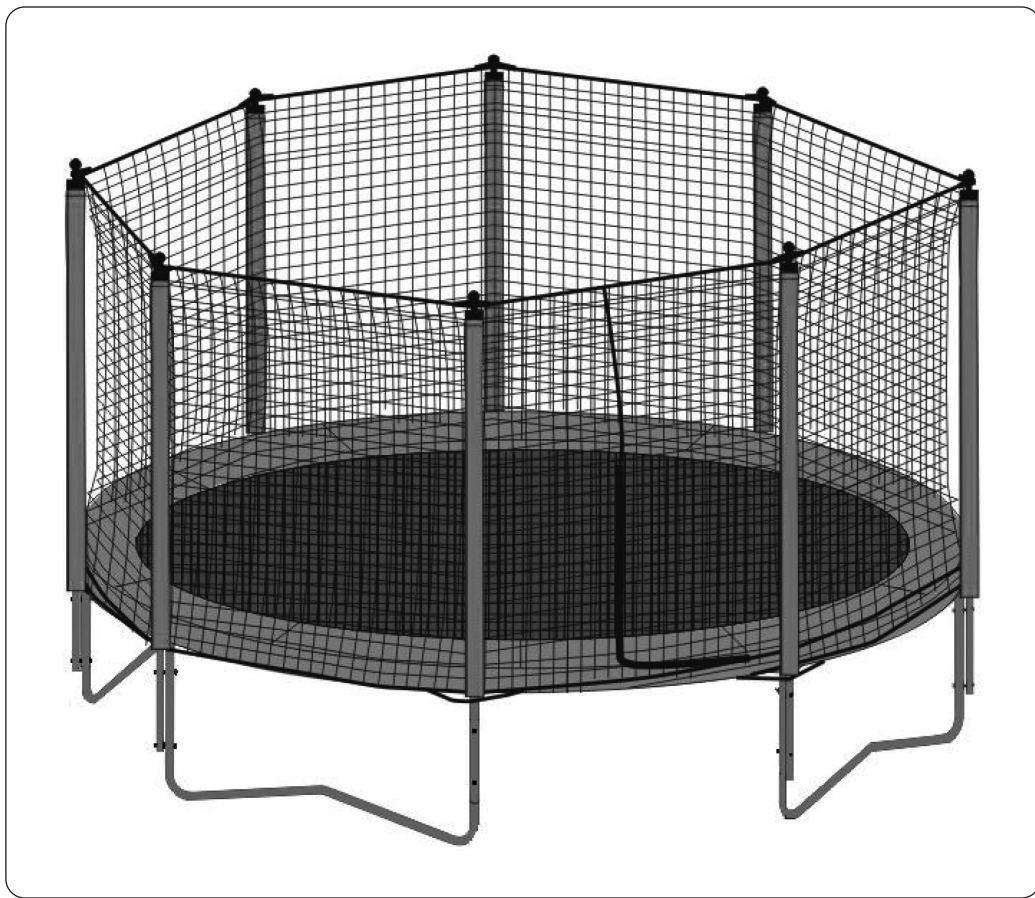

Dellonda 10ft Heavy Duty Outdoor Trampoline for Kids with Safety Enclosure Net



Model No. DL68

Thank you for purchasing a Dellonda product. Manufactured to a high standard, this product will, if used according to these instructions, and properly maintained, give you years of trouble free performance.

Important Information

Please read these instructions carefully. Note the safe operational requirements, warnings & cautions. Use the product correctly and with care for the purpose for which it is intended. Failure to do so may cause damage and/or personal injury and will invalidate the warranty. Keep these instructions safe for future use.



Refer to
instruction
manual



Wear protective
gloves



Wear eye
protection

About the Product

Heavy-Duty Trampoline ideal for keeping children active whilst having fun at home. Fitted with PE safety enclosure net with zip entrance door to limit risk of injury. Tested and approved to EN71. PVC and PE covered EPE foam surround to protect children from accidentally landing on the springs. High quality galvanised steel springs tested to last for a minimum of 1 million bounces!

• SPECIFICATION

- **Model no:** **DL68**
- **Dimensions (ØxH):** 3050 x 680mm
- **Maximum user weight:** 100kg (220lbs)
- **Number of springs:** 54pcs
- **Shape:** Round
- **Bounce mat size:** Ø2640mm
- **Number of legs** 3

Safety Instructions

- Always read these instructions fully before assembling and using your trampoline.
- **WARNING! This trampoline has a maximum user weight of 100kg (220lbs).**
- **NOT** suitable for children under 36months of age.
- **WARNING! Only for domestic use.**
- **WARNING! Outdoor trampolines should be equipped with a ground fixing kit or method of securing it so that it will not be affected by strong winds or adverse weather conditions.**
- Checks and maintenance are vital although it is recommended you replace the bounce mat and safety net every 2 years.
- This product is **not** designed to be buried in the ground. This trampoline should be assembled by a competent adult in accordance with the assembly instructions and checked thoroughly before being used for the first time.
- The trampoline should be routinely checked by a responsible person to ensure it is in serviceable condition at all times.
- **WARNING! If this product becomes worn or damaged in any way you must immediately stop using it until any areas of concern are repaired or replaced to a serviceable standard by a competent person.**
- Only one person should be using this trampoline at a time (Risk of collision, single user only).
- **No shoes** to be worn whilst using this trampoline.
- **NO NOT** use this trampoline when the bounce mat is wet.
- Ensure your pockets and hands are empty before entering and bouncing on the trampoline.
- **WARNING! Always jump in the centre of the bounce mat and NOT on the edges of the mat.**
- **DO NOT** eat or drink whilst jumping on the trampoline.
- **WARNING! Always stop jumping before exiting the trampoline. Always exit the trampoline using the net door opening only.**
- When entering the trampoline ensure the net door opening is zipped closed behind you before starting to jump.
- Limit the amount of time you continuously use the trampoline for, make regular stops.
- **DO NOT** use this trampoline whilst under the influence of alcohol or drugs or under any instruction from a Doctor.
- Stop exercising immediately should you feel unwell or if you feel pain in your joints and muscles. Dizziness is a sign of fatigue and you should stop bouncing and lay down on the ground should you feel dizzy.
- Please be warned that trampoline is spring based and will allow the user to jump to a greater height than that on the ground, so please bear this in mind and ensure that you are comfortable bouncing at low heights first.
- Anybody who chooses to use the trampoline must be aware of their own limitations with regards to performing skills on this trampoline.
- The safety enclosure is there to prevent the user falling off the trampoline, and is not to be jumped into unnecessarily.
- **DO NOT** position the trampoline on concrete, stone or any paved hard surface.
- The trampoline should be located over grass or **BSI** approved matting, 2m away from any garden structure or obstruction such as a fence, garage, overhanging branches, laundry lines and electric lines.
- **DO NOT** position the trampoline within 2m of anything else such as paddling pools, swings, slides and climbing frames.
- Any modifications or changes to this unit (e.g. the adding of an accessory) shall be carried out to the instructions of the manufacturer.
- **WARNING! DO NOT** use in strong wind conditions and secure the trampoline.
- **WARNING! No somersaults.**
- **WARNING! This trampoline is for outdoor use only.**

Daily checks required before using

- Inspect legs for proper attachment ensure they have no cracks, damage or rust.
- Inspect the safety netting for any tears, damage and sagging, also inspect for loose or damaged springs.
- Inspect the mat for tears or worn stitching, damage and sagging.
- Check that the legs are properly attached and stable on the ground; no loose springs, mat and enclosure net are in correct place and in good condition with no tears or damage.
- **WARNING! If the trampoline fails any of the above Daily/Before use inspections, DO NOT USE! You are at risk of serious injury or death.**

How to move the trampoline

- To move the trampoline, it is recommended for the trampoline to be disassembled and then reassembled in the new location. However, if you need to move the trampoline a short distance for any reason, you must ensure all parts remain fully assembled. To move the trampoline requires two or more people to lift the trampoline, lift vertically until clear off the ground. **DO NOT** drag the trampoline along the ground. The trampoline must be kept steady and horizontal to the ground during the move. After the trampoline has been moved to its new location ensure the entire product is fully checked for loose fixings and any damage, Failure to follow these instructions may result in the frame support coming loose which may cause serious injury or death. (Retain these instructions for future use)

Information on the use of the trampoline



INITIALLY, you should get accustomed to your trampoline and understand how much spring is in each bounce. The focus at this point should be body position and technique until each skill can be completed with ease and control.

BEFORE YOU TRY TO JUMP TOO HIGH the technique for stopping should be learnt as this will help prevent injury should you feel you are jumping out of control.

As the user lands there knees should be bent so that they stop and absorb the spring in the mat. The position is shown in the image to the left. Arms are held out for increased level of balance.

This skill is used when the trampoline user wishes to stop bouncing for what ever reason.



SOMERSAULTS (FLIPS): DO NOT PERFORM somersaults of any type (backwards or forwards) on this trampoline. If you make a mistake when trying to perform a somersault, you could land on your head or neck. This will increase your chances of your neck or back being broken, which could result in death or paralysis.



FOREIGN OBJECTS : DO NOT use the trampoline if there are pets, other people, or any objects underneath the trampoline. This will increase the chances of an injury occurring. **DO NOT** hold any foreign objects in your hand and **DO NOT** place any objects on the trampoline while in use.

DO NOT place the trampoline under over-hanging objects like tree branches, wires, etc. as these will increase your chances of being injured.



POOR MAINTENANCE OF TRAMPOLINE: A trampoline in poor condition will increase your risk of being injured. Please inspect the trampoline before each use for bent steel tubes, torn mat, loose or broken springs and overall stability of the trampoline.



WEATHER CONDITIONS: Please be aware of the weather conditions when using the trampoline. If the mat of the trampoline is wet, the user could slip and injure himself/herself. If it is too windy, the user could lose control.



RESTRICTING ACCESS: When the trampoline is not in use, always store the access ladder in a secure place so that unsupervised children can not play on the trampoline.

Tips to reduce the risk of accidents

- **INITIALLY**, you should get accustomed to your trampoline and understand how much spring is in each bounce. The focus at this point should be body position and technique until each skill can be completed with ease and control.

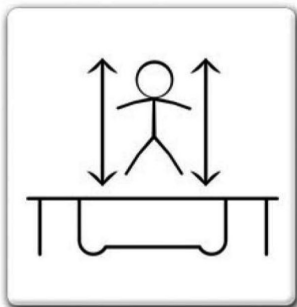

- In order to reduce the risk of accident the “TRAMPOLINE USER” should:
- Always remain in control of their jumps and body position at all times.
- Not attempt to perform skills that are beyond their own level of competence.
- Read and understand all of the instructions.
- Always control their jump by taking off and landing in the middle of the trampoline.
- Always jump vertically and refrain from bouncing towards the springs in any direction.
- Always consult a professionally certified trampoline instructor before attempting anything beyond basic techniques.

In order to reduce the risk of accident the “Person supervising” should:

- Fully understand and enforce all the safety rules and guidelines.
- Advise the trampoline user and provide knowledge in what they are doing right and wrong to ensure the safety of trampoline user.
- Be aware and advise the trampoline user of all the safety warnings.

IMPORTANT: If the trampoline can not be supervised there should be a method for securing it and preventing anyone from using the product until supervision is available.

Advisory precautions whilst supervising the use of the trampoline

- **IMPORTANT:** Familiarise yourself with the basic jumps and safety rules. To prevent and reduce the risk of injuries, ensure that all safety rules are enforced and the new users learn the basic bounces before trying more advanced techniques.
- ALL USERS need to be supervised, regardless of skill level or age.
- Never use the trampoline when it is wet, damaged, dirty or worn out. The trampoline should be inspected before use.
- Keep all objects that could interfere during use away from the trampoline at all times. Be aware of what is overhead, underneath and around the trampoline.
- To prevent unsupervised and unauthorized use, the trampoline should be secured at all times.

Trampolining techniques

- **Basic skills 1: The Bounce**

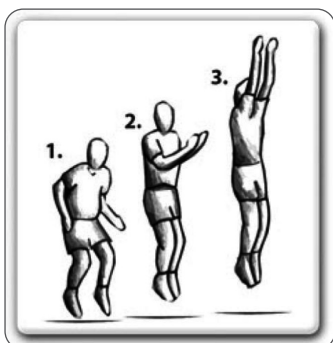

- Start from a standing position, with feet shoulder width apart head up and eyes on the trampoline bed.
- Swing arms forward and up above head in a circular motion.
- Bring legs and feet together in mid-air position and point toes.
- Land back on the mat with feet shoulder width apart (same as start position).
- Only move onto the next skill once comfortable and proficient.

• **Basic skill 2: The Knee Drop**



- Start with a low basic bounce (as detailed in Basic skill 1).
- Land on knees shoulder width apart, keeping back straight and a strong body position using arms out to the side or in front to maintain balance.
- Bounce back to basic bounce position by using bounce momentum and swinging arms above head.
- Remember to always stay in control of the height of your bounce.

• **Basic skill 3: The Seat Drop**



- Start with a low basic bounce (as detailed in Basic skill 1).
- Land with legs out straight in front of you, with hands either side of your hips and back straight in a strong body position.
- Use the bounce momentum aided with a push from hands to return to a standing position.
- Remember to always stay in control of the height of your bounce.

Assembly

- To assemble this trampoline all you need is our special spring loading tool provided with this product.
- During periods of non-use. This trampoline can be easily disassembled and stored.
- Please read the assembly instructions before beginning to assemble the product.
- Please refer to the table for part descriptions and numbers. The assembly instruction use these descriptions and numbers as reference .
- Make sure you have all parts listed. If you are missing any parts, please contact our customer service team.
- Please use gloves to protect your hands from pinch points during assembly.
- When you are ready to start, make sure that you have plenty of space and a clean dry area for assembly.

Parts list

Ref Number	Description	Unit	DL66 6"	DL67 8"	DL68 10"	DL69 12"
1	Trampoline Mat, stitched with V-Rings	Pcs	1	1	1	1
2	Frame Pad	Pcs	1	1	1	1
3	Top Rail	Pcs	6	6	6	8
4	Leg Base	Pcs	3	3	3	4
5	Vertical Leg Extension	Pcs	0	6	6	8
6	Springs	Pcs	36	48	54	72
7	User Manual	Pcs	1	1	1	1
8	Spring Tool	Pcs	1	1	1	1
9	Bolt pack	Pcs	0	6	6	8
10	T Connector	Pcs	6	6	6	8
11	Spanner	Pcs	1	1	1	1

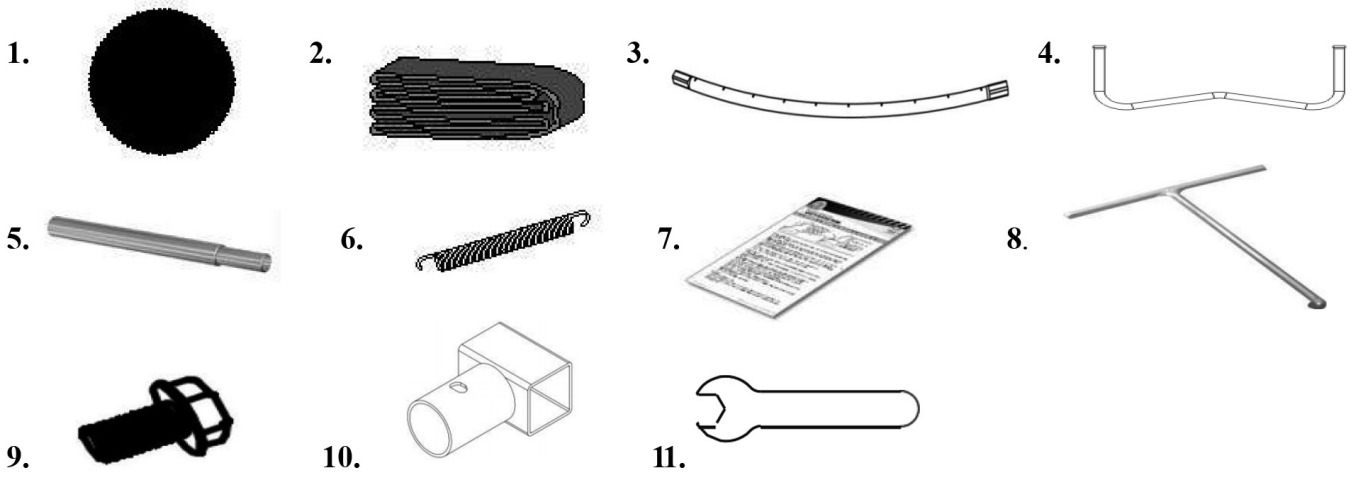

Frame layout and assembly

- Use the table on the previous page to identify which model, size and layout you have purchased then refer to the following images, follow the layout that matches your product.

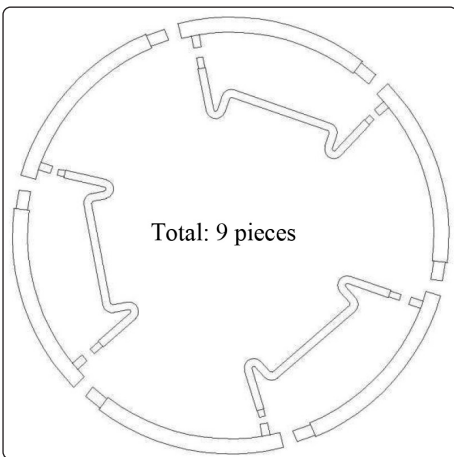

• Step 1 - Layout your frame components

• DL66 6ft Trampoline with 3 legs

- Ensure you have plenty of space to begin assembly, layout the frame components as shown prior to starting assembly.

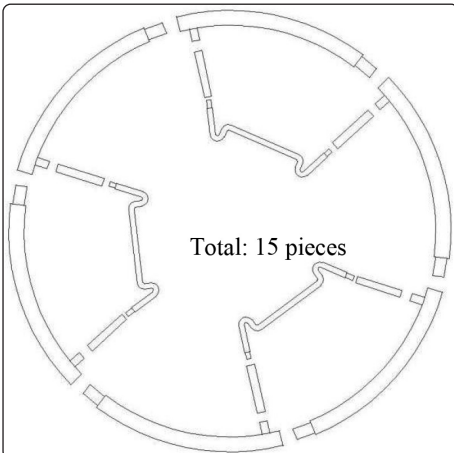

• DL67 8ft and DL68 10ft Trampolines with 3 legs

- Ensure you have plenty of space to begin assembly, layout the frame components as shown prior to starting assembly.

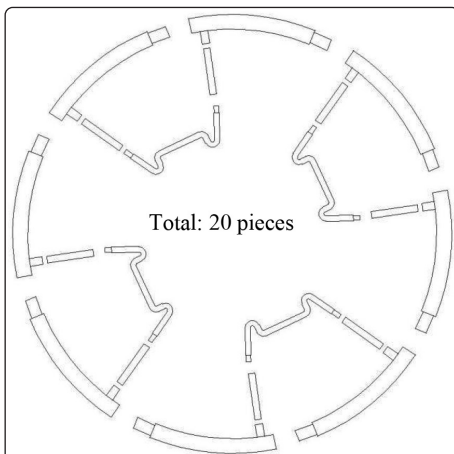

• DL69 12ft Trampoline with 4 legs

- Ensure you have plenty of space to begin assembly, layout the frame components as shown prior to starting assembly.

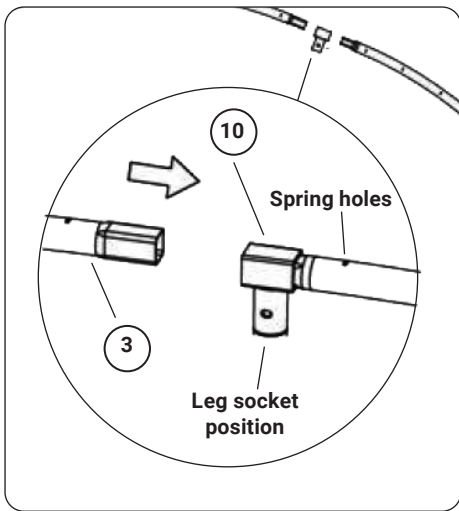

• **Step 2 - Top rail assembly**

- Begin socketing the curved rail sections (3) into the T Connectors (10) ensure that the T connectors are assembled the same way round with the leg socket pointing down (opposite side to the spring holes).
- 2 people will be required to assemble the frame.

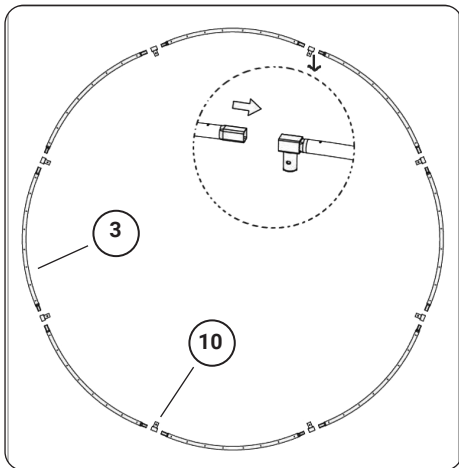

- Depending on the size of your trampoline your frame will either have six top rail sections (3) and T Connectors (10) or eight.
- The assembly process is the same for both.

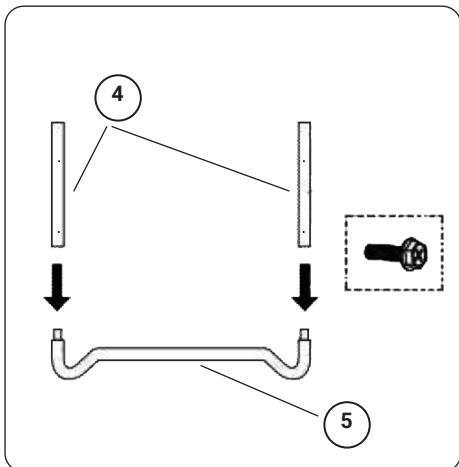

• **Step 3 - Leg assembly**

- Socket the vertical leg extenders (4) onto the base leg (5) as shown in the illustration, secure in place the screws provided.

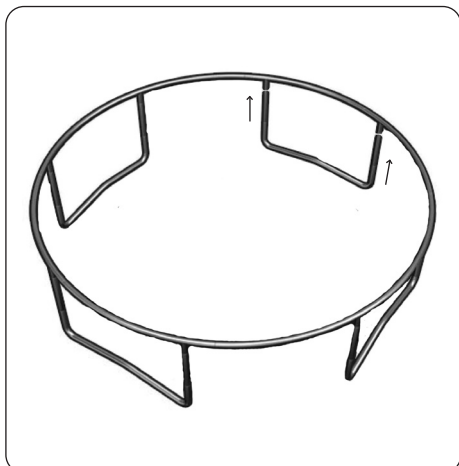

- Lift the frame and insert to assembled legs into the T sockets from the underside of the ring frame. (The legs will be bolted on when the safety net legs are added).

Attaching the bounce mat



• Step 4 - Attaching the trampoline mat

- With your frame fully assembled and standing on its feet, spread the bounce mat out inside the frame and facing upwards (see markings and ensure the seam is facing the ground).
- As you start to attach the springs, be very careful, you will need at least one person to help you, as the you start to put the mat under tension and add strings the risk of accident and injury is increased.

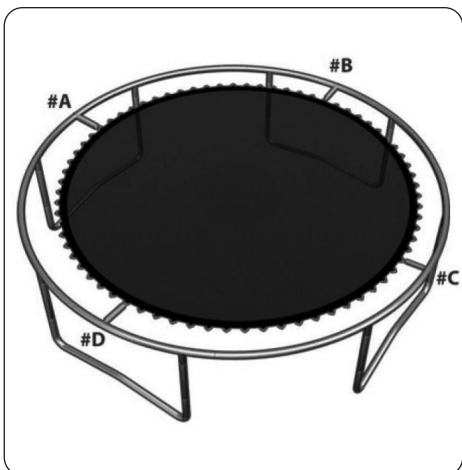

• Step 5 - Adding the mat springs



Wear eye protection

- **Warning!** Be careful adding the springs these can cause injury and trap hazards.
- Lift the mat and start adding the springs beginning with 4 evenly spread as shown in the illustration, this will keep your mat taught and will make it easier to attach the rest.

Description	Unit	6"	8"	10"	12"
Springs	Pcs	36	48	54	72
Spring Tool	Pcs	1	1	1	1

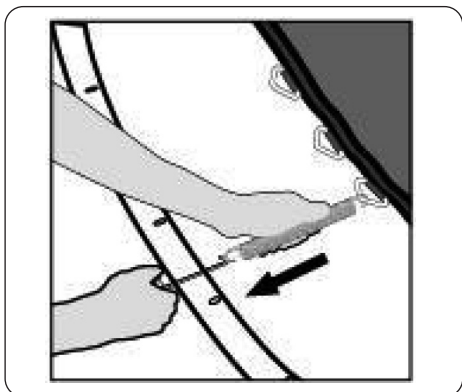

- Working from opposite sides begin adding the springs, hook one end of the spring into the next eyelet on the mat, attach the spring tool to the other end stretch and support the spring as shown.



- Hook the open end of the spring into the next corresponding hole in the frame and release the spring tool **carefully**.

Attaching the frame padding

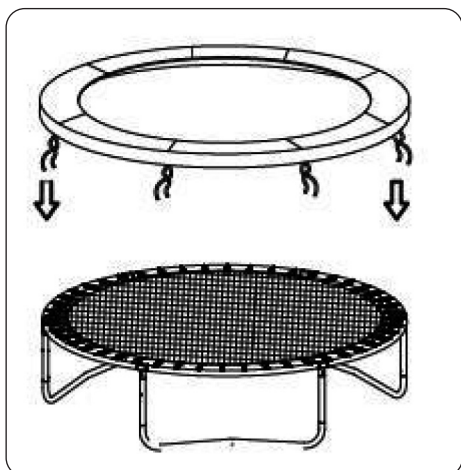

• Step 6 - Frame pad assembly

- Lay the frame padding out on top of the trampoline until all of the frame and springs are covered, ensure the padding is the right way up and the tie straps are facing down.

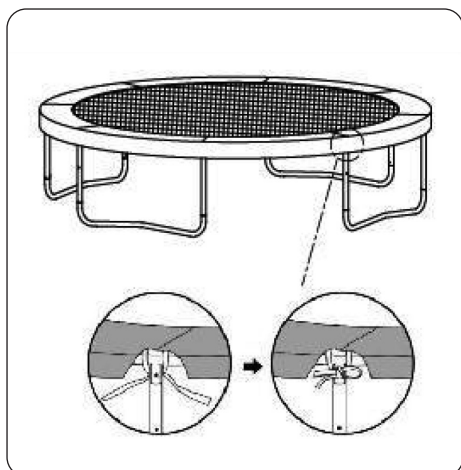









- Rotate the padding so the tie straps line up with the leg positions. Tie the padding around the frame and leg, this will help to stop the padding from moving.

Safety net/Safety net assembly

Parts list

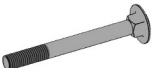
Ref Number	Description	Unit	DL66 6"	DL67 8"	DL68 10"	DL69 12"
1	Upper Pole A	Pcs	6	6	6	8
2	Upper Pole B	Pcs	6	6	6	8
3	Bar Spacers	Pcs	12	12	12	16
4	Curved Washers	Pcs	12	12	12	16
5	Screws	Pcs	12	12	12	16
6	Nuts	Pcs	12	12	12	16
7	Pole Cover	Pcs	6	6	6	8
8	Washer	Pcs	12	12	12	16
9	Safety Net	Pcs	1	1	1	1

Contents

- 1. Upper pole A 
- 2. Upper pole B 
- 3. Bar Spacers 
- 4. Curved Washers 
- 5. Screws 
- 6. Nuts 
- 7. Pole Cover 
- 8. Washers 
- 9. Safety Net 

Safety net assembly

Step 1: Connect the upper pole A to the upper pole B, depress the spring connector and carefully slide the two sections together until the spring connector pops out of the locating hole (Fig. 1), Repeat this process until all of the net poles are connected.

Step 1: Slide the sections of foam padding over the poles in turn (Fig. 2). and screw into place the top cap on each pole using the self tapping screws

Step3: Over the assembled pole slide the waterproof cover sleeve ensuring it slides over the top of the cap but not over the shoulder and down the pole (Fig. 3)

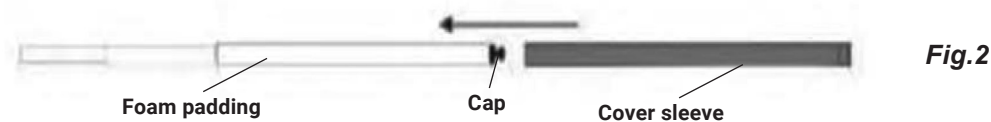
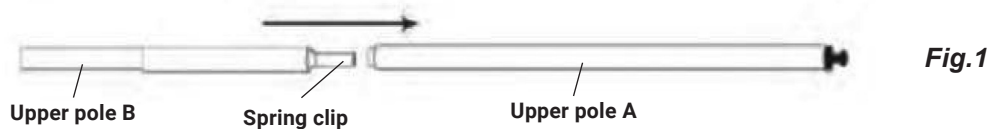

Step 4: Line up the net poles with the holes in the leg extensions on the main frame as shown (Fig.4), pass the coach bolts through the leg, bar spacer, frame leg add the curved washer (Fig.5), tighten off with the capped nuts on the inside of the leg assembly (Fig.6).

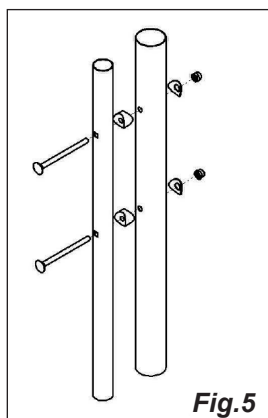
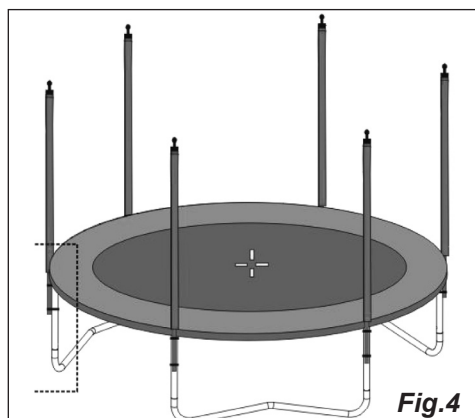

Step 5: Spread the net out on the bounce mat W where you want the entrance to be and begin to hang the top of the net over the pole caps with the integral hanging points (Fig.7).

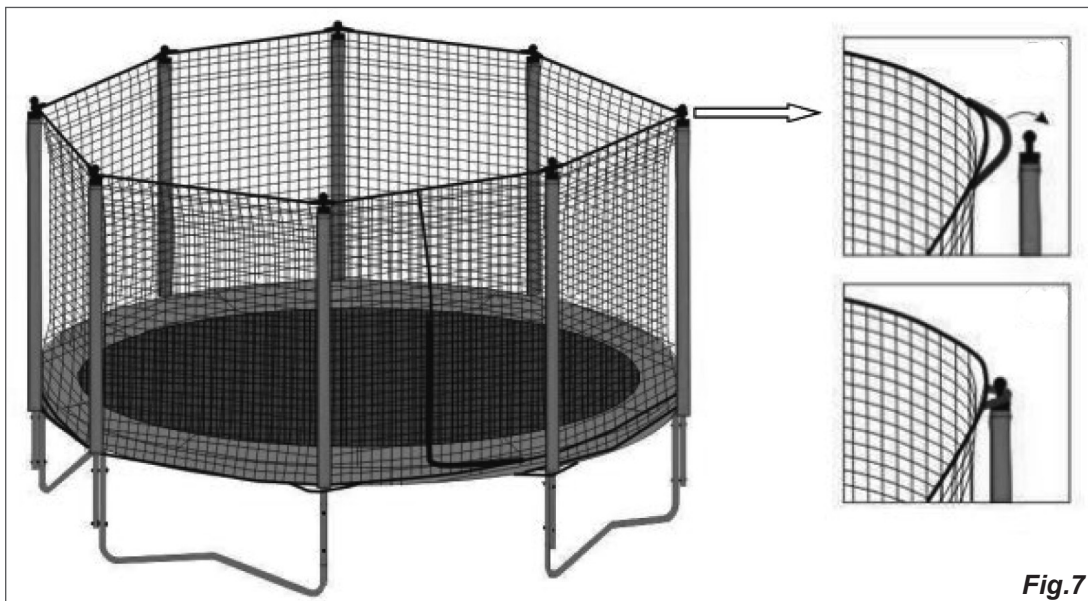

Fig.7

Step 6: Once the net is loosely hung beginning at the doorway stretch and hook down the net as shown (Fig.8) secure the net hooks around the base frame and attach to the V-rings where the matt springs hook onto the bounce mat.

- **Warning!** Be careful adding the springs these can cause injury and trap hazards.

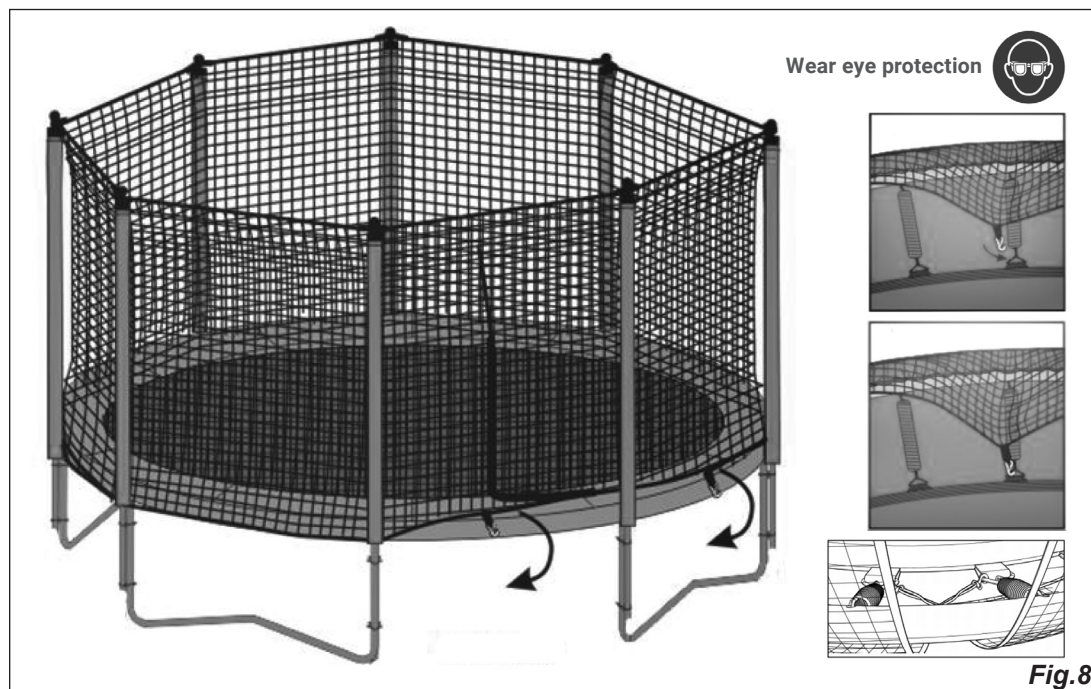

Fig.8

WARNING! You should go back and re-stretch all the net components periodically and re-tie it to ensure the net is taught and stands stiff at all times. If it is left to sag or loosen it **WILL** compromise the safety of your trampoline and it's users.

This should complete the assembly of your trampoline, please ensure you have read and understood all of the safety information and instructions prior to use.

Maintenance

- Regularly check all nuts, bolts and fixings and tighten when required immediately.
- Check all coverings, net and bounce mat regularly to ensure they are not damaged, torn, frayed or excessively worn, repairs or replacements must be made immediately.
- Outdoor trampolines should be equipped with a device that in strong wind conditions prevent to unintentional movement of the trampoline due the wind. (Ground fixing kits, or heavily loaded sand or water bags can be used).
- Excessive exposure to snow, rain and low temperatures can damage the materials used in the trampoline, it is strongly recommended to remove snow and excess water and ideally to remove all padding, bounce mats and netting and store them in a dry location when not use for an extended period.

Note: It is our policy to continually improve products and as such we reserve the right to alter data, specifications and component parts without prior notice.

Important: No Liability is accepted for incorrect use of this product.

Warranty: Guarantee is 12 months from purchase date, proof of which is required for any claim.

Environment Protection and Waste Protection and Electrical Equipment Regulations (WEEE)

Recycle unwanted packaging materials. When this product is no longer required, or has reached the end of it's useful life, please dispose of it in an environmentally friendly way. Drain any fluids (if applicable) into approved containers, in accordance with local waste regulations. It is our policy to continually improve products and we reserve the right to alter data, specifications and parts without prior notice. No liability is accepted for incorrect use of this product.

Dellonda Limited

Kempson Way, Suffolk Business Park, Bury St Edmunds, Suffolk. IP32 7AR



01284 757575



support@dellonda.co.uk



www.dellonda.co.uk