



**Dellonda Deluxe Kamado BBQ Grill/Oven/
Smoker, Ceramic 16" (40cm)**



Model No. DG158

Thank you for purchasing a Dellonda product. Manufactured to a high standard, this product will, if used according to these instructions, and properly maintained, give you years of trouble free performance.

Important Information

Please read these instructions carefully. Note the safe operational requirements, warnings & cautions. Use the product correctly and with care for the purpose for which it is intended. Failure to do so may cause damage and/or personal injury and will invalidate the warranty. Keep these instructions safe for future use.



Refer to
instruction
manual



Wear
Gloves



Warning:
Hot
Surface

Specification

Model No	DG158
Assembled Product Dimensions	40 x 58cm
Temperature Range	105°C - 485°C
Cooking Grid Diameter	33cm (13")

About the Product









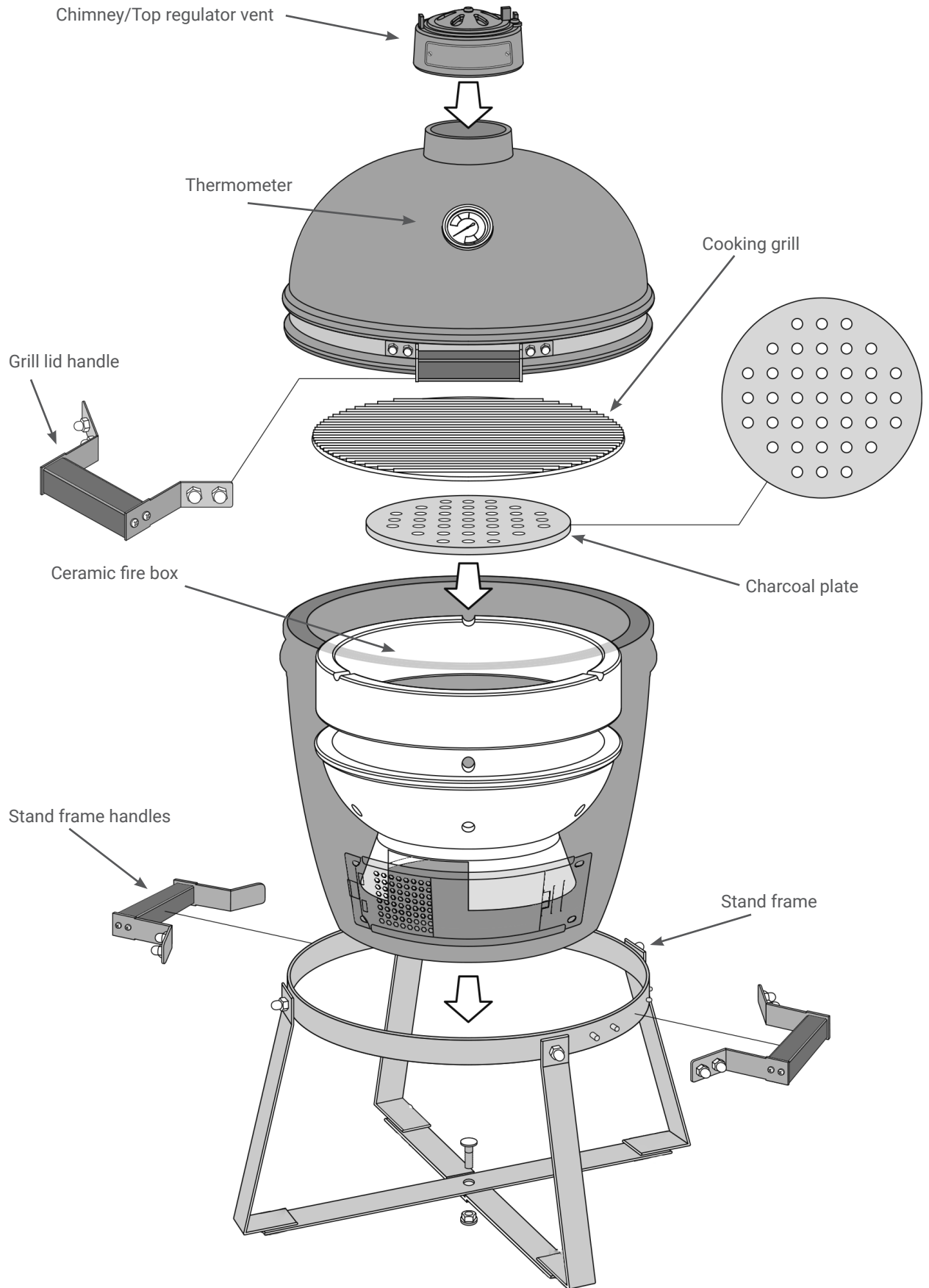

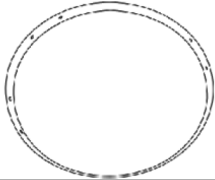
The Dellonda Kamado style barbecue is the perfect addition to your outdoor living area. Amaze your guests with an unforgettable al-fresco dining experience. Caters for all parties with the option of cold smoking, searing, grilling, baking and slow cooking, our Kamado barbecue has something for everyone! Ceramic outer shell and egg design provides excellent heat retention and cooking temperatures up to 900°F (485°C). Suitable for use with charcoal and untreated wood chips. Ventilation at the top and bottom of the barbecue gives you complete control of your cooking and airflow.

Safety Instructions

- **GENERAL SAFETY**
- **WARNING! The warnings, cautions and instructions in this manual cannot cover all possible conditions and situations that may occur. It must be understood by the operator that common sense and caution are factors which cannot be built into this product, but must be applied by the operator.**
- **WARNING! Hazardous fire or explosion may result if instructions are ignored. Read instructions before use.**
- **WARNING! Accessible parts may be very hot. Keep young children and pets away. Take special care when children and elderly are present.**
- **WARNING! Any modification to this appliance may be dangerous and is absolutely not permitted.**
- Read the instructions carefully before assembly and retain this manual for future reference.
- **Use outdoors only**, stand on a level surface, remember hot fat may drip out.
- Handle the hot grill with the help of oven gloves.
- Use oven gloves and sturdy long handled barbecue tools when cooking on the grill.
- Be prepared if an accident or fire should occur. Know where your first aid kit and fire extinguishers are and how to use them correctly.
- Ensure the appliance has completely cooled before storing.
- **DO NOT** use indoors! This grill is designed for outdoor use in a well-ventilated place, and is not intended as a heating device and should never be used as such. When used indoors, toxic fumes accumulate which result in serious bodily injury or death.
- **DO NOT** use petrol, alcohol or other highly volatile substances to ignite the fuel.
- **DO NOT** add charcoal-igniting liquid or power-soaked charcoal to hot or warm charcoal.
- Keep the area around the grill free of flammable fumes and liquids such as petrol, alcohol, flammable materials, etc.
- Use the grill only after all parts have been assembled. This grill must be mounted correctly according to the assembly instructions. Incorrect assembly can be dangerous.
- The use of alcohol, or medicines available with or without a prescription, may affect the user's ability to position the grill properly or use it safely.
- Be careful when using the grill. During grilling or cleaning, the grill is hot, and should never be left unattended.
- **WARNING! This barbecue gets very hot, don't move it during use.**
- **WARNING! Do not use spirit, petrol or other flammable liquids to (re)ignite! Only use detonators that meet the EN 1860-3!**
- **DO NOT** use the grill within 2 metres of flammable materials. Inflammable materials include, but are not limited to wood or to treated wooden decks, patios and porches.
- Always keep the grill on a safe and flat surface, at a distance from flammable materials.
- **DO NOT** wear loose-sleeved clothing while lighting or using the grill.
- Never touch the grill or charcoal grid, ash or charcoal to make sure they are hot.
- After grilling, close all the vents and lid and allow the grill to extinguish naturally and cool.
- Use heat-resistant barbecue mittens or gloves while grilling, adjusting the vents (dampers), adding charcoal and using the thermometer or lid.
- Use the right tools with long, heat-resistant handles.
- Always place the charcoal on top of the (bottom) charcoal grid. Do not place charcoal directly at the bottom of the boiler.
- **DO NOT** lean on the table, or overload the end of it.
- Never throw away hot charcoal where it can be walked over or where it poses a fire hazard. Never discard the ash or charcoal until they are completely extinguished and cool.
- **DO NOT** put the grill away or store it until the ash and charcoal are completely extinguished and cold.
- **DO NOT** remove the ash until all the charcoal is completely burnt out and completely extinguished and the grill has cooled down.
- Keep electrical wires and cords away from the hot surfaces of the grill and away from places with lots of foot traffic.
- **WARNING! Do not use the barbecue in a confined space, for example in a house, tent, caravan, vehicle or small space. Risk of fatal accidents due to carbon monoxide poisoning.**
- **DO NOT** leave unattended, from being lit to fully cooled or position on a surface that may be damaged by hot fat or heat.
- **DO NOT** store petrol or other flammable vapours or liquids in the vicinity of use.

Contents



DESCRIPTION		IMAGE
Grill frame mounting ring	1	
Grill frame foot stand	2	
Cooking grill	1	
Fire bowl charcoal plate	1	
Ceramic Fire bowl	1	
Chimney/Top regulator vent	1	
Kamado grill main body	1	
Grill main body lid handle	1	
Grill frame carry handles	2	
M6 x 16mm bolts	14	
M6 dome nuts	8	

Assembly

- Please read the assembly instructions carefully and follow the safety precautions. Allow sufficient time for assembly. Before starting assembly, clear an area measuring approximately two to three square metres. Remove the item from the packaging and lay out all of the parts and any necessary tools so that they are within easy reach.
- Only tighten all of the screw connections firmly when you have finished assembly or are instructed to within the manual. Otherwise this can result in misalignment and tension in components.
- **Step 1**
- Stand the two grill frame foot stands up and across each other, pass a bolt down through the lined up holes in the centre and loosely spin on a dome nut. See Fig. 1.

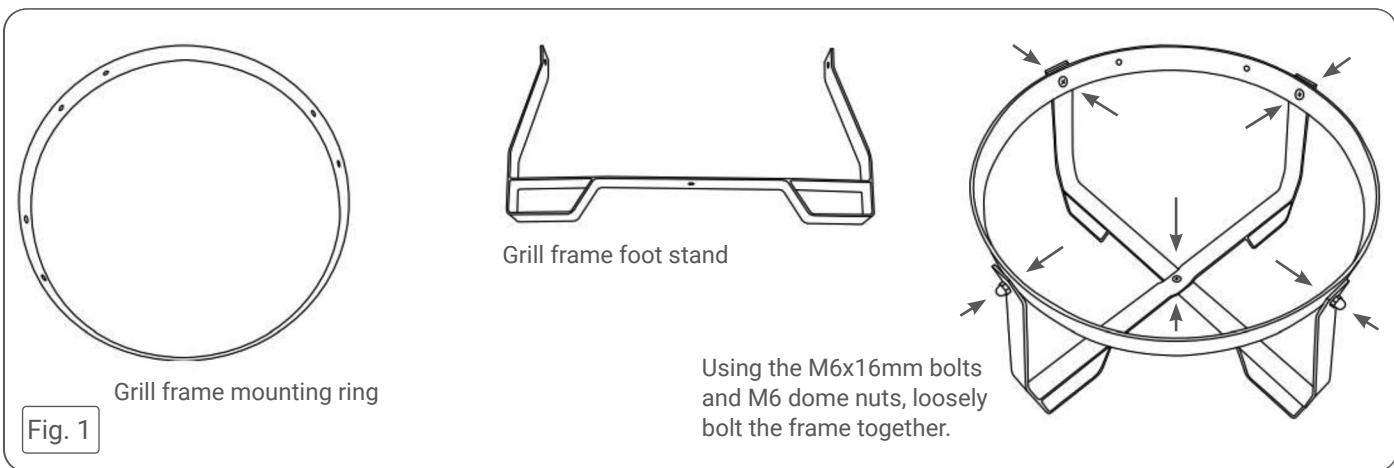

- **Step 2.**
- Carefully open the grill, place the ceramic firebox into the base of the main grill, in turn put the charcoal plate and cooking grilling into and on the rim of the fire bowl. See Fig. 2.

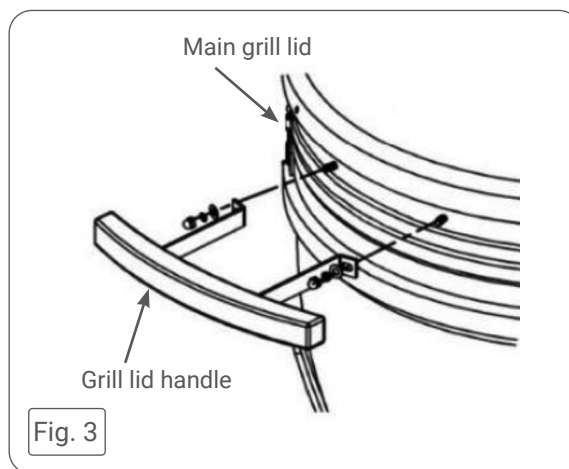
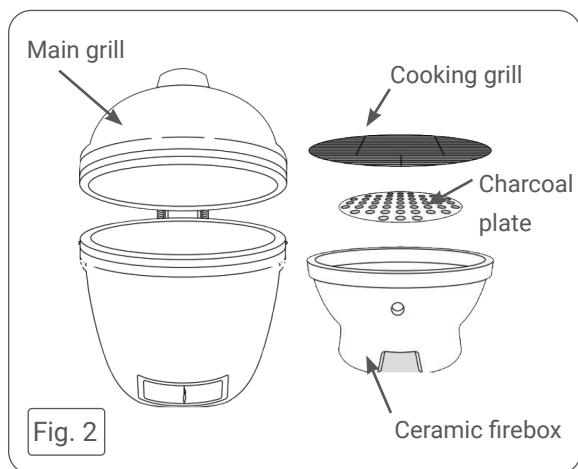

- **Step 3.**
- Using the nuts and bolts provided offer up and bolt on the main grill lid handle, tighten down with the M6 dome nuts. See Fig. 3.
- **Step 4.**
- Carefully lift (two people may be required) and place the assembled Kamado grill into the completed frame stand, lift and turn the unit to orientate the grill in the base frame with the frame carry handles and the grill lid handle at 90° to each other this will allow easy access to all of the handles. See Fig. 4.

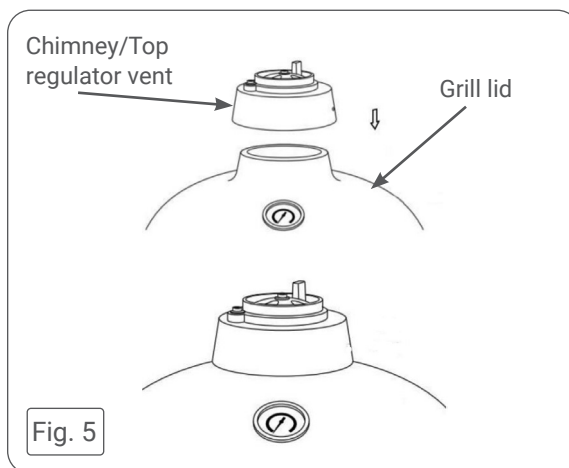
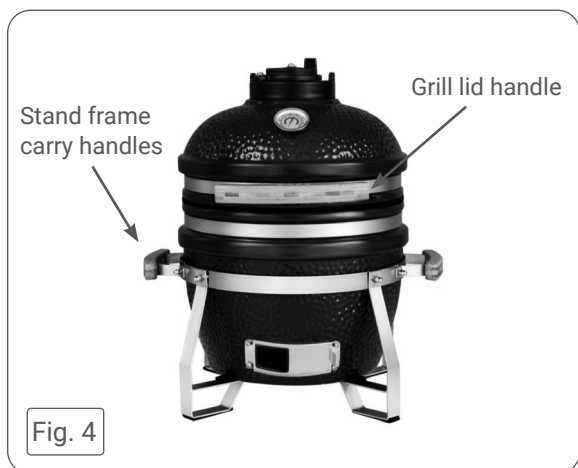

- **Step 5.**
- Place the chimney/top regulator vent on the top of the grill. See Fig. 5.

Using your grill for the first time

- It is necessary to “cure” your grill when you use it for the first time, curing your ceramic charcoal barbecue is important for its long-term operation and care. Avoiding the curing procedure could lead to damage on the unit. If the first “burns” are too hot, they could damage the felt gasket seal before it has had the chance to mature with use.
- **DO NOT** remove the grey felt bead from the joining edging of the base and the lid, This gasket provides the air seal for the grill around the centre.
- It is advised to do a longer slower burn in the your grill the first time you use it or before you first cook with your grill, this will allow the seals to cure and will help remove any smells or residues that may be in the grill following manufacture and transportation, it will ensuring a better first cooking experience as well as prolonging the life of the materials in the grill. This process provides an excellent opportunity for you to see how your Kamado grill burns and how to control the temperature, this grill offers a large temperature range and excellent controllability so take this opportunity to learn how to safely control your grill.
- After the first couple of times you use your grill when it is cool check all the fixings and hardware and tighten where required, use a small amount of light oil or **WD40** to lubricate the hinge and hasp lock, this process should be repeated regularly to ensure the good working condition of your grill.
- **Warning! High temperature cooking - Get into the habit of opening your grill by 3-5cm and pausing for two or three seconds before fully opening the grill, introducing a large amount of air quickly could cause the grill to dangerously flare up this is more likely at higher temperatures.**

Lighting your grill

- Open the lid and remove the grill, Open the bottom inlet vent fully (and the top exhaust vent in the hinging top section) fully. Fill the inner ceramic fire bowl with a good quality charcoal to approximately 3-5cm above the ventilation holes. Using a natural solid fire lighter block and place into the charcoal lumps.
- Leave the lid open for 5-10 minutes until the charcoal is well alight. It is recommended that the charcoal is not moved to stoked after it is well alight, you will get a more even and better heat if they are left alone. Close the lid and set the vents as described in the section “Regulating the temperature”.
- **DO NOT** not begin cooking with your grill until the charcoal pieces have a good coating of ash on them, only handle grill components with heat resistant gloves.
- Close the lid to allow the temperature within the grill to rise, ensure the air vents top and bottom are initially open, you can now begin to regulate the flow of air through the grill and so the temperature.
- Try not to add fuel to the grill during cooking as this will alter the temperature dramatically and affect the evenness and length of the cooking process.
- For the best results we recommend you use natural charcoal or untreated wood for cooking and untreated wood chips for smoking for the best possible flavours.

Regulating the temperature

- Open vents will allow a greater flow of air and create **HIGHER** temperatures.
- Nearly closed vents will allow less air through and result in **LOWER** temperatures.
- Closed vents will almost completely remove the flow and air and will slowly extinguish the grill.
- Once the grill begins to get up to your desired temperature (normally between 150°C and 200°C) reduce both the upper and lower vents down to a minimal level, allowing the grill to stay alight but maintain temperature.
- Fine tune your temperature by adjusting from there, always try to keep the upper and lower vents in unison (both half open, both a quarter open and so on).
- When the thermometer indicates the desired temperature, you can start grilling.

Extinguishing

- After you have finished cooking do not add any further fuel, close the lid and shut of the air vents to starve the fire of oxygen and allow the grill to die naturally and cool slowly.
- Never try to cool the fire with water or any other artificial means as this can damage the grill components and ceramic liners.

Storage

- When not in use, and if stored outside, cover the ceramic charcoal barbecue once completely cooled with a suitable rain cover.
- It is recommended the ceramic charcoal grill be stored under cover in a garage or shed when not being used for long periods of time.

Cleaning and Maintenance

- Charcoal can be reused if you have unspent fuel left in your grill from a previous use, although, always ensure the fire bowl is cleaned of ash, spent fuel and other debris which may restrict airflow before relighting.
- Vents, grills and air holes must be kept clear and cleaned before each use, this will maximise your Kamado’s efficiency and give you the most control.
- Outside surfaces can be wiped down with a damp cloth or sponge using a mild non abrasive detergent, ensure the grill is dried well before use.
- The inner surfaces of the grill will self clean during the heating and cooling process, although food debris can be brushed down with a stiff non abrasive brush.
- The ceramic surfaces can be wiped over the a **DRY** soft cloth or brush **DO NOT** use water or other fluids, ceramics can be porous and if heated could crack, ensure all components are cool before starting and dried thoroughly before being assembled back into the grill.

BASIC COOKING ADVICE

- This Kamado grill offers you the opportunity to enhance your grilling skills with great control and temperature retention, you can enjoy the subtle tastes and aromas of grilling and smoking over an open fire to deliver wonderfully prepared foods.
- The oval shape of the Kamado causes the hot air to circulate, because of the design you have far more control over the supply of oxygen yourself in a simple way, you are always in charge of the temperature in your grill. This makes it easy to sear and grill meats and then lower the temperature and allow it to cook on at a lower temperature.
- Having great control over the air through your grill means you burn a lot less charcoal allowing for much longer lower temperature cooks.
- With the addition of wood chips you can ensure that not only meat and the fish but also the pizza or bread you bake on the pizza stone get a smoky aroma and taste. You can even make desserts. Think of grilled pineapple, or a creamy brownie.

General Food Safety

- Read and follow this advice when cooking on your ceramic charcoal grill:
- **DO NOT** begin cooking until the fuel has a coating of ash.
- Before cooking, ensure grill surfaces and tools are clean and free of old food residues.
- Always wash your hands before and after handling uncooked meat, and before eating.
- **DO NOT** use the same utensils to handle cooked and uncooked foods.
- Always keep raw meat away from cooked meat, and other foods.
- Ensure all meat is cooked thoroughly before eating.

Smoking

- Always follow the cooking temperature guide stated in this instruction manual.
- Always use heat-resistant gloves when handling hot ceramics or cooking surfaces.
- Light the lump charcoal according to the lighting instructions in this manual.
- **DO NOT** move or stoke the coals once lit.
- Open the bottom vent fully and leave the lid open for about 10 minutes to build a small bed of hot embers.
- Monitor the ceramic charcoal barbecue until it has risen to the desired temperature.
- Leave the bottom vent slightly open. Close the top vent and continue to check the temperature for a few more minutes.
- Using heat-resistant gloves, sprinkle the wood chips in a circle over the hot charcoal.
- You are now ready to use the ceramic charcoal barbecue to begin smoking food.
- **Tip:** Soak wood chips or cooking planks in water for 15 minutes to prolong the smoking process.
- **LOW TEMPERATURE COOKING**
- Light the lump charcoal according to the lighting instructions, do not move or stoke the coals once lit.
- Open the bottom vent fully and leave the lid open for about 10 minutes to build a small bed of hot embers.
- Always monitor the charcoal barbecue until it has risen to the desired temperature.
- Fully close the bottom vent to maintain the temperature, you are now ready to use the ceramic charcoal barbecue for cooking.
- **HIGH TEMPERATURES**
- Light the lump charcoal according to the lighting instructions, close the lid and fully open the top and bottom vents.
- Close the top vent halfway and continue to check the temperature for a few more minutes.
- You are now ready to use the ceramic charcoal grill for cooking.
- **SLOW COOK / SMOKE (83 °C - 108 °C / 180 °F - 225 °F)**
- Beef brisket: 4.5 hours per kg
- Pulled pork: 4.5 hours per kg
- Whole chicken: 3-4 hours
- Ribs: 3-5 hours
- Roasts: 9+ hours

TOP VENT  BOTTOM VENT  ● OPEN ○ CLOSED

- **GRILL / ROAST / BAKE (163 °C - 191 °C / 325 °F - 375 °F)**
- Seafood (crab, lobster, shrimp): until opaque & firm
- Seafood (clams, oysters): until shells open
- Fish: 15-20 minutes
- Pork tenderloin: 15-30 minutes
- Chicken pieces: 30-45 minutes
- Whole chicken: 1-1.5 hours
- Leg of lamb: 3-4 hours
- Turkey: 2-4 hours
- Ham: 2-5 hours

TOP VENT  BOTTOM VENT  ● OPEN ○ CLOSED

- **SEAR (260 °C - 330 °C / 500 °F - 625 °F)**
- Scallops: until opaque & firm
- Steak: 5-8 minutes
- Pork chops: 6-10 minutes
- Burgers: 6-10 minutes
- Sausages: 6-10 minutes

TOP VENT  BOTTOM VENT  ● OPEN ○ CLOSED

Accessories

- A number of useful accessories are available for your Kamado grill to be purchased separately from Dellonda.

• Troubleshooting

- If you are having problems lighting the grill check to ensure there is a good flow of air through the unit, make sure the top and bottom vents are fully open and there is nothing blocking the vents or air holes in the ceramic liner.
- Once the fire is alight ensure the bottom vent and the lid are left open for at least 10 minutes to build a bed of hot embers.
- If the grill will not stay alight or won't generate enough heat check to ensure you have filled the grill with enough fuel, if not add charcoal and begin the process to build a bed of hot embers again.
- To prevent a back-draft or flare ups that may cause injury, it is advised you only slightly open the lid and then pause for a few seconds to allow the air to enter to body of the grill safely
- Changes or cracks to ceramic body.
- Spiders web pattern in the face of the ceramic is different to a crack in the ceramic. This crazing does not affect the performance of the grill and is part of the curing process.

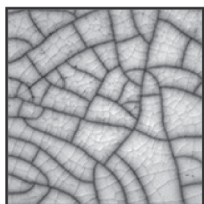

Environment Protection and Waste Protection and Electrical Equipment Regulations (WEEE)

Recycle unwanted packaging materials. When this product is no longer required, or has reached the end of its useful life, please dispose of it in an environmentally friendly way. Drain any fluids (if applicable) into approved containers, in accordance with local waste regulations. Under the Waste Batteries and Accumulators Regulations 2009, Dellonda would like to inform the user that this product contains one or more batteries. It is our policy to continually improve products and we reserve the right to alter data, specifications and parts without prior notice. No liability is accepted for incorrect use of this product. Guarantee is 12 months from purchase date, proof of which is required for any claim.

Dellonda Limited

Kempson Way, Suffolk Business Park, Bury St Edmunds, Suffolk. IP32 7AR

 01284 757575  support@dellonda.co.uk  www.dellonda.co.uk