

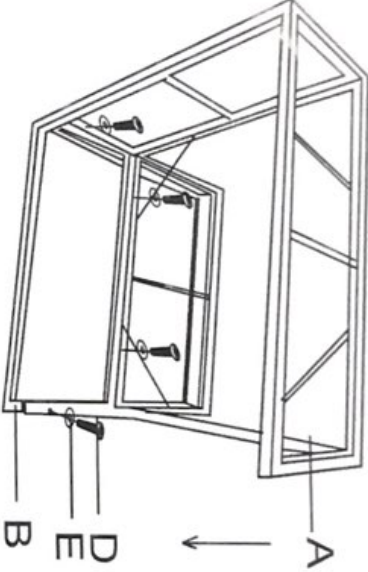

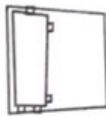

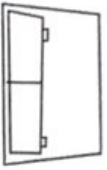





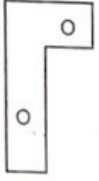

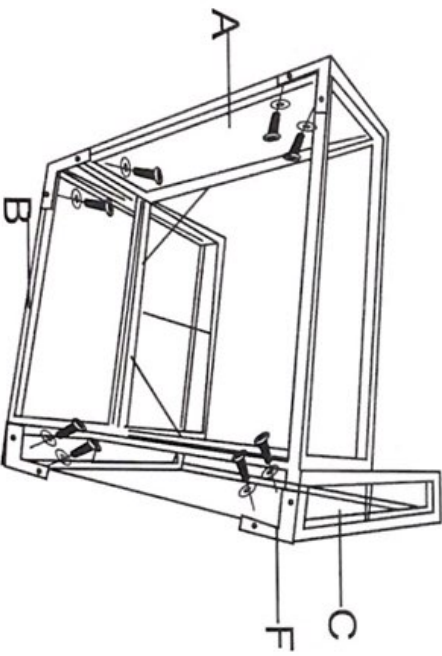
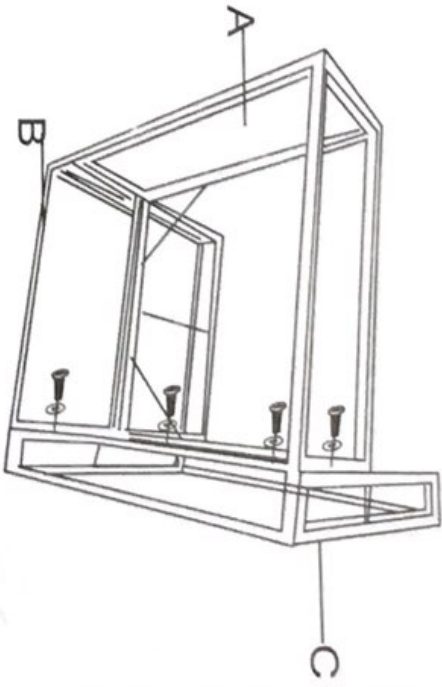
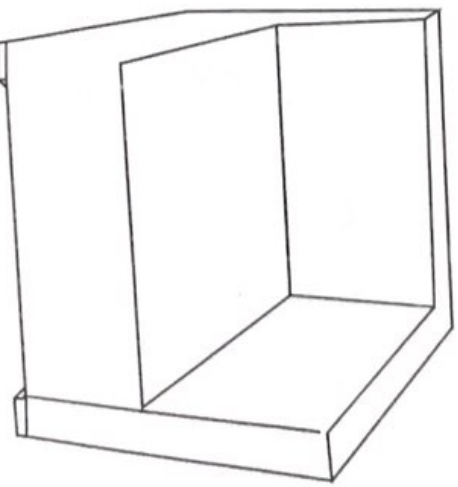

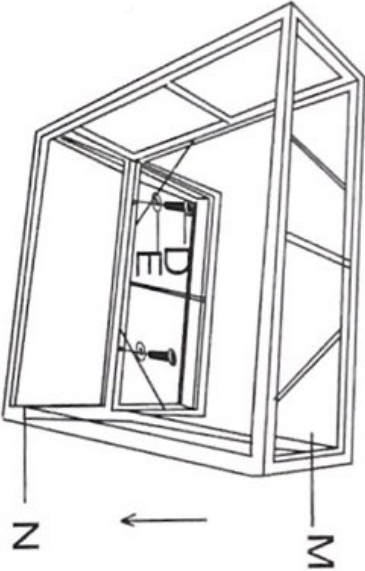
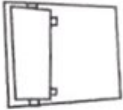
ASSEMBLY INSTRUCTION

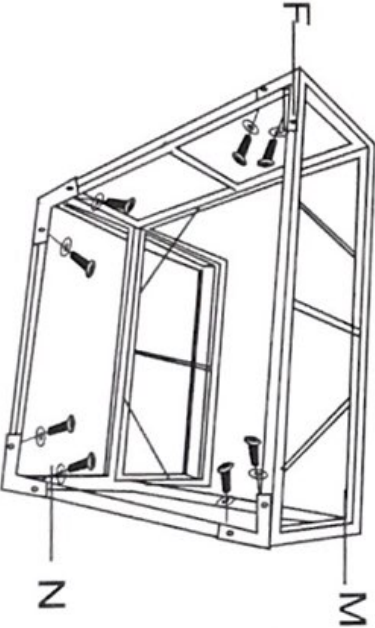
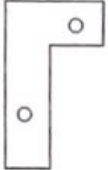
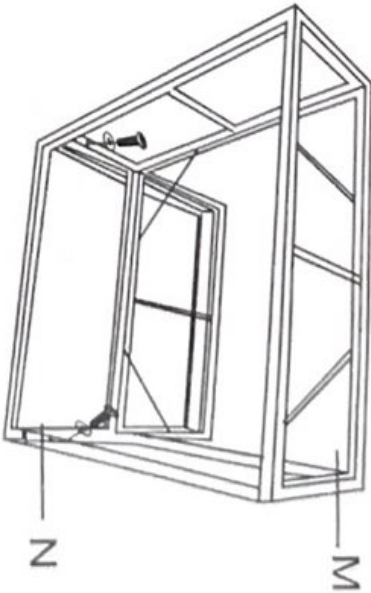
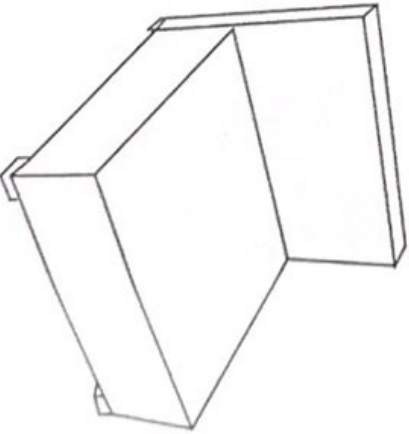
| | | |
|--|---|--|
| <p>AX1</p>  | <p>STEP1</p>  | <p>BX1</p>  |
| <p>CX1</p>  | | <p>DX16</p>  <p>M6X40mm</p> |
| <p>EX16</p>  | <p>FX4</p>  | <p>GX1</p>  |
| <p>STEP3</p> <p>Tight all the screws 60% first then tight to 100%</p>  | <p>STEP2</p>  | |
| <p>STEP4</p>  | | |

ASSEMBLY INSTRUCTION

| | | |
|---|--|--|
| <p>MX1</p>  | <p>STEP1</p>  | |
| <p>NX1</p>  | | |
| <p>EX12</p>  | <p>STEP3</p> <p>Tight all the screws 60% first then tight to 100%</p>  | |
| <p>FX4</p>  | | |
| <p>STEP2</p>  | | <p>STEP4</p>  |

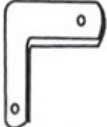
OTTOMAN

| | |
|-----|---|
| A*1 |  |
| E*8 |  M6X40MM |
| F*8 |  |
| G*4 |  |
| I*1 |  |

STEP1

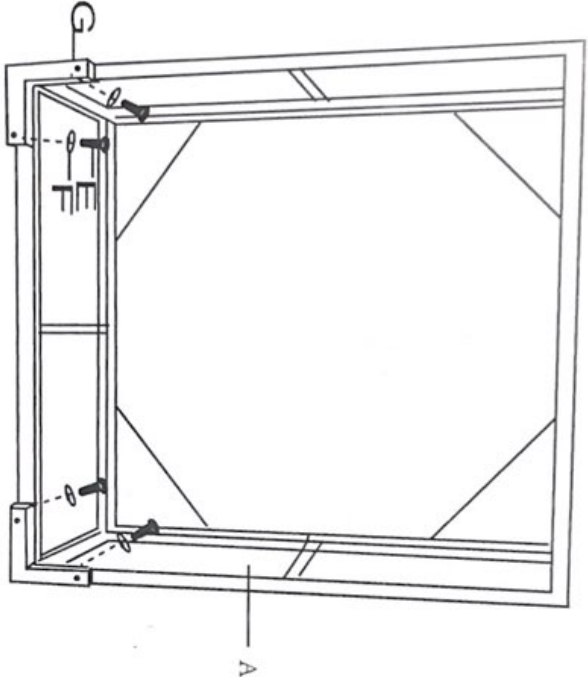

Tight all the screws to 60% first,
then tight to 100%.

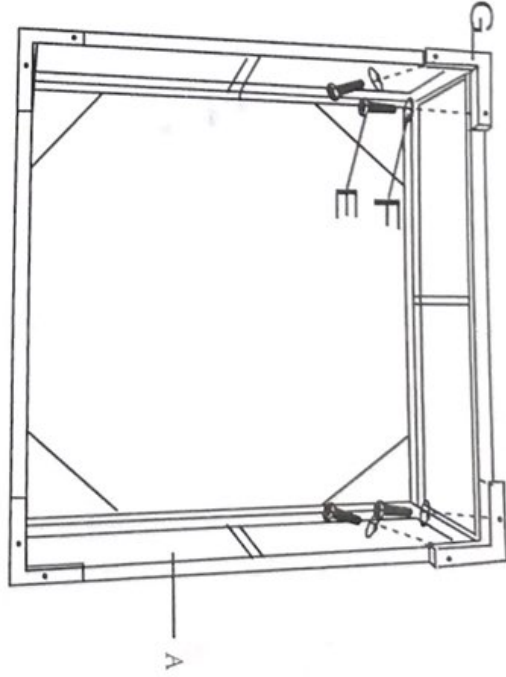

STEP2

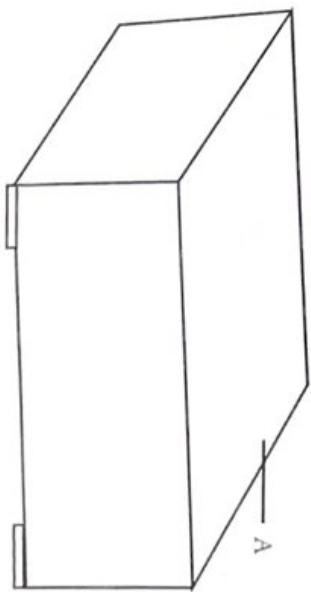

STEP3

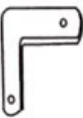

COFFEE TABLE

- A*1 
- E*8 
M6X40MM
- F*8 
- G*4 
- I*1 