

## MODEL : B155

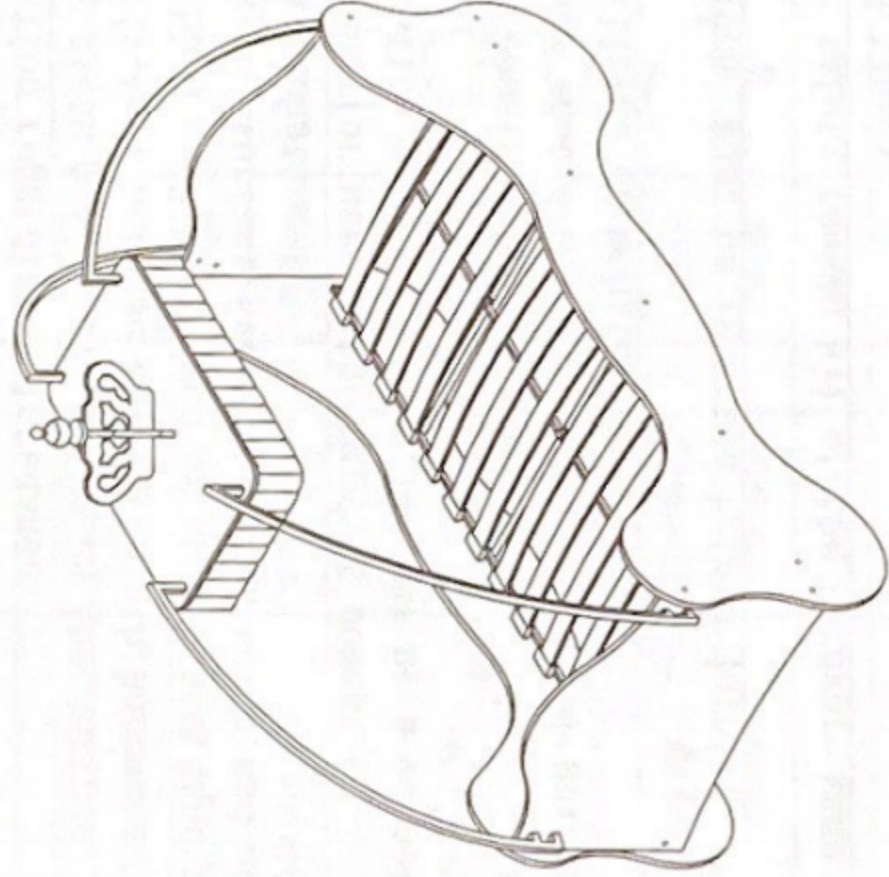

ASSEMBLE DIFFICULTY

1 2 ③ 4 5



2/11

-User Age:  
-Standard Of Paint:

36 Months Or Above.  
EN1725:1998  
EN1022:2005  
EN71-1:2014  
EN71-3:2013+A1:2014

IMPORTANT, RETAIN FOR FUTURE REFERENCE: READ CAREFULLY

-Information regarding maintenance  
Use dry, clean & soft cloth rub on the surface regularly; must not use any wet cloth, hardware or any hard material (such as keys, knife, sand-paper) rub on the surface. Keep away from water and any chemical substances.

-Conditions for use of the product domestic  
-Installation only to be carried out by a competent person  
-Article consists swallowable small parts, children  $\leq 3$  years should not be without parental guidance (surveillance or monitoring)

-Screw lock must be inserted before joining

-For the safety reason all of the hardware must be screwed tidely.











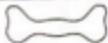

-This Product must be assembled by adult

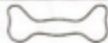
To avoid surface damage, tight all serew must not use over 5Nm power.

Use only mattress which is 74"-75" long, 37.5"-38.5" wide and 4"-6" height.

3/11

## DESCRIPTION OF COMPONENT

ITEM NO	WORK PIECE DESCRIPTION	MEASUREMENT	QTY	COLOUR	SHAPE	PACK IN BOX
(1)	SIDE PANEL(L)	2134*786*15	1	PURPLE		1/3
(2)	U SHAPED IRON	1910*15*15	3	SILVER		1/3
(3)	SUPPORT POLE	920*25*25	5	WHITE		1/3
(4)	DECORATE PIECE	355*207*15	2	GOLDEN		1/3
(5)	SIDE PANEL(R)	2134*786*15	1	PURPLE		1/3
(6)	TOP PANE	805*500*12	1	WHITE		2/3
(7)	FRONT PANEL	920*668*15	1	PURPLE		2/3
(8)	BACK PANEL	920*668*15	1	PURPLE		2/3
(9)	PLYWOOD SLAT	918*62*12	13	WHITE		3/3
(10)	SIDE RALL	1038*750*20	4	PURPLE		3/3
(11)	SPHERE	110*50*50	1	YELLOW		3/3
(12)	HARDWARE	216*114*57	1	BROWN		3/3
(13)	PINK CURTAIN	2524*32*32	1	PINK		3/3

MODEL: B155 (920\*1920)



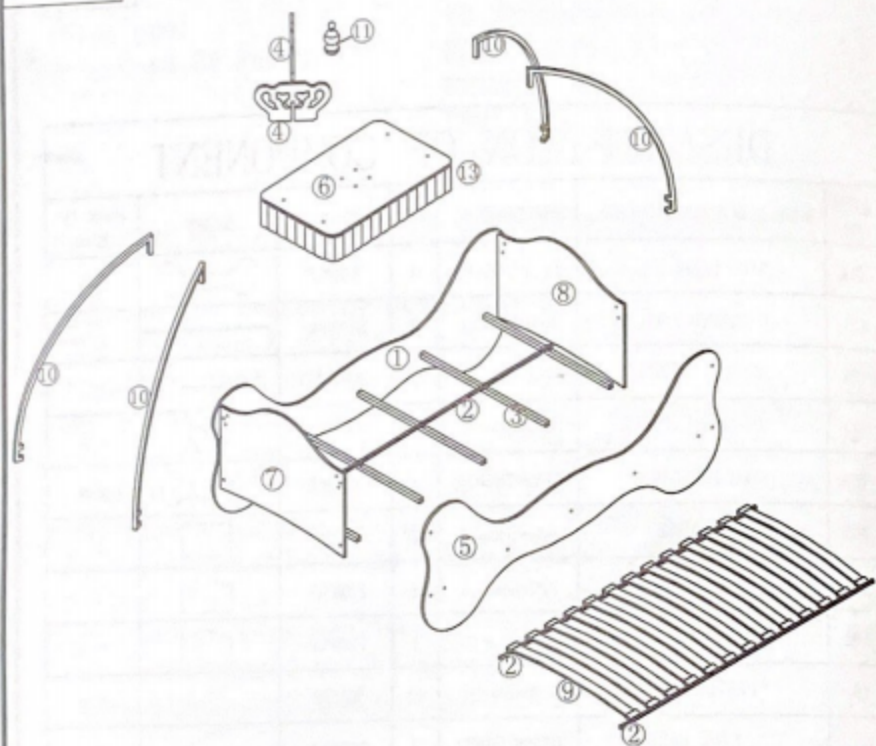

A	B	C	D	E	F	G
M6*50 QTY:22	QTY:12	QTY:18	QTY:5	M6*35 QTY:12	M8*69 QTY:1	QTY:26

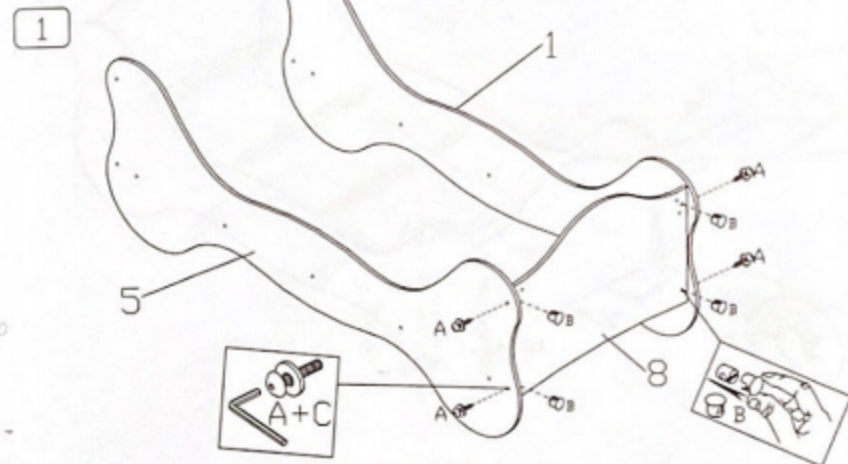

A	M6*50 QTY:4	B	QTY:4	C	QTY:4
---	----------------	---	-------	---	-------

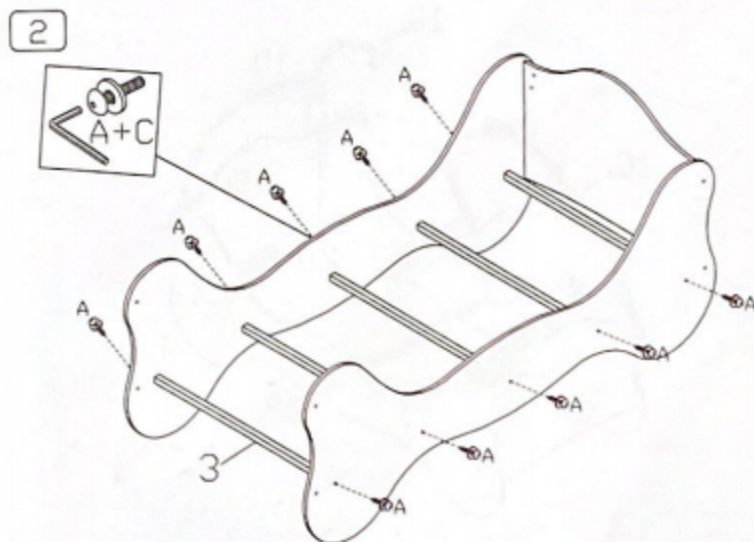

A	M6*50 QTY:10	C	QTY:10
---	-----------------	---	--------

6/11

3

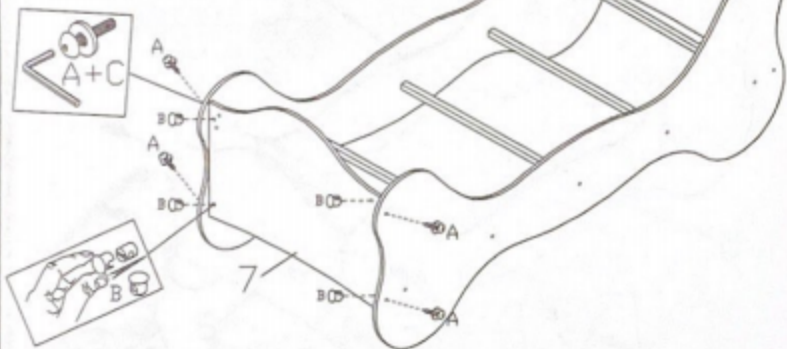

A  M6\*50 QTY:4

B  QTY:4

C  QTY:4

4

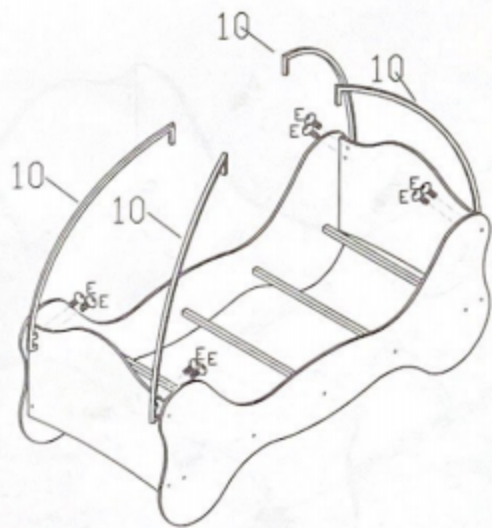

E  M6\*35 QTY:8

7/11

5

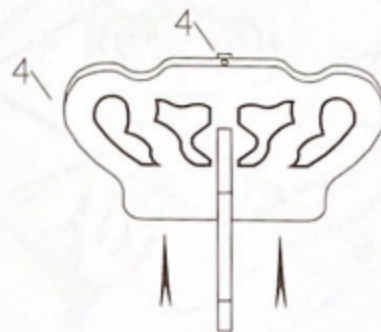

6

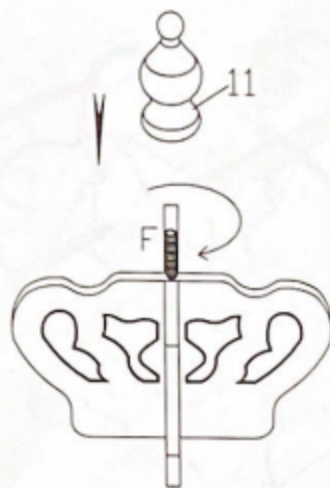

F  M8\*69 QTY:1



8/11

7

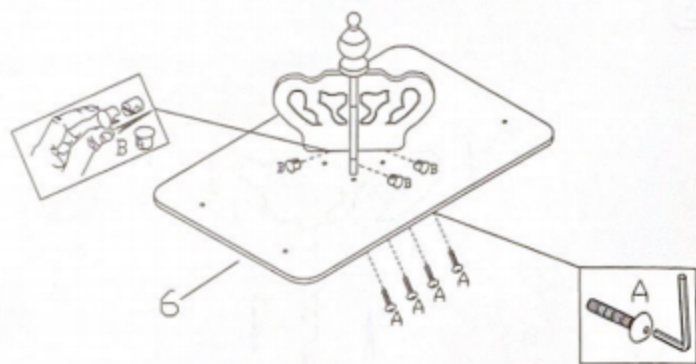

A

M6\*50  
QTY:4

B



QTY:4

8

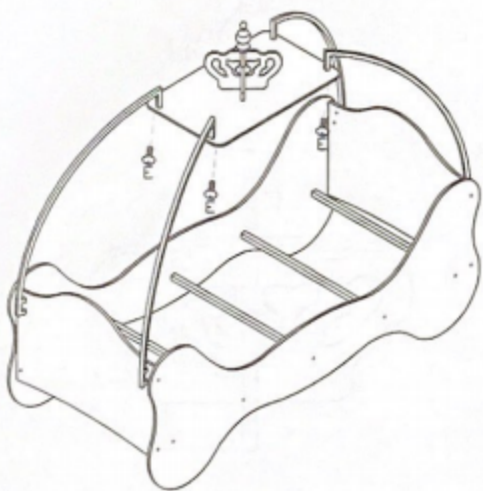

E

M6\*35  
QTY:4

9/11

9

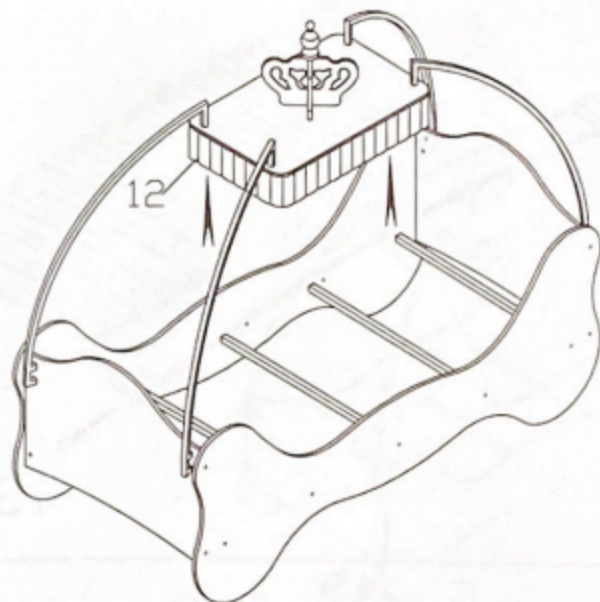

10

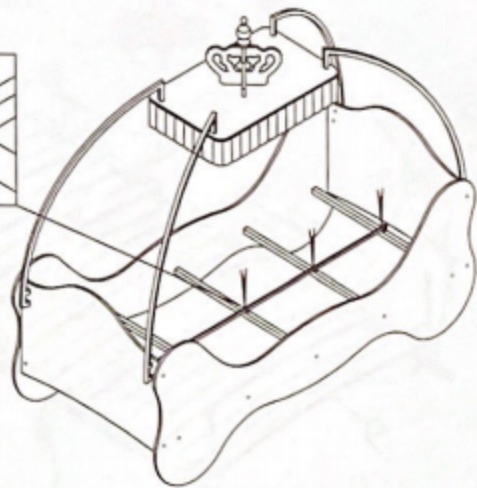
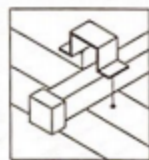

D



QTY:5

10/11

11

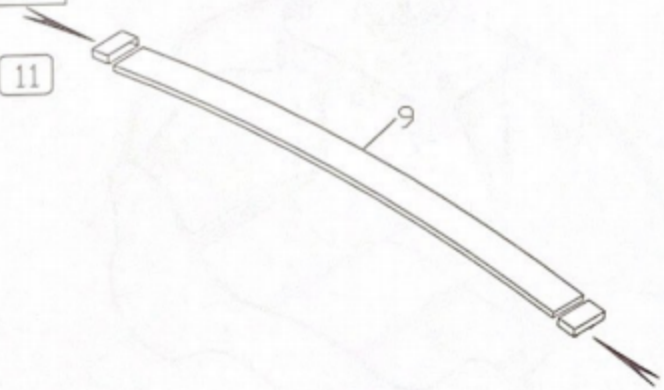

13X

G



QTY:26

12

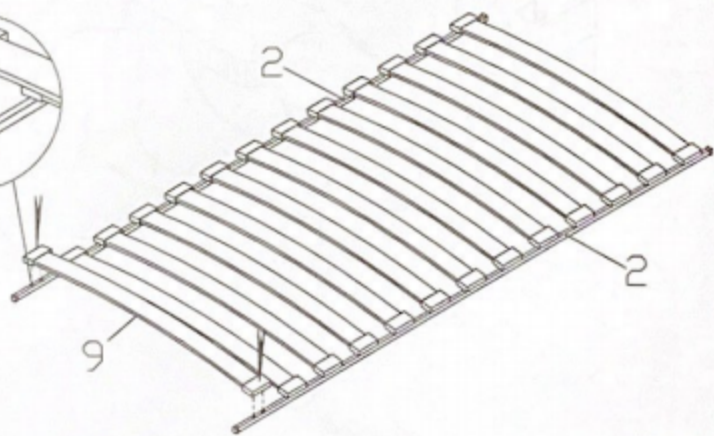

13X

11/11

13

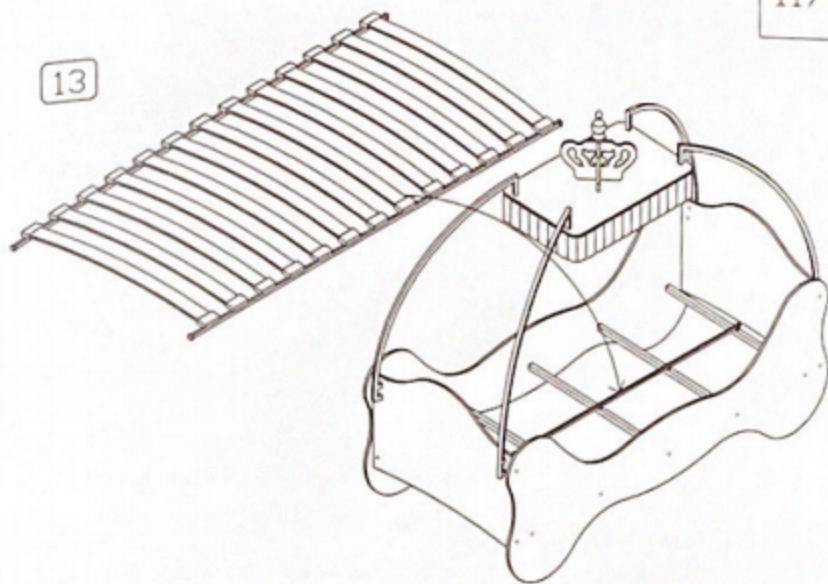

14

