

96.513

Addit footrest - adjustable 513

Footrests support the legs and indirectly aid the lower back muscles that way, making it easier to sit up straight. This practical footrest is adjustable in height and angle and has four different settings.

- Attractive design
- Height and angle adjustable over 4 different settings
- Height adjustable from 79 - 111 mm
- Dimensions (w x d x h): 450 x 348 - 371 x 79 - 111 mm
- Angle adjustment in 3 steps: 6°, 12°, 16° and 25°

addit

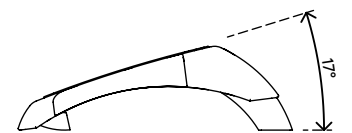
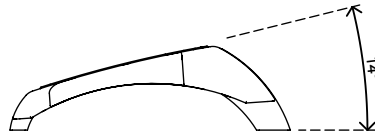
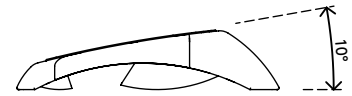
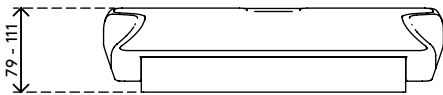
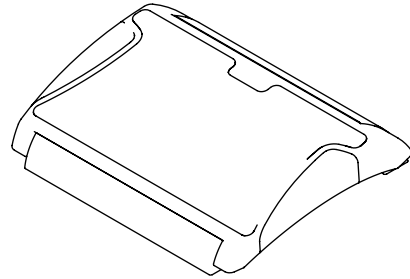
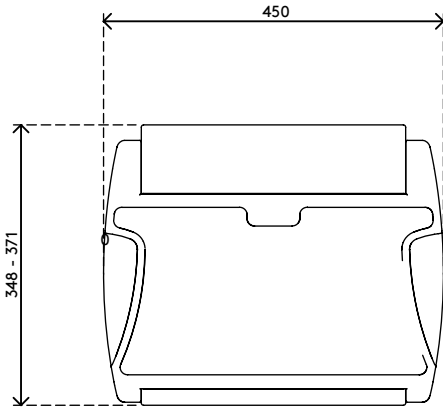

Addit footrest - adjustable 513

2016/11/22

96.513

 405 x 350 x 90 mm

 1 pcs

 black

 1,66 kg

 805410965136