



DRAPER®

230V
**ORBITAL
JIGSAW**

56760



CE

These instructions accompanying the product are the original instructions. This document is part of the product, keep it for the life of the product passing it on to any subsequent holder of the product. Read all these instructions before assembling, operating or maintaining this product.

This manual has been compiled by Draper Tools describing the purpose for which the product has been designed, and contains all the necessary information to ensure its correct and safe use. By following all the general safety instructions contained in this manual, it will ensure both product and operator safety, together with longer life of the product itself.

All photographs and drawings in this manual are supplied by Draper Tools to help illustrate the operation of the product.

Whilst every effort has been made to ensure the accuracy of information contained in this manual, the Draper Tools policy of continuous improvement determines the right to make modifications without prior warning.

1. TITLE PAGE

1.1 INTRODUCTION:

USER MANUAL FOR: 230V Orbital Jigsaw

Stock No: 56760

Part No: JS710D

1.2 REVISIONS:

Date first published October 2018.

As our user manuals are continually updated, users should make sure that they use the very latest version.

Downloads are available from: <http://drapertools.com/manuals>

Draper Tools Limited

Hursley Road

Chandler's Ford

Eastleigh

Hampshire

SO53 1YF

UK

Website: drapertools.com

Product Help Line: +44 (0) 23 8049 4344

General Fax: +44 (0) 23 8026 0784

1.3 UNDERSTANDING THIS MANUALS SAFETY CONTENT:

WARNING! – Information that draws attention to the risk of injury or death.

CAUTION! – Information that draws attention to the risk of damage to the product or surroundings.

1.4 COPYRIGHT © NOTICE:

Copyright © Draper Tools Limited.

Permission is granted to reproduce this publication for personal and educational use only. Commercial copying, redistribution, hiring or lending is prohibited.

No part of this publication may be stored in a retrieval system or transmitted in any other form or means without written permission from Draper Tools Limited.

In all cases this copyright notice must remain intact.

2. CONTENTS

1	TITLE PAGE	
1.1	INTRODUCTION	2
1.2	REVISION HISTORY	2
1.3	UNDERSTANDING THIS MANUAL	2
1.4	COPYRIGHT NOTICE.....	2
2	CONTENTS	
2.1	CONTENTS.....	3
3	WARRANTY	
3.1	WARRANTY.....	4
4	INTRODUCTION	
4.1	SCOPE	5
4.2	SPECIFICATION	5
4.3	HANDLING AND STORAGE	5
5	HEALTH AND SAFETY INFORMATION	
5.1	GENERAL SAFETY INSTRUCTIONS FOR POWER TOOL USE	6
5.2	ADDITIONAL SAFETY INSTRUCTIONS FOR JIGSAWS	7
5.3	RESIDUAL RISK	8
5.4	CONNECTION TO THE POWER SUPPLY	8
6	TECHNICAL DESCRIPTION	
6.1	IDENTIFICATION	9
7	UNPACKING AND CHECKING	
7.1	PACKAGING	10
7.2	WHAT'S IN THE BOX.....	10
8	PREPARING THE ORBITAL JIGSAW	
8.1	BLADE INSTALLATION AND REPLACEMENT	11
9	BASIC ORBITAL JIGSAW OPERATIONS	
9.1	TRIGGER SWITCH AND LOCKING BUTTON OPERATION.....	12
9.2	VARIABLE SPEED ADJUSTMENT.....	12
9.3	ORBITAL/PENDULUM ADJUSTMENT	12
9.4	GENERAL CUTTING	12
9.5	ANGLED/BEVEL CUTTING	13
9.6	PARALLEL GUIDE	14
9.7	DUST EXTRACTION.....	14
10	CUTTING BLADE GUIDE	
10.1	CUTTING BLADE GUIDE	15
11	MAINTENANCE AND TROUBLESHOOTING	
11.1	MAINTENANCE	16
11.2	TROUBLESHOOTING GUIDE.....	16
12	OPTIONAL ACCESSORIES	
12.1	OPTIONAL ACCESSORIES.....	17
13	DISPOSAL	
13.1	DISPOSAL.....	18
14	EXPLANATION OF SYMBOLS	
14.1	EXPLANATION OF SYMBOLS	19
	DECLARATION OF CONFORMITY	ENCLOSED

3. WARRANTY

3.1 WARRANTY

Draper tools have been carefully tested and inspected before shipment and are guaranteed to be free from defective materials and workmanship.

Should the tool develop a fault, please return the complete tool to your nearest distributor or contact

Draper Tools Limited, Chandler's Ford, Eastleigh, Hampshire, SO53 1YF. England.

Telephone Sales Desk: (023) 8049 4333 or Product Help Line (023) 8049 4344.

A proof of purchase **must** be provided with the tool.

If upon inspection it is found that the fault occurring is due to defective materials or workmanship, repairs will be carried out free of charge. This warranty period covering labour is 12 months from the date of purchase except where tools are hired out when the warranty period is 90 days from the date of purchase. The warranty is extended to 24 months for parts only. This warranty does not apply to any consumable parts, any type of battery or normal wear and tear, nor does it cover any damage caused by misuse, careless or unsafe handling, alterations, accidents, or repairs attempted or made by any personnel other than the authorised Draper warranty repair agent.

Note: If the tool is found not to be within the terms of warranty, repairs and carriage charges will be quoted and made accordingly.

This warranty applies in lieu of any other warranty expressed or implied and variations of its terms are not authorised.

Your Draper warranty is not effective unless you can produce upon request a dated receipt or invoice to verify your proof of purchase within the warranty period.

Please note that this warranty is an additional benefit and does not affect your statutory rights.

Draper Tools Limited.

4. INTRODUCTION

4.1 SCOPE

This hand held power tool is designed to cut wood and mild steel materials.

As part of our core range, this product is suitable for enthusiasts and tradespeople alike. Any application other than that it was intended for, is considered misuse.

4.2 SPECIFICATION

Stock No.	56760
Part No.	JS710D
Motor:	
Rated voltage	230V~
Rated frequency.....	.50Hz
Rated input710W
Strokes per minute (no load):.....	0 – 3000spm
Stroke length:	19mm
Orbital/pendulum settings.....	3
Cutting capacity:	
Wood	80mm
Steel	10mm
Bevel cutting angles	0 – 45°
Sound pressure level (LpA)*:	95.0dB(A)
Sound power level (LWA)**:	106.0dB(A)
Uncertainty (K):3dB(A)
Vibration level:	
Wood.....	13.21m/s ² , K=1.5m/s ²
Steel.....	5.63m/s ² , K=1.5m/s ²
Weight (machine only):.....	2.1kg

4.3 HANDLING AND STORAGE

- Care must be taken when handling this product.
 - Dropping this power tool could have an effect on its accuracy and could also result in personal injury. This product is not a toy and must be respected.
- Environmental conditions can have a detrimental effect on this product if neglected.
 - Exposure to damp air can gradually corrode components.
 - If the product is unprotected from dust and debris, components will become clogged.
 - If not cleaned and maintained correctly or regularly, the machine will not perform at its best.

* *Continuous A-Weighted Sound Pressure Level at the workstation in accordance to and declared according to EN60745.*

** *The typical A-Weighted noise level determined to EN60745.*

5. HEALTH AND SAFETY INFORMATION

5.1 GENERAL SAFETY INSTRUCTIONS FOR POWER TOOL USE

When using any type of power tool there are steps that should be taken to make sure that you, as the user, remain safe.

Common sense and a respect for the tool will help reduce the risk of injury.

Read the instruction manual fully. Do not attempt any operation until you have read and understood this manual.

Most important you must know how to safely start and stop this machine, especially in an emergency.

Keep the work area tidy and clean. Attempting to clear clutter from around the machine during use will reduce your concentration. Mess on the floor creates a trip hazard. Any liquid spilt on the floor could result in you slipping.

Find a suitable location. If the machine is bench mounted, the location should provide good natural light or artificial lighting as a replacement. Avoid damp and dust locations as it will have a negative effect on the machine's performance. If the machine is portable do not expose the tool to rain. In all cases do not operate power tools near any flammable materials.

Keep bystanders away. Children, onlookers and passers by must be restricted from entering the work area for their own protection. The barrier must extend a suitable distance from the tool user.

Unplug and house all power tools that are not in use. A power tool should never be left unattended while connected to the power supply. They must be housed in a suitable location, away locked up and from children. This includes battery chargers.

Do not overload or misuse the tool. All tools are designed for a purpose and are limited to what they are capable of doing. Do not attempt to use a power tool (or adapt it in any way) for an application it is not designed for. Select a tool appropriate for the size of the job. Overloading a tool will result in tool failure and user injury. This covers the use of accessories.

Dress properly. Loose clothing, long hair and jewellery are all dangerous because they can become entangled in moving machinery. This can also result in parts of body being pulled into the machine. Clothing should be close fitted, with any long hair tied back and jewellery and neck ties removed. Footwear must be fully enclosed and have a non-slip sole.

Wear personal protective equipment (PPE). Dust, noise, vibration and swarf can all be dangerous if not suitably protected against. If the work involving the power tool creates dust or fumes wear a dust mask. Vibration to the hand, caused by operating some tools for longer periods must be protected against. Wear vibration reducing gloves and allow long breaks between uses. Protect against dust and swarf by wearing approved safety goggles or a face shield. These are some of the more common hazards and preventions, however, always find out what hazards are associated with the machine/work process and wear the most suitable protective equipment available.

Do not breathe contaminated air. If the work creates dust or fumes connect the machine (if possible) to an extraction system either locally or remotely. Working outdoors can also help if possible.

Move the machine as instructed. If the machine is hand held, do not carry it by the power supply cable. If the product is heavy, employ a second or third person to help move it safely or use a mechanical device. Always refer to the instructions for the correct method.

Do not overreach. Extending your body too far can result in a loss of balance and you falling. This could be from a height or onto a machine and will result in injury.

Maintain your tools correctly. A well maintained tool will do the job safely. Replace any damaged or missing parts immediately with original parts from the manufacturer. As applicable, keep blades sharp, moving parts clean, oiled or greased, handles clean, and emergency devices working.

Wait for the machine to stop. Unless the machine is fitted with a safety brake, some parts may continue to move due to momentum. Wait for all parts to stop, then unplug it from the power supply before making any adjustments, carrying out maintenance operations or just finishing using the tool.

5. HEALTH AND SAFETY INFORMATION

Remove and check setting tools. Some machinery requires the use of additional tools or keys to set, load or adjust the power tool. Before starting the power tool always check to make certain they have been removed and are safely away from the machine.

Prevent unintentional starting. Before plugging any machine in to the power supply, make sure the switch is in the OFF position. If the machine is portable, do not hold the machine near the switch and take care when putting the machine down, that nothing can operate the switch.

Carefully select an extension lead. Some machines are not suitable for use with extension leads. If the tool is designed for use outdoors, use an extension lead also suitable for that environment. When using an extended lead, select one capable of handling the current (amps) drawn by the machine in use. Fully extend the lead regardless of the distance between the power supply and the tool. Excess current (amps) and a coiled extension lead will both cause the cable to heat up and can result in fire.

Concentrate and stay alert. Distractions are likely to cause an accident. Never operate a power tool if you are under the influence of drugs (prescription or otherwise), including alcohol or if you are feeling tired. Being disorientated will result in an accident.

Have this tool repaired by a qualified person. This tool is designed to conform to the relevant international and local standards and as such should be maintained and repaired by someone qualified, using only original parts supplied by the manufacturer. This will ensure the tool remains safe to use.

5.2 ADDITIONAL SAFETY INSTRUCTIONS FOR JIGSAWS

- Hold the power tool by the insulated gripping surfaces, when performing an operation where the cutting accessory may contact hidden wiring or its own cord. A cutting accessory contacting a “live” wire may make exposed metal parts of the power tool “live” and could cause an electric shock to the operator.
- Use clamps or another practical way to secure and support the workpiece to a stable platform. Holding the workpiece by hand or against your body leaves it unstable and may lead to loss of control.

Changing blades

- Ensure the saw is unplugged before changing blades and take care to prevent entrapment of the fingers between the blade and the shoe. Ensure the blade is secure before use.
- Use the appropriate blade for the material being cut. Different blades are available from your Draper stockist.
- Only use blades in perfect working condition. Discard and replace any cracked or bent saw blades.

When sawing

- Use of the mains cable: Ensure the mains cable is kept well away from the saw blade and ensure an adequate electrical supply is close at hand so that the operation is not restricted by the length of the cable.
- Allow sufficient clearance beneath the work to ensure the blade does not come into contact with the floor, bench etc.
- Switching off: Never place the saw on a table or bench if it has not completely stopped. The saw blade will continue to operate for a short time after the trigger has been released to stop the saw.
- Cutting of pipes: Use caution when cutting hollow pipe and do not cut material where the blade can enter the pipe when fully retracted, this can cause the blade to strike the inside of the pipe causing the user to experience unexpected reaction forces.
- Cutting into walls: Do not cut through walls or cavities without checking for hidden electrical wires or water pipes.

5. HEALTH AND SAFETY INFORMATION

- Do not attempt to remove tool from work until the blade has completely stopped and allow time for it to cool before touching the blade immediately after use.
- Use clamps and vices to secure the workpiece where possible.
- Cutting sheet materials – Do not cut material less than at least twice the pitch of the saw blade. At least two teeth must be in contact with the work at all times.
- Beware foreign objects – When cutting pre-used wood, ensure all nails have been removed beforehand. Nails will damage the saw blade.
- Cooling agents – When cutting materials, always use a cooling agent, i.e. cutting/soluble oil.
- Do not attempt to saw small objects including those which cannot be properly secured. Always hold the saw with both hands.

5.3 RESIDUAL RISK

Important note: Although the safety instructions and operating manuals for our tools contain extensive instructions of safe working with power tools, every power tool involves a certain residual risk which can not be completely excluded by safety mechanisms. Power tools must therefore always be operated with caution!

5.4 CONNECTION TO THE POWER SUPPLY

Caution: Risk of electric shock. Do not open.

This appliance is supplied with a moulded 3 pin mains plug for your safety. The value of the fuse fitted is marked on the pin face of the plug. Should the fuse need replacing, ensure the substitute is of the correct rating, approved to BS1362 and ASTA or BS Kite marked.

ASTA 

BSI 

The fuse cover is removable with a small plain slot screwdriver. Ensure the fuse cover is replaced before attempting to connect the plug to an electrical outlet. If the cover is missing, a replacement must be obtained or the plug replaced with a suitable type.

If a replacement plug is to be fitted this must be carried out by a qualified electrician.

The damaged or incomplete plug, when cut from the cable should be disabled to prevent connection to a live electrical outlet.

This appliance is Class II† and is designed for connection to a power supply matching that detailed on the rating label and compatible with the plug fitted.

If an extension lead is required, use an approved and compatible lead rated for this appliance. Follow all the instructions supplied with the extension lead.

†*Double insulated* : This product requires no earth connection as supplementary insulation is applied to the basic insulation to protect against electric shock in the event of failure of the basic insulation.

IMPORTANT

If using an extension lead, follow the instructions that came with your lead regarding maximum load while cable is wound. If in doubt, ensure that the entire cable is unwound. Using a coiled extension lead will generate heat which could melt the lead and cause a fire.

6. TECHNICAL DESCRIPTION

6.1 IDENTIFICATION



- ① ON/OFF trigger switch.
- ② Continuous use locking button.
- ③ Quick change blade clamp.
- ④ Blade guard.
- ⑤ Blade support roller.
- ⑥ Parallel guide locking hex. bolts.
- ⑦ Base plate.
- ⑧ Orbital/pendulum speed adjustment switch.
- ⑨ Dust extraction outlet.
- ⑩ Bevel cutting adjustment locking bolt.
- ⑪ Hex. key/hex. key storage location.
- ⑫ Plastic dust guard.
- ⑬ Variable speed control.
- ⑭ Parallel guide.

7. UNPACKING AND CHECKING

7.1 PACKAGING

Carefully remove the product from the packaging and examine it for any sign of damage that may have happened during shipping. Lay the contents out and check them against the parts shown below. If any part is damaged or missing, please contact the Draper Help Line (the telephone number appears on the Title page) and do not attempt to use the product.

The packaging material should be retained at least during the warranty period, in case the machine needs to be returned for repair.

Warning!

- Some of the packaging materials used may be harmful to children. Do not leave any of these materials in the reach of children.
- If any of the packaging is to be thrown away, make sure they are disposed of correctly, according to local regulations.

7.2 WHAT'S IN THE BOX

As well as the main product, there are several parts not fitted or attached to it.

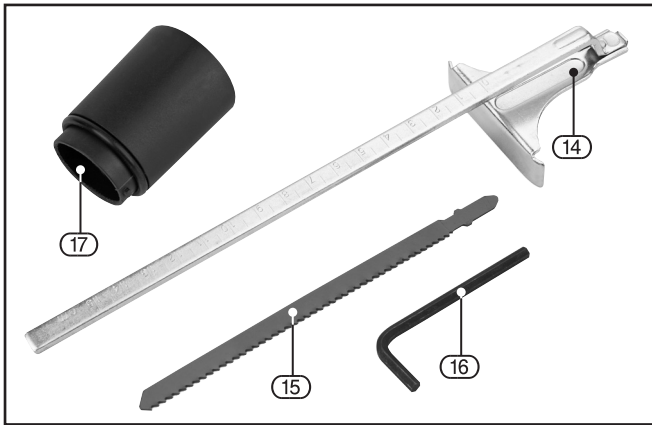

- (14) Parallel guide.
- (15) Wood cutting blade.
- (16) Hex. key.
- (17) Dust extraction adaptor.

8. PREPARING THE ORBITAL JIGSAW

8.1 BLADE INSTALLATION AND REPLACEMENT – FIGS.1 – 3

A jigsaw can be used for a variety of applications so the correct blade choice is important.

- If already in place, slide off the clear plastic dust guard (12).
- Twist and hold the quick change blade clamp (3).
- Slide the blade (15) up into the blade clamp (3) with the teeth facing forward.
- Release the quick change blade clamp to hold and lock the blade in place.

Note: This jigsaw will only fit Bayonet blades.

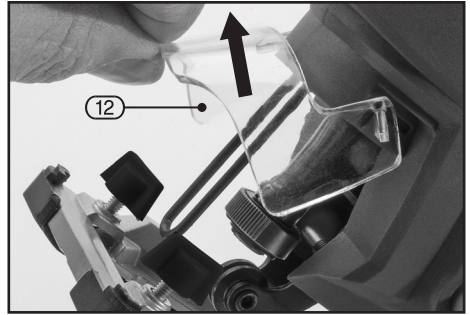

FIG.1

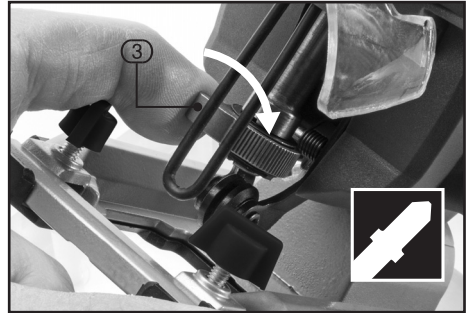

FIG.2

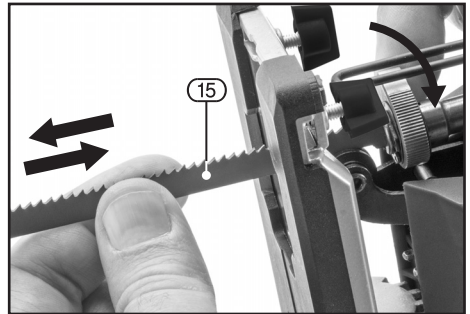

FIG.3

9. BASIC ORBITAL JIGSAW OPERATIONS

9.1 TRIGGER SWITCH AND LOCKING BUTTON OPERATION – FIG.4

To operate the saw:

- Depress the ON/OFF trigger switch (1).

For continuous saw operation:

- Depress the ON/OFF trigger switch (1).
- With the ON/OFF trigger switch depressed, press and hold the continuous use locking button (2).
- Release the ON/OFF trigger switch – the saw will now run in continuous operation.
- Depress the ON/OFF trigger switch (1) to stop the saw.

- Always wear ear defenders during use.

Caution: The saw blade may continue moving for a couple of seconds after the switch is released.

9.2 VARIABLE SPEED ADJUSTMENT – FIG.5

The variable speed adjustment dial (13) is conveniently located near the top of the handle section so that the operator can use the thumb to adjust the speed whilst the saw is in operation.

- There are 6 available speed settings, Position 1 being slowest, through to position 6, the fastest.

9.3 ORBITAL/PENDULUM ADJUSTMENT – FIG.6

The pendulum action acts on the rear of the blade to aid cutting performance and speed.

The 3 adjustable settings provide faster and more efficient cutting actions across a range of timber and plastic/PVC materials. The orbital motion of the cutting blade cuts through the workpiece in the upstroke, but doesn't drag across the workpiece on the down-stroke.

- Rotate the orbital/pendulum adjustment switch (8) to activate the required setting.
 - **Position 1** applies a small amount of pendulum action, resulting in a smoother finish cut – this will be at a slower cutting speed.
 - **Position 2** applies a medium amount of pendulum action.
 - **Position 3** has the most aggressive action, with a faster cut, but with the roughest finish.

9.4 GENERAL CUTTING

Important: Always wear safety goggles.

Important: Due to the shape of the body, this machine can be operated with only one hand, but for reasons of safety it is strongly advised to keep both hands on the machine during use.

Note: Applying pressure on the blade can overload the motor and result in damage.

- During cutting operations, make sure that the base is always resting on the workpiece.

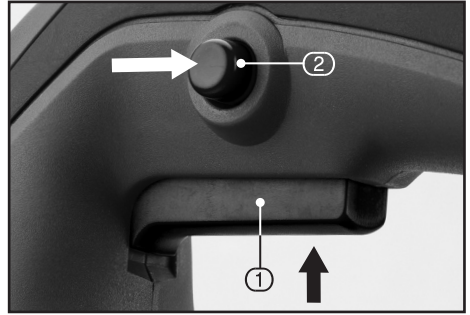

FIG.4

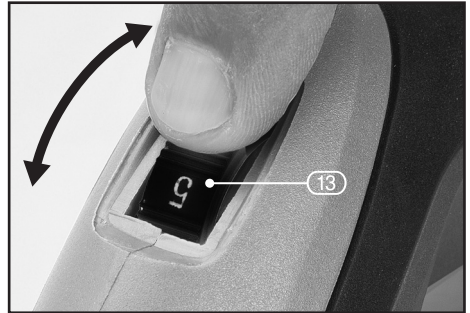

FIG.5



FIG.6

9. BASIC ORBITAL JIGSAW OPERATIONS

- When cutting metals, it is advisable to spread a few drops of oil on the cutting line to help keep the blade cool and help prolong the blade life.
- Sheets should always be rested on sufficient stable supports (chipboard or plywood tables). In this manner dragging is avoided and the elasticity of the material is compensated for.
- Small workpieces should be securely clamped in order that they remain in position during working operations (for example: fix in position with a clamp).

Note: When using longer blades and cutting thicker material, sideways pressure can cause the blade to bend and start to bevel the cut edge. Keep the blade straight to ensure a perpendicular cut.

Caution: Make certain the end of the blade does not contact obstructions below the workpiece as this will cause the saw to recoil and possibly result in the blade breaking and injury.

9.5 ANGLED/BEVEL CUTTING

– FIGS.7 – 9

For making bevel cuts the base can be adjusted to angles of 22° and 45° in either direction.

- Using the supplied hex. key (16), loosen the bevel cutting adjustment bolt (10) located on the underside of the base plate (7).
- Slide the base plate (7) backwards and adjust to the desired angle.
- Slide the base plate forwards, locking in position and re-tighten the hex bolt to secure.

Note: If using the jigsaw in conjunction with the parallel guide (17), it must be removed to carry out the above step.

Note: Convenient hex. key storage (11) is incorporated into the base of the power supply cable (fig.9).

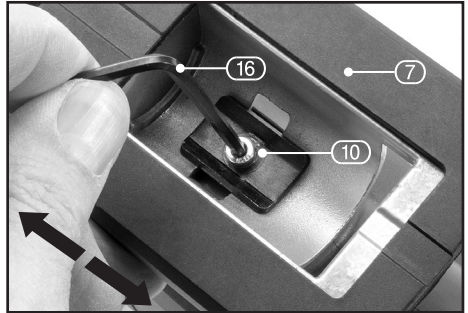

FIG.7

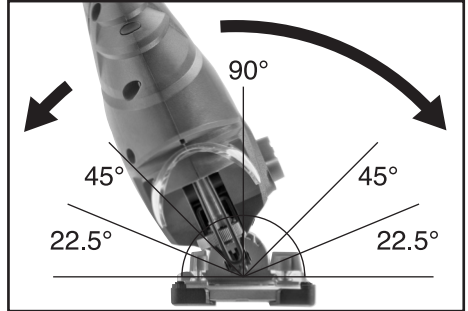

FIG.8

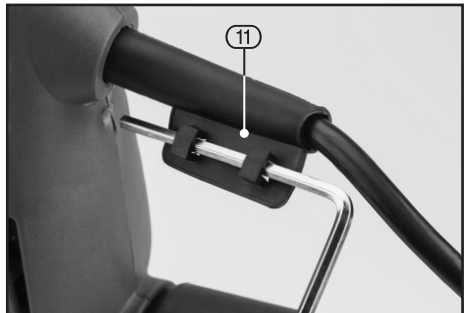

FIG.9

9. BASIC ORBITAL JIGSAW OPERATIONS

9.6 PARALLEL GUIDE – FIG.10

If the material to be cut has a straight edge, the supplied parallel guide (14) can be used as an aid to track the straight edge.

- Pass the parallel guide through the points in the base.
- Tighten the two parallel guide locking bolts (6) to secure the guide firmly.

Make a test cut on a scrap piece of timber prior to making any cuts on the work piece and adjust accordingly.

Note: When not in use, tighten bolts (6) to prevent them vibrating loose and getting lost.

9.7 DUST EXTRACTION – FIGS.11 – 12

Inhalation of dust particles can be detrimental to health. The dust extraction outlet (9) must be connected to a suitable dust extraction device.

- The saw is supplied with a dust extraction adaptor (17) that slots onto the dust extraction outlet (9). This enables the saw to be connected up to a suitable dust extraction device.

Warning! All wood dust (including dust from composites like chipboards and fibre boards etc.) is hazardous to health. It can affect the nose, the respiratory system and the skin. For example MDF (medium density fibreboard) which contains formaldehyde is a known carcinogen. In addition to the above measures a correctly fitted dust mask, suitable for the activity and in accordance to the relevant standard, must be worn.

- Contact Draper Tools for details of the comprehensive range of professional CE marked face masks available – all conforming to EN specifications.

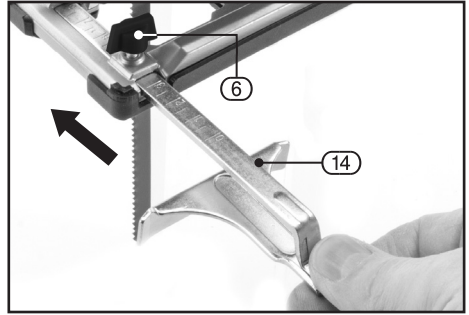

FIG.10

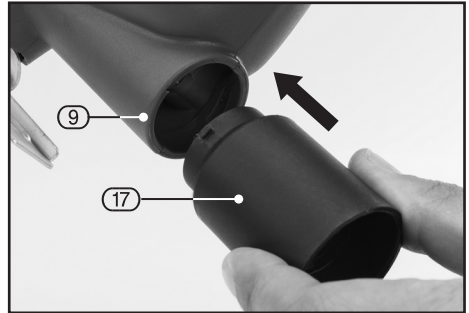

FIG.11

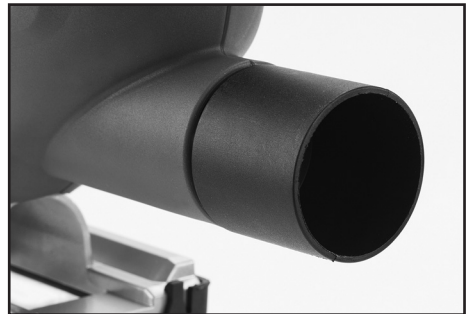

FIG.12

10. CUTTING BLADE GUIDE

10.1 CUTTING BLADE GUIDE

Orbital setting	Material	Blade type	TPI (teeth per inch)
0	Worktop, laminated board	Wood cutting blade	10 – 12 (Down-stroke cutting blade)
	Thin sheet metal	Metal cutting blade	14 – 24
1	Plastics/PVC	Wood cutting blade	10 – 12
	Scrolling/curved wood cutting	Scrolling wood blade	10 – 12
2	Plywood, decking, hardwoods	Wood cutting blade	6 – 12
3	General timber/softwoods	Wood cutting blade	6 – 10

11. MAINTENANCE AND TROUBLESHOOTING

11.1 MAINTENANCE

Regular inspection and cleaning reduces the necessity for maintenance operations and will keep your tool in good working condition.

The motor must be correctly ventilated during tool operation. Avoid blocking the air inlets and vacuum the ventilation slots regularly.

11.2 TROUBLESHOOTING GUIDE

Problem	Possible Cause	Remedy
Motor does not start.	1. Fuse.	1. Replace/reset 13 amp time delay fuse or circuit breaker.
	2. Unsure.	3. Return to an authorised service agent for diagnosis.
Poor cutting performance.	1. Saw blade blunt.	1. Replace saw blade.
	2. Saw blade incorrectly mounted.	2. Remove and refit saw blade as per instructions.
	3. Incorrect saw blade selection.	3. Seek advice on suitable saw blades.

12. OPTIONAL ACCESSORIES

12.1 OPTIONAL ACCESSORIES

A full range of accessories are available from Draper Tools.

Please visit our website for details: www.drapertools.com

13. DISPOSAL

13.1 DISPOSAL

- At the end of the machine's working life, or when it can no longer be repaired, ensure that it is disposed of according to national regulations.
- Contact your local authority for details of collection schemes in your area.

In all circumstances:

- Do not dispose of power tools with domestic waste.
- Do not incinerate.
- Do not dispose of WEEE* as unsorted municipal waste.



* *Waste Electrical & Electronic Equipment.*

14. EXPLANATION OF SYMBOLS

14.1 EXPLANATION OF SYMBOLS



Read the instruction manual.



Wear face mask and safety glasses.



Wear ear defenders.



Wear protective gloves.



Do not abandon into the environment.



Keep out of the reach of children.



Warning!



Bayonet fitting jigsaw blade.



Class II construction
(Double insulated).



WEEE –
Waste Electrical &
Electronic Equipment.

*Do not dispose of Waste Electrical
& Electronic Equipment in with
domestic rubbish.*

CONTACTS

Draper Tools Limited, Hursley Road,
Chandler's Ford, Eastleigh, Hampshire. SO53 1YF. U.K.

Help Line: (023) 8049 4344

Sales Desk: (023) 8049 4333

Internet: drapertools.com

E-mail: sales@drapertools.com

General Enquiries: (023) 8026 6355

Service/Warranty Repair Agent:

For aftersales servicing or warranty repairs, please contact the
Draper Tools Help Line for details of an agent in your local area.

YOUR DRAPER STOCKIST

TACH1018

©Published by Draper Tools Limited.

No part of this publication may be reproduced, stored in a retrieval system or transmitted in any form or by any means, electronic, mechanical photocopying, recording or otherwise without prior permission in writing from Draper Tools Ltd.