

CORRAPOL<sup>®</sup>-BT

Durable Bitumen **Corrugated Sheet**  
Technical Guide



## Waterproof Roofing Sheet

CORRAPOL®-BT is a Corrugated Bitumen impregnated sheet designed for waterproof roofing of sheds, log stores, garages and other outbuildings.

Available in several colours CORRAPOL®-BT sheets provide a roofing solution to suit many applications. CORRAPOL®-BT sheets are lightweight, easy to cut and quick to install.

Samples of CORRAPOL® sheets are readily available for testing and specification purposes.



### Common uses:

- ✓ Sheds
- ✓ Garages
- ✓ Log Stores
- ✓ Children's Playhouses

### Qualities:

- ✓ Lightweight
- ✓ Easy to Cut to Size
- ✓ Simple Overlap Joints
- ✓ Fast to Install



Black



Red

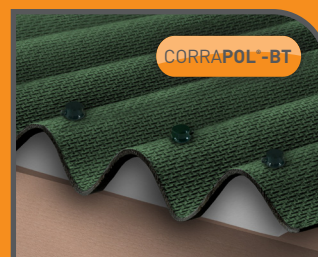

Green



Brown

## CORRAPOL®-BT : Full Roof Structure

Below is a typical apex roof scenario showing how the CORRAPOL®-BT system components are installed together for perfect results. The same methods and components can be used in most applications from Carports, Decking covers, BBQ shelters and other constructions.



### Fitting stages:

1. Fit the foam Eaves Fillers.
2. Next fit the CORRAPOL®-BT Rock n' Lock Side Flashing to the first corrugated sheet.
3. Fix the CORRAPOL®-BT Rock n' Lock Side Flashing with the stainless steel screws and flexible caps.
4. Then fix the sheets with the recommended CORRAPOL®-BT Superior Flexible Fixing.
5. Fit the Super Ridge Bar and Ridge End Caps with the Gaskets and Fixings.  
(Refer to the CORRAPOL®-BT Installation Guide)



**Fully constructed  
CORRAPOL®-BT roof**

## CORRAPOL®-BT : Sheets

CORRAPOL®-BT sheets are manufactured in four colours to suit a wide variety of colour schemes to give an aesthetically pleasing finished projects.

CORRAPOL®-BT: Sheets	Size	Code
BLACK Corrugated Bitumen Sheet	930 x 2000 mm	AC110BL
RED Corrugated Bitumen Sheet	930 x 2000 mm	AC110RD
GREEN Corrugated Bitumen Sheet	930 x 2000 mm	AC110GR
BROWN Corrugated Bitumen Sheet	930 x 2000 mm	AC110BR



Black

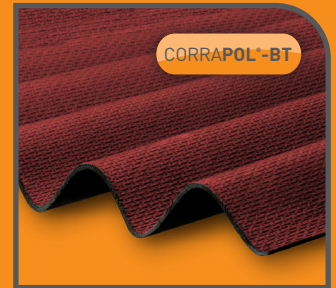

Red

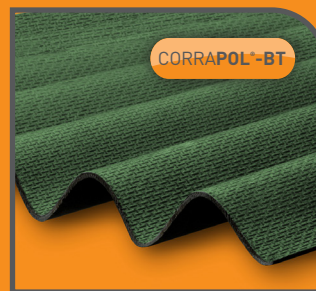

Green



Brown

## CORRAPOL®-BT : Rock n' Lock Side Flashing

The CORRAPOL®-BT Rock n' Lock Side Flashing is a world first that we have manufactured to help our Distributors' Customers easily finish one of the most challenging areas of any roof project; the gable. The Patent Pending and Registered Design allows users to quickly and easily create a robust, long-lasting side flashing to the gable end of any CORRAPOL®-BT roof, with a simple Rock n' Lock system.



Black



Red



Green



Brown

CORRAPOL®-BT: Rock n' Lock Side Flashing	Code
CORRAPOL®-BT Rigid Rock n' Lock Side Flashing 2m Black	AC220BL
CORRAPOL®-BT Rigid Rock n' Lock Side Flashing 2m Brown	AC220BR
CORRAPOL®-BT Rigid Rock n' Lock Side Flashing 2m Green	AC220GR
CORRAPOL®-BT Rigid Rock n' Lock Side Flashing 2m Red	AC220RE
CORRAPOL®-BT Rigid Rock n' Lock Side Flashing 3m Black	AC222BL
CORRAPOL®-BT Rigid Rock n' Lock Side Flashing 3m Brown	AC222BR
CORRAPOL®-BT Rigid Rock n' Lock Side Flashing 3m Green	AC222GR
CORRAPOL®-BT Rigid Rock n' Lock Side Flashing 3m Red	AC222RE
CORRAPOL®-BT Rigid Rock n' Lock Side Flashing 6m Black	AC228BL
CORRAPOL®-BT Rigid Rock n' Lock Side Flashing 6m Brown	AC228BR
CORRAPOL®-BT Rigid Rock n' Lock Side Flashing 6m Green	AC228GR
CORRAPOL®-BT Rigid Rock n' Lock Side Flashing 6m Red	AC228RE

## CORRAPOL®-BT : Three Stage Side Connection

This patented CORRAPOL®-BT Rock n' Lock system means the side flashing is locked in position providing a strong and aesthetically pleasing finish. The CORRAPOL®-BT Rock n' Lock Side Flashing is available in four colours to match the four sheet colour options.



## CORRAPOL®-BT : Super Ridge Bar

The CORRAPOL®-BT aluminium Super Ridge is another game changer in the corrugated market. Protecting the ridge of a roof is crucial and with the installation of the CORRAPOL®-BT Super Ridge you can add years of lifespan to your roof. Designed with integrated pre-formed foam gaskets to fit the corrugations of the CORRAPOL®-BT sheets, the CORRAPOL®-BT Super Ridge is an installer's dream. The patented design allows for a good variety of roof pitches with the gaskets being flexible enough to seal against the CORRAPOL®-BT sheets, and create a longer lasting superior ridge solution.

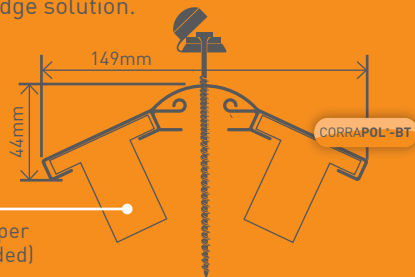

CORRAPOL®-BT Super Ridge Gasket (included)



CORRAPOL®-BT: Aluminium Ridge Bar	Code
CORRAPOL®-BT Aluminium Ridge Bar Set 2m Black	AC330BL
CORRAPOL®-BT Aluminium Ridge Bar Set 2m Brown	AC330BR
CORRAPOL®-BT Aluminium Ridge Bar Set 2m Green	AC330GR
CORRAPOL®-BT Aluminium Ridge Bar Set 2m Red	AC330RE
CORRAPOL®-BT Aluminium Ridge Bar Set 3m Black	AC332BL
CORRAPOL®-BT Aluminium Ridge Bar Set 3m Brown	AC332BR
CORRAPOL®-BT Aluminium Ridge Bar Set 3m Green	AC332GR
CORRAPOL®-BT Aluminium Ridge Bar Set 3m Red	AC332RE
CORRAPOL®-BT Aluminium Ridge Bar Set 6m Black	AC338BL
CORRAPOL®-BT Aluminium Ridge Bar Set 6m Brown	AC338BR
CORRAPOL®-BT Aluminium Ridge Bar Set 6m Green	AC338GR
CORRAPOL®-BT Aluminium Ridge Bar Set 6m Red	AC338RE



## CORRAPOL®-BT : Rock n' Lock Wall Side Flashing

The all new CORRAPOL®-BT Rock n' Lock Wall Side Flashing is another world first that we have manufactured to help installers complete a roofs gable when abutting up to a side wall. Allowing users to quickly and easily create a robust, long-lasting wall flashing the Patent Pending and Registered Design makes it simple to fix and seal the wall end of any CORRAPOL®-BT roof. With the signature Rock n' Lock fixing system the CORRAPOL®-BT Rock n' Lock Wall Flashing locks into place to create an extra level of waterproofing.



Black



Red

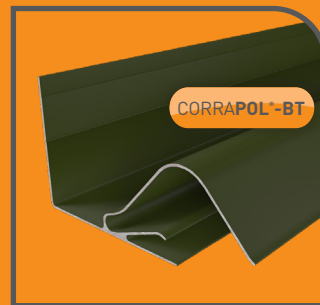

Green

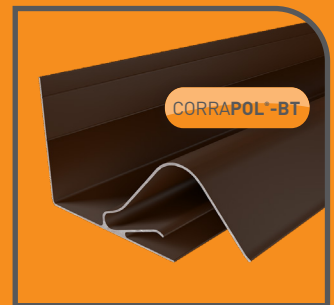

Brown

CORRAPOL®-BT: Rock n' Lock Wall Side Flashing	Code
CORRAPOL®-BT Rock n' Lock Wall Side Flashing 2m Black	AC420BL
CORRAPOL®-BT Rock n' Lock Wall Side Flashing 2m Brown	AC420BR
CORRAPOL®-BT Rock n' Lock Wall Side Flashing 2m Green	AC420GR
CORRAPOL®-BT Rock n' Lock Wall Side Flashing 2m Red	AC420RE
CORRAPOL®-BT Rock n' Lock Wall Side Flashing 3m Black	AC422BL
CORRAPOL®-BT Rock n' Lock Wall Side Flashing 3m Brown	AC422BR
CORRAPOL®-BT Rock n' Lock Wall Side Flashing 3m Green	AC422GR
CORRAPOL®-BT Rock n' Lock Wall Side Flashing 3m Red	AC422RE
CORRAPOL®-BT Rock n' Lock Wall Side Flashing 6m Black	AC428BL
CORRAPOL®-BT Rock n' Lock Wall Side Flashing 6m Brown	AC428BR
CORRAPOL®-BT Rock n' Lock Wall Side Flashing 6m Green	AC428GR
CORRAPOL®-BT Rock n' Lock Wall Side Flashing 6m Red	AC428RE

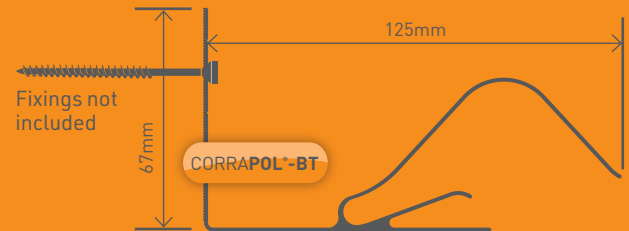

## CORRAPOL®-BT : Three Stage Wall Side Connection

This patented CORRAPOL®-BT Rock n' Lock system means the wall side flashing is locked in position providing a strong and aesthetically pleasing finish. The CORRAPOL®-BT Rock n' Lock Wall Side Flashing is available in four colours to match the four sheet colour options.



Tilt the CORRAPOL®-BT Rock n' Lock Wall Side Flashing to the side and fit the first corrugated sheet peak into the flashing.

Lock the CORRAPOL®-BT Rock n' Lock Flashing into place giving a waterproof and visually pleasing finish to the edge of your roof structure.

# CORRAPOL®-BT : Aluminium Super Ridge End Cap

Crafted with striking form, our all new CORRAPOL®-BT Super Ridge End Cap is designed to be the crowning element to every CORRAPOL®-BT Corrugated ridged roof. Shaped to add new level of waterproofing to the end of a CORRAPOL®-BT Super Ridge, the new Super Ridge End Cap helps protects one of the most crucial areas of installation and provides an unrivalled finish to user's roofs. Manufactured from aluminium, the new CORRAPOL®-BT Super ridge is very durable and adds extra longevity to the lifespan a roof. The simple and innovative location prongs ensure that installation is fast and easy for DIYers and installers alike.

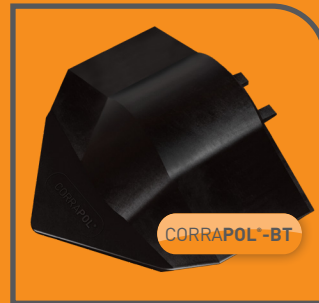

Black



Red



Green



Brown

CORRAPOL®-BT Super Ridge End Caps fit into the lower slot on both sides of the CORRAPOL®-BT Super Ridge bar.



CORRAPOL®-BT : Aluminium Ridge Bar End Cap	Code
CORRAPOL®-BT Super Ridge Endcap Black	AC340M
CORRAPOL®-BT Super Ridge Endcap Brown	AC340BR
CORRAPOL®-BT Super Ridge Endcap Green	AC340GR
CORRAPOL®-BT Super Ridge Endcap Red	AC340RE

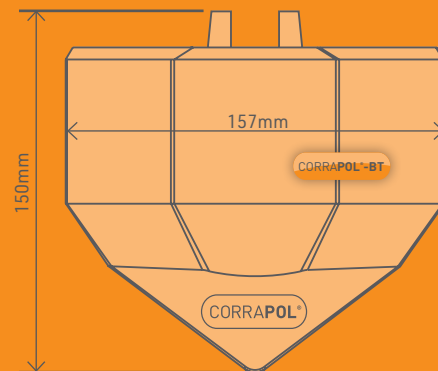

PLAN VIEW

CORRAPOL® Super Ridge End Cap fits into the lower slot of the CORRAPOL® Super Ridge bar.

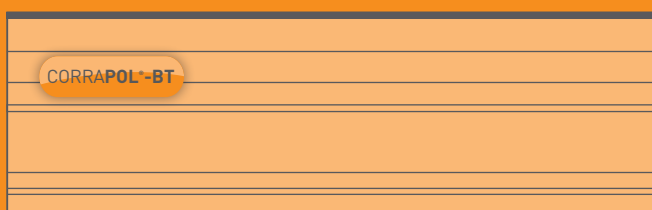

CROSS SECTION OF CORRAPOL® SUPER RIDGE BAR

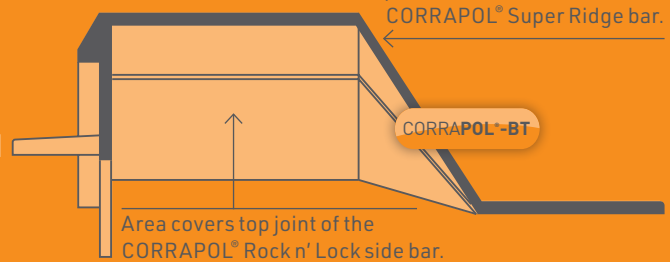

CROSS SECTION OF CORRAPOL® SUPER RIDGE END CAP

## CORRAPOL®-BT: Aluminium Top Wall Flashing

Our new CORRAPOL®-BT Top Wall Flashing is another innovation designed with ease of installation and quality finish in mind. With its unique bi-angled shape the Top Wall Flashing works with multiple roof pitches making it easy for any installer to add to their roof. The unique patented and/or Registered Design foam gaskets help create a firm seal on the CORRAPOL®-BT sheets below, whilst working with any pitch, ensuring strong waterproofing across the top of the roof. As with our other innovative aluminium components, the CORRAPOL®-BT Top Wall Flashing is manufactured to match the colours of the sheets in vibrant Red, Green, Black and Brown!

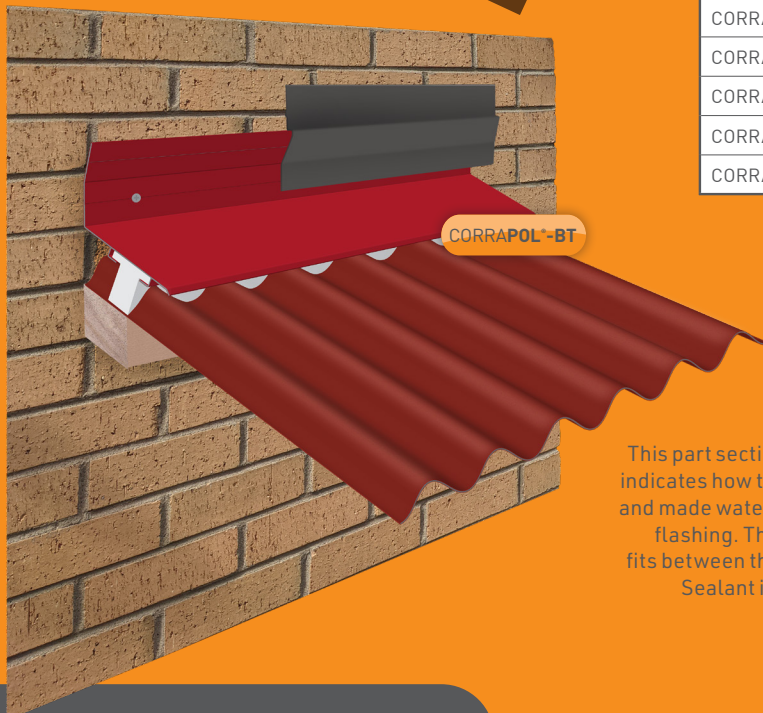
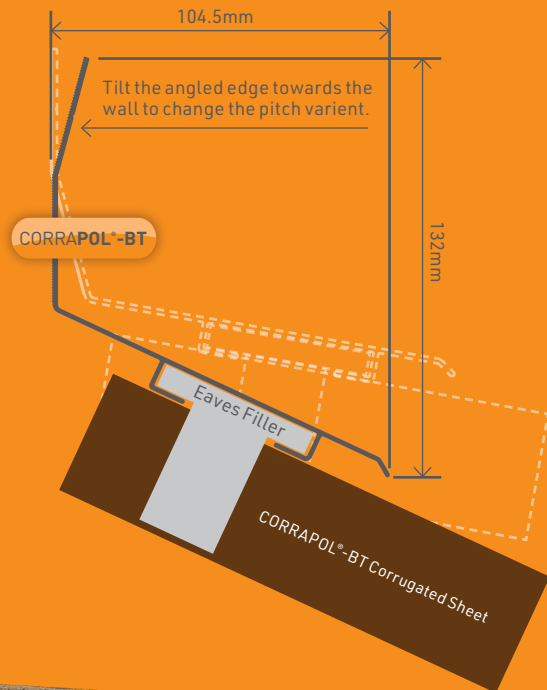

Black



Red



Green



Brown

CORRAPOL®-BT: Top Wall Flashing	Code
CORRAPOL®-BT Top Wall Flashing 2m Black	AC620BL
CORRAPOL®-BT Top Wall Flashing 2m Brown	AC620BR
CORRAPOL®-BT Top Wall Flashing 2m Green	AC620GR
CORRAPOL®-BT Top Wall Flashing 2m Red	AC620RE
CORRAPOL®-BT Top Wall Flashing 3m Black	AC622BL
CORRAPOL®-BT Top Wall Flashing 3m Brown	AC622BR
CORRAPOL®-BT Top Wall Flashing 3m Green	AC622GR
CORRAPOL®-BT Top Wall Flashing 3m Red	AC622RE
CORRAPOL®-BT Top Wall Flashing 6m Black	AC628BL
CORRAPOL®-BT Top Wall Flashing 6m Brown	AC628BR
CORRAPOL®-BT Top Wall Flashing 6m Green	AC628GR
CORRAPOL®-BT Top Wall Flashing 6m Red	AC628RE

This part section illustration of the CORRAPOL®-BT Top Wall Flashing indicates how the flat angle verticle edge is fixed directly onto the wall and made waterproof by covering the angled side and fixings with lead flashing. The outer edges of the CORRAPOL®-BT Top Wall Flashing fits between the CORRAPOL®-BT Rock n' Lock Side and Wall Flashing. Sealant is added to the joining edges to give a waterproof finish.



## CORRAPOL®-BT : Budget Ridge

This CORRAPOL®-BT Budget Ridge provides a low cost Ridge Cover. Manufactured from the same bitumen product as the sheets, it provides a waterproof finish, but is not as robust or well-sealed as the CORRAPOL®-BT Super Ridge. Manufactured in four colours this CORRAPOL®-BT Budget Ridge is simply fixed with CORRAPOL®-BT Fixing Pins or CORRAPOL®-BT Flexible Screw Caps.

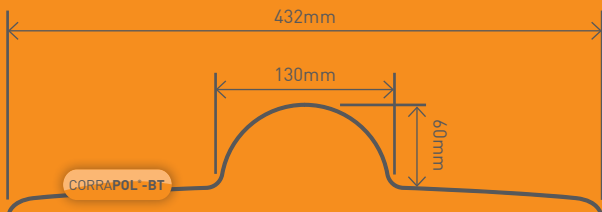

CORRAPOL-BT Corrugated Bitumen Roof Budget Ridge



Black



Red



Green



Brown

CORRAPOL®-BT: Ridge	Size	Code
BLACK Corrugated Bitumen Ridge	1000 mm	AC118BL
RED Corrugated Bitumen Ridge	1000 mm	AC118RD
GREEN Corrugated Bitumen Ridge	1000 mm	AC118GR
BROWN Corrugated Bitumen Ridge	1000 mm	AC118BR

## CORRAPOL®-BT : Foam Eaves Filler

CORRAPOL®-BT Foam Eaves Filler is manufactured from a flexible foam allowing successful sealing and draught proofing. The CORRAPOL®-BT Foam Eaves Filler is made with closed-cell foam so does not absorb moisture and can also be used to further improve waterproof sealing.

CORRAPOL®-BT: Eaves Filler	Quantity	Code
Corrugated Bitumen Foam Eaves Filler	4 pack	AC120



## CORRAPOL®-BT : Superior Flexible Fixings

The Superior CORRAPOL®-BT flexible fixings provide enhanced sealing to the contours of the curved peaks of the CORRAPOL®-BT sheets. Being a screw fixing they also enable the installer to control the fixing pressure, and allow removal of the fixings if needed. The concealed caps in any colour pervade and aesthetically pleasing finish to the fixing hiding the screw heads.

CORRAPOL®-BT: Screw Caps	Quantity	Code
BLACK 60mm Screw Cap Fixings – NEW	10 Pack	AC30BL
BLACK 60mm Screw Cap Fixings – NEW	50 Pack	AC32BL
RED 60mm Screw Cap Fixings – NEW	10 Pack	AC30RD
RED 60mm Screw Cap Fixings – NEW	50 Pack	AC32RD
GREEN 60mm Screw Cap Fixings – NEW	10 Pack	AC30GR
GREEN 60mm Screw Cap Fixings – NEW	50 Pack	AC32GR
BROWN 60mm Screw Cap Fixings – NEW	10 Pack	AC30BR
BROWN 60mm Screw Cap Fixings – NEW	50 Pack	AC32BR

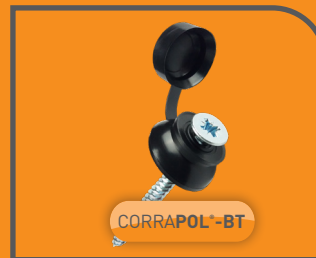

Black

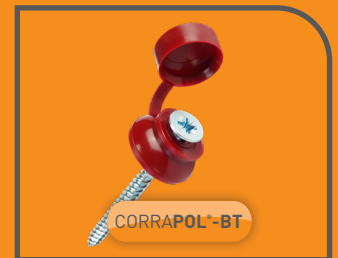

Red



Green

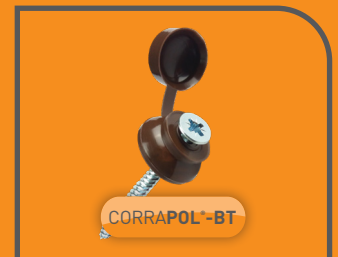

Brown

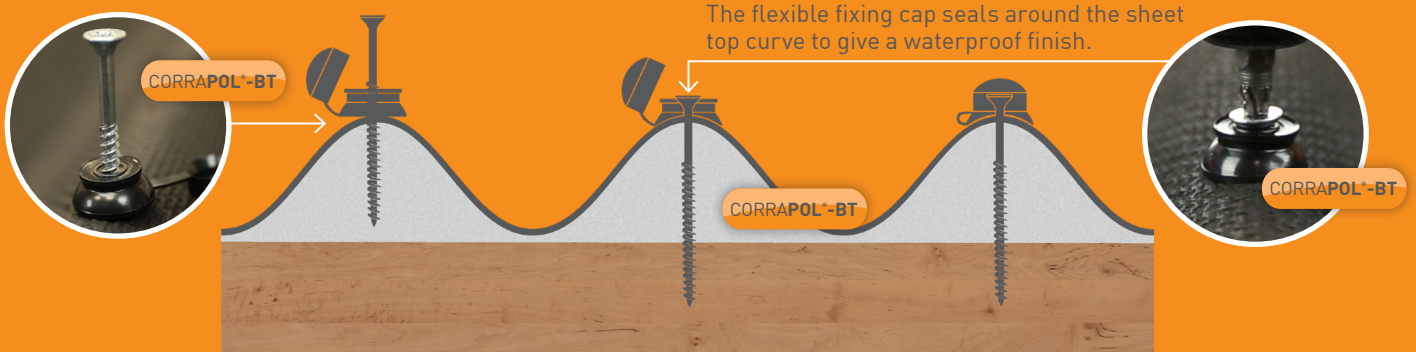

## CORRAPOL®-BT : Fixing Pins

These budget fixings are available in each of the four matching colours and provide a faster and simple fixing method.

CORRAPOL®-BT: Fixing Pins	Quantity	Code
BLACK Corrugated Bitumen Fixings	100 Pack	AC108BL
RED Corrugated Bitumen Fixings	100 Pack	AC108RD
GREEN Corrugated Bitumen Fixings	100 Pack	AC108GR
BROWN Corrugated Bitumen Fixings	100 Pack	AC108BR



Black



Red

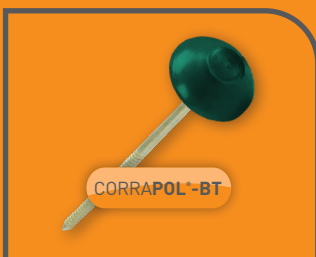

Green



Brown

# Other Ranges we Manufacture with Matching Corrugation

Please get in touch for more information about the many other products we manufacture.



## WARNING : REGISTERED DESIGNS & PATENTS

The IP of the designs in this brochure are protected by internationally registered design rights. Many products are also protected with active or pending Patents. Clear Amber will not hesitate to take appropriate legal action if its rights in this respect are infringed.

© Copyright – Clear Amber Group Ltd – May 2021. No part of this publication may be copied, reproduced, scanned, or stored in any electronic database, whether in whole or in part, in any form or by any means, without permission in writing from Clear Amber. Clear Amber will not hesitate to take appropriate legal action if its rights in this respect are infringed.

Inasmuch as Clear Amber have no control over the circumstances in which our material may be used, or site specific parameters, we cannot guarantee that any particular results will be achieved. Users should carry out their own tests to determine the suitability of the material for their application.