

## Uni 550

### UNI COLLECTION:

Uni 550, Uni 550M, Uni 378, Uni 378M, Uni 378B, Uni 378B-M, Uni 380, Uni 380M, Uni 380B, Uni 380B-M, Uni 562, Uni 562M, Uni 386, Uni 386M, Uni 602, Uni 602M, Uni 603, Uni 603M, Uni 551M, Uni 551, Uni 552, Uni 552M, Uni 552G, Uni 552M-G, Uni 552T, Uni 552G-T, Uni 558-DP, Uni 558M-DP, Uni 558-DR, Uni 558M-DR, Uni 553, Uni 553M, Uni 577, Uni 577M, Uni 544, Uni 565, Uni 391, Uni 391M, Uni 393, Uni 393M, Uni 220, Uni 221, Uni 222, Uni 223, Trolley 536,

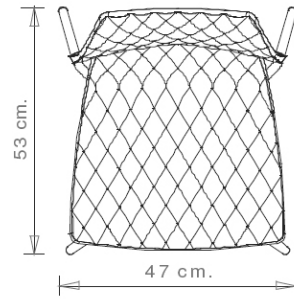
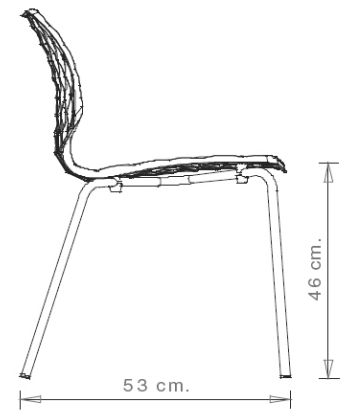
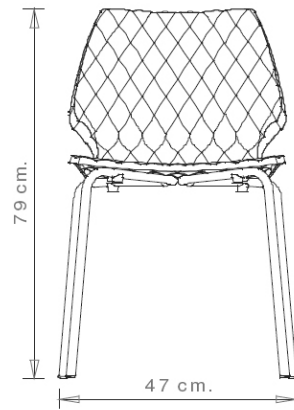

Chair with steel frame, 4 legs. Polypropylene shell.

#### STACKABLE

8

#### WEIGHT

4,6 kg

#### PACK

0,36 m<sup>3</sup>

#### PIECES PER BOX

5

## FINISHES SEATING

### PP POLYPROPYLENE



RAL 9016 Traffic white



NCS S2060-B Azure



RAL 3000 Flame red



RAL 7016 Anthracite  
grey



RAL 2003 Pastel  
orange

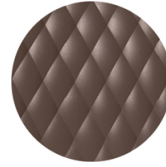

NCS S7005-Y50R  
Cocoa



RAL 9005 Jet black



RAL 4008 Signal violet



PANTONE 380 C  
Boss green



NCS S4005-Y50R  
Turtle-dove



RAL 1004 Golden  
yellow



PANTONE 18-1438  
Marsala

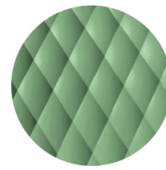

RAL 6021 Pale green

## FRAMES

### AC STEEL



RAL 9016  
VR Traffic white



RAL 9010  
VR Pure white

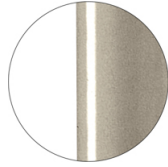

PANTONE 402 C  
VR Turtle-dove

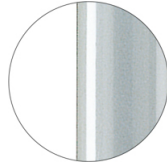

RAL 9006  
VR White aluminium

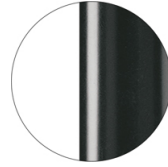

RAL 7016  
VR Anthracite grey

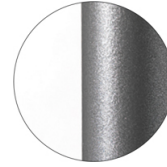

VR Pewter

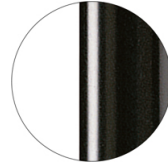

RAL 9005  
VR Jet black

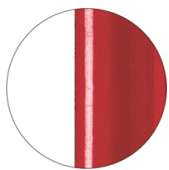

RAL 3003  
VR Ruby red

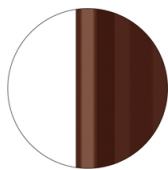

RAL 8017  
VR Chocolate brown

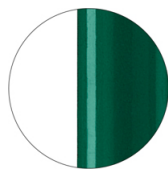

RAL 6005  
VR Moss green

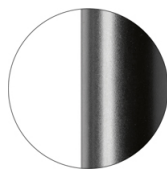

RAL 9005  
VR Matt Jet Black

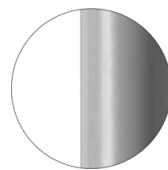

RAL 7037  
VR Matt Dusty grey

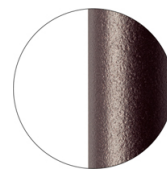

VR Rough metallic  
bronze



CR Chrome

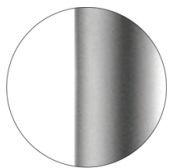

CR S Satin chrome



CR X Brass chrome

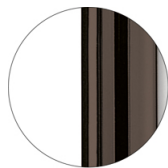

CR X Burnished chrome

## CERTIFICATIONS

- > UNI/EN 15373:2007 - Test 1. Carico statico sedile e schienale: 3 (23/01/13)
- > UNI/EN 15373:2007 - Test 10. Prova di fatica sedile e schienale: 3 (27/06/11)
- > UNI/EN 15373:2007 - Test 19. Prova d'urto sul sedile: 3 (27/06/11)

## USES

coffee & restaurants, office and waiting areas, outdoor,

## Uni 550M

### UNI COLLECTION:

Uni 550, Uni 550M, Uni 378, Uni 378M, Uni 378B, Uni 378B-M, Uni 380, Uni 380M, Uni 380B, Uni 380B-M, Uni 562, Uni 562M, Uni 386, Uni 386M, Uni 602, Uni 602M, Uni 603, Uni 603M, Uni 551M, Uni 551, Uni 552, Uni 552M, Uni 552G, Uni 552M-G, Uni 552T, Uni 552G-T, Uni 558-DP, Uni 558M-DP, Uni 558-DR, Uni 558M-DR, Uni 553, Uni 553M, Uni 577, Uni 577M, Uni 544, Uni 565, Uni 391, Uni 391M, Uni 393, Uni 393M, Uni 220, Uni 221, Uni 222, Uni 223, Trolley 536,

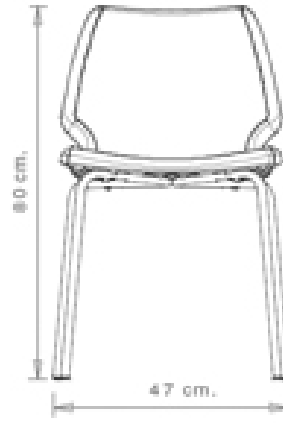

Chair with steel frame, 4 legs. Upholstered polypropylene shell.

#### WEIGHT

6,75 kg

#### PACK

0,24 m<sup>3</sup>

#### PIECES PER BOX

1

## FINISHES SEATING

### TE FABRICS



Citadel Camira  
+ 16 colours



Medley Gabriel  
+ 14 colours



Inca Abitex  
+ 15 colours



Crazy Flukso  
+ 7 colours



Xtreme Camira  
+ 16 colours

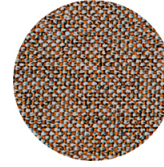

Rivet Camira  
+ 12 colours



Valencia Spradling  
+ 17 colours

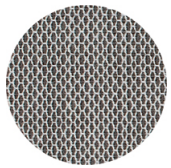

Criss Cross Gabriel  
+ 19 colours

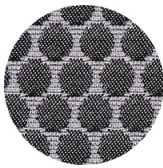

Bubble Flukso  
+ 9 colours



Europost 2 Gabriel  
+ 16 colours



Fame Gabriel  
+ 23 colours



Parotega NF  
Skai Hornschuh  
+ 8 colours

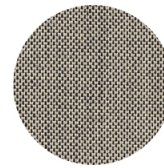

Balta Vescom  
+ 12 colours

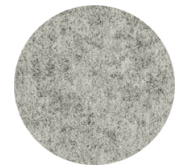

Blazer Camira  
+ 25 colours

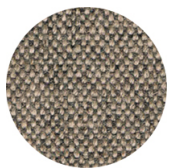

Main line flax Camira  
+ 13 colours

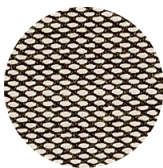

Steelcut trio 3  
Kvadrat  
+ 20 colours

### PP POLYPROPYLENE



RAL 9016 Traffic white

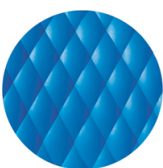

NCS S2060-B Azure



RAL 3000 Flame red



RAL 7016 Anthracite  
grey



RAL 2003 Pastel  
orange

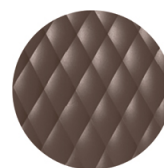

NCS S7005-Y50R  
Cocoa



RAL 9005 Jet black



RAL 4008 Signal violet



PANTONE 380 C  
Boss green



NCS S4005-Y50R  
Turtle-dove



RAL 1004 Golden  
yellow



PANTONE 18-1438  
Marsala

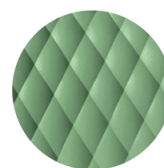

RAL 6021 Pale green

## FRAMES

### AC STEEL



RAL 9016  
VR Traffic white



RAL 9010  
VR Pure white

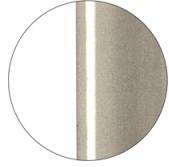

PANTONE 402 C  
VR Turtle-dove

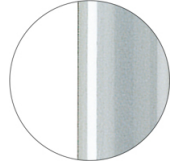

RAL 9006  
VR White aluminium

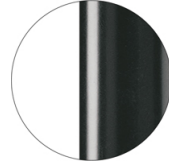

RAL 7016  
VR Anthracite grey

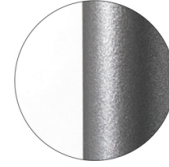

VR Pewter

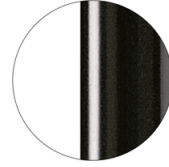

RAL 9005  
VR Jet black

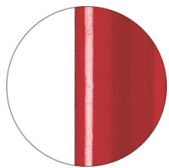

RAL 3003  
VR Ruby red

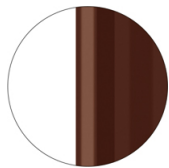

RAL 8017  
VR Chocolate brown

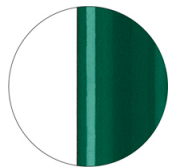

RAL 6005  
VR Moss green

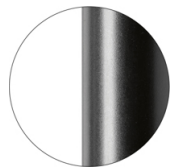

RAL 9005  
VR Matt Jet Black

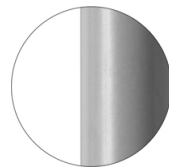

RAL 7037  
VR Matt Dusty grey

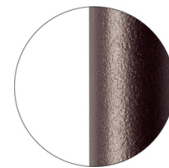

VR Rough metallic  
bronze



CR Chrome

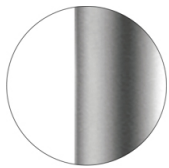

CR S Satin chrome



CR X Brass chrome

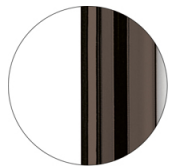

CR X Burnished chrome

## CERTIFICATIONS

> UNI/EN 16139:2013 - Par.6. Prova 8. Prova di fatica sedile e schienale: 2-Usò estremo (03/07/16)

## USES

coffee & restaurants, office and waiting areas, outdoor,

## Uni 378

### UNI COLLECTION:

Uni 550, Uni 550M, Uni 378, Uni 378M, Uni 378B, Uni 378B-M, Uni 380, Uni 380M, Uni 380B, Uni 380B-M, Uni 562, Uni 562M, Uni 386, Uni 386M, Uni 602, Uni 602M, Uni 603, Uni 603M, Uni 551M, Uni 551, Uni 552, Uni 552M, Uni 552G, Uni 552M-G, Uni 552T, Uni 552G-T, Uni 558-DP, Uni 558M-DP, Uni 558-DR, Uni 558M-DR, Uni 553, Uni 553M, Uni 577, Uni 577M, Uni 544, Uni 565, Uni 391, Uni 391M, Uni 393, Uni 393M, Uni 220, Uni 221, Uni 222, Uni 223, Trolley 536,



Barstool with steel frame, 4 legs. Polypropylene seat.

**STACKABLE**

4

**WEIGHT**

6,8 kg

**PACK**

0,46 m<sup>3</sup>

**PIECES PER BOX**

4

## FINISHES SEATING

### PP POLYPROPYLENE



RAL 9016 Traffic white



NCS S2060-B Azure



RAL 3000 Flame red



RAL 7016 Anthracite  
grey



RAL 2003 Pastel  
orange

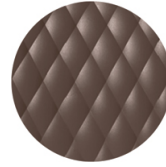

NCS S7005-Y50R  
Cocoa



RAL 9005 Jet black



RAL 4008 Signal violet



PANTONE 380 C  
Boss green



NCS S4005-Y50R  
Turtle-dove



RAL 1004 Golden  
yellow



PANTONE 18-1438  
Marsala

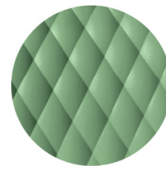

RAL 6021 Pale green



## FRAMES

### AC STEEL



RAL 9016  
VR Traffic white



RAL 9010  
VR Pure white

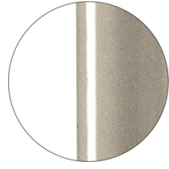

PANTONE 402 C  
VR Turtle-dove

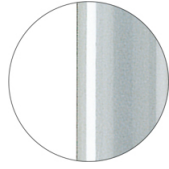

RAL 9006  
VR White aluminium

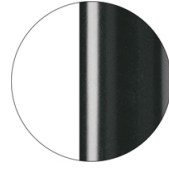

RAL 7016  
VR Anthracite grey

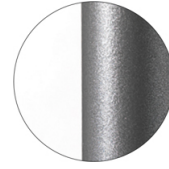

VR Pewter

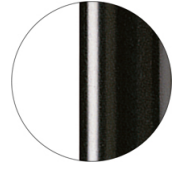

RAL 9005  
VR Jet black

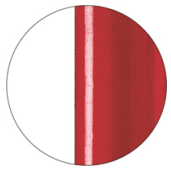

RAL 3003  
VR Ruby red



RAL 8017  
VR Chocolate brown

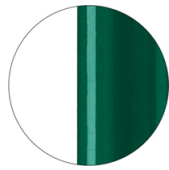

RAL 6005  
VR Moss green

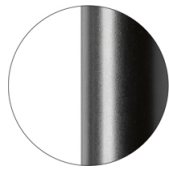

RAL 9005  
VR Matt Jet Black

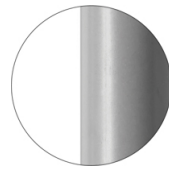

RAL 7037  
VR Matt Dusty grey

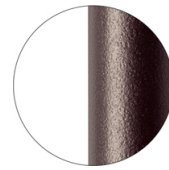

VR Rough metallic  
bronze



CR Chrome

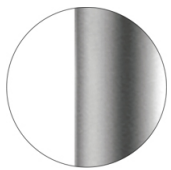

CR S Satin chrome



CR X Brass chrome

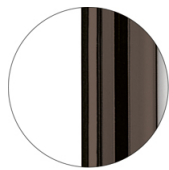

CR X Burnished chrome

## USES

coffee & restaurants, office and waiting areas, outdoor,

## Uni 378M



### UNI COLLECTION:

Uni 550, Uni 550M, Uni 378, Uni 378M, Uni 378B, Uni 378B-M, Uni 380, Uni 380M, Uni 380B, Uni 380B-M, Uni 562, Uni 562M, Uni 386, Uni 386M, Uni 602, Uni 602M, Uni 603, Uni 603M, Uni 551M, Uni 551, Uni 552, Uni 552M, Uni 552G, Uni 552M-G, Uni 552T, Uni 552G-T, Uni 558-DP, Uni 558M-DP, Uni 558-DR, Uni 558M-DR, Uni 553, Uni 553M, Uni 577, Uni 577M, Uni 544, Uni 565, Uni 391, Uni 391M, Uni 393, Uni 393M, Uni 220, Uni 221, Uni 222, Uni 223, Trolley 536,



Barstool with steel frame, 4 legs. Upholstered polypropylene seat.

**WEIGHT**

8,95Kg

**PACK**0,46 m<sup>3</sup>**PIECES PER BOX**

1

## FINISHES SEATING

### TE FABRICS



Citadel Camira  
+ 16 colours



Medley Gabriel  
+ 14 colours



Inca Abitex  
+ 15 colours



Crazy Flukso  
+ 7 colours



Xtreme Camira  
+ 16 colours

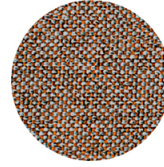

Rivet Camira  
+ 12 colours



Valencia Spradling  
+ 17 colours

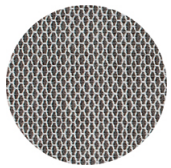

Criss Cross Gabriel  
+ 19 colours

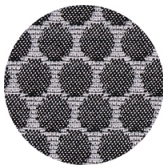

Bubble Flukso  
+ 9 colours



Europost 2 Gabriel  
+ 16 colours



Fame Gabriel  
+ 23 colours



Parotega NF  
Skai Hornschuh  
+ 8 colours

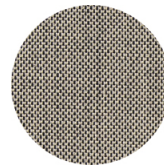

Balta Vescom  
+ 12 colours

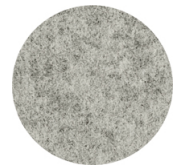

Blazer Camira  
+ 25 colours

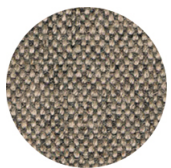

Main line flax Camira  
+ 13 colours

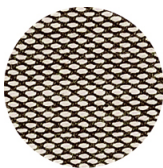

Steelcut trio 3  
Kvadrat  
+ 20 colours

### PP POLYPROPYLENE



RAL 9016 Traffic white

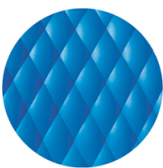

NCS S2060-B Azure



RAL 3000 Flame red



RAL 7016 Anthracite  
grey



RAL 2003 Pastel  
orange

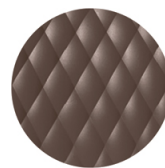

NCS S7005-Y50R  
Cocoa



RAL 9005 Jet black



RAL 4008 Signal violet



PANTONE 380 C  
Boss green



NCS S4005-Y50R  
Turtle-dove



RAL 1004 Golden  
yellow



PANTONE 18-1438  
Marsala

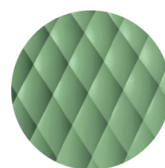

RAL 6021 Pale green

## FRAMES

### AC STEEL



RAL 9016  
VR Traffic white



RAL 9010  
VR Pure white

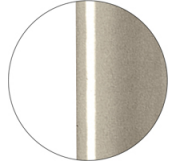

PANTONE 402 C  
VR Turtle-dove

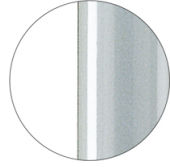

RAL 9006  
VR White aluminium

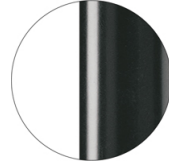

RAL 7016  
VR Anthracite grey

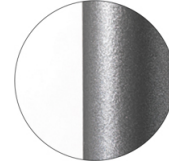

VR Pewter

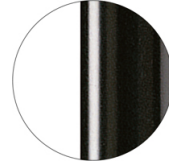

RAL 9005  
VR Jet black

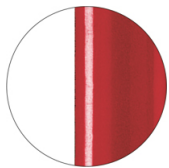

RAL 3003  
VR Ruby red

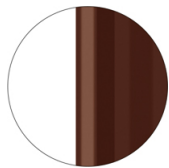

RAL 8017  
VR Chocolate brown

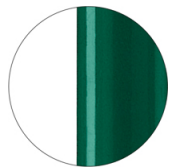

RAL 6005  
VR Moss green

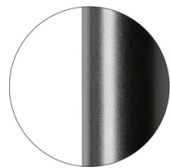

RAL 9005  
VR Matt Jet Black

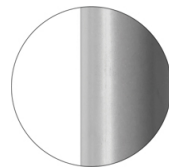

RAL 7037  
VR Matt Dusty grey

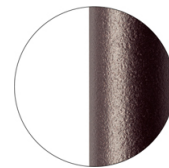

VR Rough metallic  
bronze



CR Chrome

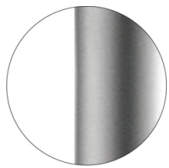

CR S Satin chrome



CR X Brass chrome



CR X Burnished chrome

## USES

coffee & restaurants, office and waiting areas, outdoor,

## Uni 378B



### UNI COLLECTION:

Uni 550, Uni 550M, Uni 378, Uni 378M, Uni 378B, Uni 378B-M, Uni 380, Uni 380M, Uni 380B, Uni 380B-M, Uni 562, Uni 562M, Uni 386, Uni 386M, Uni 602, Uni 602M, Uni 603, Uni 603M, Uni 551M, Uni 551, Uni 552, Uni 552M, Uni 552G, Uni 552M-G, Uni 552T, Uni 552G-T, Uni 558-DP, Uni 558M-DP, Uni 558-DR, Uni 558M-DR, Uni 553, Uni 553M, Uni 577, Uni 577M, Uni 544, Uni 565, Uni 391, Uni 391M, Uni 393, Uni 393M, Uni 220, Uni 221, Uni 222, Uni 223, Trolley 536,



Barstool with steel frame, 4 legs. Polypropylene seat. Version with seat-height H 65 cm.

**STACKABLE**

4

**WEIGHT**

6,5 Kg

**PACK**0,37 m<sup>3</sup>**PIECES PER BOX**

4

## FINISHES SEATING

### PP POLYPROPYLENE



RAL 9016 Traffic white



NCS S2060-B Azure



RAL 3000 Flame red



RAL 7016 Anthracite  
grey



RAL 2003 Pastel  
orange

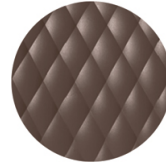

NCS S7005-Y50R  
Cocoa



RAL 9005 Jet black



RAL 4008 Signal violet



PANTONE 380 C  
Boss green



NCS S4005-Y50R  
Turtle-dove



RAL 1004 Golden  
yellow



PANTONE 18-1438  
Marsala

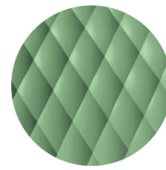

RAL 6021 Pale green

## FRAMES

### AC STEEL



RAL 9016  
VR Traffic white



RAL 9010  
VR Pure white

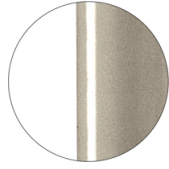

PANTONE 402 C  
VR Turtle-dove

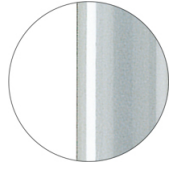

RAL 9006  
VR White aluminium

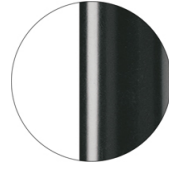

RAL 7016  
VR Anthracite grey

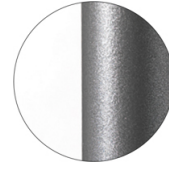

VR Pewter

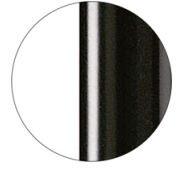

RAL 9005  
VR Jet black

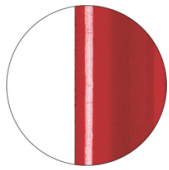

RAL 3003  
VR Ruby red



RAL 8017  
VR Chocolate brown

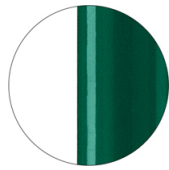

RAL 6005  
VR Moss green

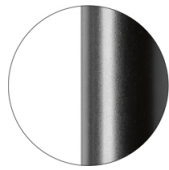

RAL 9005  
VR Matt Jet Black

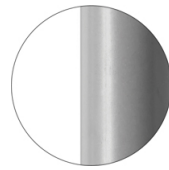

RAL 7037  
VR Matt Dusty grey

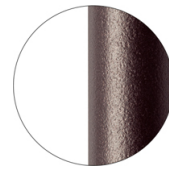

VR Rough metallic  
bronze



CR Chrome

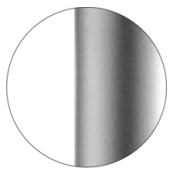

CR S Satin chrome



CR X Brass chrome

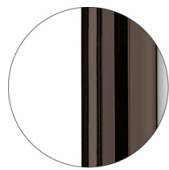

CR X Burnished chrome

## USES

coffee & restaurants, office and waiting areas, outdoor,

## Uni 378B-M



### UNI COLLECTION:

Uni 550, Uni 550M, Uni 378, Uni 378M, Uni 378B, Uni 378B-M, Uni 380, Uni 380M, Uni 380B, Uni 380B-M, Uni 562, Uni 562M, Uni 386, Uni 386M, Uni 602, Uni 602M, Uni 603, Uni 603M, Uni 551M, Uni 551, Uni 552, Uni 552M, Uni 552G, Uni 552M-G, Uni 552T, Uni 552G-T, Uni 558-DP, Uni 558M-DP, Uni 558-DR, Uni 558M-DR, Uni 553, Uni 553M, Uni 577, Uni 577M, Uni 544, Uni 565, Uni 391, Uni 391M, Uni 393, Uni 393M, Uni 220, Uni 221, Uni 222, Uni 223, Trolley 536,



Barstool with steel frame, 4 legs. Upholstered polypropylene seat.  
Version with seat-height H 66 cm.

**WEIGHT**

8,6 kg

**PACK**0,37 m<sup>3</sup>**PIECES PER BOX**

1



## FINISHES SEATING

### TE FABRICS



Citadel Camira  
+ 16 colours



Medley Gabriel  
+ 14 colours



Inca Abitex  
+ 15 colours



Crazy Flukso  
+ 7 colours



Xtreme Camira  
+ 16 colours

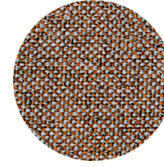

Rivet Camira  
+ 12 colours



Valencia Spradling  
+ 17 colours

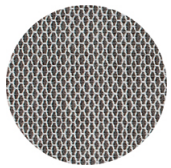

Criss Cross Gabriel  
+ 19 colours

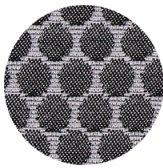

Bubble Flukso  
+ 9 colours



Europost 2 Gabriel  
+ 16 colours



Fame Gabriel  
+ 23 colours



Parotega NF  
Skai Hornschuch  
+ 8 colours

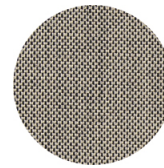

Balta Vescom  
+ 12 colours

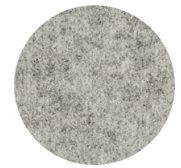

Blazer Camira  
+ 25 colours

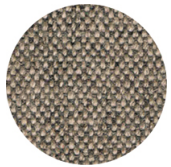

Main line flax Camira  
+ 13 colours

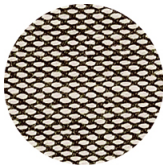

Steelcut trio 3  
Kvadrat  
+ 20 colours

### PP POLYPROPYLENE



RAL 9016 Traffic  
white

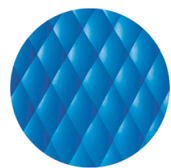

NCS S2060-B Azure



RAL 3000 Flame red



RAL 7016 Anthracite  
grey



RAL 2003 Pastel  
orange

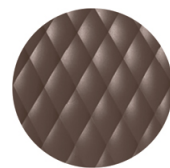

NCS S7005-Y50R  
Cocoa



RAL 9005 Jet black



PANTONE 380 C  
Boss green



NCS S4005-Y50R  
Turtle-dove



RAL 1004 Golden  
yellow



PANTONE 18-1438  
Marsala

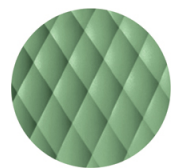

RAL 6021 Pale green

## FRAMES

### AC STEEL



RAL 9016  
VR Traffic white



RAL 9010  
VR Pure white

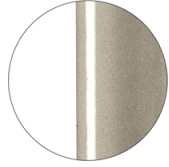

PANTONE 402 C  
VR Turtle-dove

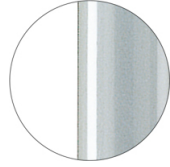

RAL 9006  
VR White aluminium

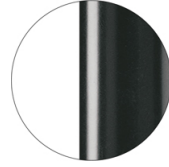

RAL 7016  
VR Anthracite grey

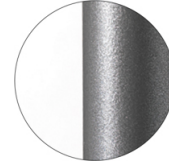

VR Pewter

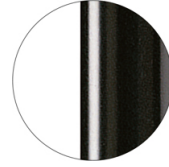

RAL 9005  
VR Jet black

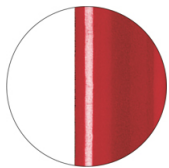

RAL 3003  
VR Ruby red

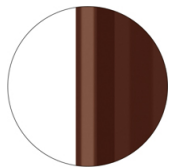

RAL 8017  
VR Chocolate brown

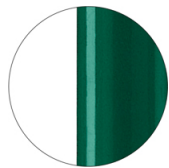

RAL 6005  
VR Moss green

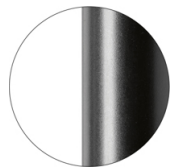

RAL 9005  
VR Matt Jet Black

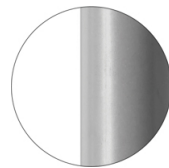

RAL 7037  
VR Matt Dusty grey

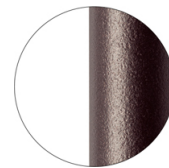

VR Rough metallic  
bronze



CR Chrome

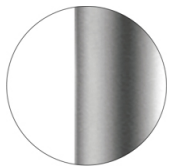

CR S Satin chrome



CR X Brass chrome

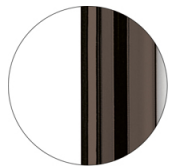

CR X Burnished chrome

## USES

coffee & restaurants, office and waiting areas, outdoor,

## Uni 380

### UNI COLLECTION:

Uni 550, Uni 550M, Uni 378, Uni 378M, Uni 378B, Uni 378B-M, Uni 380, Uni 380M, Uni 380B, Uni 380B-M, Uni 562, Uni 562M, Uni 386, Uni 386M, Uni 602, Uni 602M, Uni 603, Uni 603M, Uni 551M, Uni 551, Uni 552, Uni 552M, Uni 552G, Uni 552M-G, Uni 552T, Uni 552G-T, Uni 558-DP, Uni 558M-DP, Uni 558-DR, Uni 558M-DR, Uni 553, Uni 553M, Uni 577, Uni 577M, Uni 544, Uni 565, Uni 391, Uni 391M, Uni 393, Uni 393M, Uni 220, Uni 221, Uni 222, Uni 223, Trolley 536,

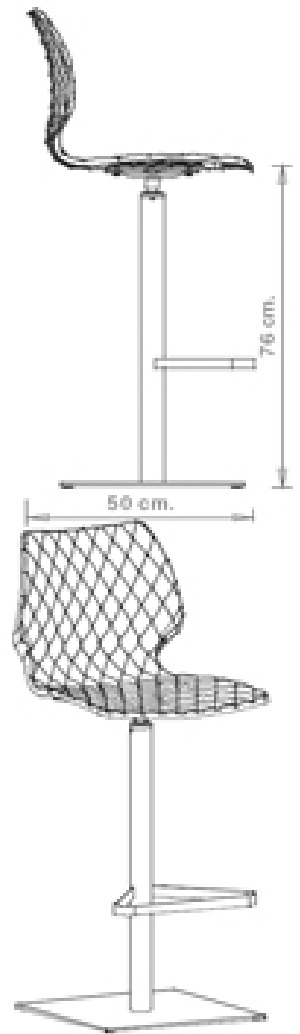
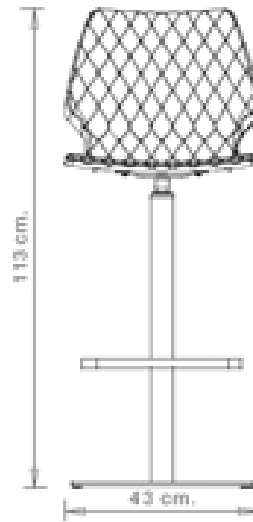

Swivel barstool with central steel base and kick-back device. Polypropylene seat.

#### WEIGHT

17 kg

#### PACK

0,29 m<sup>3</sup>

#### PIECES PER BOX

1

## FINISHES SEATING

### PP POLYPROPYLENE



RAL 9016 Traffic white

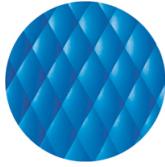

NCS S2060-B Azure



RAL 3000 Flame red



RAL 7016 Anthracite grey



RAL 2003 Pastel orange

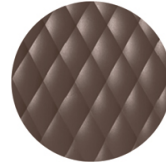

NCS S7005-Y50R Cocoa



RAL 9005 Jet black



RAL 4008 Signal violet



PANTONE 380 C Boss green

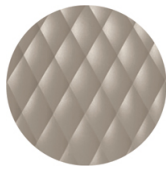

NCS S4005-Y50R Turtle-dove



RAL 1004 Golden yellow



PANTONE 18-1438 Marsala

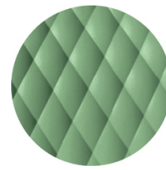

RAL 6021 Pale green

## FRAMES

### AC STEEL



RAL 9016 VR Traffic white



RAL 9010 VR Pure white

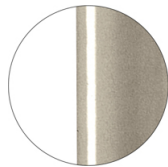

PANTONE 402 C VR Turtle-dove

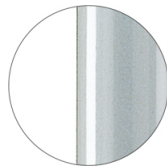

RAL 9006 VR White aluminium

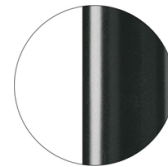

RAL 7016 VR Anthracite grey

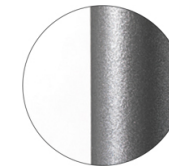

VR Pewter

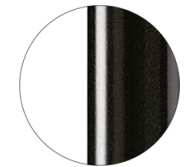

RAL 9005 VR Jet black

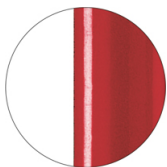

RAL 3003 VR Ruby red

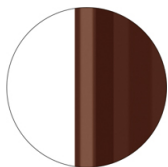

RAL 8017 VR Chocolate brown

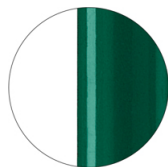

RAL 6005 VR Moss green

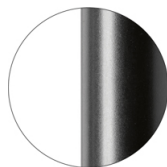

RAL 9005 VR Matt Jet Black

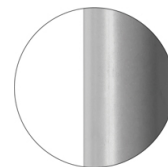

RAL 7037 VR Matt Dusty grey

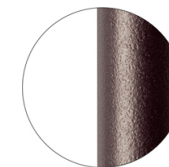

VR Rough metallic bronze



CR Chrome

## USES

coffee & restaurants, office and waiting areas, outdoor,

## Uni 380M



### UNI COLLECTION:

Uni 550, Uni 550M, Uni 378, Uni 378M, Uni 378B, Uni 378B-M, Uni 380, Uni 380M, Uni 380B, Uni 380B-M, Uni 562, Uni 562M, Uni 386, Uni 386M, Uni 602, Uni 602M, Uni 603, Uni 603M, Uni 551M, Uni 551, Uni 552, Uni 552M, Uni 552G, Uni 552M-G, Uni 552T, Uni 552G-T, Uni 558-DP, Uni 558M-DP, Uni 558-DR, Uni 558M-DR, Uni 553, Uni 553M, Uni 577, Uni 577M, Uni 544, Uni 565, Uni 391, Uni 391M, Uni 393, Uni 393M, Uni 220, Uni 221, Uni 222, Uni 223, Trolley 536,



Swivel barstool with central steel base and kick-back device. Upholstered polypropylene seat.

**WEIGHT**

19,2Kg

**PACK**0,29 m<sup>3</sup>**PIECES PER BOX**

1

## FINISHES SEATING

### TE FABRICS



Citadel Camira  
+ 16 colours



Medley Gabriel  
+ 14 colours



Inca Abitex  
+ 15 colours



Crazy Flukso  
+ 7 colours



Xtreme Camira  
+ 16 colours

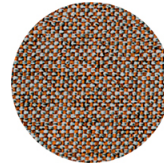

Rivet Camira  
+ 12 colours



Valencia Spradling  
+ 17 colours

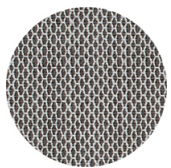

Criss Cross Gabriel  
+ 19 colours

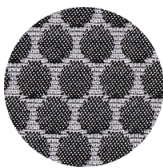

Bubble Flukso  
+ 9 colours



Europost 2 Gabriel  
+ 16 colours



Fame Gabriel  
+ 23 colours



Parotega NF  
Skai Hornschuh  
+ 8 colours

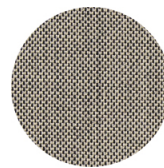

Balta Vescom  
+ 12 colours



Blazer Camira  
+ 25 colours

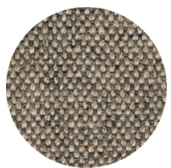

Main line flax Camira  
+ 13 colours

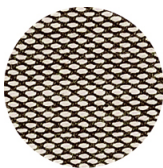

Steelcut trio 3  
Kvadrat  
+ 20 colours

### PP POLYPROPYLENE



RAL 9016 Traffic white

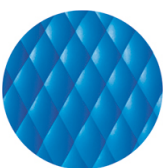

NCS S2060-B Azure



RAL 3000 Flame red



RAL 7016 Anthracite  
grey



RAL 2003 Pastel  
orange

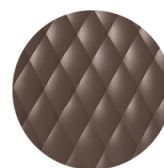

NCS S7005-Y50R  
Cocoa



RAL 9005 Jet black



RAL 4008 Signal violet



PANTONE 380 C  
Boss green

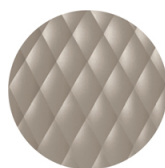

NCS S4005-Y50R  
Turtle-dove



RAL 1004 Golden  
yellow



PANTONE 18-1438  
Marsala

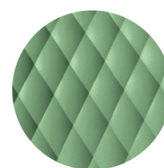

RAL 6021 Pale green

## FRAMES

### AC STEEL



RAL 9016  
VR Traffic white



RAL 9010  
VR Pure white

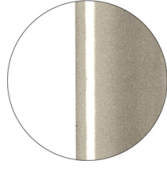

PANTONE 402 C  
VR Turtle-dove

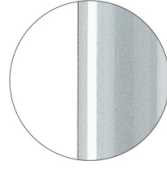

RAL 9006  
VR White aluminium

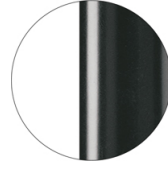

RAL 7016  
VR Anthracite grey

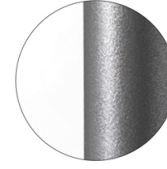

VR Pewter

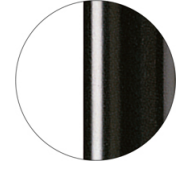

RAL 9005  
VR Jet black

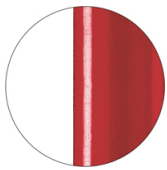

RAL 3003  
VR Ruby red

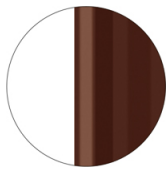

RAL 8017  
VR Chocolate brown

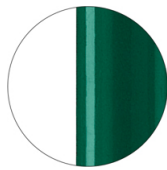

RAL 6005  
VR Moss green

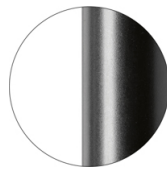

RAL 9005  
VR Matt Jet Black

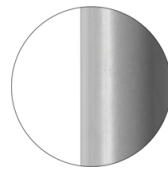

RAL 7037  
VR Matt Dusty grey

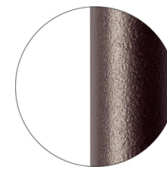

VR Rough metallic  
bronze



CR Chrome

## USES

coffee & restaurants, office and waiting areas, outdoor,

## Uni 380B



### UNI COLLECTION:

Uni 550, Uni 550M, Uni 378, Uni 378M, Uni 378B, Uni 378B-M, Uni 380, Uni 380M, Uni 380B, Uni 380B-M, Uni 562, Uni 562M, Uni 386, Uni 386M, Uni 602, Uni 602M, Uni 603, Uni 603M, Uni 551M, Uni 551, Uni 552, Uni 552M, Uni 552G, Uni 552M-G, Uni 552T, Uni 552G-T, Uni 558-DP, Uni 558M-DP, Uni 558-DR, Uni 558M-DR, Uni 553, Uni 553M, Uni 577, Uni 577M, Uni 544, Uni 565, Uni 391, Uni 391M, Uni 393, Uni 393M, Uni 220, Uni 221, Uni 222, Uni 223, Trolley 536,



Swivel barstool with central steel base and kick-back device. Polypropylene seat. Version seatheight H 65 cm.

**WEIGHT**

16,7 Kg

**PACK**0,29 m<sup>3</sup>**PIECES PER BOX**

1



## FINISHES SEATING

### PP POLYPROPYLENE



RAL 9016 Traffic white

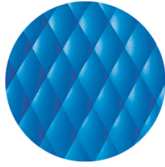

NCS S2060-B Azure



RAL 3000 Flame red



RAL 7016 Anthracite grey



RAL 2003 Pastel orange

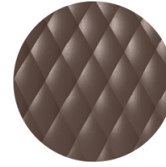

NCS S7005-Y50R Cocoa



RAL 9005 Jet black



RAL 4008 Signal violet



PANTONE 380 C Boss green



NCS S4005-Y50R Turtle-dove



RAL 1004 Golden yellow

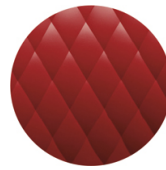

PANTONE 18-1438 Marsala

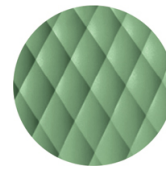

RAL 6021 Pale green

## FRAMES

### AC STEEL



RAL 9016 VR Traffic white



RAL 9010 VR Pure white

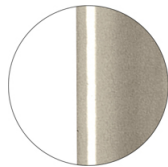

PANTONE 402 C VR Turtle-dove

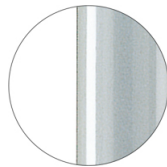

RAL 9006 VR White aluminium

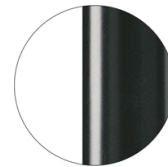

RAL 7016 VR Anthracite grey

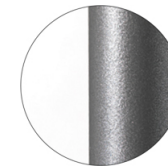

VR Pewter

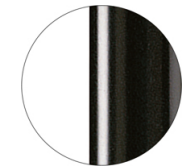

RAL 9005 VR Jet black

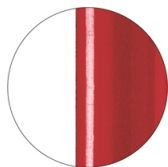

RAL 3003 VR Ruby red

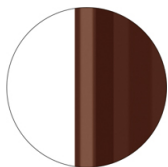

RAL 8017 VR Chocolate brown

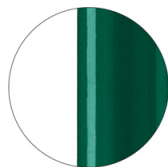

RAL 6005 VR Moss green

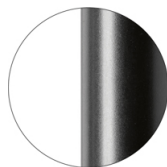

RAL 9005 VR Matt Jet Black

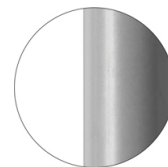

RAL 7037 VR Matt Dusty grey

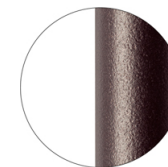

VR Rough metallic bronze



CR Chrome

## USES

coffee & restaurants, office and waiting areas, outdoor,

## Uni 380B-M



### UNI COLLECTION:

Uni 550, Uni 550M, Uni 378, Uni 378M, Uni 378B, Uni 378B-M, Uni 380, Uni 380M, Uni 380B, Uni 380B-M, Uni 562, Uni 562M, Uni 386, Uni 386M, Uni 602, Uni 602M, Uni 603, Uni 603M, Uni 551M, Uni 551, Uni 552, Uni 552M, Uni 552G, Uni 552M-G, Uni 552T, Uni 552G-T, Uni 558-DP, Uni 558M-DP, Uni 558-DR, Uni 558M-DR, Uni 553, Uni 553M, Uni 577, Uni 577M, Uni 544, Uni 565, Uni 391, Uni 391M, Uni 393, Uni 393M, Uni 220, Uni 221, Uni 222, Uni 223, Trolley 536,



Swivel barstool with central steel base and kick-back device. Upholstered polypropylene seat.  
Version seatheight H 66 cm..

**WEIGHT**

18,85 kg

**PACK**0,27 m<sup>3</sup>**PIECES PER BOX**

1

## FINISHES SEATING

### TE FABRICS



Citadel Camira  
+ 16 colours



Medley Gabriel  
+ 14 colours



Inca Abitex  
+ 15 colours



Crazy Flukso  
+ 7 colours



Xtreme Camira  
+ 16 colours

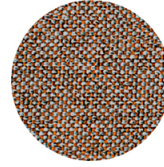

Rivet Camira  
+ 12 colours



Valencia Spradling  
+ 17 colours

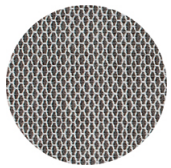

Criss Cross Gabriel  
+ 19 colours

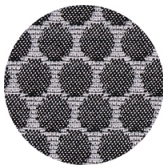

Bubble Flukso  
+ 9 colours



Europost 2 Gabriel  
+ 16 colours



Fame Gabriel  
+ 23 colours



Parotega NF  
Skai Hornschuh  
+ 8 colours

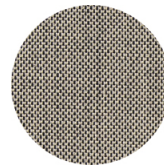

Balta Vescom  
+ 12 colours

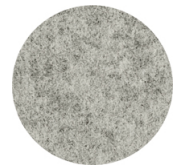

Blazer Camira  
+ 25 colours

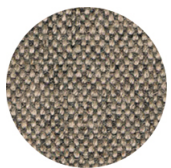

Main line flax Camira  
+ 13 colours

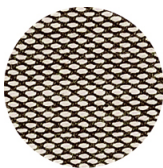

Steelcut trio 3  
Kvadrat  
+ 20 colours

### PP POLYPROPYLENE



RAL 9016 Traffic white

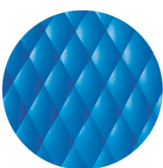

NCS S2060-B Azure



RAL 3000 Flame red



RAL 7016 Anthracite  
grey



RAL 2003 Pastel  
orange



NCS S7005-Y50R  
Cocoa



RAL 9005 Jet black



RAL 4008 Signal violet



PANTONE 380 C  
Boss green



NCS S4005-Y50R  
Turtle-dove



RAL 1004 Golden  
yellow



PANTONE 18-1438  
Marsala

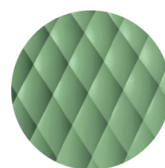

RAL 6021 Pale green

## FRAMES

### AC STEEL



RAL 9016  
VR Traffic white



RAL 9010  
VR Pure white

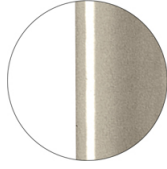

PANTONE 402 C  
VR Turtle-dove

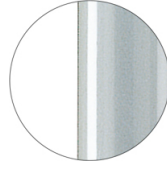

RAL 9006  
VR White aluminium

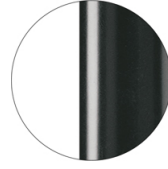

RAL 7016  
VR Anthracite grey

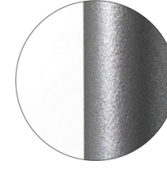

VR Pewter

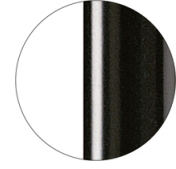

RAL 9005  
VR Jet black

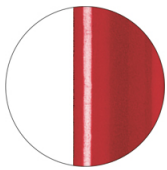

RAL 3003  
VR Ruby red



RAL 8017  
VR Chocolate brown



RAL 6005  
VR Moss green

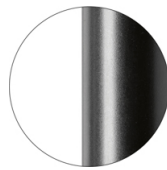

RAL 9005  
VR Matt Jet Black

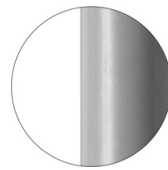

RAL 7037  
VR Matt Dusty grey

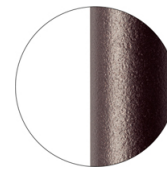

VR Rough metallic  
bronze



CR Chrome

## USES

coffee & restaurants, office and waiting areas, outdoor,

## Uni 562

### UNI COLLECTION:

Uni 550, Uni 550M, Uni 378, Uni 378M, Uni 378B, Uni 378B-M, Uni 380, Uni 380M, Uni 380B, Uni 380B-M, Uni 562, Uni 562M, Uni 386, Uni 386M, Uni 602, Uni 602M, Uni 603, Uni 603M, Uni 551M, Uni 551, Uni 552, Uni 552M, Uni 552G, Uni 552M-G, Uni 552T, Uni 552G-T, Uni 558-DP, Uni 558M-DP, Uni 558-DR, Uni 558M-DR, Uni 553, Uni 553M, Uni 577, Uni 577M, Uni 544, Uni 565, Uni 391, Uni 391M, Uni 393, Uni 393M, Uni 220, Uni 221, Uni 222, Uni 223, Trolley 536,



Chair with beech wood frame, 4 legs. Polypropylene shell.

#### WEIGHT

4,5 kg

#### PACK

0,29 m<sup>3</sup>

#### PIECES PER BOX

2

## FINISHES SEATING

### PP POLYPROPYLENE



RAL 9016 Traffic white

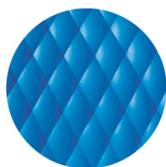

NCS S2060-B Azure



RAL 3000 Flame red



RAL 7016 Anthracite  
grey



RAL 2003 Pastel  
orange

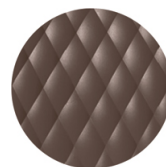

NCS S7005-Y50R  
Cocoa



RAL 9005 Jet black



RAL 4008 Signal violet



PANTONE 380 C  
Boss green



NCS S4005-Y50R  
Turtle-dove



RAL 1004 Golden  
yellow



PANTONE 18-1438  
Marsala

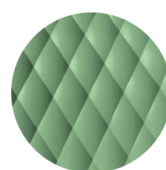

RAL 6021 Pale green

## FRAMES

### LE WOOD



Maple stained beech  
wood



Natural beech wood



Wengé stained beech  
wood



Black stained beech  
wood



"Canaletto" walnut  
stained beech wood



Oak stained beech  
wood

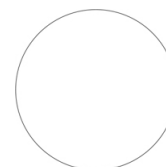

Stained according to  
sample

## CERTIFICATIONS

- > UNI/EN 16139:2013 - Prova 12. Carico statico gambe anteriori: 2-Uso estremo (07/06/13)
- > UNI/EN 16139:2013 - Prova 13. Carico statico gambe laterali: 2-Uso estremo (07/06/13)
- > UNI/EN 16139:2013 - Prova 8. Prova di fatica sedile e schienale: 2-Uso estremo (13/09/16)

## USES

coffee & restaurants, office and waiting areas, outdoor,

## Uni 562M



### UNI COLLECTION:

Uni 550, Uni 550M, Uni 378, Uni 378M, Uni 378B, Uni 378B-M, Uni 380, Uni 380M, Uni 380B, Uni 380B-M, Uni 562, Uni 562M, Uni 386, Uni 386M, Uni 602, Uni 602M, Uni 603, Uni 603M, Uni 551M, Uni 551, Uni 552, Uni 552M, Uni 552G, Uni 552M-G, Uni 552T, Uni 552G-T, Uni 558-DP, Uni 558M-DP, Uni 558-DR, Uni 558M-DR, Uni 553, Uni 553M, Uni 577, Uni 577M, Uni 544, Uni 565, Uni 391, Uni 391M, Uni 393, Uni 393M, Uni 220, Uni 221, Uni 222, Uni 223, Trolley 536,



Chair with beech wood frame, 4 legs. Upholstered polypropylene shell.

**WEIGHT**

6,7Kg

**PACK**0,24 m<sup>3</sup>**PIECES PER BOX**

1

## FINISHES SEATING

### TE FABRICS



Citadel Camira  
+ 16 colours



Medley Gabriel  
+ 14 colours



Inca Abitex  
+ 15 colours



Crazy Flukso  
+ 7 colours



Xtreme Camira  
+ 16 colours

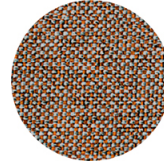

Rivet Camira  
+ 12 colours



Valencia Spradling  
+ 17 colours

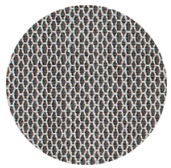

Criss Cross Gabriel  
+ 19 colours

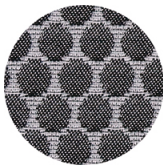

Bubble Flukso  
+ 9 colours



Europost 2 Gabriel  
+ 16 colours



Fame Gabriel  
+ 23 colours



Parotega NF  
Skai Hornschuh  
+ 8 colours

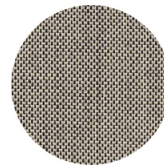

Balta Vescom  
+ 12 colours

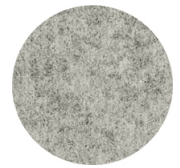

Blazer Camira  
+ 25 colours

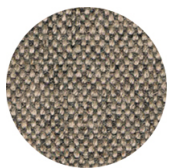

Main line flax Camira  
+ 13 colours

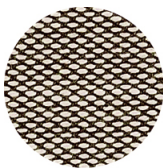

Steelcut trio 3  
Kvadrat  
+ 20 colours

### PP POLYPROPYLENE



RAL 9016 Traffic white

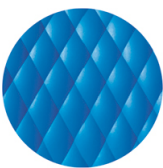

NCS S2060-B Azure



RAL 3000 Flame red



RAL 7016 Anthracite  
grey



RAL 2003 Pastel  
orange

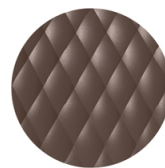

NCS S7005-Y50R  
Cocoa



RAL 9005 Jet black



RAL 4008 Signal violet



PANTONE 380 C  
Boss green



NCS S4005-Y50R  
Turtle-dove



RAL 1004 Golden  
yellow



PANTONE 18-1438  
Marsala

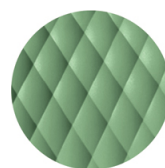

RAL 6021 Pale green



## FRAMES

### LE WOOD



Maple stained beech wood



Natural beech wood



Wengé stained beech wood



Black stained beech wood



"Canaletto" walnut stained beech wood



Oak stained beech wood

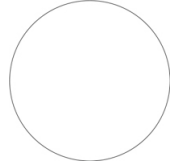

Stained according to sample

## USES

coffee & restaurants, office and waiting areas, outdoor,

## Uni 386

### UNI COLLECTION:

Uni 550, Uni 550M, Uni 378, Uni 378M, Uni 378B, Uni 378B-M, Uni 380, Uni 380M, Uni 380B, Uni 380B-M, Uni 562, Uni 562M, Uni 386, Uni 386M, Uni 602, Uni 602M, Uni 603, Uni 603M, Uni 551M, Uni 551, Uni 552, Uni 552M, Uni 552G, Uni 552M-G, Uni 552T, Uni 552G-T, Uni 558-DP, Uni 558M-DP, Uni 558-DR, Uni 558M-DR, Uni 553, Uni 553M, Uni 577, Uni 577M, Uni 544, Uni 565, Uni 391, Uni 391M, Uni 393, Uni 393M, Uni 220, Uni 221, Uni 222, Uni 223, Trolley 536,



Barstool with beech wood frame, 4 legs. Polypropylene seat and back.

#### WEIGHT

6,3 kg

#### PACK

0,37 m<sup>3</sup>

#### PIECES PER BOX

1

## FINISHES SEATING

### PP POLYPROPYLENE



RAL 9016 Traffic white

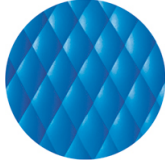

NCS S2060-B Azure



RAL 3000 Flame red



RAL 7016 Anthracite  
grey



RAL 2003 Pastel  
orange

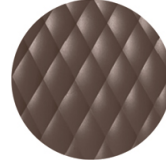

NCS S7005-Y50R  
Cocoa



RAL 9005 Jet black



RAL 4008 Signal violet



PANTONE 380 C  
Boss green



NCS S4005-Y50R  
Turtle-dove



RAL 1004 Golden  
yellow



PANTONE 18-1438  
Marsala

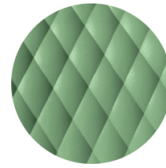

RAL 6021 Pale green

## FRAMES

### LE WOOD



Maple stained beech  
wood



Natural beech wood

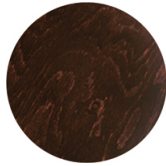

Wengé stained beech  
wood



Black stained beech  
wood



"Canaletto" walnut  
stained beech wood



Oak stained beech  
wood

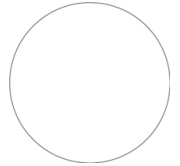

Stained according to  
sample

## USES

coffee & restaurants, office and waiting areas, outdoor,

## Uni 386M



### UNI COLLECTION:

Uni 550, Uni 550M, Uni 378, Uni 378M, Uni 378B, Uni 378B-M, Uni 380, Uni 380M, Uni 380B, Uni 380B-M, Uni 562, Uni 562M, Uni 386, Uni 386M, Uni 602, Uni 602M, Uni 603, Uni 603M, Uni 551M, Uni 551, Uni 552, Uni 552M, Uni 552G, Uni 552M-G, Uni 552T, Uni 552G-T, Uni 558-DP, Uni 558M-DP, Uni 558-DR, Uni 558M-DR, Uni 553, Uni 553M, Uni 577, Uni 577M, Uni 544, Uni 565, Uni 391, Uni 391M, Uni 393, Uni 393M, Uni 220, Uni 221, Uni 222, Uni 223, Trolley 536,



Barstool with beech wood frame, 4 legs. Upholstered polypropylene seat and back.

**WEIGHT**

8,45Kg

**PACK**0,37 m<sup>3</sup>**PIECES PER BOX**

1

## FINISHES SEATING

### TE FABRICS



Citadel Camira  
+ 16 colours



Medley Gabriel  
+ 14 colours



Inca Abitex  
+ 15 colours



Crazy Flukso  
+ 7 colours



Xtreme Camira  
+ 16 colours

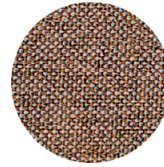

Rivet Camira  
+ 12 colours



Valencia Spradling  
+ 17 colours

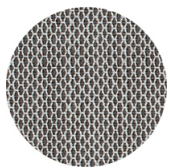

Criss Cross Gabriel  
+ 19 colours

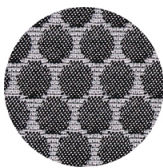

Bubble Flukso  
+ 9 colours



Europost 2 Gabriel  
+ 16 colours



Fame Gabriel  
+ 23 colours



Parotega NF  
Skai Hornschuh  
+ 8 colours

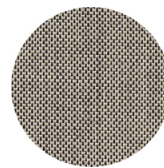

Balta Vescom  
+ 12 colours



Blazer Camira  
+ 25 colours

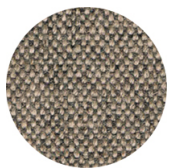

Main line flax Camira  
+ 13 colours

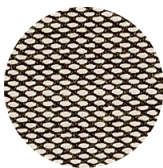

Steelcut trio 3  
Kvadrat  
+ 20 colours

### PP POLYPROPYLENE



RAL 9016 Traffic white

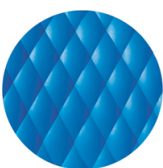

NCS S2060-B Azure



RAL 3000 Flame red



RAL 7016 Anthracite  
grey



RAL 2003 Pastel  
orange

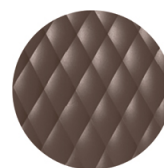

NCS S7005-Y50R  
Cocoa



RAL 9005 Jet black



RAL 4008 Signal violet



PANTONE 380 C  
Boss green



NCS S4005-Y50R  
Turtle-dove



RAL 1004 Golden  
yellow



PANTONE 18-1438  
Marsala

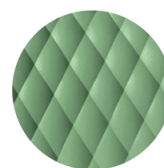

RAL 6021 Pale green

## FRAMES

---

### LE WOOD



Maple stained beech wood



Natural beech wood



Wengé stained beech wood



Black stained beech wood



"Canaletto" walnut stained beech wood



Oak stained beech wood

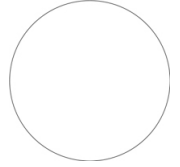

Stained according to sample

## USES

---

coffee & restaurants, office and waiting areas, outdoor,

## Uni 602



### UNI COLLECTION:

Uni 550, Uni 550M, Uni 378, Uni 378M, Uni 378B, Uni 378B-M, Uni 380, Uni 380M, Uni 380B, Uni 380B-M, Uni 562, Uni 562M, Uni 386, Uni 386M, Uni 602, Uni 602M, Uni 603, Uni 603M, Uni 551M, Uni 551, Uni 552, Uni 552M, Uni 552G, Uni 552M-G, Uni 552T, Uni 552G-T, Uni 558-DP, Uni 558M-DP, Uni 558-DR, Uni 558M-DR, Uni 553, Uni 553M, Uni 577, Uni 577M, Uni 544, Uni 565, Uni 391, Uni 391M, Uni 393, Uni 393M, Uni 220, Uni 221, Uni 222, Uni 223, Trolley 536,



Chair with beech wood frame, 4 rounded legs. Polypropylene shell.

**WEIGHT**

4,5 Kg

**PACK**0,29 m<sup>3</sup>**PIECES PER BOX**

2

## FINISHES SEATING

### PP POLYPROPYLENE



RAL 9016 Traffic white



NCS S2060-B Azure



RAL 3000 Flame red



RAL 7016 Anthracite  
grey



RAL 2003 Pastel  
orange

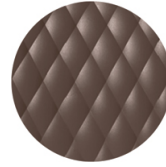

NCS S7005-Y50R  
Cocoa



RAL 9005 Jet black



RAL 4008 Signal violet



PANTONE 380 C  
Boss green



NCS S4005-Y50R  
Turtle-dove



RAL 1004 Golden  
yellow

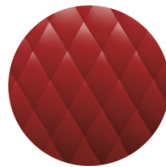

PANTONE 18-1438  
Marsala

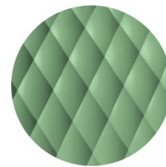

RAL 6021 Pale green

## FRAMES

### LE WOOD



Maple stained beech  
wood



Natural beech wood

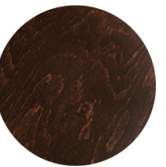

Wengé stained beech  
wood



Black stained beech  
wood



"Canaletto" walnut  
stained beech wood



Oak stained beech  
wood

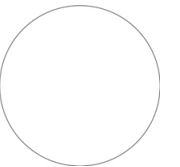

Stained according to  
sample

## CERTIFICATIONS

> UNI/EN 16139:2013 - Par.6. Prova 8. Prova di fatica sedile e schienale: 2-Usò estremo (11/06/17)

## USES

coffee & restaurants, office and waiting areas, outdoor,



## Uni 602M



### UNI COLLECTION:

Uni 550, Uni 550M, Uni 378, Uni 378M, Uni 378B, Uni 378B-M, Uni 380, Uni 380M, Uni 380B, Uni 380B-M, Uni 562, Uni 562M, Uni 386, Uni 386M, Uni 602, Uni 602M, Uni 603, Uni 603M, Uni 551M, Uni 551, Uni 552, Uni 552M, Uni 552G, Uni 552M-G, Uni 552T, Uni 552G-T, Uni 558-DP, Uni 558M-DP, Uni 558-DR, Uni 558M-DR, Uni 553, Uni 553M, Uni 577, Uni 577M, Uni 544, Uni 565, Uni 391, Uni 391M, Uni 393, Uni 393M, Uni 220, Uni 221, Uni 222, Uni 223, Trolley 536,



Chair with beech wood frame, 4 rounded legs. Upholstered polypropylene shell.

**WEIGHT**

6,65 Kg

**PACK**0,24 m<sup>3</sup>**PIECES PER BOX**

1

## FINISHES SEATING

### TE FABRICS



Citadel Camira  
+ 16 colours



Medley Gabriel  
+ 14 colours



Inca Abitex  
+ 15 colours



Crazy Flukso  
+ 7 colours



Xtreme Camira  
+ 16 colours

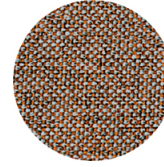

Rivet Camira  
+ 12 colours



Valencia Spradling  
+ 17 colours

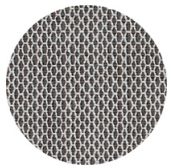

Criss Cross Gabriel  
+ 19 colours

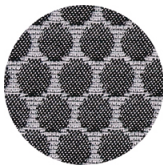

Bubble Flukso  
+ 9 colours



Europost 2 Gabriel  
+ 16 colours



Fame Gabriel  
+ 23 colours



Parotega NF  
Skai Hornschuch  
+ 8 colours

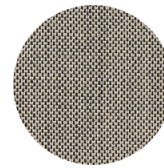

Balta Vescom  
+ 12 colours



Blazer Camira  
+ 25 colours

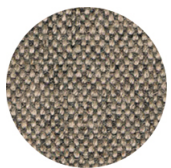

Main line flax Camira  
+ 13 colours

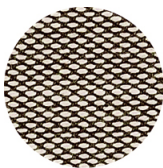

Steelcut trio 3  
Kvadrat  
+ 20 colours

### PP POLYPROPYLENE



RAL 9016 Traffic white

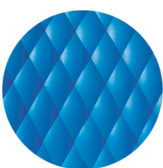

NCS S2060-B Azure



RAL 3000 Flame red



RAL 7016 Anthracite  
grey



RAL 2003 Pastel  
orange

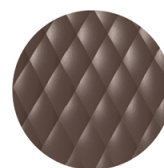

NCS S7005-Y50R  
Cocoa



RAL 9005 Jet black



RAL 4008 Signal violet



PANTONE 380 C  
Boss green



NCS S4005-Y50R  
Turtle-dove



RAL 1004 Golden  
yellow



PANTONE 18-1438  
Marsala

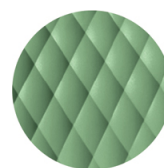

RAL 6021 Pale green

## FRAMES

---

### LE WOOD



Maple stained beech wood



Natural beech wood



Wengé stained beech wood



Black stained beech wood



"Canaletto" walnut stained beech wood



Oak stained beech wood

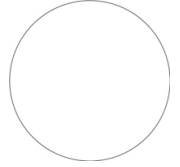

Stained according to sample

## USES

---

coffee & restaurants, office and waiting areas, outdoor,

## Uni 603



### UNI COLLECTION:

Uni 550, Uni 550M, Uni 378, Uni 378M, Uni 378B, Uni 378B-M, Uni 380, Uni 380M, Uni 380B, Uni 380B-M, Uni 562, Uni 562M, Uni 386, Uni 386M, Uni 602, Uni 602M, Uni 603, Uni 603M, Uni 551M, Uni 551, Uni 552, Uni 552M, Uni 552G, Uni 552M-G, Uni 552T, Uni 552G-T, Uni 558-DP, Uni 558M-DP, Uni 558-DR, Uni 558M-DR, Uni 553, Uni 553M, Uni 577, Uni 577M, Uni 544, Uni 565, Uni 391, Uni 391M, Uni 393, Uni 393M, Uni 220, Uni 221, Uni 222, Uni 223, Trolley 536,



Swivel chair with central steel base and polypropylene shell.

**WEIGHT**

8,3 Kg

**PACK**0,24 m<sup>3</sup>**PIECES PER BOX**

1

## FINISHES SEATING

### PP POLYPROPYLENE



RAL 9016 Traffic white



NCS S2060-B Azure



RAL 3000 Flame red



RAL 7016 Anthracite grey



RAL 2003 Pastel orange

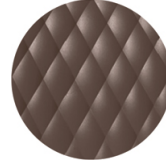

NCS S7005-Y50R Cocoa



RAL 9005 Jet black



RAL 4008 Signal violet



PANTONE 380 C Boss green



NCS S4005-Y50R Turtle-dove



RAL 1004 Golden yellow



PANTONE 18-1438 Marsala

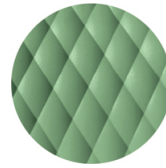

RAL 6021 Pale green

## FRAMES

### AC STEEL



RAL 9016 VR Traffic white



RAL 9010 VR Pure white

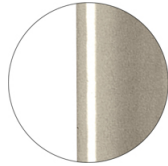

PANTONE 402 C VR Turtle-dove

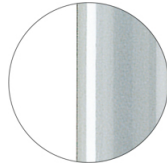

RAL 9006 VR White aluminium

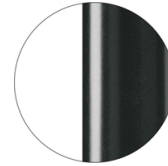

RAL 7016 VR Anthracite grey

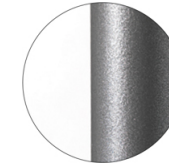

VR Pewter

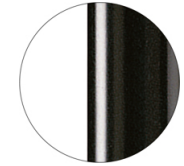

RAL 9005 VR Jet black

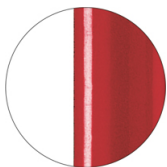

RAL 3003 VR Ruby red

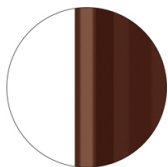

RAL 8017 VR Chocolate brown

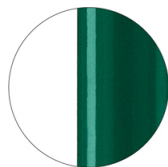

RAL 6005 VR Moss green

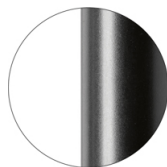

RAL 9005 VR Matt Jet Black

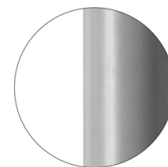

RAL 7037 VR Matt Dusty grey

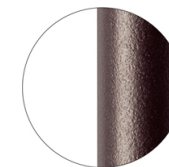

VR Rough metallic bronze



CR Chrome

## USES

coffee & restaurants, office and waiting areas, outdoor,

## Uni 603M



### UNI COLLECTION:

Uni 550, Uni 550M, Uni 378, Uni 378M, Uni 378B, Uni 378B-M, Uni 380, Uni 380M, Uni 380B, Uni 380B-M, Uni 562, Uni 562M, Uni 386, Uni 386M, Uni 602, Uni 602M, Uni 603, Uni 603M, Uni 551M, Uni 551, Uni 552, Uni 552M, Uni 552G, Uni 552M-G, Uni 552T, Uni 552G-T, Uni 558-DP, Uni 558M-DP, Uni 558-DR, Uni 558M-DR, Uni 553, Uni 553M, Uni 577, Uni 577M, Uni 544, Uni 565, Uni 391, Uni 391M, Uni 393, Uni 393M, Uni 220, Uni 221, Uni 222, Uni 223, Trolley 536,



Swivel chair with central steel base. Upholstered polypropylene shell.

**WEIGHT**

10,4 Kg

**PACK**0,24 m<sup>3</sup>**PIECES PER BOX**

1

## FINISHES SEATING

### TE FABRICS



Citadel Camira  
+ 16 colours



Medley Gabriel  
+ 14 colours



Inca Abitex  
+ 15 colours



Crazy Flukso  
+ 7 colours



Xtreme Camira  
+ 16 colours

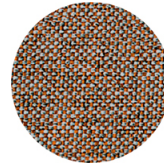

Rivet Camira  
+ 12 colours



Valencia Spradling  
+ 17 colours

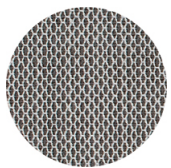

Criss Cross Gabriel  
+ 19 colours

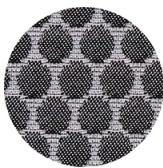

Bubble Flukso  
+ 9 colours



Europost 2 Gabriel  
+ 16 colours



Fame Gabriel  
+ 23 colours



Parotega NF  
Skai Hornschuh  
+ 8 colours

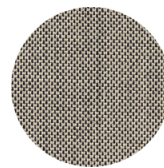

Balta Vescom  
+ 12 colours



Blazer Camira  
+ 25 colours

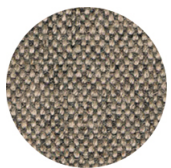

Main line flax Camira  
+ 13 colours

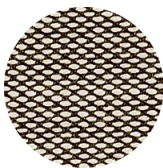

Steelcut trio 3  
Kvadrat  
+ 20 colours

### PP POLYPROPYLENE



RAL 9016 Traffic white



NCS S2060-B Azure



RAL 3000 Flame red



RAL 7016 Anthracite  
grey



RAL 2003 Pastel  
orange

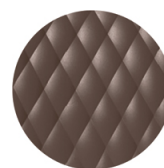

NCS S7005-Y50R  
Cocoa



RAL 9005 Jet black



RAL 4008 Signal violet



PANTONE 380 C  
Boss green



NCS S4005-Y50R  
Turtle-dove



RAL 1004 Golden  
yellow



PANTONE 18-1438  
Marsala

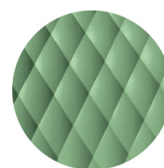

RAL 6021 Pale green

## FRAMES

### AC STEEL



RAL 9016  
VR Traffic white



RAL 9010  
VR Pure white

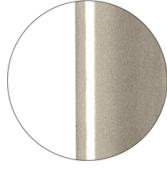

PANTONE 402 C  
VR Turtle-dove

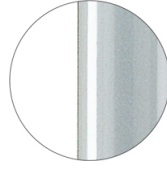

RAL 9006  
VR White aluminium

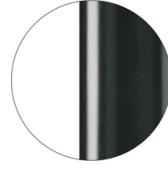

RAL 7016  
VR Anthracite grey

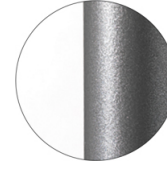

VR Pewter

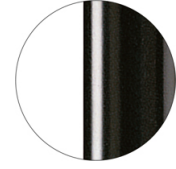

RAL 9005  
VR Jet black

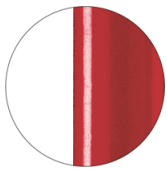

RAL 3003  
VR Ruby red

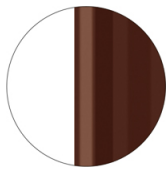

RAL 8017  
VR Chocolate brown

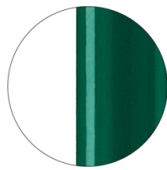

RAL 6005  
VR Moss green

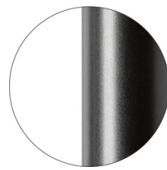

RAL 9005  
VR Matt Jet Black

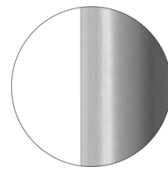

RAL 7037  
VR Matt Dusty grey

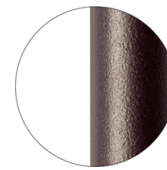

VR Rough metallic  
bronze



CR Chrome

## USES

coffee & restaurants, office and waiting areas, outdoor,



## Uni 551M



### UNI COLLECTION:

Uni 550, Uni 550M, Uni 378, Uni 378M, Uni 378B, Uni 378B-M, Uni 380, Uni 380M, Uni 380B, Uni 380B-M, Uni 562, Uni 562M, Uni 386, Uni 386M, Uni 602, Uni 602M, Uni 603, Uni 603M, Uni 551M, Uni 551, Uni 552, Uni 552M, Uni 552G, Uni 552M-G, Uni 552T, Uni 552G-T, Uni 558-DP, Uni 558M-DP, Uni 558-DR, Uni 558M-DR, Uni 553, Uni 553M, Uni 577, Uni 577M, Uni 544, Uni 565, Uni 391, Uni 391M, Uni 393, Uni 393M, Uni 220, Uni 221, Uni 222, Uni 223, Trolley 536,



Chair with armrests and steel frame, 4 legs. Upholstered polypropylene shell.

**WEIGHT**

7,65 Kg

**PACK**0,39 m<sup>3</sup>**PIECES PER BOX**

1

## FINISHES SEATING

### TE FABRICS



Citadel Camira  
+ 16 colours



Medley Gabriel  
+ 14 colours



Inca Abitex  
+ 15 colours



Crazy Flukso  
+ 7 colours

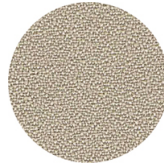

Xtreme Camira  
+ 16 colours

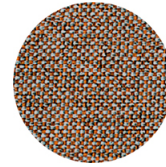

Rivet Camira  
+ 12 colours



Valencia Spradling  
+ 17 colours

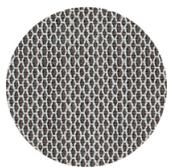

Criss Cross Gabriel  
+ 19 colours

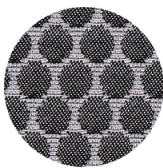

Bubble Flukso  
+ 9 colours



Europost 2 Gabriel  
+ 16 colours



Fame Gabriel  
+ 23 colours



Parotega NF  
Skai Hornschuh  
+ 8 colours

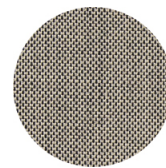

Balta Vescom  
+ 12 colours

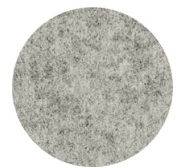

Blazer Camira  
+ 25 colours

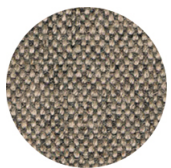

Main line flax Camira  
+ 13 colours

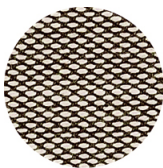

Steelcut trio 3  
Kvadrat  
+ 20 colours

### PP POLYPROPYLENE



RAL 9016 Traffic white

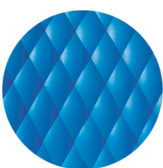

NCS S2060-B Azure



RAL 3000 Flame red



RAL 7016 Anthracite  
grey



RAL 2003 Pastel  
orange

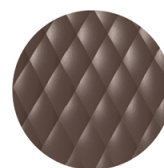

NCS S7005-Y50R  
Cocoa



RAL 9005 Jet black



RAL 4008 Signal violet



PANTONE 380 C  
Boss green



NCS S4005-Y50R  
Turtle-dove



RAL 1004 Golden  
yellow



PANTONE 18-1438  
Marsala

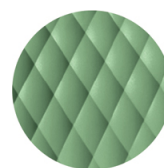

RAL 6021 Pale green

## FRAMES

### AC STEEL



RAL 9016  
VR Traffic white



RAL 9010  
VR Pure white

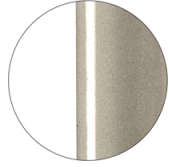

PANTONE 402 C  
VR Turtle-dove

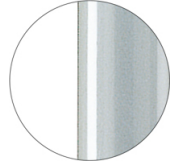

RAL 9006  
VR White aluminium

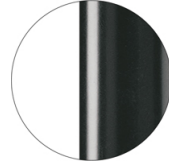

RAL 7016  
VR Anthracite grey

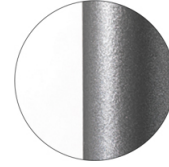

VR Pewter

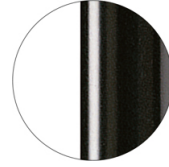

RAL 9005  
VR Jet black

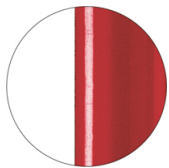

RAL 3003  
VR Ruby red

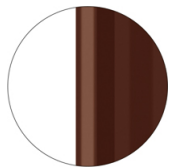

RAL 8017  
VR Chocolate brown

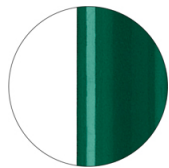

RAL 6005  
VR Moss green

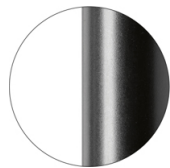

RAL 9005  
VR Matt Jet Black

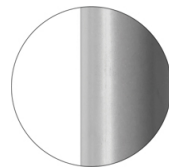

RAL 7037  
VR Matt Dusty grey

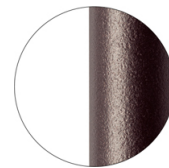

VR Rough metallic  
bronze



CR Chrome

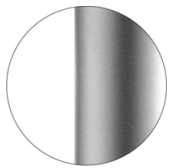

CR S Satin chrome



CR X Brass chrome



CR X Burnished chrome

## USES

coffee & restaurants, office and waiting areas, outdoor,

## Uni 551

### UNI COLLECTION:

Uni 550, Uni 550M, Uni 378, Uni 378M, Uni 378B, Uni 378B-M, Uni 380, Uni 380M, Uni 380B, Uni 380B-M, Uni 562, Uni 562M, Uni 386, Uni 386M, Uni 602, Uni 602M, Uni 603, Uni 603M, Uni 551M, Uni 551, Uni 552, Uni 552M, Uni 552G, Uni 552M-G, Uni 552T, Uni 552G-T, Uni 558-DP, Uni 558M-DP, Uni 558-DR, Uni 558M-DR, Uni 553, Uni 553M, Uni 577, Uni 577M, Uni 544, Uni 565, Uni 391, Uni 391M, Uni 393, Uni 393M, Uni 220, Uni 221, Uni 222, Uni 223, Trolley 536,

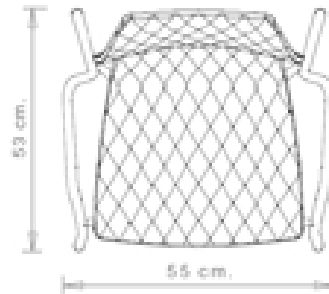

Chair with armrests and steel frame, 4 legs.  
Polypropylene shell.

#### STACKABLE

4

#### WEIGHT

5,5 kg

#### PACK

0,39 m<sup>3</sup>

#### PIECES PER BOX

4

## FINISHES SEATING

### PP POLYPROPYLENE



RAL 9016 Traffic white



NCS S2060-B Azure



RAL 3000 Flame red



RAL 7016 Anthracite  
grey



RAL 2003 Pastel  
orange

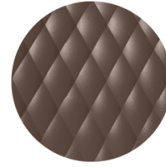

NCS S7005-Y50R  
Cocoa



RAL 9005 Jet black



RAL 4008 Signal violet



PANTONE 380 C  
Boss green



NCS S4005-Y50R  
Turtle-dove



RAL 1004 Golden  
yellow



PANTONE 18-1438  
Marsala

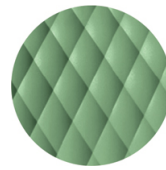

RAL 6021 Pale green

## FRAMES

### AC STEEL



RAL 9016  
VR Traffic white



RAL 9010  
VR Pure white

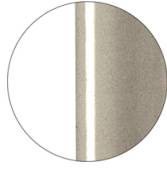

PANTONE 402 C  
VR Turtle-dove

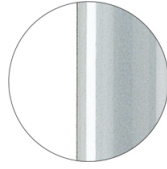

RAL 9006  
VR White aluminium

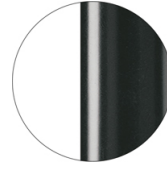

RAL 7016  
VR Anthracite grey

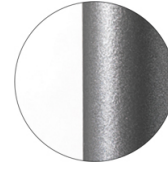

VR Pewter

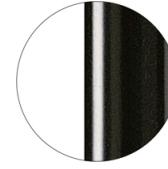

RAL 9005  
VR Jet black

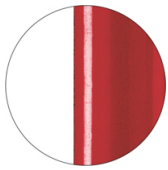

RAL 3003  
VR Ruby red



RAL 8017  
VR Chocolate brown



RAL 6005  
VR Moss green

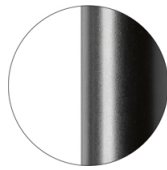

RAL 9005  
VR Matt Jet Black

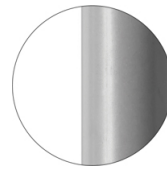

RAL 7037  
VR Matt Dusty grey

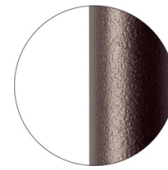

VR Rough metallic  
bronze

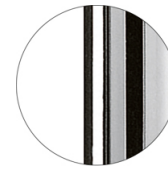

CR Chrome

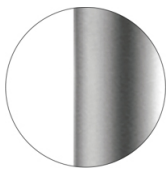

CR S Satin chrome

## USES

coffee & restaurants, office and waiting areas, outdoor,

## Uni 552

### UNI COLLECTION:

Uni 550, Uni 550M, Uni 378, Uni 378M, Uni 378B, Uni 378B-M, Uni 380, Uni 380M, Uni 380B, Uni 380B-M, Uni 562, Uni 562M, Uni 386, Uni 386M, Uni 602, Uni 602M, Uni 603, Uni 603M, Uni 551M, Uni 551, Uni 552, Uni 552M, Uni 552G, Uni 552M-G, Uni 552T, Uni 552G-T, Uni 558-DP, Uni 558M-DP, Uni 558-DR, Uni 558M-DR, Uni 553, Uni 553M, Uni 577, Uni 577M, Uni 544, Uni 565, Uni 391, Uni 391M, Uni 393, Uni 393M, Uni 220, Uni 221, Uni 222, Uni 223, Trolley 536,

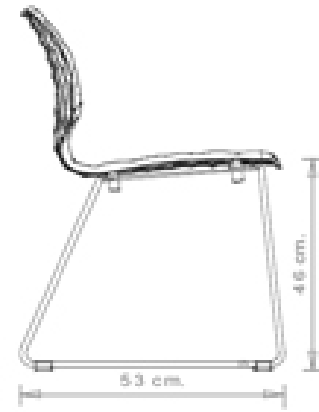
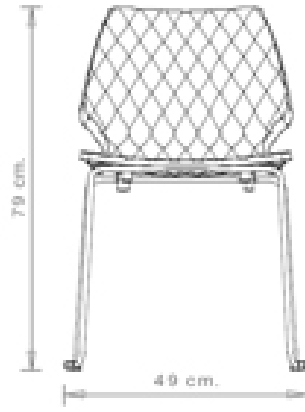

Chair with sled steel frame. Polypropylene shell.

#### STACKABLE

4

#### WEIGHT

6,3 kg

#### PACK

0,39 m<sup>3</sup>

#### PIECES PER BOX

4

## FINISHES SEATING

### PP POLYPROPYLENE



RAL 9016 Traffic white

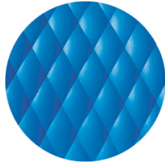

NCS S2060-B Azure



RAL 3000 Flame red



RAL 7016 Anthracite  
grey



RAL 2003 Pastel  
orange

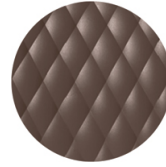

NCS S7005-Y50R  
Cocoa



RAL 9005 Jet black



RAL 4008 Signal violet



PANTONE 380 C  
Boss green



NCS S4005-Y50R  
Turtle-dove



RAL 1004 Golden  
yellow



PANTONE 18-1438  
Marsala

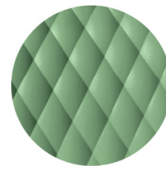

RAL 6021 Pale green



## FRAMES

### AC STEEL



RAL 9016  
VR Traffic white



RAL 9010  
VR Pure white

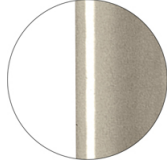

PANTONE 402 C  
VR Turtle-dove

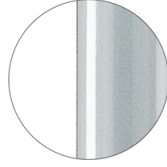

RAL 9006  
VR White aluminium

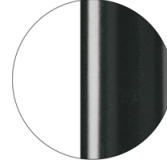

RAL 7016  
VR Anthracite grey

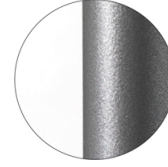

VR Pewter

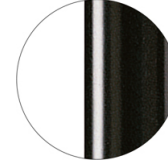

RAL 9005  
VR Jet black

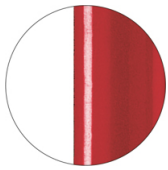

RAL 3003  
VR Ruby red



RAL 8017  
VR Chocolate brown



RAL 6005  
VR Moss green

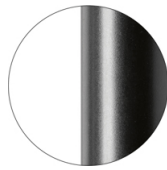

RAL 9005  
VR Matt Jet Black

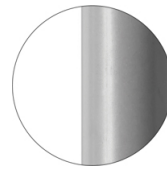

RAL 7037  
VR Matt Dusty grey

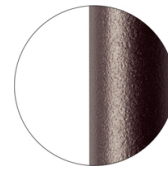

VR Rough metallic  
bronze

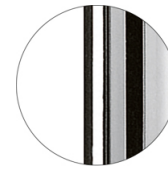

CR Chrome

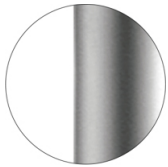

CR S Satin chrome

## USES

coffee & restaurants, office and waiting areas, outdoor,

## Uni 552M



### UNI COLLECTION:

Uni 550, Uni 550M, Uni 378, Uni 378M, Uni 378B, Uni 378B-M, Uni 380, Uni 380M, Uni 380B, Uni 380B-M, Uni 562, Uni 562M, Uni 386, Uni 386M, Uni 602, Uni 602M, Uni 603, Uni 603M, Uni 551M, Uni 551, Uni 552, Uni 552M, Uni 552G, Uni 552M-G, Uni 552T, Uni 552G-T, Uni 558-DP, Uni 558M-DP, Uni 558-DR, Uni 558M-DR, Uni 553, Uni 553M, Uni 577, Uni 577M, Uni 544, Uni 565, Uni 391, Uni 391M, Uni 393, Uni 393M, Uni 220, Uni 221, Uni 222, Uni 223, Trolley 536,



Chair with sled steel frame, upholstered polypropylene shell.

**WEIGHT**

8,4 Kg

**PACK**0,39 m<sup>3</sup>**PIECES PER BOX**

1

## FINISHES SEATING

### TE FABRICS



Citadel Camira  
+ 16 colours



Medley Gabriel  
+ 14 colours



Inca Abitex  
+ 15 colours



Crazy Flukso  
+ 7 colours



Xtreme Camira  
+ 16 colours

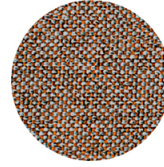

Rivet Camira  
+ 12 colours



Valencia Spradling  
+ 17 colours

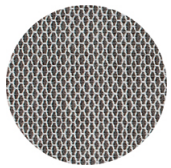

Criss Cross Gabriel  
+ 19 colours

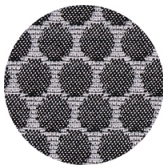

Bubble Flukso  
+ 9 colours



Europost 2 Gabriel  
+ 16 colours



Fame Gabriel  
+ 23 colours



Parotega NF  
Skai Hornschuh  
+ 8 colours

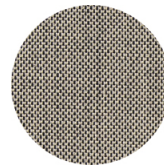

Balta Vescom  
+ 12 colours

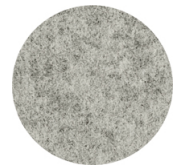

Blazer Camira  
+ 25 colours

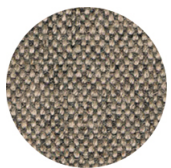

Main line flax Camira  
+ 13 colours

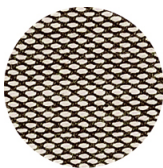

Steelcut trio 3  
Kvadrat  
+ 20 colours

### PP POLYPROPYLENE



RAL 9016 Traffic white

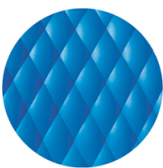

NCS S2060-B Azure



RAL 3000 Flame red



RAL 7016 Anthracite  
grey



RAL 2003 Pastel  
orange

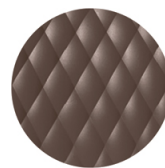

NCS S7005-Y50R  
Cocoa



RAL 9005 Jet black



RAL 4008 Signal violet



PANTONE 380 C  
Boss green



NCS S4005-Y50R  
Turtle-dove



RAL 1004 Golden  
yellow



PANTONE 18-1438  
Marsala

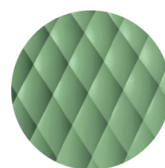

RAL 6021 Pale green

## FRAMES

### AC STEEL



RAL 9016  
VR Traffic white



RAL 9010  
VR Pure white

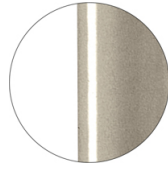

PANTONE 402 C  
VR Turtle-dove

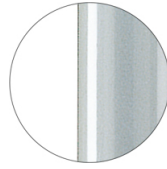

RAL 9006  
VR White aluminium

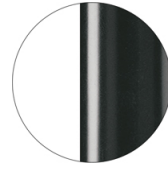

RAL 7016  
VR Anthracite grey

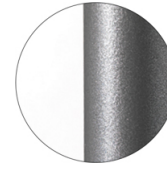

VR Pewter

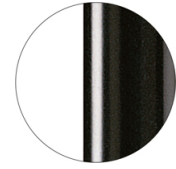

RAL 9005  
VR Jet black

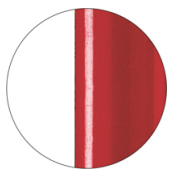

RAL 3003  
VR Ruby red

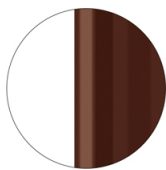

RAL 8017  
VR Chocolate brown

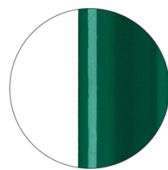

RAL 6005  
VR Moss green

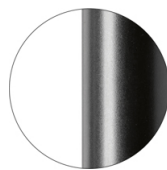

RAL 9005  
VR Matt Jet Black

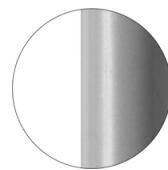

RAL 7037  
VR Matt Dusty grey

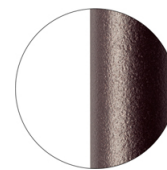

VR Rough metallic  
bronze



CR Chrome

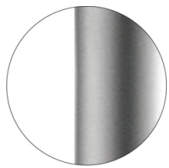

CR S Satin chrome

## USES

coffee & restaurants, office and waiting areas, outdoor,

## Uni 552G

### UNI COLLECTION:

Uni 550, Uni 550M, Uni 378, Uni 378M, Uni 378B, Uni 378B-M, Uni 380, Uni 380M, Uni 380B, Uni 380B-M, Uni 562, Uni 562M, Uni 386, Uni 386M, Uni 602, Uni 602M, Uni 603, Uni 603M, Uni 551M, Uni 551, Uni 552, Uni 552M, Uni 552G, Uni 552M-G, Uni 552T, Uni 552G-T, Uni 558-DP, Uni 558M-DP, Uni 558-DR, Uni 558M-DR, Uni 553, Uni 553M, Uni 577, Uni 577M, Uni 544, Uni 565, Uni 391, Uni 391M, Uni 393, Uni 393M, Uni 220, Uni 221, Uni 222, Uni 223, Trolley 536,

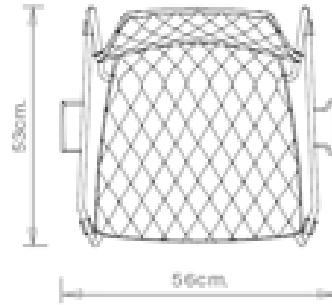
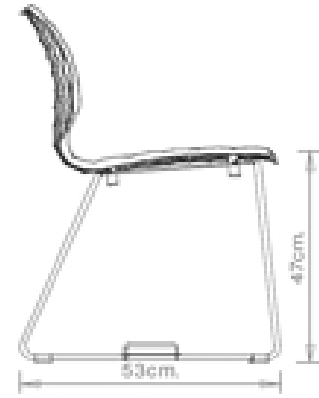

Chair with sled steel frame and linking device.  
Polypropylene shell.

#### STACKABLE

4

#### WEIGHT

6,4 kg

#### PACK

0,39 m<sup>3</sup>

#### PIECES PER BOX

4

## FINISHES SEATING

### PP POLYPROPYLENE



RAL 9016 Traffic white



NCS S2060-B Azure



RAL 3000 Flame red



RAL 7016 Anthracite  
grey



RAL 2003 Pastel  
orange

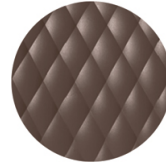

NCS S7005-Y50R  
Cocoa



RAL 9005 Jet black



RAL 4008 Signal violet



PANTONE 380 C  
Boss green



NCS S4005-Y50R  
Turtle-dove



RAL 1004 Golden  
yellow



PANTONE 18-1438  
Marsala

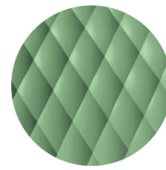

RAL 6021 Pale green

## FRAMES

### AC STEEL



RAL 9016  
VR Traffic white



RAL 9010  
VR Pure white

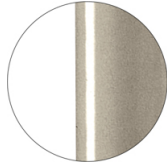

PANTONE 402 C  
VR Turtle-dove

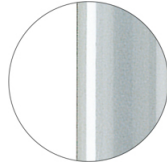

RAL 9006  
VR White aluminium

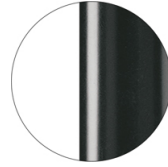

RAL 7016  
VR Anthracite grey

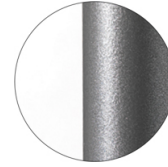

VR Pewter

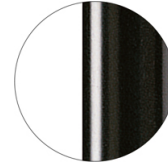

RAL 9005  
VR Jet black

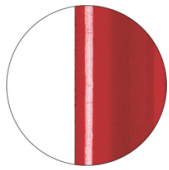

RAL 3003  
VR Ruby red



RAL 8017  
VR Chocolate brown



RAL 6005  
VR Moss green

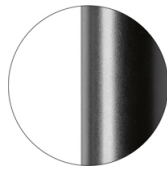

RAL 9005  
VR Matt Jet Black

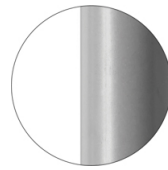

RAL 7037  
VR Matt Dusty grey

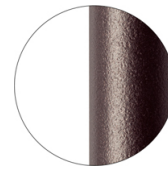

VR Rough metallic  
bronze



CR Chrome

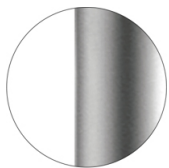

CR S Satin chrome



LINKING DEVICE

## USES

coffee & restaurants, office and waiting areas, outdoor,

## Uni 552M-G



### UNI COLLECTION:

Uni 550, Uni 550M, Uni 378, Uni 378M, Uni 378B, Uni 378B-M, Uni 380, Uni 380M, Uni 380B, Uni 380B-M, Uni 562, Uni 562M, Uni 386, Uni 386M, Uni 602, Uni 602M, Uni 603, Uni 603M, Uni 551M, Uni 551, Uni 552, Uni 552M, Uni 552G, Uni 552M-G, Uni 552T, Uni 552G-T, Uni 558-DP, Uni 558M-DP, Uni 558-DR, Uni 558M-DR, Uni 553, Uni 553M, Uni 577, Uni 577M, Uni 544, Uni 565, Uni 391, Uni 391M, Uni 393, Uni 393M, Uni 220, Uni 221, Uni 222, Uni 223, Trolley 536,



Chair with sled steel frame and linking device. Upholstered polypropylene shell.

**WEIGHT**

8,5Kg

**PACK**0,39 m<sup>3</sup>**PIECES PER BOX**

1



## FINISHES SEATING

### TE FABRICS



Citadel Camira  
+ 16 colours



Medley Gabriel  
+ 14 colours



Inca Abitex  
+ 15 colours



Crazy Flukso  
+ 7 colours



Xtreme Camira  
+ 16 colours

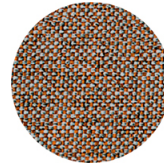

Rivet Camira  
+ 12 colours



Valencia Spradling  
+ 17 colours

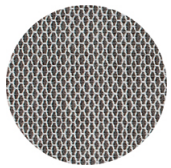

Criss Cross Gabriel  
+ 19 colours

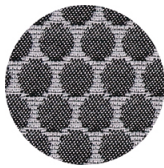

Bubble Flukso  
+ 9 colours



Europost 2 Gabriel  
+ 16 colours



Fame Gabriel  
+ 23 colours



Parotega NF  
Skai Hornschuh  
+ 8 colours

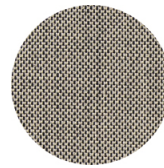

Balta Vescom  
+ 12 colours

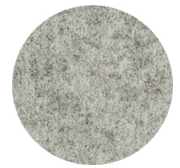

Blazer Camira  
+ 25 colours



Main line flax Camira  
+ 13 colours

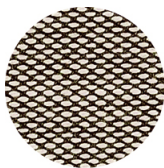

Steelcut trio 3  
Kvadrat  
+ 20 colours

### PP POLYPROPYLENE



RAL 9016 Traffic white



NCS S2060-B Azure



RAL 3000 Flame red



RAL 7016 Anthracite  
grey



RAL 2003 Pastel  
orange

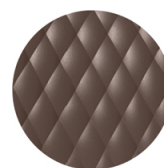

NCS S7005-Y50R  
Cocoa



RAL 9005 Jet black



RAL 4008 Signal violet



PANTONE 380 C  
Boss green



NCS S4005-Y50R  
Turtle-dove



RAL 1004 Golden  
yellow



PANTONE 18-1438  
Marsala

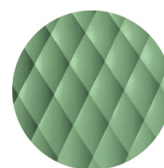

RAL 6021 Pale green

## FRAMES

### AC STEEL



RAL 9016  
VR Traffic white



RAL 9010  
VR Pure white

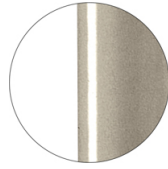

PANTONE 402 C  
VR Turtle-dove

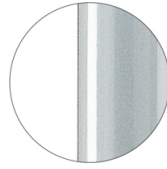

RAL 9006  
VR White aluminium

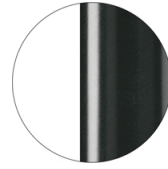

RAL 7016  
VR Anthracite grey

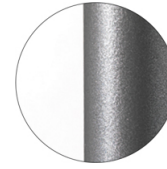

VR Pewter

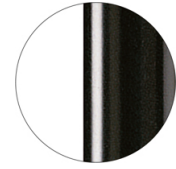

RAL 9005  
VR Jet black

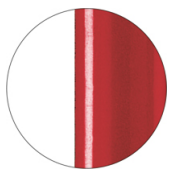

RAL 3003  
VR Ruby red

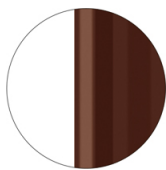

RAL 8017  
VR Chocolate brown

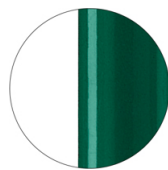

RAL 6005  
VR Moss green

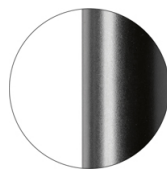

RAL 9005  
VR Matt Jet Black

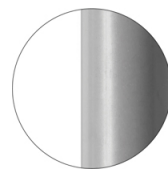

RAL 7037  
VR Matt Dusty grey

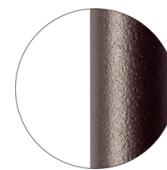

VR Rough metallic  
bronze



CR Chrome

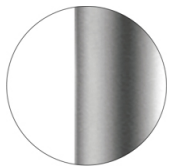

CR S Satin chrome



### LINKING DEVICE

## USES

coffee & restaurants, office and waiting areas, outdoor,

## Uni 552T



### UNI COLLECTION:

Uni 550, Uni 550M, Uni 378, Uni 378M, Uni 378B, Uni 378B-M, Uni 380, Uni 380M, Uni 380B, Uni 380B-M, Uni 562, Uni 562M, Uni 386, Uni 386M, Uni 602, Uni 602M, Uni 603, Uni 603M, Uni 551M, Uni 551, Uni 552, Uni 552M, Uni 552G, Uni 552M-G, Uni 552T, Uni 552G-T, Uni 558-DP, Uni 558M-DP, Uni 558-DR, Uni 558M-DR, Uni 553, Uni 553M, Uni 577, Uni 577M, Uni 544, Uni 565, Uni 391, Uni 391M, Uni 393, Uni 393M, Uni 220, Uni 221, Uni 222, Uni 223, Trolley 536,



Chair with steel sled frame with conference desk kit. Polypropylene shell.

**STACKABLE**

4

**WEIGHT**

7,8 Kg

**PACK**0,39 m<sup>3</sup>**PIECES PER BOX**

4

## FINISHES SEATING

### PP POLYPROPYLENE



RAL 9016 Traffic white

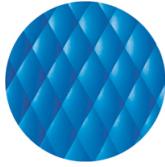

NCS S2060-B Azure



RAL 3000 Flame red



RAL 7016 Anthracite  
grey



RAL 2003 Pastel  
orange

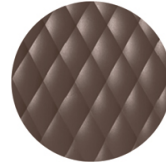

NCS S7005-Y50R  
Cocoa



RAL 9005 Jet black



RAL 4008 Signal violet



PANTONE 380 C  
Boss green

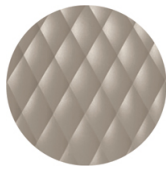

NCS S4005-Y50R  
Turtle-dove



RAL 1004 Golden  
yellow



PANTONE 18-1438  
Marsala

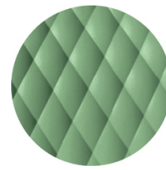

RAL 6021 Pale green

## FRAMES

### AC STEEL



RAL 9016  
VR Traffic white



RAL 9010  
VR Pure white

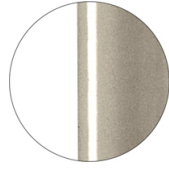

PANTONE 402 C  
VR Turtle-dove

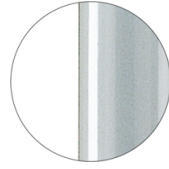

RAL 9006  
VR White aluminium

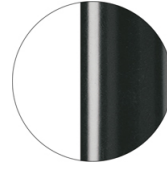

RAL 7016  
VR Anthracite grey

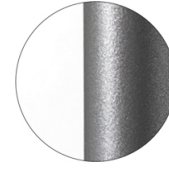

VR Pewter

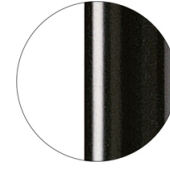

RAL 9005  
VR Jet black

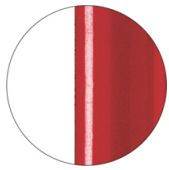

RAL 3003  
VR Ruby red



RAL 8017  
VR Chocolate brown

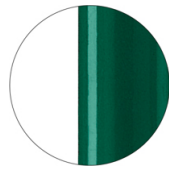

RAL 6005  
VR Moss green

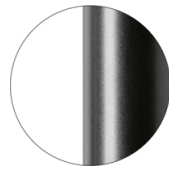

RAL 9005  
VR Matt Jet Black

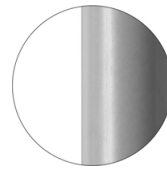

RAL 7037  
VR Matt Dusty grey

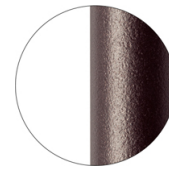

VR Rough metallic  
bronze



CR Chrome

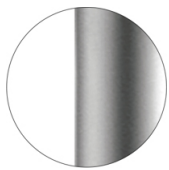

CR S Satin chrome

## CERTIFICATIONS

- > UNI/EN 16139:2013 - Par.4 Sicurezza. 4.3 Stabilità (15/02/17)
- > UNI/EN 16139:2013 - Par.6. Prova 18. Prova di carico statico sulle superfici di scrittura ausiliarie: 2-Uso estremo (15/02/17)
- > UNI/EN 16139:2013 - Par.6. Prova 19. Prova di fatica delle superfici di scrittura ausiliarie: 2-Uso estremo (17702/17)

## USES

coffee & restaurants, office and waiting areas, outdoor,

## Uni 552G-T

### UNI COLLECTION:

Uni 550, Uni 550M, Uni 378, Uni 378M, Uni 378B, Uni 378B-M, Uni 380, Uni 380M, Uni 380B, Uni 380B-M, Uni 562, Uni 562M, Uni 386, Uni 386M, Uni 602, Uni 602M, Uni 603, Uni 603M, Uni 551M, Uni 551, Uni 552, Uni 552M, Uni 552G, Uni 552M-G, Uni 552T, Uni 552G-T, Uni 558-DP, Uni 558M-DP, Uni 558-DR, Uni 558M-DR, Uni 553, Uni 553M, Uni 577, Uni 577M, Uni 544, Uni 565, Uni 391, Uni 391M, Uni 393, Uni 393M, Uni 220, Uni 221, Uni 222, Uni 223, Trolley 536,

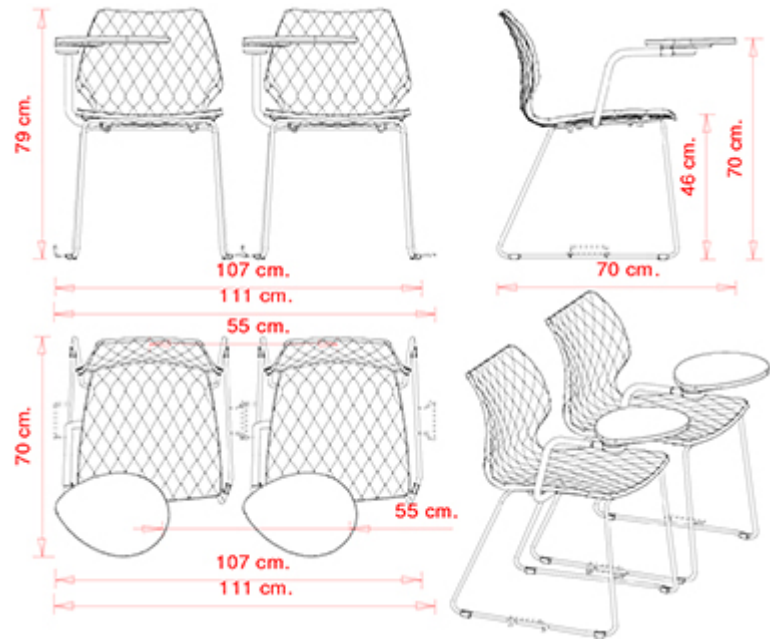

Chair with steel sled frame and linking device with conference desk kit. Polypropylene shell.

### STACKABLE

4

### WEIGHT

7,9 kg

### PACK

0,39 m<sup>3</sup>

### PIECES PER BOX

4

## FINISHES SEATING

### PP POLYPROPYLENE



RAL 9016 Traffic white



NCS S2060-B Azure



RAL 3000 Flame red



RAL 7016 Anthracite  
grey



RAL 2003 Pastel  
orange

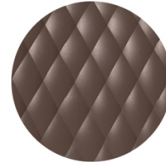

NCS S7005-Y50R  
Cocoa



RAL 9005 Jet black



RAL 4008 Signal violet



PANTONE 380 C  
Boss green



NCS S4005-Y50R  
Turtle-dove



RAL 1004 Golden  
yellow



PANTONE 18-1438  
Marsala

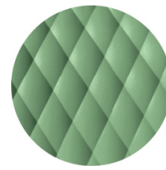

RAL 6021 Pale green

## FRAMES

### AC STEEL



RAL 9016  
VR Traffic white



RAL 9010  
VR Pure white

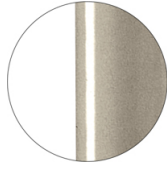

PANTONE 402 C  
VR Turtle-dove

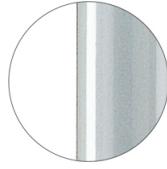

RAL 9006  
VR White aluminium

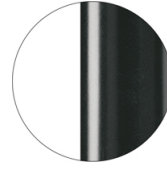

RAL 7016  
VR Anthracite grey

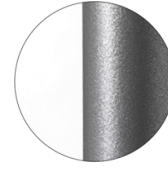

VR Pewter

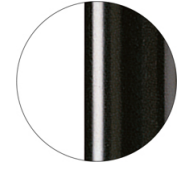

RAL 9005  
VR Jet black

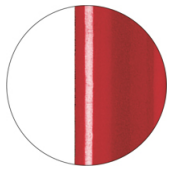

RAL 3003  
VR Ruby red



RAL 8017  
VR Chocolate brown



RAL 6005  
VR Moss green

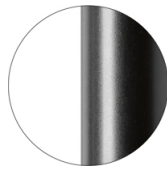

RAL 9005  
VR Matt Jet Black

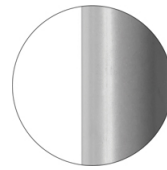

RAL 7037  
VR Matt Dusty grey

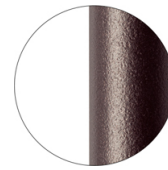

VR Rough metallic  
bronze



CR Chrome

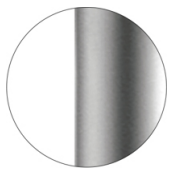

CR S Satin chrome



### LINKING DEVICE

## USES

coffee & restaurants, office and waiting areas, outdoor,



## Uni 558-DP

### UNI COLLECTION:

Uni 550, Uni 550M, Uni 378, Uni 378M, Uni 378B, Uni 378B-M, Uni 380, Uni 380M, Uni 380B, Uni 380B-M, Uni 562, Uni 562M, Uni 386, Uni 386M, Uni 602, Uni 602M, Uni 603, Uni 603M, Uni 551M, Uni 551, Uni 552, Uni 552M, Uni 552G, Uni 552M-G, Uni 552T, Uni 552G-T, Uni 558-DP, Uni 558M-DP, Uni 558-DR, Uni 558M-DR, Uni 553, Uni 553M, Uni 577, Uni 577M, Uni 544, Uni 565, Uni 391, Uni 391M, Uni 393, Uni 393M, Uni 220, Uni 221, Uni 222, Uni 223, Trolley 536,

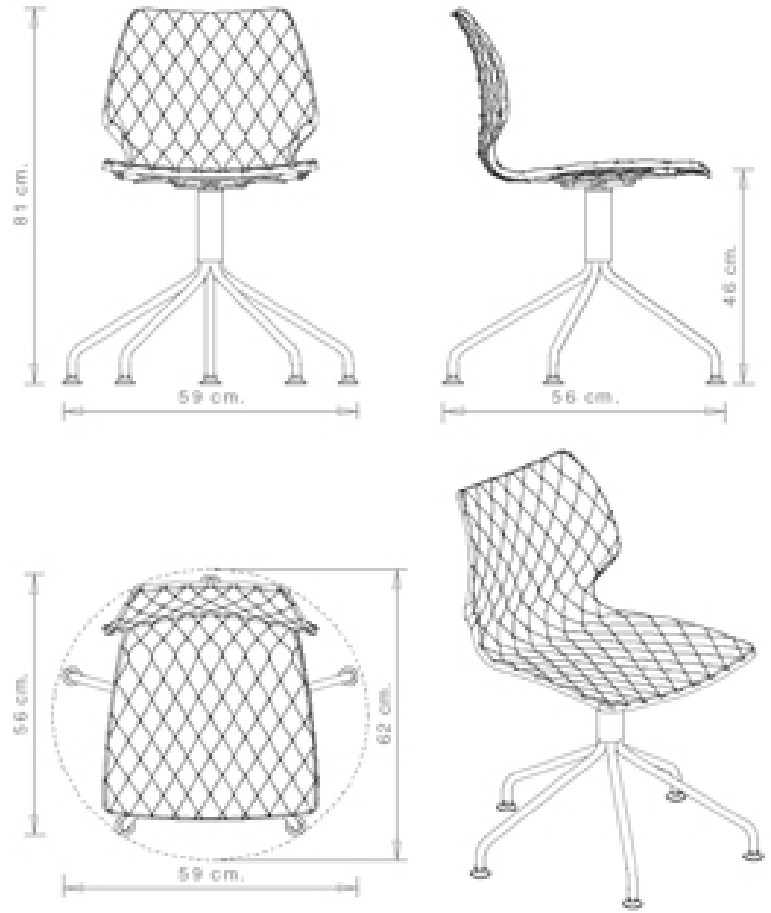

Swivel chair with 5 ways aluminium frame. Polypropylene shell.

#### WEIGHT

6,9 kg

#### PACK

0,50 m<sup>3</sup>

#### PIECES PER BOX

2

## FINISHES SEATING

### PP POLYPROPYLENE



RAL 9016 Traffic white



NCS S2060-B Azure



RAL 3000 Flame red



RAL 7016 Anthracite  
grey



RAL 2003 Pastel  
orange

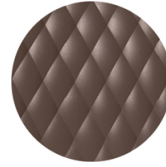

NCS S7005-Y50R  
Cocoa



RAL 9005 Jet black



RAL 4008 Signal violet



PANTONE 380 C  
Boss green



NCS S4005-Y50R  
Turtle-dove



RAL 1004 Golden  
yellow



PANTONE 18-1438  
Marsala

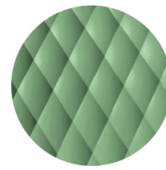

RAL 6021 Pale green

## FRAMES

---

### AL PSH POLISHED ALUMINIUM



Polished aluminium

### AL VR PAINTED ALUMINIUM

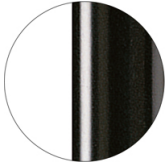

RAL 9005  
VR Jet black

## USES

---

coffee & restaurants, office and waiting areas, outdoor,

## Uni 558M-DP



### UNI COLLECTION:

Uni 550, Uni 550M, Uni 378, Uni 378M, Uni 378B, Uni 378B-M, Uni 380, Uni 380M, Uni 380B, Uni 380B-M, Uni 562, Uni 562M, Uni 386, Uni 386M, Uni 602, Uni 602M, Uni 603, Uni 603M, Uni 551M, Uni 551, Uni 552, Uni 552M, Uni 552G, Uni 552M-G, Uni 552T, Uni 552G-T, Uni 558-DP, Uni 558M-DP, Uni 558-DR, Uni 558M-DR, Uni 553, Uni 553M, Uni 577, Uni 577M, Uni 544, Uni 565, Uni 391, Uni 391M, Uni 393, Uni 393M, Uni 220, Uni 221, Uni 222, Uni 223, Trolley 536,



Swivel chair with 5 ways, aluminium frame. Upholstered polypropylene shell.

**WEIGHT**

8,8 Kg

**PACK**0,50 m<sup>3</sup>**PIECES PER BOX**

1

## FINISHES SEATING

### TE FABRICS



Citadel Camira  
+ 16 colours



Medley Gabriel  
+ 14 colours



Inca Abitex  
+ 15 colours



Crazy Flukso  
+ 7 colours



Xtreme Camira  
+ 16 colours

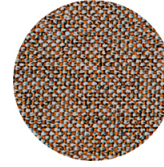

Rivet Camira  
+ 12 colours



Valencia Spradling  
+ 17 colours

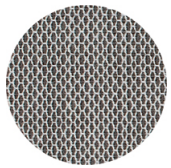

Criss Cross Gabriel  
+ 19 colours

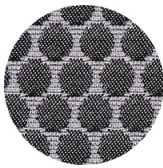

Bubble Flukso  
+ 9 colours



Europost 2 Gabriel  
+ 16 colours



Fame Gabriel  
+ 23 colours



Parotega NF  
Skai Hornschuch  
+ 8 colours

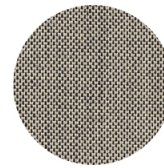

Balta Vescom  
+ 12 colours

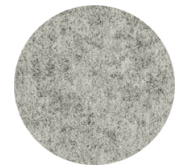

Blazer Camira  
+ 25 colours

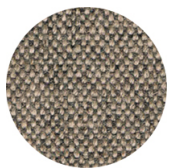

Main line flax Camira  
+ 13 colours

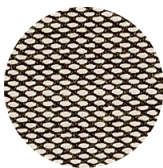

Steelcut trio 3  
Kvadrat  
+ 20 colours

### PP POLYPROPYLENE



RAL 9016 Traffic white

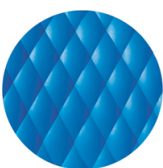

NCS S2060-B Azure



RAL 3000 Flame red



RAL 7016 Anthracite  
grey



RAL 2003 Pastel  
orange

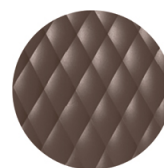

NCS S7005-Y50R  
Cocoa



RAL 9005 Jet black



RAL 4008 Signal violet



PANTONE 380 C  
Boss green



NCS S4005-Y50R  
Turtle-dove



RAL 1004 Golden  
yellow



PANTONE 18-1438  
Marsala

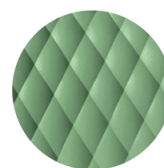

RAL 6021 Pale green

## FRAMES

---

### AL PSH POLISHED ALUMINIUM



Polished aluminium

### AL VR PAINTED ALUMINIUM

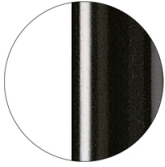

RAL 9005  
VR Jet black

## USES

---

coffee & restaurants, office and waiting areas, outdoor,

## Uni 558-DR

### UNI COLLECTION:

Uni 550, Uni 550M, Uni 378, Uni 378M, Uni 378B, Uni 378B-M, Uni 380, Uni 380M, Uni 380B, Uni 380B-M, Uni 562, Uni 562M, Uni 386, Uni 386M, Uni 602, Uni 602M, Uni 603, Uni 603M, Uni 551M, Uni 551, Uni 552, Uni 552M, Uni 552G, Uni 552M-G, Uni 552T, Uni 552G-T, Uni 558-DP, Uni 558M-DP, Uni 558-DR, Uni 558M-DR, Uni 553, Uni 553M, Uni 577, Uni 577M, Uni 544, Uni 565, Uni 391, Uni 391M, Uni 393, Uni 393M, Uni 220, Uni 221, Uni 222, Uni 223, Trolley 536,

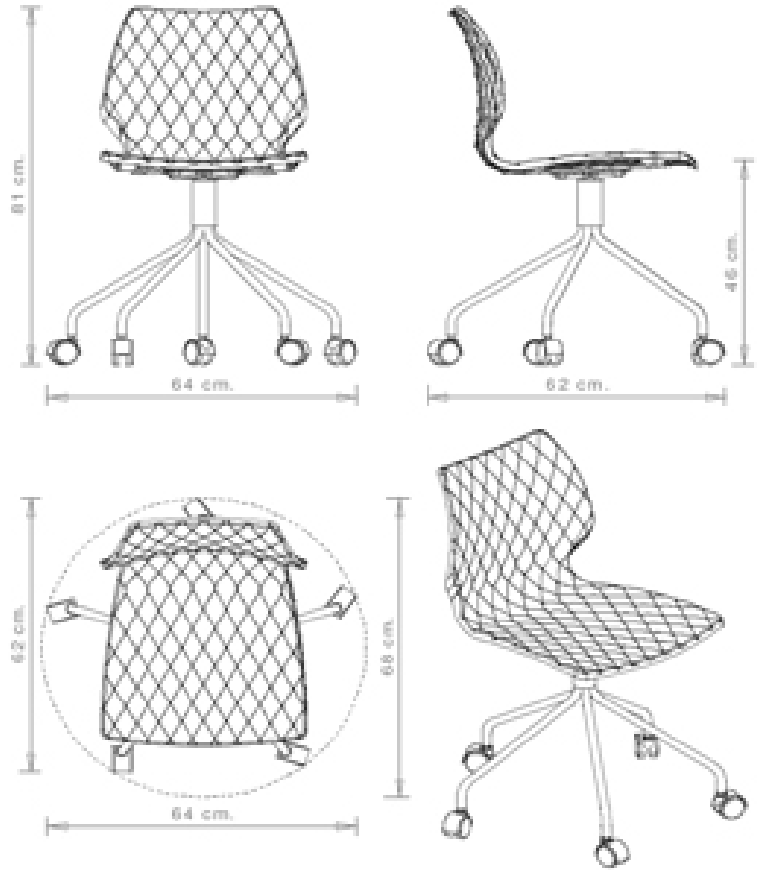

Swivel chair with 5 ways on castors, aluminium frame. Polypropylene shell.

#### WEIGHT

7 kg

#### PACK

0,50 m<sup>3</sup>

#### PIECES PER BOX

2

## FINISHES SEATING

### PP POLYPROPYLENE



RAL 9016 Traffic white

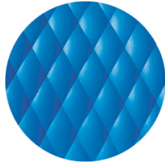

NCS S2060-B Azure



RAL 3000 Flame red



RAL 7016 Anthracite  
grey



RAL 2003 Pastel  
orange

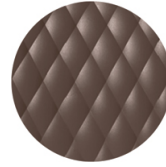

NCS S7005-Y50R  
Cocoa



RAL 9005 Jet black



RAL 4008 Signal violet



PANTONE 380 C  
Boss green



NCS S4005-Y50R  
Turtle-dove



RAL 1004 Golden  
yellow



PANTONE 18-1438  
Marsala

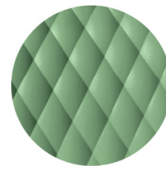

RAL 6021 Pale green



## FRAMES

---

### AL PSH POLISHED ALUMINIUM



Polished aluminium

### AL VR PAINTED ALUMINIUM

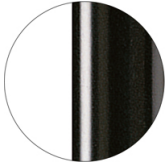

RAL 9005  
VR Jet black

## USES

---

coffee & restaurants, office and waiting areas, outdoor,

## Uni 558M-DR



### UNI COLLECTION:

Uni 550, Uni 550M, Uni 378, Uni 378M, Uni 378B, Uni 378B-M, Uni 380, Uni 380M, Uni 380B, Uni 380B-M, Uni 562, Uni 562M, Uni 386, Uni 386M, Uni 602, Uni 602M, Uni 603, Uni 603M, Uni 551M, Uni 551, Uni 552, Uni 552M, Uni 552G, Uni 552M-G, Uni 552T, Uni 552G-T, Uni 558-DP, Uni 558M-DP, Uni 558-DR, Uni 558M-DR, Uni 553, Uni 553M, Uni 577, Uni 577M, Uni 544, Uni 565, Uni 391, Uni 391M, Uni 393, Uni 393M, Uni 220, Uni 221, Uni 222, Uni 223, Trolley 536,



Swivel chair with 5 ways on castors, aluminium frame. Upholstered polypropylene shell.

**WEIGHT**

8,8 Kg

**PACK**0,50 m<sup>3</sup>**PIECES PER BOX**

1

## FINISHES SEATING

### TE FABRICS



Citadel Camira  
+ 16 colours



Medley Gabriel  
+ 14 colours



Inca Abitex  
+ 15 colours



Crazy Flukso  
+ 7 colours



Xtreme Camira  
+ 16 colours

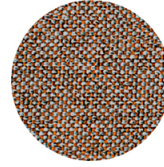

Rivet Camira  
+ 12 colours



Valencia Spradling  
+ 17 colours

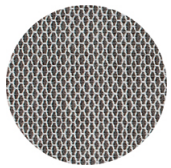

Criss Cross Gabriel  
+ 19 colours

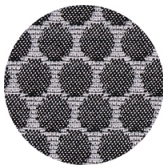

Bubble Flukso  
+ 9 colours



Europost 2 Gabriel  
+ 16 colours



Fame Gabriel  
+ 23 colours



Parotega NF  
Skai Hornschuh  
+ 8 colours

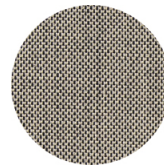

Balta Vescom  
+ 12 colours

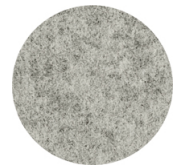

Blazer Camira  
+ 25 colours

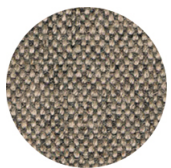

Main line flax Camira  
+ 13 colours

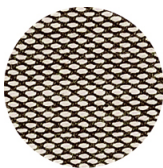

Steelcut trio 3  
Kvadrat  
+ 20 colours

### PP POLYPROPYLENE



RAL 9016 Traffic white

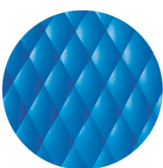

NCS S2060-B Azure



RAL 3000 Flame red



RAL 7016 Anthracite  
grey



RAL 2003 Pastel  
orange

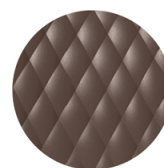

NCS S7005-Y50R  
Cocoa



RAL 9005 Jet black



RAL 4008 Signal violet



PANTONE 380 C  
Boss green



NCS S4005-Y50R  
Turtle-dove



RAL 1004 Golden  
yellow



PANTONE 18-1438  
Marsala

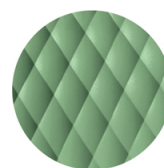

RAL 6021 Pale green

## FRAMES

---

### AL PSH POLISHED ALUMINIUM



Polished aluminium

### AL VR PAINTED ALUMINIUM

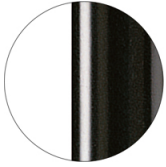

RAL 9005  
VR Jet black

## USES

---

coffee & restaurants, office and waiting areas, outdoor,

## Uni 553

### UNI COLLECTION:

Uni 550, Uni 550M, Uni 378, Uni 378M, Uni 378B, Uni 378B-M, Uni 380, Uni 380M, Uni 380B, Uni 380B-M, Uni 562, Uni 562M, Uni 386, Uni 386M, Uni 602, Uni 602M, Uni 603, Uni 603M, Uni 551M, Uni 551, Uni 552, Uni 552M, Uni 552G, Uni 552M-G, Uni 552T, Uni 552G-T, Uni 558-DP, Uni 558M-DP, Uni 558-DR, Uni 558M-DR, Uni 553, Uni 553M, Uni 577, Uni 577M, Uni 544, Uni 565, Uni 391, Uni 391M, Uni 393, Uni 393M, Uni 220, Uni 221, Uni 222, Uni 223, Trolley 536,

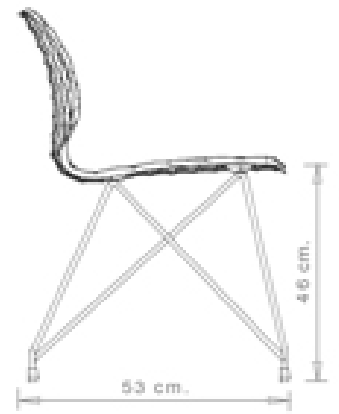

Chair with wire steel frame. Polypropylene shell.

#### WEIGHT

5 kg

#### PACK

0,30 m<sup>3</sup>

#### PIECES PER BOX

2

## FINISHES SEATING

### PP POLYPROPYLENE



RAL 9016 Traffic white



NCS S2060-B Azure



RAL 3000 Flame red



RAL 7016 Anthracite  
grey



RAL 2003 Pastel  
orange

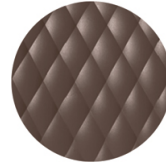

NCS S7005-Y50R  
Cocoa



RAL 9005 Jet black



RAL 4008 Signal violet



PANTONE 380 C  
Boss green



NCS S4005-Y50R  
Turtle-dove



RAL 1004 Golden  
yellow



PANTONE 18-1438  
Marsala

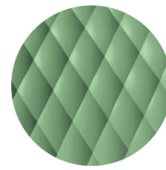

RAL 6021 Pale green

## FRAMES

### AC STEEL



RAL 9016  
VR Traffic white



RAL 9010  
VR Pure white



PANTONE 402 C  
VR Turtle-dove

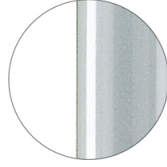

RAL 9006  
VR White aluminium

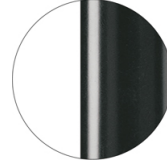

RAL 7016  
VR Anthracite grey

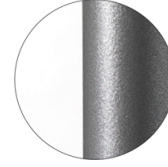

VR Pewter

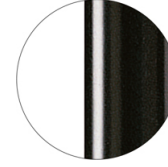

RAL 9005  
VR Jet black

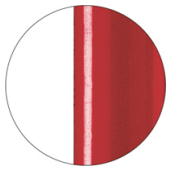

RAL 3003  
VR Ruby red



RAL 8017  
VR Chocolate brown



RAL 6005  
VR Moss green

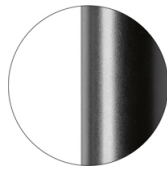

RAL 9005  
VR Matt Jet Black

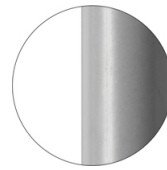

RAL 7037  
VR Matt Dusty grey

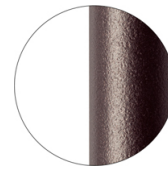

VR Rough metallic  
bronze

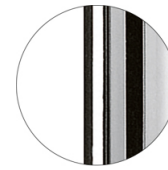

CR Chrome

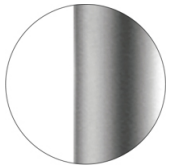

CR S Satin chrome

## USES

coffee & restaurants, office and waiting areas, outdoor,

## Uni 553M



### UNI COLLECTION:

Uni 550, Uni 550M, Uni 378, Uni 378M, Uni 378B, Uni 378B-M, Uni 380, Uni 380M, Uni 380B, Uni 380B-M, Uni 562, Uni 562M, Uni 386, Uni 386M, Uni 602, Uni 602M, Uni 603, Uni 603M, Uni 551M, Uni 551, Uni 552, Uni 552M, Uni 552G, Uni 552M-G, Uni 552T, Uni 552G-T, Uni 558-DP, Uni 558M-DP, Uni 558-DR, Uni 558M-DR, Uni 553, Uni 553M, Uni 577, Uni 577M, Uni 544, Uni 565, Uni 391, Uni 391M, Uni 393, Uni 393M, Uni 220, Uni 221, Uni 222, Uni 223, Trolley 536,



Chair with wire steel frame. Upholstered polypropylene shell.

**WEIGHT**

7,15Kg

**PACK**0,24 m<sup>3</sup>**PIECES PER BOX**

1



## FINISHES SEATING

### TE FABRICS



Citadel Camira  
+ 16 colours



Medley Gabriel  
+ 14 colours



Inca Abitex  
+ 15 colours



Crazy Flukso  
+ 7 colours



Xtreme Camira  
+ 16 colours

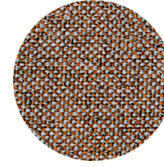

Rivet Camira  
+ 12 colours



Valencia Spradling  
+ 17 colours

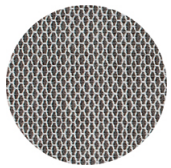

Criss Cross Gabriel  
+ 19 colours

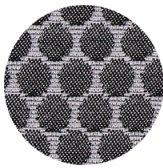

Bubble Flukso  
+ 9 colours



Europost 2 Gabriel  
+ 16 colours



Fame Gabriel  
+ 23 colours



Parotega NF  
Skai Hornschuh  
+ 8 colours

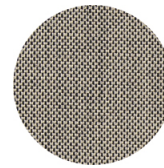

Balta Vescom  
+ 12 colours

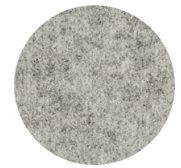

Blazer Camira  
+ 25 colours



Main line flax Camira  
+ 13 colours

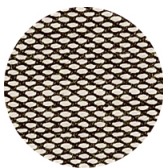

Steelcut trio 3  
Kvadrat  
+ 20 colours

### PP POLYPROPYLENE



RAL 9016 Traffic white

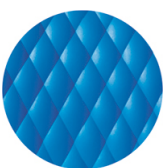

NCS S2060-B Azure



RAL 3000 Flame red



RAL 7016 Anthracite  
grey



RAL 2003 Pastel  
orange

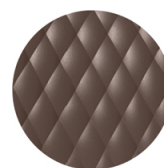

NCS S7005-Y50R  
Cocoa



RAL 9005 Jet black



RAL 4008 Signal violet



PANTONE 380 C  
Boss green



NCS S4005-Y50R  
Turtle-dove



RAL 1004 Golden  
yellow



PANTONE 18-1438  
Marsala

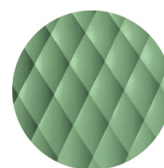

RAL 6021 Pale green

## FRAMES

### AC STEEL



RAL 9016  
VR Traffic white

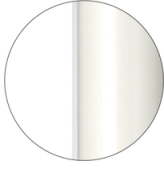

RAL 9010  
VR Pure white

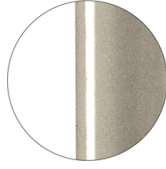

PANTONE 402 C  
VR Turtle-dove

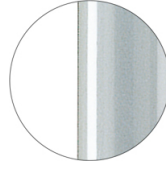

RAL 9006  
VR White aluminium

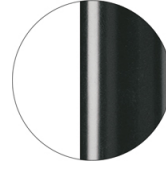

RAL 7016  
VR Anthracite grey

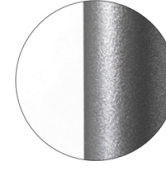

VR Pewter

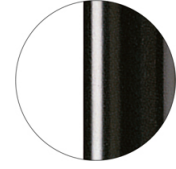

RAL 9005  
VR Jet black

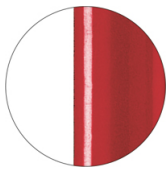

RAL 3003  
VR Ruby red



RAL 8017  
VR Chocolate brown

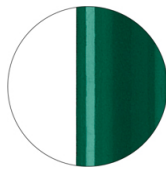

RAL 6005  
VR Moss green

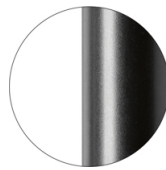

RAL 9005  
VR Matt Jet Black

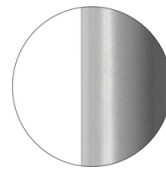

RAL 7037  
VR Matt Dusty grey

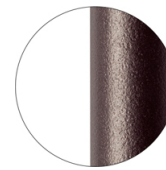

VR Rough metallic  
bronze



CR Chrome

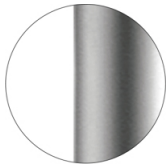

CR S Satin chrome

## USES

coffee & restaurants, office and waiting areas, outdoor,

## Uni 577

### UNI COLLECTION:

Uni 550, Uni 550M, Uni 378, Uni 378M, Uni 378B, Uni 378B-M, Uni 380, Uni 380M, Uni 380B, Uni 380B-M, Uni 562, Uni 562M, Uni 386, Uni 386M, Uni 602, Uni 602M, Uni 603, Uni 603M, Uni 551M, Uni 551, Uni 552, Uni 552M, Uni 552G, Uni 552M-G, Uni 552T, Uni 552G-T, Uni 558-DP, Uni 558M-DP, Uni 558-DR, Uni 558M-DR, Uni 553, Uni 553M, Uni 577, Uni 577M, Uni 544, Uni 565, Uni 391, Uni 391M, Uni 393, Uni 393M, Uni 220, Uni 221, Uni 222, Uni 223, Trolley 536,

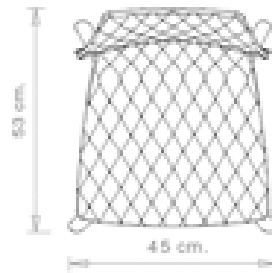

Chair with beech wood frame, 4 rounded legs. Polypropylene shell.

#### WEIGHT

4,7 kg

#### PACK

0,30 m<sup>3</sup>

#### PIECES PER BOX

2

## FINISHES SEATING

### PP POLYPROPYLENE



RAL 9016 Traffic white

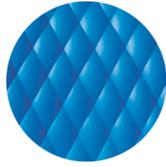

NCS S2060-B Azure



RAL 3000 Flame red



RAL 7016 Anthracite  
grey



RAL 2003 Pastel  
orange

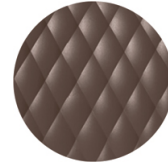

NCS S7005-Y50R  
Cocoa



RAL 9005 Jet black



RAL 4008 Signal violet



PANTONE 380 C  
Boss green



NCS S4005-Y50R  
Turtle-dove



RAL 1004 Golden  
yellow

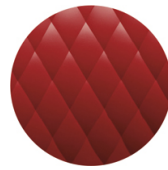

PANTONE 18-1438  
Marsala

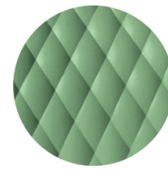

RAL 6021 Pale green

---

**FRAMES**

---

**LE WOOD**

Maple stained beech wood



Natural beech wood



Wengé stained beech wood



Black stained beech wood



'Canaletto' walnut stained beech wood



Oak stained beech wood

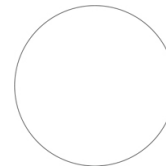

Stained according to sample

---

**CERTIFICATIONS**

---

- > UNI/EN 16139:2013 - Par.4.1. Generale. 4.2 Cesoiamento (27/10/15)
- > UNI/EN 16139:2013 - Par.4.3. Stabilità (27/10/15)
- > UNI/EN 16139:2013 - Par.7. Informazioni per l'uso (27/10/15)
- > UNI/EN 16139:2013 - Prova 1. Carico statico sedile e schienale: 2-Uso estremo (27/10/15)
- > UNI/EN 16139:2013 - Prova 12. Carico statico gambe anteriori: 2-Uso estremo (27/10/15)
- > UNI/EN 16139:2013 - Prova 13. Carico statico gambe laterali: 2-Uso estremo (27/10/15)
- > UNI/EN 16139:2013 - Prova 14. Prova di urto sul sedile: 2-Uso estremo (27/10/15)
- > UNI/EN 16139:2013 - Prova 15. Prova di urto sullo schienale: 2-Uso estremo (27/10/15)
- > UNI/EN 16139:2013 - Prova 2. Carico statico sul fronte anteriore: 2-Uso estremo (27/10/15)
- > UNI/EN 16139:2013 - Prova 3. Carico verticale sullo schienale: 2-Uso estremo (27/10/15)
- > UNI/EN 16139:2013 - Prova 8. Prova di fatica sedile e schienale: 2-Uso estremo (27/10/15)
- > UNI/EN 16139:2013 - Prova 9. Prova di fatica sul bordo anteriore: 2-Uso estremo (27/10/15)

---

**USES**

---

coffee & restaurants, office and waiting areas, outdoor,

## Uni 577M

### UNI COLLECTION:

Uni 550, Uni 550M, Uni 378, Uni 378M, Uni 378B, Uni 378B-M, Uni 380, Uni 380M, Uni 380B, Uni 380B-M, Uni 562, Uni 562M, Uni 386, Uni 386M, Uni 602, Uni 602M, Uni 603, Uni 603M, Uni 551M, Uni 551, Uni 552, Uni 552M, Uni 552G, Uni 552M-G, Uni 552T, Uni 552G-T, Uni 558-DP, Uni 558M-DP, Uni 558-DR, Uni 558M-DR, Uni 553, Uni 553M, Uni 577, Uni 577M, Uni 544, Uni 565, Uni 391, Uni 391M, Uni 393, Uni 393M, Uni 220, Uni 221, Uni 222, Uni 223, Trolley 536,



Chair with beech wood frame, 4 rounded legs. Upholstered polypropylene shell.

**WEIGHT**

6,85 Kg

**PACK**

0,24 m<sup>3</sup>

**PIECES PER BOX**

1

## FINISHES SEATING

### TE FABRICS



Citadel Camira  
+ 16 colours



Medley Gabriel  
+ 14 colours



Inca Abitex  
+ 15 colours



Crazy Flukso  
+ 7 colours



Xtreme Camira  
+ 16 colours

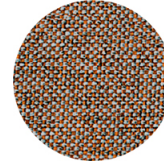

Rivet Camira  
+ 12 colours



Valencia Spradling  
+ 17 colours

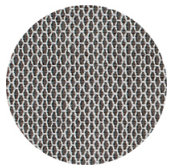

Criss Cross Gabriel  
+ 19 colours

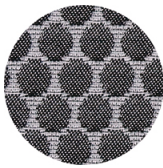

Bubble Flukso  
+ 9 colours



Europost 2 Gabriel  
+ 16 colours



Fame Gabriel  
+ 23 colours



Parotega NF  
Skai Hornschuh  
+ 8 colours

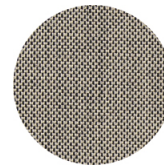

Balta Vescom  
+ 12 colours

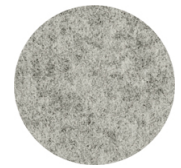

Blazer Camira  
+ 25 colours

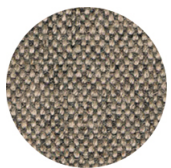

Main line flax Camira  
+ 13 colours

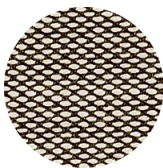

Steelcut trio 3  
Kvadrat  
+ 20 colours

### PP POLYPROPYLENE



RAL 9016 Traffic white

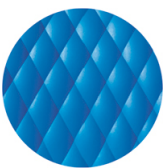

NCS S2060-B Azure



RAL 3000 Flame red

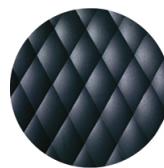

RAL 7016 Anthracite  
grey



RAL 2003 Pastel  
orange

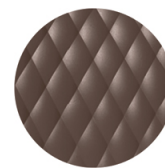

NCS S7005-Y50R  
Cocoa



RAL 9005 Jet black



RAL 4008 Signal violet



PANTONE 380 C  
Boss green



NCS S4005-Y50R  
Turtle-dove



RAL 1004 Golden  
yellow



PANTONE 18-1438  
Marsala

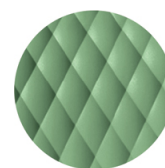

RAL 6021 Pale green

## FRAMES

---

### LE WOOD



Maple stained beech wood



Natural beech wood



Wengé stained beech wood



Black stained beech wood



"Canaletto" walnut stained beech wood



Oak stained beech wood

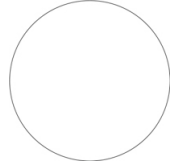

Stained according to sample

## USES

---

coffee & restaurants, office and waiting areas, outdoor,



## Uni 544



### UNI COLLECTION:

Uni 550, Uni 550M, Uni 378, Uni 378M, Uni 378B, Uni 378B-M, Uni 380, Uni 380M, Uni 380B, Uni 380B-M, Uni 562, Uni 562M, Uni 386, Uni 386M, Uni 602, Uni 602M, Uni 603, Uni 603M, Uni 551M, Uni 551, Uni 552, Uni 552M, Uni 552G, Uni 552M-G, Uni 552T, Uni 552G-T, Uni 558-DP, Uni 558M-DP, Uni 558-DR, Uni 558M-DR, Uni 553, Uni 553M, Uni 577, Uni 577M, Uni 544, Uni 565, Uni 391, Uni 391M, Uni 393, Uni 393M, Uni 220, Uni 221, Uni 222, Uni 223, Trolley 536,



Chair with "C" steel frame and polypropylene shell.

**STACKABLE**

4

**WEIGHT**

6,1 kg

**PACK**0,40 m<sup>3</sup>**PIECES PER BOX**

4

## FINISHES SEATING

### PP POLYPROPYLENE



RAL 9016 Traffic white



NCS S2060-B Azure



RAL 3000 Flame red



RAL 7016 Anthracite grey



RAL 2003 Pastel orange

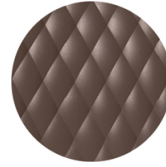

NCS S7005-Y50R Cocoa



RAL 9005 Jet black



RAL 4008 Signal violet



PANTONE 380 C Boss green



NCS S4005-Y50R Turtle-dove



RAL 1004 Golden yellow



PANTONE 18-1438 Marsala

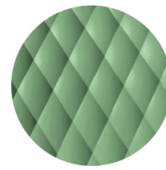

RAL 6021 Pale green

## FRAMES

### AC STEEL



RAL 9016 VR Traffic white



RAL 9010 VR Pure white

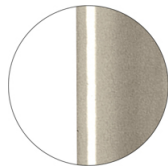

PANTONE 402 C VR Turtle-dove

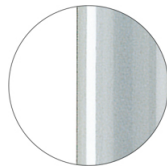

RAL 9006 VR White aluminium

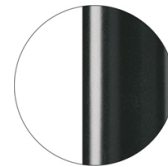

RAL 7016 VR Anthracite grey

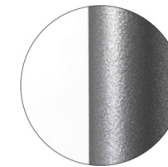

VR Pewter

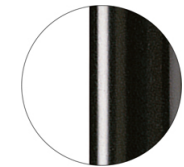

RAL 9005 VR Jet black

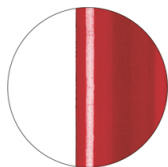

RAL 3003 VR Ruby red

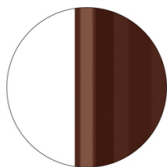

RAL 8017 VR Chocolate brown

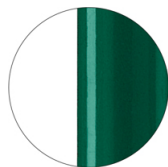

RAL 6005 VR Moss green

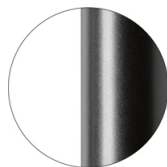

RAL 9005 VR Matt Jet Black

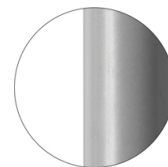

RAL 7037 VR Matt Dusty grey

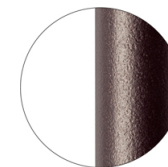

VR Rough metallic bronze

## USES

coffee & restaurants, office and waiting areas, outdoor,

## Uni 565

### UNI COLLECTION:

Uni 550, Uni 550M, Uni 378, Uni 378M, Uni 378B, Uni 378B-M, Uni 380, Uni 380M, Uni 380B, Uni 380B-M, Uni 562, Uni 562M, Uni 386, Uni 386M, Uni 602, Uni 602M, Uni 603, Uni 603M, Uni 551M, Uni 551, Uni 552, Uni 552M, Uni 552G, Uni 552M-G, Uni 552T, Uni 552G-T, Uni 558-DP, Uni 558M-DP, Uni 558-DR, Uni 558M-DR, Uni 553, Uni 553M, Uni 577, Uni 577M, Uni 544, Uni 565, Uni 391, Uni 391M, Uni 393, Uni 393M, Uni 220, Uni 221, Uni 222, Uni 223, Trolley 536,

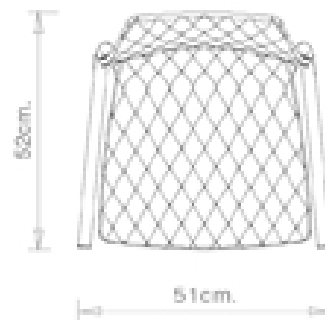

Chair with "C" steel frame and polypropilene shell.

#### WEIGHT

5,2 kg

#### PACK

0,29 m<sup>3</sup>

#### PIECES PER BOX

2

## FINISHES SEATING

### PP POLYPROPYLENE



RAL 9016 Traffic white

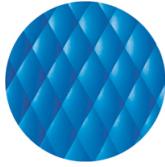

NCS S2060-B Azure



RAL 3000 Flame red



RAL 7016 Anthracite  
grey



RAL 2003 Pastel  
orange

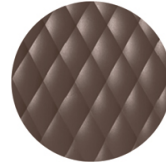

NCS S7005-Y50R  
Cocoa



RAL 9005 Jet black



RAL 4008 Signal violet



PANTONE 380 C  
Boss green

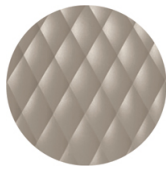

NCS S4005-Y50R  
Turtle-dove



RAL 1004 Golden  
yellow



PANTONE 18-1438  
Marsala

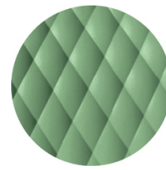

RAL 6021 Pale green

## FRAMES

### AC STEEL



RAL 9016  
VR Traffic white



RAL 9010  
VR Pure white



PANTONE 402 C  
VR Turtle-dove

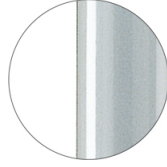

RAL 9006  
VR White aluminium

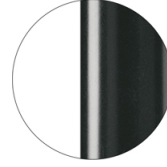

RAL 7016  
VR Anthracite grey

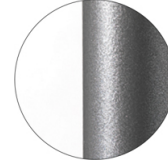

VR Pewter

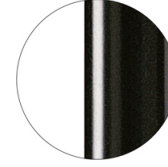

RAL 9005  
VR Jet black

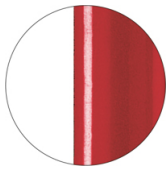

RAL 3003  
VR Ruby red



RAL 8017  
VR Chocolate brown



RAL 6005  
VR Moss green

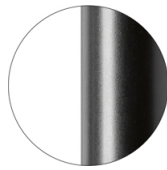

RAL 9005  
VR Matt Jet Black

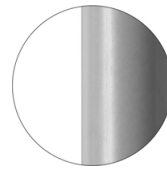

RAL 7037  
VR Matt Dusty grey

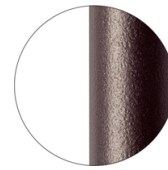

VR Rough metallic  
bronze

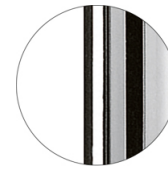

CR Chrome

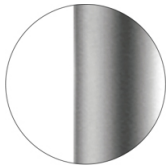

CR S Satin chrome

## USES

coffee & restaurants, office and waiting areas, outdoor,

## Uni 391

### UNI COLLECTION:

Uni 550, Uni 550M, Uni 378, Uni 378M, Uni 378B, Uni 378B-M, Uni 380, Uni 380M, Uni 380B, Uni 380B-M, Uni 562, Uni 562M, Uni 386, Uni 386M, Uni 602, Uni 602M, Uni 603, Uni 603M, Uni 551M, Uni 551, Uni 552, Uni 552M, Uni 552G, Uni 552M-G, Uni 552T, Uni 552G-T, Uni 558-DP, Uni 558M-DP, Uni 558-DR, Uni 558M-DR, Uni 553, Uni 553M, Uni 577, Uni 577M, Uni 544, Uni 565, Uni 391, Uni 391M, Uni 393, Uni 393M, Uni 220, Uni 221, Uni 222, Uni 223, Trolley 536,

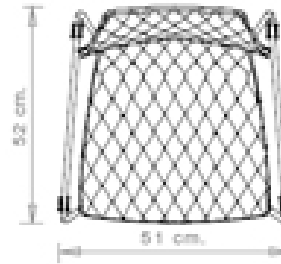

Barstool with steel sled frame, polypropylene shell.

#### WEIGHT

5,1 Kg

#### PACK

0,37 m<sup>3</sup>

#### PIECES PER BOX

1

## FINISHES SEATING

### PP POLYPROPYLENE



RAL 9016 Traffic white

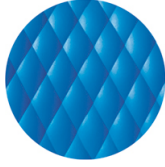

NCS S2060-B Azure



RAL 3000 Flame red



RAL 7016 Anthracite grey



RAL 2003 Pastel orange

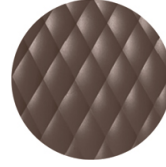

NCS S7005-Y50R Cocoa



RAL 9005 Jet black



RAL 4008 Signal violet



PANTONE 380 C Boss green

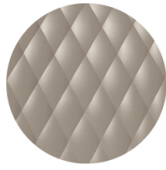

NCS S4005-Y50R Turtle-dove



RAL 1004 Golden yellow



PANTONE 18-1438 Marsala

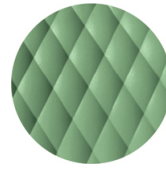

RAL 6021 Pale green

## FRAMES

### AC STEEL



RAL 9016 VR Traffic white



RAL 9010 VR Pure white

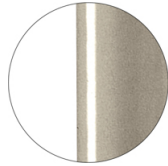

PANTONE 402 C VR Turtle-dove

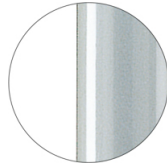

RAL 9006 VR White aluminium

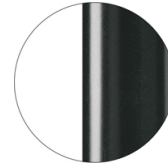

RAL 7016 VR Anthracite grey

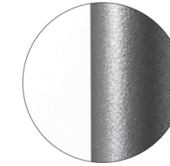

VR Pewter

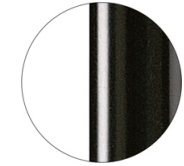

RAL 9005 VR Jet black

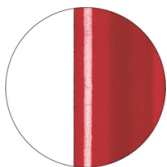

RAL 3003 VR Ruby red

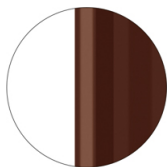

RAL 8017 VR Chocolate brown

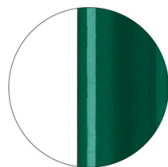

RAL 6005 VR Moss green

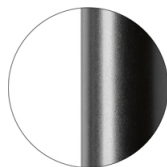

RAL 9005 VR Matt Jet Black

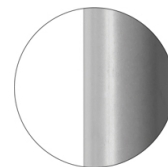

RAL 7037 VR Matt Dusty grey

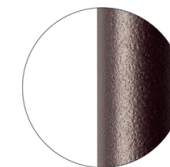

VR Rough metallic bronze



CR Chrome

## USES

coffee & restaurants, office and waiting areas, outdoor,

## Uni 391M



### UNI COLLECTION:

Uni 550, Uni 550M, Uni 378, Uni 378M, Uni 378B, Uni 378B-M, Uni 380, Uni 380M, Uni 380B, Uni 380B-M, Uni 562, Uni 562M, Uni 386, Uni 386M, Uni 602, Uni 602M, Uni 603, Uni 603M, Uni 551M, Uni 551, Uni 552, Uni 552M, Uni 552G, Uni 552M-G, Uni 552T, Uni 552G-T, Uni 558-DP, Uni 558M-DP, Uni 558-DR, Uni 558M-DR, Uni 553, Uni 553M, Uni 577, Uni 577M, Uni 544, Uni 565, Uni 391, Uni 391M, Uni 393, Uni 393M, Uni 220, Uni 221, Uni 222, Uni 223, Trolley 536,



Barstool with steel sled frame, upholstered polypropylene shell.

**WEIGHT**

7,25 Kg

**PACK**0,37 m<sup>3</sup>**PIECES PER BOX**

1



## FINISHES SEATING

### TE FABRICS



Citadel Camira  
+ 16 colours



Medley Gabriel  
+ 14 colours



Inca Abitex  
+ 15 colours



Crazy Flukso  
+ 7 colours



Xtreme Camira  
+ 16 colours

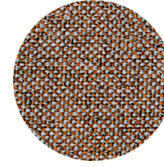

Rivet Camira  
+ 12 colours



Valencia Spradling  
+ 17 colours

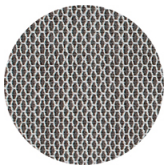

Criss Cross Gabriel  
+ 19 colours

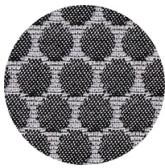

Bubble Flukso  
+ 9 colours



Europost 2 Gabriel  
+ 16 colours



Fame Gabriel  
+ 23 colours



Parotega NF  
Skai Hornschuch  
+ 8 colours



Superb Flukso  
+ 13 colours

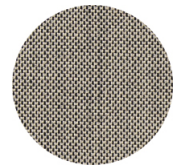

Balta Vescom  
+ 12 colours

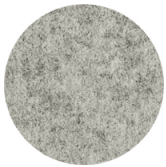

Blazer Camira  
+ 25 colours

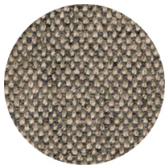

Main line flax Camira  
+ 13 colours

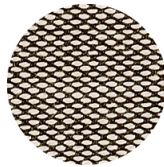

Steelcut trio 3  
Kvadrat  
+ 20 colours

### PP POLYPROPYLENE



RAL 9016 Traffic white

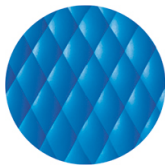

NCS S2060-B Azure



RAL 3000 Flame red



RAL 7016 Anthracite  
grey



RAL 2003 Pastel  
orange

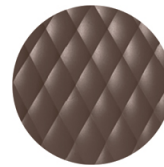

NCS S7005-Y50R  
Cocoa



RAL 9005 Jet black



RAL 4008 Signal violet



PANTONE 380 C  
Boss green



NCS S4005-Y50R  
Turtle-dove



RAL 1004 Golden  
yellow



PANTONE 18-1438  
Marsala

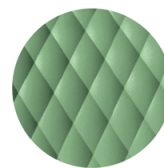

RAL 6021 Pale green

## FRAMES

### AC STEEL



RAL 9016  
VR Traffic white



RAL 9010  
VR Pure white

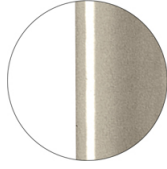

PANTONE 402 C  
VR Turtle-dove

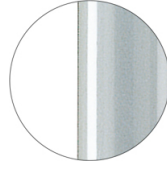

RAL 9006  
VR White aluminium

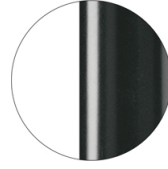

RAL 7016  
VR Anthracite grey

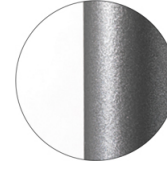

VR Pewter

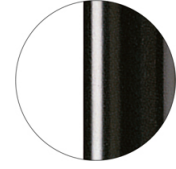

RAL 9005  
VR Jet black

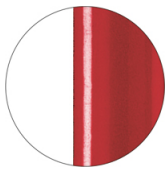

RAL 3003  
VR Ruby red

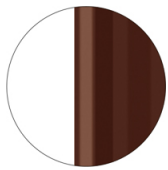

RAL 8017  
VR Chocolate brown



RAL 6005  
VR Moss green

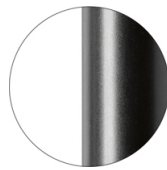

RAL 9005  
VR Matt Jet Black

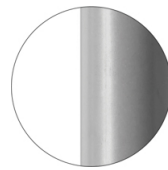

RAL 7037  
VR Matt Dusty grey

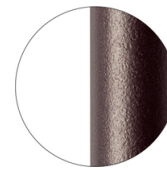

VR Rough metallic  
bronze



CR Chrome

## USES

coffee & restaurants, office and waiting areas, outdoor,

## Uni 393

### UNI COLLECTION:

Uni 550, Uni 550M, Uni 378, Uni 378M, Uni 378B, Uni 378B-M, Uni 380, Uni 380M, Uni 380B, Uni 380B-M, Uni 562, Uni 562M, Uni 386, Uni 386M, Uni 602, Uni 602M, Uni 603, Uni 603M, Uni 551M, Uni 551, Uni 552, Uni 552M, Uni 552G, Uni 552M-G, Uni 552T, Uni 552G-T, Uni 558-DP, Uni 558M-DP, Uni 558-DR, Uni 558M-DR, Uni 553, Uni 553M, Uni 577, Uni 577M, Uni 544, Uni 565, Uni 391, Uni 391M, Uni 393, Uni 393M, Uni 220, Uni 221, Uni 222, Uni 223, Trolley 536,

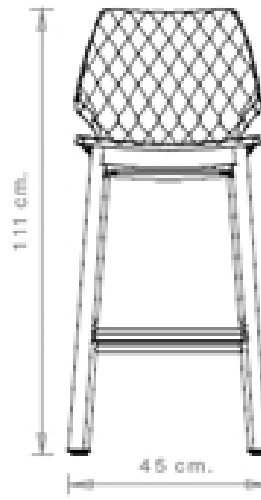

Barstool with wooden frame, 4 round legs. Polypropylene shell.

#### WEIGHT

6,6 kg

#### PACK

0,37 m<sup>3</sup>

#### PIECES PER BOX

1

## FINISHES SEATING

### PP POLYPROPYLENE



RAL 9016 Traffic white

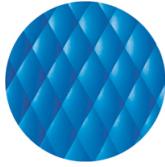

NCS S2060-B Azure



RAL 3000 Flame red



RAL 7016 Anthracite  
grey



RAL 2003 Pastel  
orange

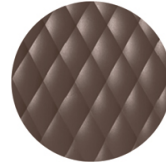

NCS S7005-Y50R  
Cocoa



RAL 9005 Jet black



RAL 4008 Signal violet



PANTONE 380 C  
Boss green

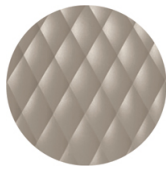

NCS S4005-Y50R  
Turtle-dove



RAL 1004 Golden  
yellow



PANTONE 18-1438  
Marsala

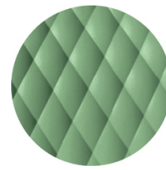

RAL 6021 Pale green

---

**FRAMES**

---

**LE WOOD**

Maple stained beech wood



Natural beech wood



Wengé stained beech wood



Black stained beech wood



'Canaletto' walnut stained beech wood



Oak stained beech wood

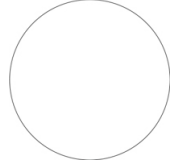

Stained according to sample

---

**CERTIFICATIONS**

---

- > UNI/EN 16139:2013 - Prova 11. Prova di durata appoggiapiedi: 1-Uso generale (08/02/16)
- > UNI/EN 16139:2013 - Prova 12. Prova di carico statico gambe anteriori: 1-Uso generale (08/02/16)
- > UNI/EN 16139:2013 - Prova 13. Prova di carico statico gambe laterali: 1-Uso generale (08/02/16)
- > UNI/EN 16139:2013 - Prova 4. Prova carico statico appoggiapiedi: 1-Uso generale (08/02/16)
- > UNI/EN 16139:2013 - Prova 8. Prova di fatica sedile e schienale: 1-Uso generale (08/02/16)

---

**USES**

---

coffee & restaurants, office and waiting areas, outdoor,

## Uni 393M



### UNI COLLECTION:

Uni 550, Uni 550M, Uni 378, Uni 378M, Uni 378B, Uni 378B-M, Uni 380, Uni 380M, Uni 380B, Uni 380B-M, Uni 562, Uni 562M, Uni 386, Uni 386M, Uni 602, Uni 602M, Uni 603, Uni 603M, Uni 551M, Uni 551, Uni 552, Uni 552M, Uni 552G, Uni 552M-G, Uni 552T, Uni 552G-T, Uni 558-DP, Uni 558M-DP, Uni 558-DR, Uni 558M-DR, Uni 553, Uni 553M, Uni 577, Uni 577M, Uni 544, Uni 565, Uni 391, Uni 391M, Uni 393, Uni 393M, Uni 220, Uni 221, Uni 222, Uni 223, Trolley 536,



Barstool with wooden frame, 4 round legs. Upholstered polypropylene shell.

**WEIGHT**

8,75 Kg

**PACK**0,37 m<sup>3</sup>**PIECES PER BOX**

1

## FINISHES SEATING

### TE FABRICS



Citadel Camira  
+ 16 colours



Medley Gabriel  
+ 14 colours



Inca Abitex  
+ 15 colours



Crazy Flukso  
+ 7 colours



Xtreme Camira  
+ 16 colours

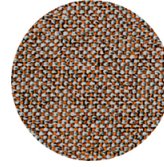

Rivet Camira  
+ 12 colours



Valencia Spradling  
+ 17 colours

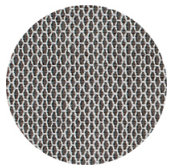

Criss Cross Gabriel  
+ 19 colours

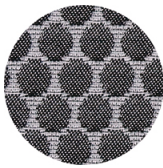

Bubble Flukso  
+ 9 colours



Europost 2 Gabriel  
+ 16 colours



Fame Gabriel  
+ 23 colours



Parotega NF  
Skai Hornschuh  
+ 8 colours

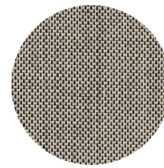

Balta Vescom  
+ 12 colours

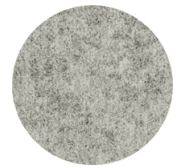

Blazer Camira  
+ 25 colours

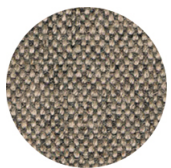

Main line flax Camira  
+ 13 colours

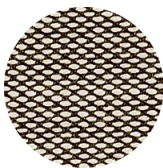

Steelcut trio 3  
Kvadrat  
+ 20 colours

### PP POLYPROPYLENE



RAL 9016 Traffic white



NCS S2060-B Azure



RAL 3000 Flame red



RAL 7016 Anthracite  
grey



RAL 2003 Pastel  
orange

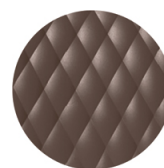

NCS S7005-Y50R  
Cocoa



RAL 9005 Jet black



RAL 4008 Signal violet



PANTONE 380 C  
Boss green



NCS S4005-Y50R  
Turtle-dove



RAL 1004 Golden  
yellow



PANTONE 18-1438  
Marsala

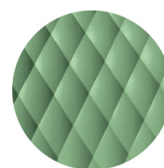

RAL 6021 Pale green

## FRAMES

---

### LE WOOD



Maple stained beech wood



Natural beech wood



Wengé stained beech wood



Black stained beech wood



"Canaletto" walnut stained beech wood



Oak stained beech wood

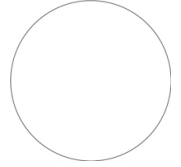

Stained according to sample

## USES

---

coffee & restaurants, office and waiting areas, outdoor,



## Uni 220

### UNI COLLECTION:

Uni 550, Uni 550M, Uni 378, Uni 378M, Uni 378B, Uni 378B-M, Uni 380, Uni 380M, Uni 380B, Uni 380B-M, Uni 562, Uni 562M, Uni 386, Uni 386M, Uni 602, Uni 602M, Uni 603, Uni 603M, Uni 551M, Uni 551, Uni 552, Uni 552M, Uni 552G, Uni 552M-G, Uni 552T, Uni 552G-T, Uni 558-DP, Uni 558M-DP, Uni 558-DR, Uni 558M-DR, Uni 553, Uni 553M, Uni 577, Uni 577M, Uni 544, Uni 565, Uni 391, Uni 391M, Uni 393, Uni 393M, Uni 220, Uni 221, Uni 222, Uni 223, Trolley 536,

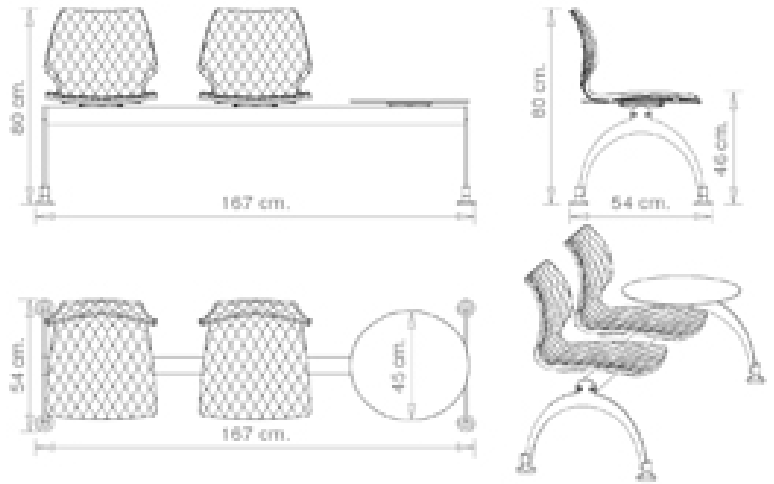

Seating system on bar, 2 seats with shelf; steel frame, polypropylene seat.

#### WEIGHT

24,6 kg

#### PACK

0,89 m<sup>3</sup>

#### PIECES PER BOX

1

## FINISHES SEATING

### PP POLYPROPYLENE



RAL 9016 Traffic white

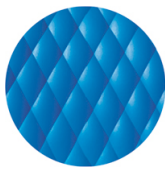

NCS S2060-B Azure



RAL 3000 Flame red



RAL 7016 Anthracite grey



RAL 2003 Pastel orange

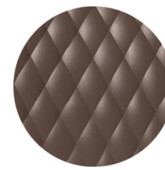

NCS S7005-Y50R Cocoa



RAL 9005 Jet black



RAL 4008 Signal violet



PANTONE 380 C Boss green



NCS S4005-Y50R Turtle-dove



RAL 1004 Golden yellow

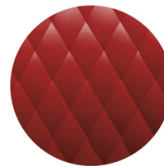

PANTONE 18-1438 Marsala

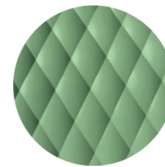

RAL 6021 Pale green

## FRAMES

### AC STEEL



RAL 9016  
VR Traffic white



RAL 9010  
VR Pure white

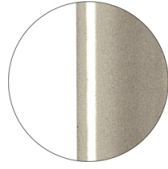

PANTONE 402 C  
VR Turtle-dove

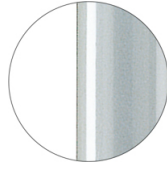

RAL 9006  
VR White aluminium

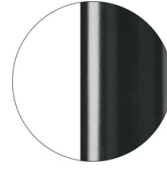

RAL 7016  
VR Anthracite grey

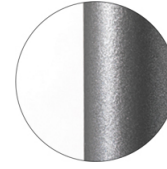

VR Pewter

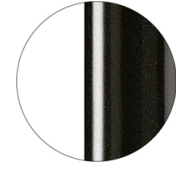

RAL 9005  
VR Jet black

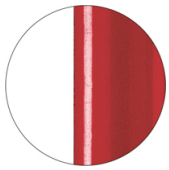

RAL 3003  
VR Ruby red



RAL 8017  
VR Chocolate brown

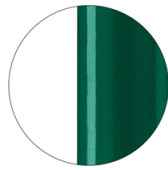

RAL 6005  
VR Moss green

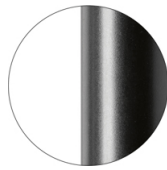

RAL 9005  
VR Matt Jet Black

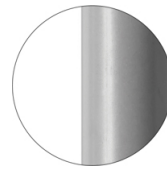

RAL 7037  
VR Matt Dusty grey

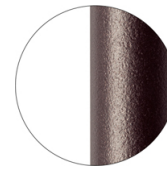

VR Rough metallic  
bronze

## USES

coffee & restaurants, office and waiting areas, outdoor,

## Uni 221

### UNI COLLECTION:

Uni 550, Uni 550M, Uni 378, Uni 378M, Uni 378B, Uni 378B-M, Uni 380, Uni 380M, Uni 380B, Uni 380B-M, Uni 562, Uni 562M, Uni 386, Uni 386M, Uni 602, Uni 602M, Uni 603, Uni 603M, Uni 551M, Uni 551, Uni 552, Uni 552M, Uni 552G, Uni 552M-G, Uni 552T, Uni 552G-T, Uni 558-DP, Uni 558M-DP, Uni 558-DR, Uni 558M-DR, Uni 553, Uni 553M, Uni 577, Uni 577M, Uni 544, Uni 565, Uni 391, Uni 391M, Uni 393, Uni 393M, Uni 220, Uni 221, Uni 222, Uni 223, Trolley 536,

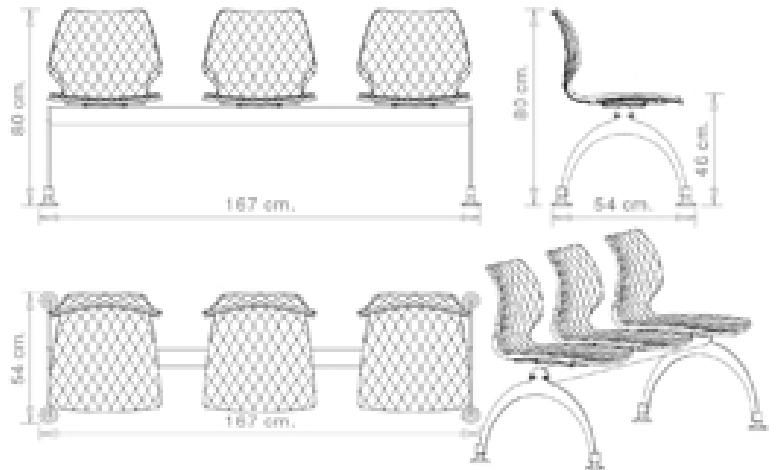

Seating system on bar, 3 seats; steel frame, polypropylene seat.

#### WEIGHT

23 kg

#### PACK

0,89 m<sup>3</sup>

#### PIECES PER BOX

1

### FINISHES SEATING

#### PP POLYPROPYLENE



RAL 9016 Traffic white

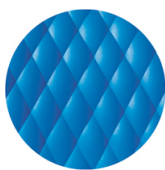

NCS S2060-B Azure



RAL 3000 Flame red



RAL 7016 Anthracite grey



RAL 2003 Pastel orange

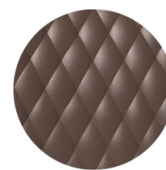

NCS S7005-Y50R Cocoa



RAL 9005 Jet black



RAL 4008 Signal violet



PANTONE 380 C Boss green



NCS S4005-Y50R Turtle-dove



RAL 1004 Golden yellow



PANTONE 18-1438 Marsala

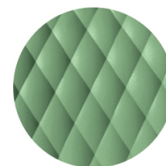

RAL 6021 Pale green

## FRAMES

### AC STEEL



RAL 9016  
VR Traffic white



RAL 9010  
VR Pure white

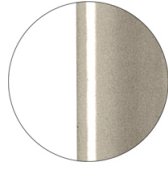

PANTONE 402 C  
VR Turtle-dove

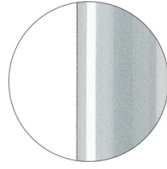

RAL 9006  
VR White aluminium

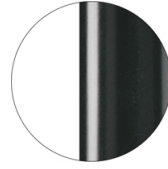

RAL 7016  
VR Anthracite grey

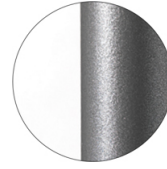

VR Pewter

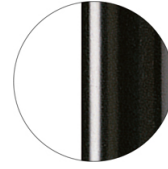

RAL 9005  
VR Jet black

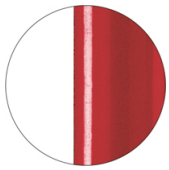

RAL 3003  
VR Ruby red



RAL 8017  
VR Chocolate brown



RAL 6005  
VR Moss green

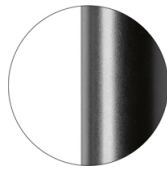

RAL 9005  
VR Matt Jet Black

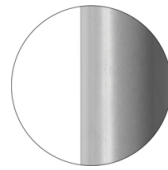

RAL 7037  
VR Matt Dusty grey

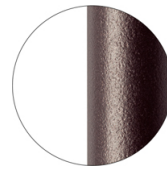

VR Rough metallic  
bronze

## USES

coffee & restaurants, office and waiting areas, outdoor,

## Uni 222

### UNI COLLECTION:

Uni 550, Uni 550M, Uni 378, Uni 378M, Uni 378B, Uni 378B-M, Uni 380, Uni 380M, Uni 380B, Uni 380B-M, Uni 562, Uni 562M, Uni 386, Uni 386M, Uni 602, Uni 602M, Uni 603, Uni 603M, Uni 551M, Uni 551, Uni 552, Uni 552M, Uni 552G, Uni 552M-G, Uni 552T, Uni 552G-T, Uni 558-DP, Uni 558M-DP, Uni 558-DR, Uni 558M-DR, Uni 553, Uni 553M, Uni 577, Uni 577M, Uni 544, Uni 565, Uni 391, Uni 391M, Uni 393, Uni 393M, Uni 220, Uni 221, Uni 222, Uni 223, Trolley 536,

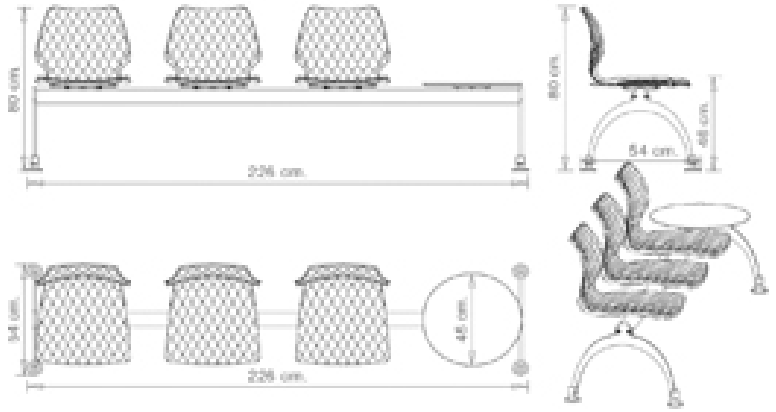

Seating system on bar, 3 seats with shelf; steel frame, polypropylene seat.

#### WEIGHT

29,1 kg

#### PACK

1,25 m<sup>3</sup>

#### PIECES PER BOX

1

### FINISHES SEATING

#### PP POLYPROPYLENE



RAL 9016 Traffic white

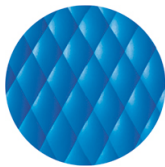

NCS S2060-B Azure



RAL 3000 Flame red



RAL 7016 Anthracite grey



RAL 2003 Pastel orange

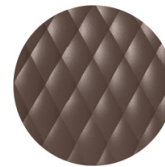

NCS S7005-Y50R Cocoa



RAL 9005 Jet black



RAL 4008 Signal violet



PANTONE 380 C Boss green

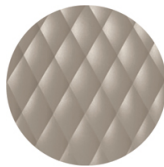

NCS S4005-Y50R Turtle-dove



RAL 1004 Golden yellow

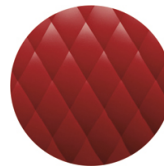

PANTONE 18-1438 Marsala

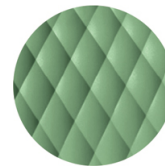

RAL 6021 Pale green

## FRAMES

### AC STEEL



RAL 9016  
VR Traffic white



RAL 9010  
VR Pure white

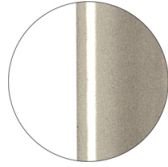

PANTONE 402 C  
VR Turtle-dove

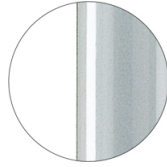

RAL 9006  
VR White aluminium

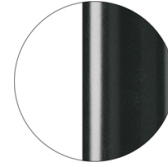

RAL 7016  
VR Anthracite grey

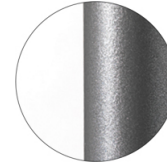

VR Pewter

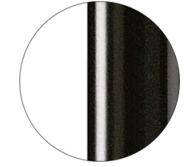

RAL 9005  
VR Jet black

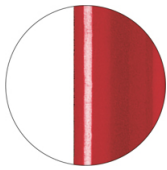

RAL 3003  
VR Ruby red



RAL 8017  
VR Chocolate brown



RAL 6005  
VR Moss green

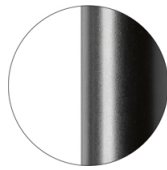

RAL 9005  
VR Matt Jet Black

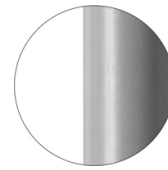

RAL 7037  
VR Matt Dusty grey

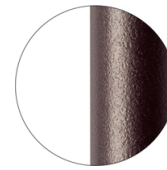

VR Rough metallic  
bronze

## USES

coffee & restaurants, office and waiting areas, outdoor,

## Uni 223

### UNI COLLECTION:

Uni 550, Uni 550M, Uni 378, Uni 378M, Uni 378B, Uni 378B-M, Uni 380, Uni 380M, Uni 380B, Uni 380B-M, Uni 562, Uni 562M, Uni 386, Uni 386M, Uni 602, Uni 602M, Uni 603, Uni 603M, Uni 551M, Uni 551, Uni 552, Uni 552M, Uni 552G, Uni 552M-G, Uni 552T, Uni 552G-T, Uni 558-DP, Uni 558M-DP, Uni 558-DR, Uni 558M-DR, Uni 553, Uni 553M, Uni 577, Uni 577M, Uni 544, Uni 565, Uni 391, Uni 391M, Uni 393, Uni 393M, Uni 220, Uni 221, Uni 222, Uni 223, Trolley 536,

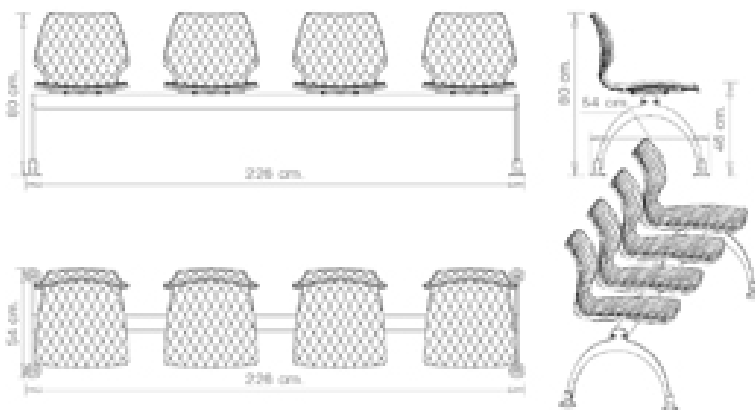

Seating system on bar, 4 seats; steel frame, polypropylene seat.

#### WEIGHT

27,5 kg

#### PACK

1,25 m<sup>3</sup>

#### PIECES PER BOX

1

## FINISHES SEATING

### PP POLYPROPYLENE



RAL 9016 Traffic white

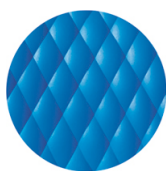

NCS S2060-B Azure



RAL 3000 Flame red



RAL 7016 Anthracite grey



RAL 2003 Pastel orange

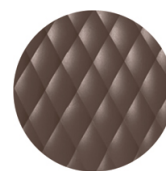

NCS S7005-Y50R Cocoa



RAL 9005 Jet black



RAL 4008 Signal violet



PANTONE 380 C Boss green

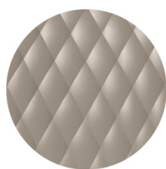

NCS S4005-Y50R Turtle-dove



RAL 1004 Golden yellow



PANTONE 18-1438 Marsala

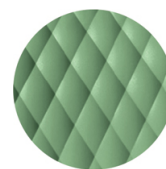

RAL 6021 Pale green

## FRAMES

### AC STEEL



RAL 9016  
VR Traffic white



RAL 9010  
VR Pure white

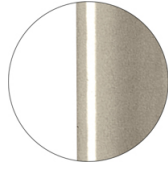

PANTONE 402 C  
VR Turtle-dove

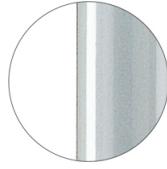

RAL 9006  
VR White aluminium

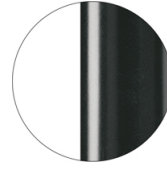

RAL 7016  
VR Anthracite grey

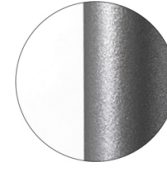

VR Pewter

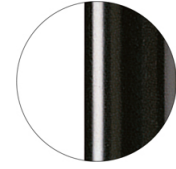

RAL 9005  
VR Jet black

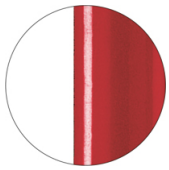

RAL 3003  
VR Ruby red



RAL 8017  
VR Chocolate brown



RAL 6005  
VR Moss green

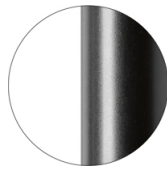

RAL 9005  
VR Matt Jet Black

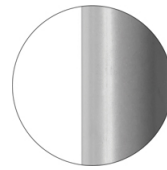

RAL 7037  
VR Matt Dusty grey

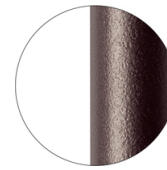

VR Rough metallic  
bronze

## USES

coffee & restaurants, office and waiting areas, outdoor,



## Trolley 536

### UNI COLLECTION:

Uni 550, Uni 550M, Uni 378, Uni 378M, Uni 378B, Uni 378B-M, Uni 380, Uni 380M, Uni 380B, Uni 380B-M, Uni 562, Uni 562M, Uni 386, Uni 386M, Uni 602, Uni 602M, Uni 603, Uni 603M, Uni 551M, Uni 551, Uni 552, Uni 552M, Uni 552G, Uni 552M-G, Uni 552T, Uni 552G-T, Uni 558-DP, Uni 558M-DP, Uni 558-DR, Uni 558M-DR, Uni 553, Uni 553M, Uni 577, Uni 577M, Uni 544, Uni 565, Uni 391, Uni 391M, Uni 393, Uni 393M, Uni 220, Uni 221, Uni 222, Uni 223, Trolley 536,

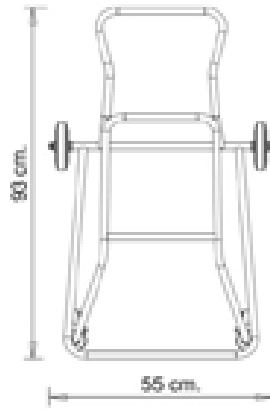
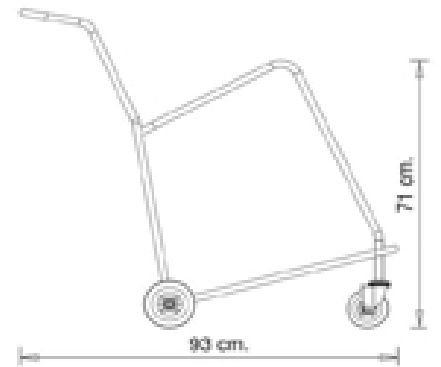
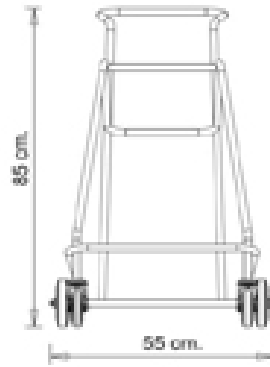

Trolley in black painted steel useful to store and move Uni 550, Uni 580 and Nassau 533 chairs. Equipped with wheels, it can carry up to 10 stackable chairs.

#### WEIGHT

5,8 kg

#### PACK

0,47 m<sup>3</sup>

#### PIECES PER BOX

1

## USES

coffee & restaurants, office and waiting areas, outdoor,