

**ricoma**  
THINK BEYOND

# TC SERIES 7S

Single-Head  
Commercial  
Embroidery  
Machines

+ with intuitive 7"  
high definition true color  
touch screen system



THINK BEYOND

# Single-head solutions

## Technical specifications

Models: RCM-1501TC-7S / RCM-1201TC-7S

Needles: 15 / 12

Heads: 1

Weight: 90 kilograms [200 lbs]

EMB. area: 560mm x 360mm [ 22" x 14" ]

Size: L: 740mm W: 860mm H: 1,575mm

L: 29" W: 34" H: 62"

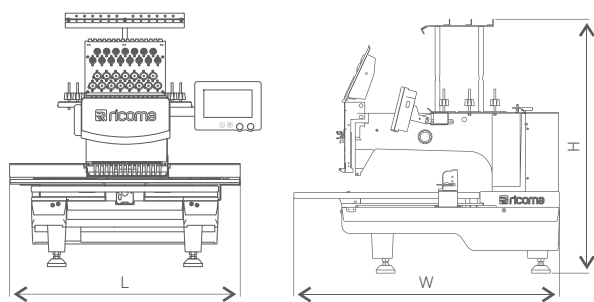

L: 740mm W: 860mm H: 1,575mm [L: 29" W: 34" H: 62"]

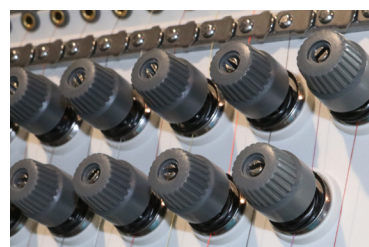

Thread Break Detection



Automatic Color Change



7" User-Friendly Touch Panel



270° Wide Angle Cap System

## Main features

- Suitable for embroidery on flats, caps, finished garments and more!
- Perfect for established or home businesses
- High Definition True Color 7" LCD Touch Screen
- Maximum embroidery area: 560mm x 360mm, or 22" x 14"
- Light weight – only 90 kilograms (200 lbs) for easy maneuverability
- Heavy duty steel stand with wheels to ensure both stability and mobility
- Thread break detection
- Maximum speed: 1200 SPM
- Memory capacity: 20 million stitches or 200 designs
- External 100° button and trimming button
- Automatic thread trimmer

Suited for all embroidery types



- Machine reads multiple design formats, such as DST, DSB and more
- 270° wide angle cap system
- Environmentally friendly packaging
- USB input or direct transmission from PC via LAN port or wireless
- Networkable and Wi-Fi capable
- Automatic color change
- Pre-sewn design trace capable
- Servo motor 150W – lowest power consumption in the industry!
- Built-in universal power supply, 110V/60Hz and 200V/50Hz self-adaptable worldwide
- DC36V micro-step motor for X & Y axis driving to ensure low noise and less vibration
- Easily add appliqué, sequin, boring or cording
- Built-in button from 172° to 196° under manual color change mode, a great help for machine maintenance
- Frame offset and frame outlining available for easy appliqué embroidery
- Multi-angle, rotatable and adjustable control panel bracket allows for better visibility
- Recessed USB port to protect USB flash drive
- One-step trace button directly on main screen
- Optional laser trace device available
- Emergency stop button
- Multiple hoop sizes for variety of embroidery needs
- Automatic memory retention
- Multiple languages: English, Chinese, Spanish, Portuguese, Turkish, Dutch, French, German, Russian, Vietnamese, Thai, Arabic and more

---

Intelligent technology

---



---

High speed with high efficiency

---

Favorited among startups

# High Def True Color 7" LCD

Technical specifications

## High Definition True Color 7" LCD Touch Screen

The intuitive High Definition True Color 7" LCD Touch Screen displays a clean interface with easy one-step commands for simple operation and a pleasant user experience.

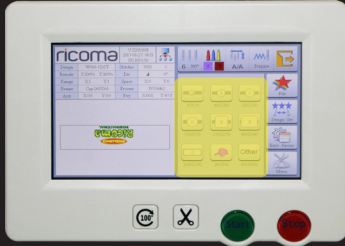

Preset hoops

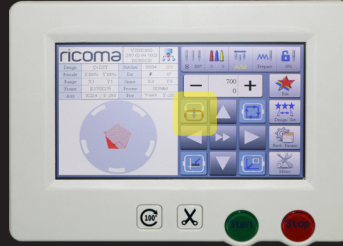

One-step appliqué



Easy color selection



On-board lettering

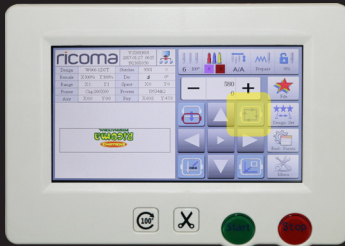

One-step tracing



Easy design selection

## Panel features

- User-friendly interface
- Easy to operate
- Easily add appliqué, sequin, boring or cording
- New ergonomic touch screen allows easy and comfortable operation by right hand thumb
- Preset hoop parameters, which are designed to avoid hitting hoop frames
- Automatic color change

---

User-friendly interface

---



- Built-in button from 172° to 196° under manual color change mode, a great help for machine maintenance
- Frame offset/frame outlining available for easy appliqué embroidery
- Multi-angle, rotatable and adjustable control panel bracket allows for better visibility
- Pre-sewn design trace capable
- One-step trace button directly on main screen
- External 100° button and trimming button
- Automatic thread trimmer
- USB input or direct transmission from PC via LAN port or wireless
- Networkable and Wi-Fi capable
- Thread break detection
- Multiple languages: English, Chinese, Spanish, Portuguese, Turkish, Dutch, French, German, Russian, Vietnamese, Thai, Arabic and more

---

Better visibility

---

---

Ergonomic design

---

User-friendly interface allows user to complete more projects faster.

Endless capabilities

# Hoops and cap attachments included

11 hoops of different sizes

	(x2)	90 mm round [9 cm, 3.5"]
	(x2)	120 mm round [12 cm, 4.7"]
	(x2)	150 mm round [5 cm, 5.9"]
	(x2)	200 mm round [20 cm, 9"]
	(x2)	290 x 290 mm square [29 cm, 12"]
	(x1)	540 x 350 mm oval [54 x 35 cm, 21 x 14"]

The TC Series is perfect for embroidery on caps, bags, denim, finished garments and plenty more! Each TC comes equipped with 11 hoops of different sizes , a cap driver, 2 cap rings and a hoop station to fill all embroidery needs.

Capable of embroidering caps, shirts, pants and much more!



Embroider any cap with ease with our cap system that comes with all machines!



#### Cap attachments included

<b>Cap rings</b>	[x2] Cap rings snap into hoop station to prepare machine for cap embroidery
<b>Hoop station</b>	[x1] Hoop station provides stability for fast and easy cap hooping
<b>Cap driver</b>	[x1] Cap driver snaps into embroidery machine's bracket holder for hoops

Embroider any cap with ease with the machine's 270-degree wide angle cap system. Each TC Series is suitable for cap embroidery and includes all the necessary cap attachments to get started.



Cap ring



Hoop station

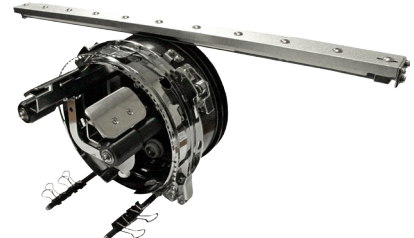

Cap driver

# Network capability ready

## Flexible production system

Using advanced network technology, users can link together as many Ricoma TC Series as desired to create an extremely flexible production system. Embroider the same design on all of your machines at the same time or embroider different designs on individual machines simultaneously.

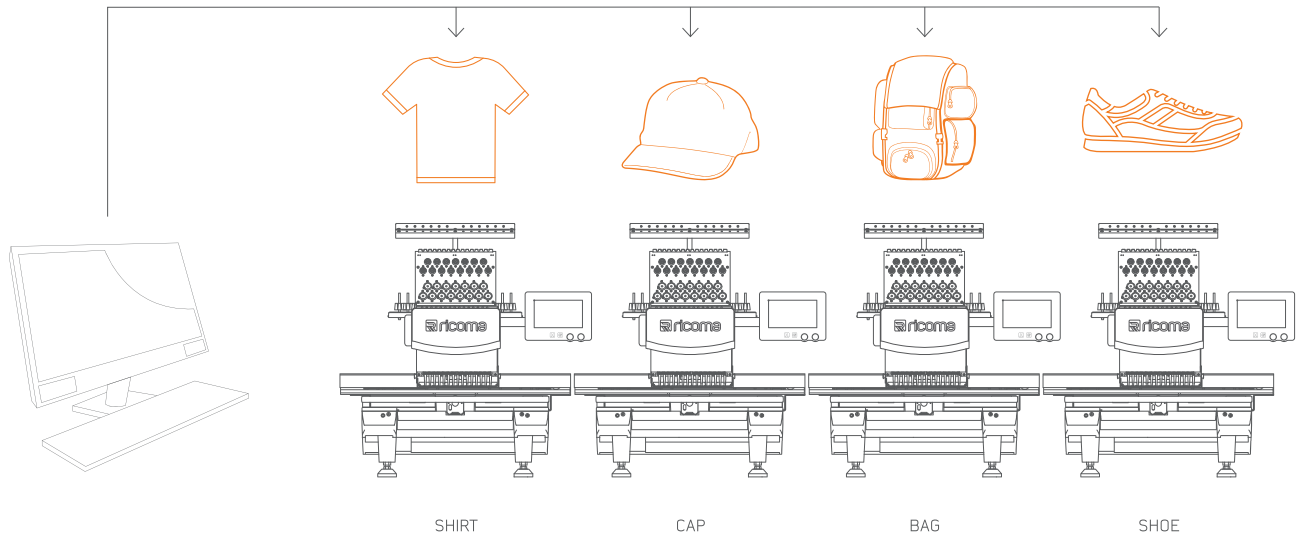



# Startup package

Equipped with all the attachments to get started right away

Our TC Series is ideal for commercial embroidery on caps, bags, denim, finished garments and plenty more. Equipped with all the necessary attachments to get started, the TC is ideal for startups or established apparel businesses that want to add or expand their embroidery capabilities.



### Heavy duty steel stand

Each TC includes a heavy duty steel stand to support the machine. The stand's wheels assist with mobility and portability.



### High Definition True Color 7" LCD Touch Screen + Panel

The modern touch screen interface and ergonomic panel allow for a user-friendly experience.



### Wilcom DecoStudio E3 Lite

Perfect for digitizing beginners, this software allows users to customize pre-digitized designs or create simple, custom designs from scratch.



### Amann starter kit

Each starter kit comes with 20 spools of 100% polyester thread, two spools of metallic thread, a 144-piece box of pre-wound bobbins, two needles and four types of backing.

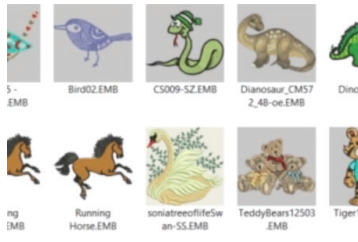

### 20,000 stock designs

Each machine comes with 20,000 digitized stock designs to get you started! Pair with Wilcom DecoStudio Lite to create one-of-a-kind designs!

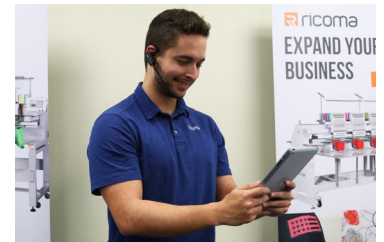

### Training and Support

Ricoma provides free hands-on training with the purchase of any embroidery machine. Our customer support is available 7 days a week and after hours.

\*The above-mentioned items are included in the startup package only when purchased directly from our U.S. Headquarters - Ricoma International Corporation.

# Optional add-ons

Broaden your possibilities with these affordable and easy-to-use add-ons!

These attachments make hooping and adding embroidery effects a breeze. Embellish your designs with sequins, boring or cording; or use specialty hoops for all embroidery needs.



## Sequin device

Attach the optional sequin device to your embroidery machine for a pop of sparkle to your embroidery and a quick and easy fill.



## Boring device

This device punctures holes into embroidered designs and encloses the raw edges with stitches to create a beautiful effect within minutes.

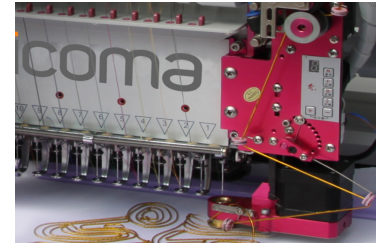

## Cording device

Easily create an embroidery effect with the cording device, which lays cord on fabric and attaches the cord with transparent zigzag stitches.



## 8-in-1 device

Designed for non-hoopable, difficult items such as shirt pockets, socks, backs of caps, shirt sleeves, collar tips and more.



## Robot frame

Embroider on difficult-to-embroider and unusually shaped items such as bags, pockets, shoes and purses with the robot frame.

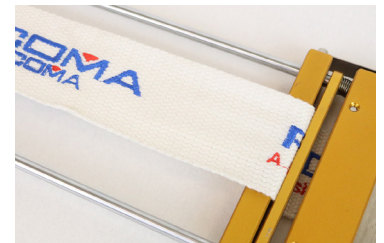

## Belt hoop

With an 8-inch x 4-inch embroidery area, the belt hoop allows ample room for embroidery on belts and straps.

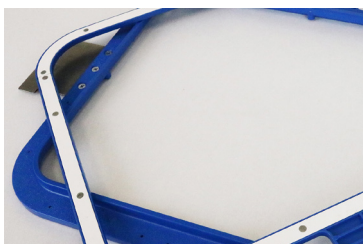

## Mighty hoop

With a wide variety of hoop sizes to choose from, these magnetic hoops make hooping all types of differently sized garments a breeze.

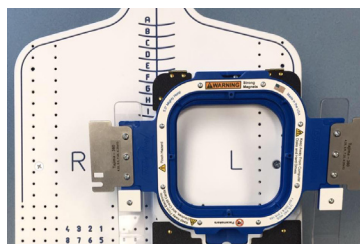

## HoopMaster

The easiest to use embroidery hooping aid on the market, the HoopMaster is custom-made for your hoops, so there is no hardware to adjust.



## Laser device

With this easy-to-install tracing tool, there's no more hitting hoops – just simply watch the laser pointer trace the design in seconds.

# Optional extended embroidery area

Extended Table EW-4814 and Extended Table EW-2214

The extended table is the perfect aide for embroidery on oversized items such as drapery, blankets, banners, mattress borders, wedding dresses, quilt covers and much more. \*Available for all single-head machines.

## Models:

Extra large embroidery area 122 x 35 cm (48" x 14") and Sash Frame

Extended tabletop 56 x 35 cm (22" x 14") and Sash Frame

Extended Table EW-4814





THINK BEYOND

---

**Ricoma Headquarters in USA**

**Ricoma International Corporation**

3450 NW 114th Ave., Miami, FL 33178, USA

TEL: [305] 418-4421 | FAX: [305] 418-5036

Toll Free: 1-888-292-6282

Website: [www.ricoma.us](http://www.ricoma.us) | Email: [info@ricoma.us](mailto:info@ricoma.us)

**Ricoma Factory in China**

**Ricoma (Shenzhen) Co., Ltd.**

Baochangli Industrial Park, Jinlong Road 3,

Shenzhen, P.R. China [Post: 518118]

TEL: +86-755-2585-7576 | FAX: +86-755-2585-7773

Website: [www.ricoma.cn](http://www.ricoma.cn) | Email: [info@ricoma.cn](mailto:info@ricoma.cn)