



# AirCycler<sup>®</sup> g2-k Training Guide

VENTILATION MADE BREEZY!<sup>™</sup>  
a breeze to install • a breeze to use

# TABLE OF CONTENTS

## AirCycler® g2-k Introduction

### Safety Considerations

### Installation Considerations

### AirCycler® g2 Controller Location

### Damper Location & Damper Installation

### Choose a Fresh Air Location

### Battery (Model CR1220)

## AirCycler® g2-k Wiring

## FanConnect™ Switch Wiring (Optional)

### 1.0 Theory of Operation

#### 1.1 Operation Details

#### 1.2 Operation Examples

### 2.0 AirCycler® g2 Operation

#### 2.1 Reading the AirCycler® g2

#### 2.2 Normal Operation Display

#### 2.3 Entering Setup Mode

### 3.0 Setup Options

### 4.0 Calculated Flow Set Up

#### 4.1 Setting Measured Supply Air Flow

#### 4.2 Setting Measured Exhaust Air Flow

#### 4.3 Setting Code Required Constant Air Flow

#### 4.4 Setting Optional Mixing Time

#### 4.5 Setting Operation Hours

#### 4.6 Setting Exhaust Fan Delay Time

### 5.0 Calculated Time Set Up

#### 5.1 Setting Number of Minutes Per Hour of Supplied Air Flow

#### 5.2 Setting Minutes of Exhaust Fan Run Time Required

#### 5.3 Setting Optional Mixing Time

#### 5.4 Setting Operation Hours

#### 5.5 Setting Current Time

#### 5.6 Setting Exhaust Fan Delay Time

### 6.0 Viewing Current Status & Settings

#### 6.0 Current Status

#### 6.1 Current Settings

#### 6.2 Setting Current Time

#### 6.3 Reset to Default Values

### 7.0 Installation Testing Guide

## Appendix A: Troubleshooting & Tips

## Appendix B: ASHRAE 62.2 Reference Chart



## SAFETY CONSIDERATIONS

Read and follow manufacturer's instructions carefully. Follow all local electrical codes during installation. All wiring must conform to local and national electrical codes. Improper wiring or installation may result in personal injury or product and property damage.

## INSTALLATION CONSIDERATIONS

The AirCycler® g2 requires 24VAC (R and C terminals) to be connected for proper operation. The controller will not operate without these two connections.

The wires (R, C, & W ) from the air handler to the thermostat can run parallel with the wiring from the AirCycler® g2 to the air handler. The fan wire (G) must be interrupted by the AirCycler® g2. Some thermostats do not require a common (C) connection. The AirCycler® g2 requires this for power, which must be wired to the furnace.

## AIRCYCLER® g2 CONTROLLER LOCATION

The AirCycler® g2 controller can be installed near the thermostat or out of view on/near the air handler unit. See the wiring diagram on page 4.

*Warning: Before installing the AirCycler®, turn off all power to the furnace. There may be more than one power to disconnect. Electrical shock can cause injury or death.*

## DAMPER LOCATION

The fresh air damper can be located anywhere in the inlet duct. Minimize the length of the inlet duct to improve air flow and improve system efficiency. It is recommended that the damper be as close to the return air plenum and the AirCycler® g2 controller as possible, and the inlet duct connect to the return plenum upstream of the system filter, and down-stream of any duct mounted sensors.

## DAMPER INSTALLATION

The damper may be installed in any position. It is recommended to install it with the motor at the 12 o'clock position if mounted horizontally. Air may flow through in either direction, although it is recommended to install with the crimped end as the outlet. Use care to avoid distorting the damper housing and provide adequate support. **Upon system start up be sure to set damper power switch to UP or AUTOMATIC position.**

## CHOOSE A FRESH AIR LOCATION

ASHRAE recommends that the fresh air intake be located at least 10 ft. from any source of pollutants, such as auto exhaust, dryer exhaust, exhaust from any fuel-burning appliances, etc. Avoid installation near odor sources such as garbage bins or barbecue grills. A minimum of 3 ft. above ground is recommended to avoiding ingress of leaf litter, grass clippings, etc. Do not use a crawl space, basement, or attic as a source of intake air. Always be sure to comply with local building codes and requirements regarding fresh air inlets.

## BATTERY (MODEL CR1220)

The AirCycler® g2 is equipped with a real time battery backed-up clock for use with the Operation Hours setting ONLY. If not setting the hours of operation, the included battery is not required. All other settings are saved in nonvolatile memory.

**RECORD ALL SETTINGS ON THE INSTALL STICKER PROVIDED. LIMITED WARRANTY WILL BE VOID IF THE STICKER IS NOT PRESENT.**

# AIRCYCLER® G2-K WIRING

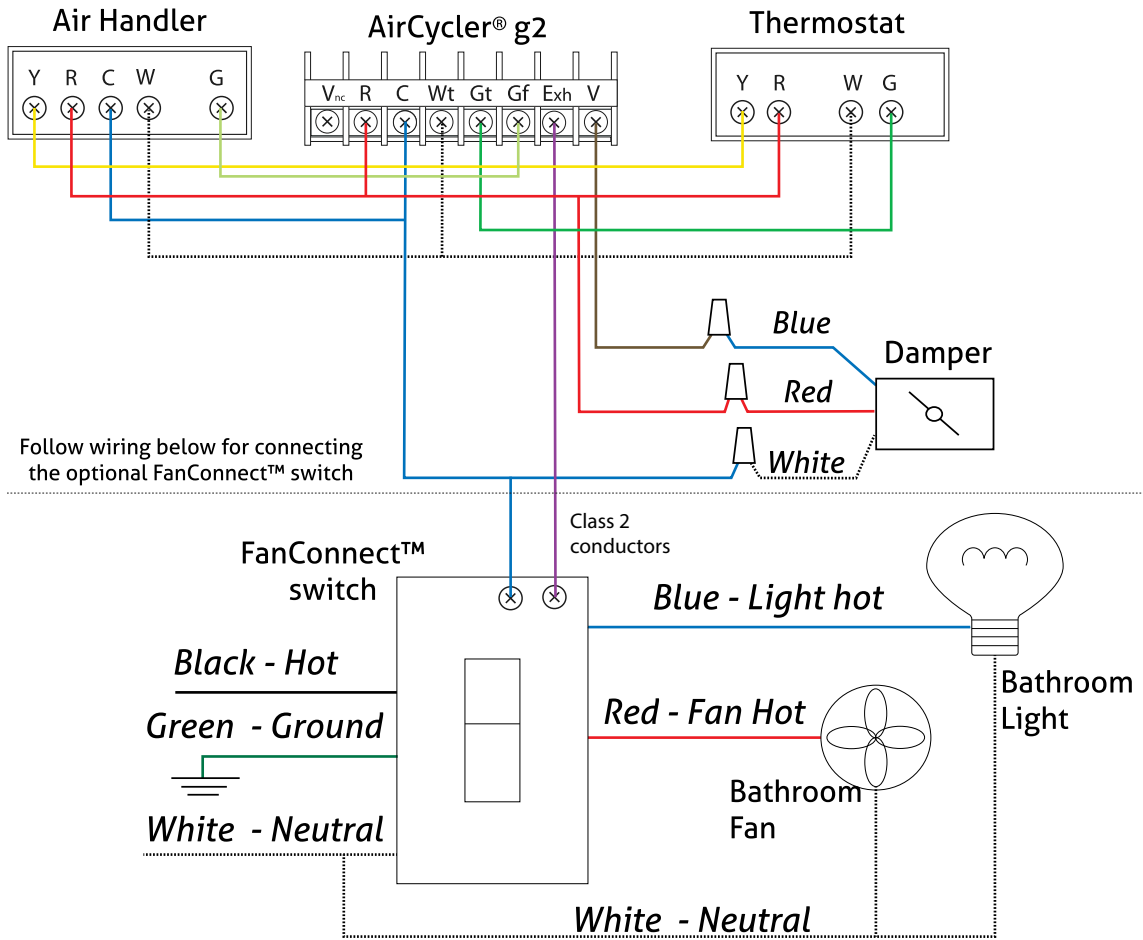

KEY	
R	24VAC Power
C	Common
W	Heating
Gt	Fan From Thermostat
Gf	Fan To Furnace
V	Vent
Ex	Exhaust Fan
Vnc	Normal Closed Vent (To power spring-return dampers that are normally open)

# FANCONNECT™ SWITCH WIRING (OPTIONAL)

## INTRODUCTION

Power for the g2 controller, damper and FanConnect™ switch comes from the 24VAC supply in the furnace.

The damper draws only 35mA during the 15 seconds it takes to open or close.

The relay in the FanConnect™ switch draws 100mA when the controller is activating the bath fan.

All can be wired with standard 18-22awg 600V thermostat wire.

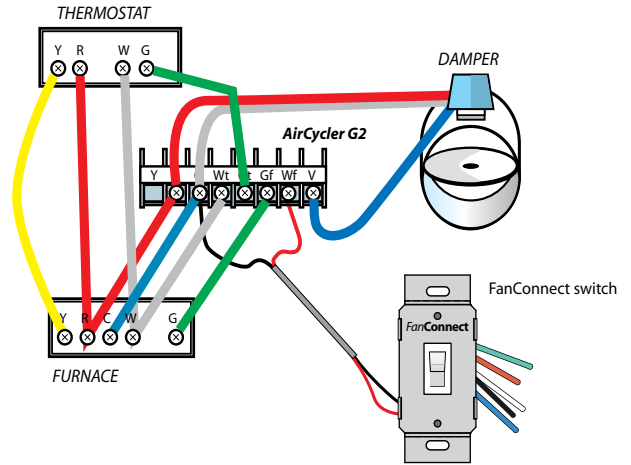

## WIRING

The switch requires an always hot 110VAC feed. (Black wire & White neutral wire)

The Blue 110VAC switch leg (load) powers the light circuit. It is a simple mechanical contact within the toggle switch. It can handle up to 450 Watts.

The Red 110VAC switch leg (load) powers the fan. This is also a mechanical contact within the internal relay. It can handle up to 150 Watts. Works fine with DC fans.

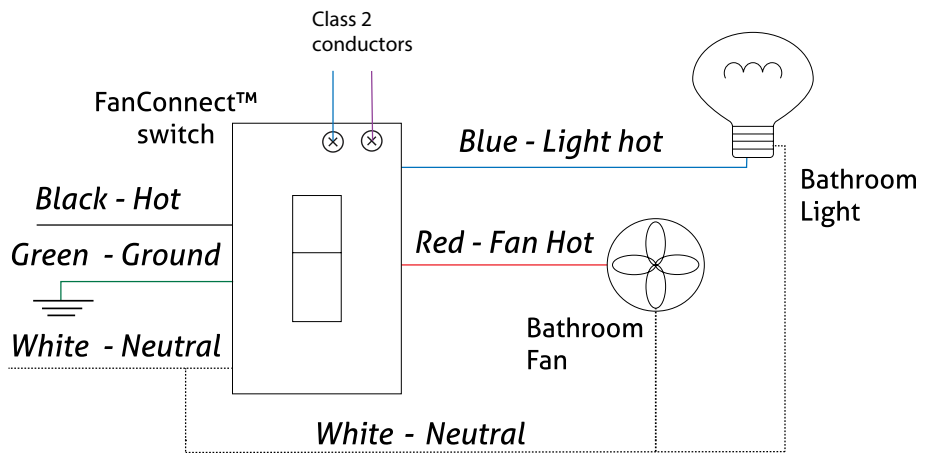

## INSIDE THE FANCONNECT™ SWITCH

Inside the FanConnect™ switch is a 24VAC relay to control the 110VAC bath fan.

Anytime the light switch is turned on, the fan circuit is energized supplying power to the fan.

The AirCycler® g2 controller can:

- Read when the bath fan is on and track that time.
- Turn fan on for a delay time after bathroom is used.
- Turn fan on for a programmed amount of time every hour to meet ventilation requirements.

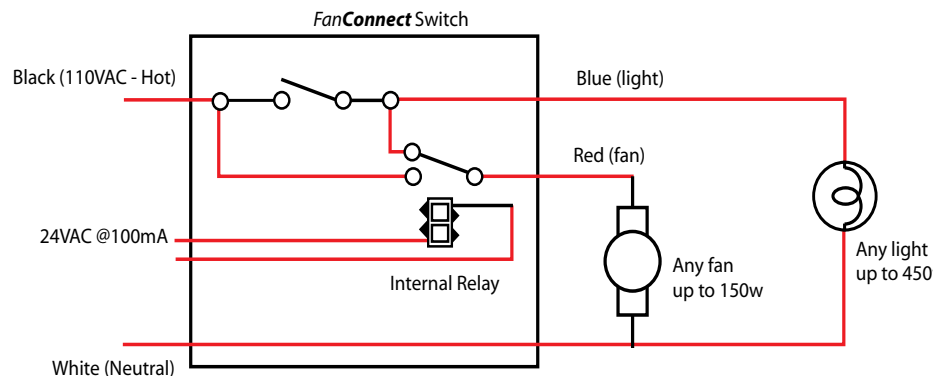

3191003  
CONFORMS TO UL  
STD. 917

Clock-Operated Switches (UL 917 5th Ed., Rev. October 7, 2009) & Clock-Operated Switches (CAN/CSA C22.2 No. 177-92, Rev. October, 2000)

# 1.0 THEORY OF OPERATION

## 1.1 OPERATION DETAILS

The AirCycler® g2 Furnace Fan Timer is integrated with the home's central furnace fan so that any time the central fan is turned on by the thermostat to provide heating or cooling, the AirCycler® g2 opens the motorized damper to let in a measured amount of fresh air. The fresh air is then distributed uniformly throughout the home through the existing ductwork.

When ventilation requirements are met, the damper is closed to prevent over-ventilation.

Should regular heating and cooling cycles not run long enough to meet the desired or required ventilation, the AirCycler® g2 can turn on the smaller and more economical bathroom exhaust fan (or other exhaust fan) through the optional FanConnect™ Switch.

With no need to run the large central fan to provide additional ventilation, homeowner complaints of cold air or noisy operation are eliminated and efficiency is drastically improved.

## 1.2 OPERATION EXAMPLES

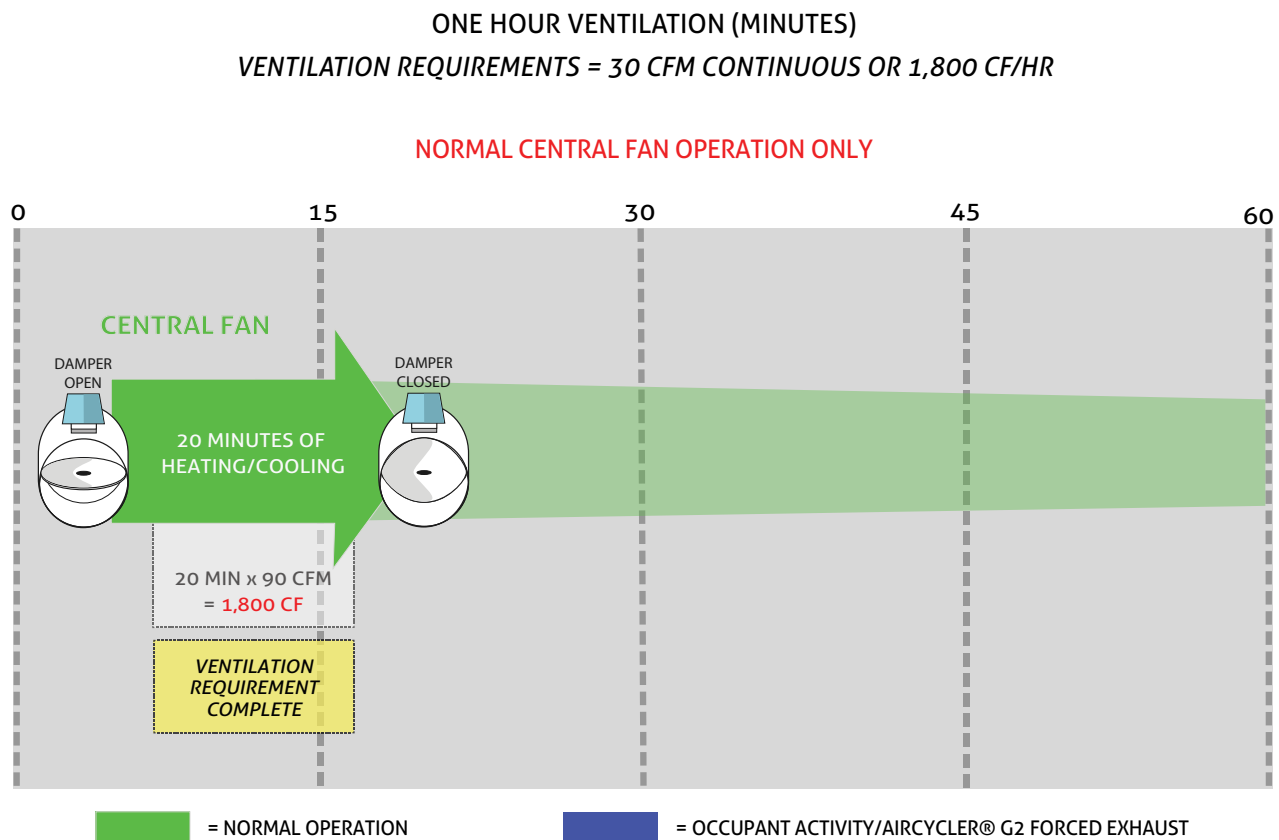

Enough ventilation took place during normal heating/cooling cycles to meet ventilation requirements for the hour.  
No need for additional ventilation forced by AirCycler® g2.



## 1.2 OPERATION EXAMPLES CONT'D

ONE HOUR VENTILATION (MINUTES)  
 VENTILATION REQUIREMENTS = 30 CFM CONTINUOUS OR 1,800 CF/HR  
 NORMAL CENTRAL FAN OPERATION + AIRCYCLER® G2 FORCED EXHAUST

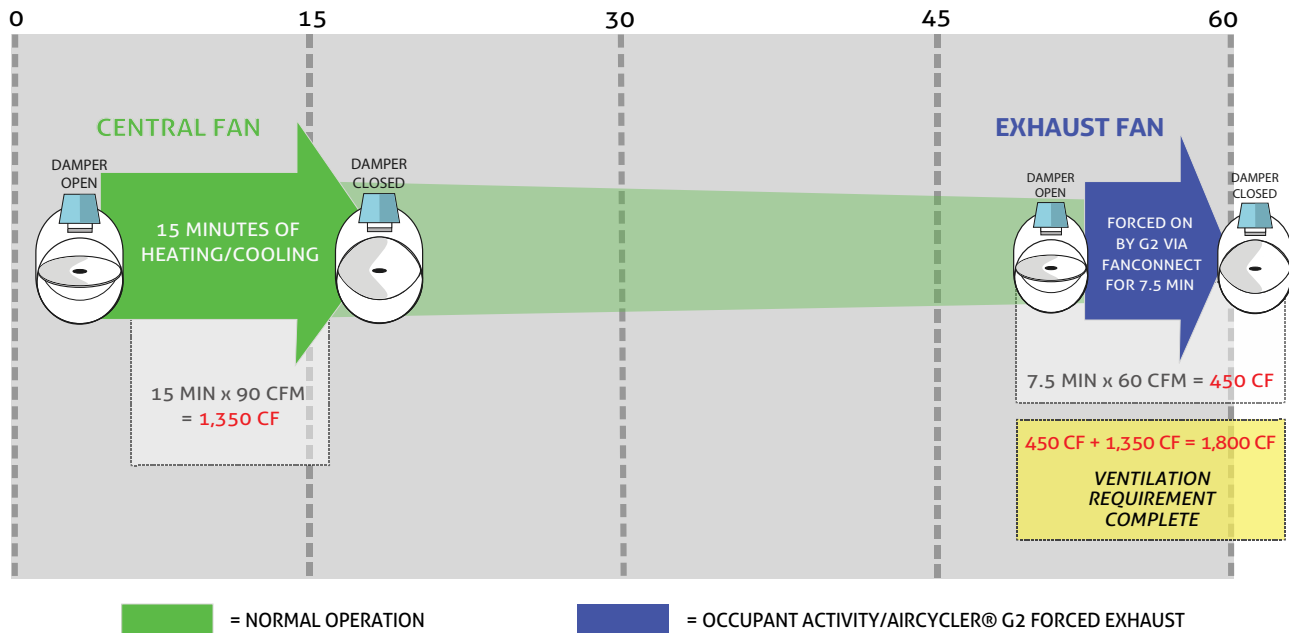

After regular heating/cooling cycles, ventilation requirements for the hour were not met. At the end of the hour the AirCycler® g2 forced on the bathroom exhaust fan, via the FanConnect™ switch, to reach required ventilation.

### NORMAL CENTRAL FAN OPERATION + OCCUPANT EXHAUST USE

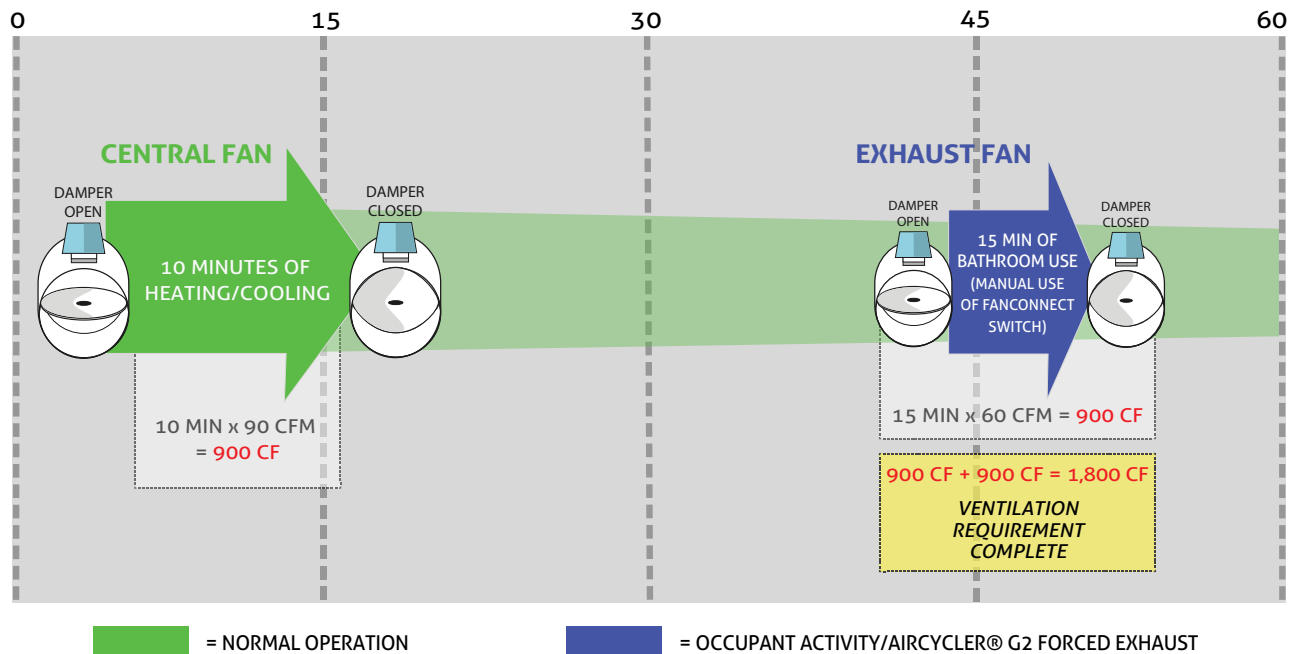

After regular heating/cooling cycles and manual occupant use of bathroom exhaust fan, ventilation requirements for the hour were met. No need for additional ventilation forced by AirCycler® g2.

## 1.2 OPERATION EXAMPLES CONT'D

ONE HOUR VENTILATION (MINUTES)  
 VENTILATION REQUIREMENTS = 30 CFM CONTINUOUS OR 1,800 CF/HR

NORMAL CENTRAL FAN OPERATION + OCCUPANT EXHAUST USE + AIRCYCLER® G2 FORCED EXHAUST

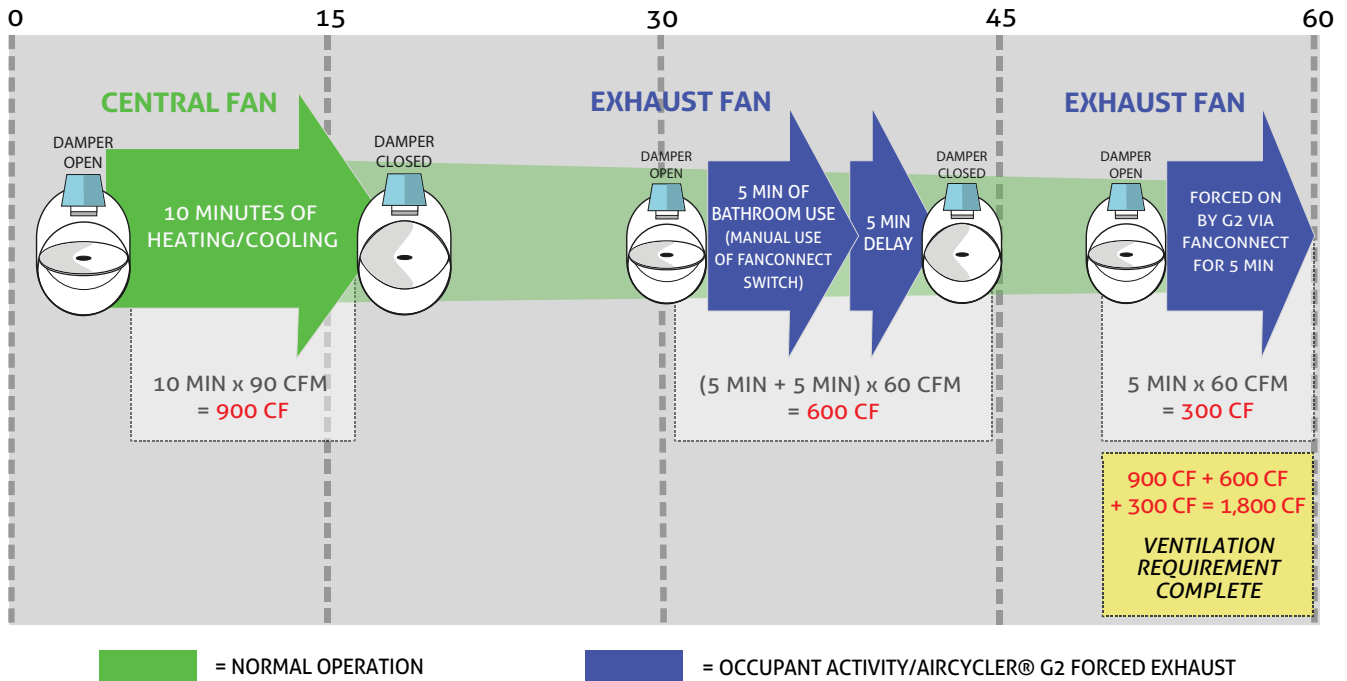

After regular heating/cooling cycles and manual occupant use of bathroom exhaust fan (including 5 minute delay), there was not enough ventilation to meet requirements for the hour. At the end of the hour the AirCycler® g2 forced on the bathroom exhaust fan, via the FanConnect™ switch, to reach required ventilation.

## 2.0 AIRCYCLER® G2 OPERATION

### 2.1 READING THE AIRCYCLER® G2

G2 DISPLAY KEY		
OPERATION	OA	Damper Open
	EXH	Exhaust Fan On
	FAN	Central Fan On
	ON	G2 Operation On (Forcing Central Fan On)
	%	Percent Ventilate Complete for Hour
SETUP/STATUS	CFM	Air Flow Cubic Feet Per Minute Values
	SET	Setup Mode
	REQ	Required CFM Setting
	TIME	Time Setting Mode
	HR	Hour
	MIN	Minutes
	AM	Time - AM
	PM	Time - PM



FUNCTIONS APPLY WHEN ICONS ARE ACTIVE/ILLUMINATED

### 2.2 NORMAL OPERATION DISPLAY

LCD DISPLAY

- Normal display will show the percentage of the current ventilation cycle (hour) that is complete.
- If the central fan is running from a thermostat call, the FAN icon will show.
- If the AirCycler® g2 has forced on the central fan, the FAN and ON icons will show.
- If the exhaust (bath) fan is on, the EXH icon will show.
- If the outside fresh air damper is open the OA icon will show.

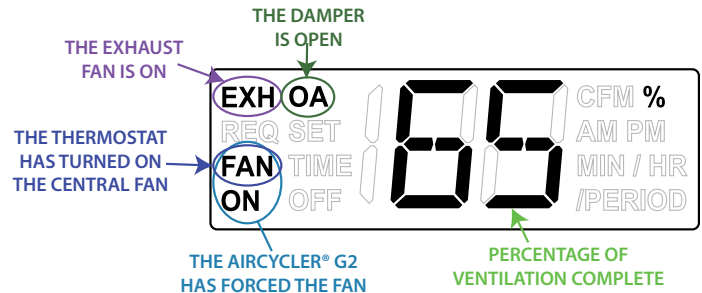

If the EXH fan is running its set delay time after the FanConnect™ has been turned off, the delay time countdown as well as the MIN and EXH icons will show.

### 2.3 ENTERING SETUP MODE

Once wiring is complete, place the controller on the base. All icons will be illuminated for 3 seconds.

Press the UP arrow within 3 seconds of power up to enter **Calculated Flow Setup**

Press the DOWN arrow within 3 seconds of power up to enter **Calculated Time Setup**

If a set up method was not selected within 3 seconds, remove controller from base and replace to re-enter setup mode.

### 3.0 Setup Options

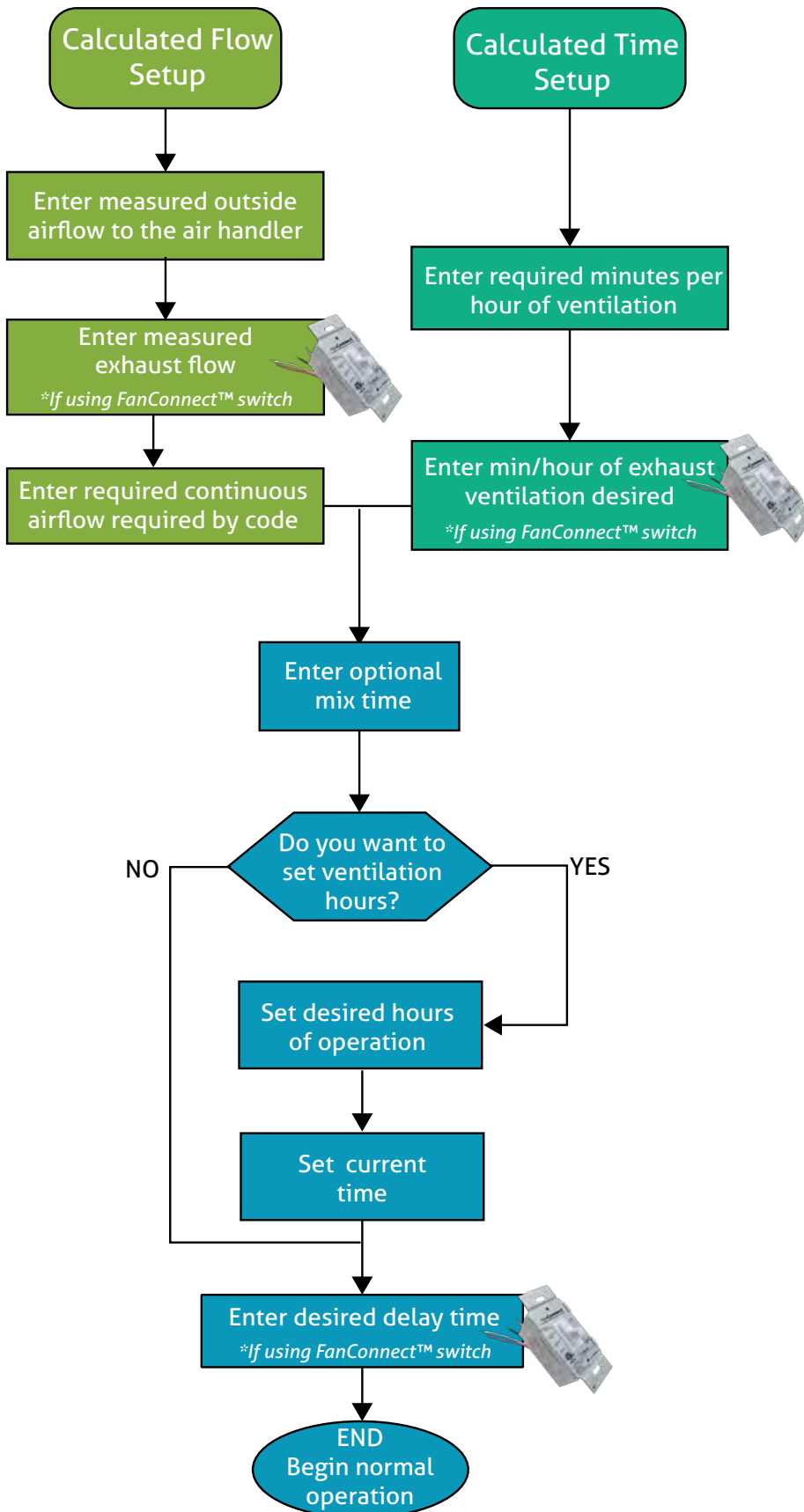

#### Calculated Flow

If you know the amount of fresh air that goes into the air handler as well as the flow required by code, you can simply enter them into the AirCycler® g2 controller during set up.

#### Calculated Time

If you'd prefer to configure the amount of time you want fresh air ventilation per hour, you can enter the total minutes per hour into the AirCycler® g2 during set up.

## 4.0 CALCULATED FLOW SET UP

### 4.1 SETTING MEASURED SUPPLY AIR FLOW

The measured flow is the amount of air that enters the return side of the air handler from the outside air vent. Enter the measured flow. To accommodate variable speed air handlers, you can enter different values for heat, cool and fan. Factory default is 90 CFM.

Press MODE to advance to the next setting.

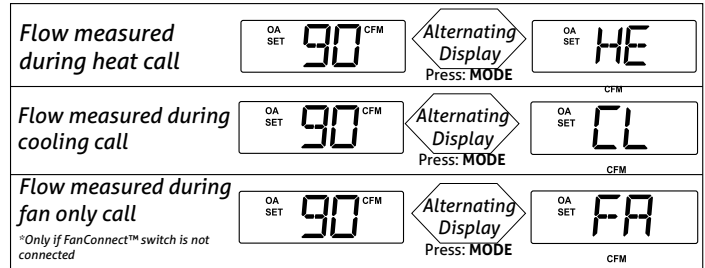

### 4.2 SETTING MEASURED EXHAUST AIR FLOW

Enter the measured flow from the exhaust fan. Factory default is 60 CFM. *If the FanConnect™ switch is not detected, make sure it is in the OFF position*

Press MODE to advance to the next setting.



### 4.3 SETTING CODE REQUIRED CONSTANT AIR FLOW

Set the required continuous air flow in CFM based on relevant codes. For ASHRAE 62.2 see Appendix B. Factory default is 30 CFM. The AirCycler® g2 will calculate run times based on settings 4.1 and 4.2.

Press MODE to advance to the next setting



### 4.4 SETTING THE OPTIONAL MIXING TIME

If the user needs more central fan time for whole house mixing than the amount that is provided by ventilation time, the central fan can be configured to run an additional time period to complete the mixing period. Factory default is 0 or OFF. The fresh air damper will not be open during this extra time.

Press MODE to advance to next setting.

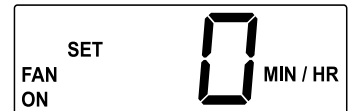

### 4.5 SETTING OPERATION HOURS

If the user does not want the ventilation system to run constantly, you can set ON time and OFF time. Factory default is NO. **See Section 5.4 for setup.**

Press MODE to advance to the next setting.



### 4.6 SETTING EXHAUST FAN DELAY TIME

Set the desired length of time you want the exhaust fan to run after the FanConnect™ switch has been turned off. Factory default is 10 minutes.

Press MODE to save all settings and return to normal operation.



## CALCULATED FLOW SETUP IS COMPLETE

The AirCycler® g2 will now return to normal operation OR continue pressing MODE for Optional Mixing Time, Operation Hours, and Exhaust Fan Delay Time Settings. See Sections 5.3-5.6 for details.

## 5.0 CALCULATED TIME SETUP

### 5.1 SETTING NUMBER OF MINUTES PER HOUR OF SUPPLIED AIR FLOW REQUIRED

Enter the minutes per hour that you require fresh air to be brought into the home. Factory default is 20 minutes. Press MODE to advance to the next setting.

For installations without the FanConnect™ switch, continue to section 5.4.



### 5.2 SETTING MINUTES OF EXHAUST FAN RUN TIME REQUIRED

Enter the desired minutes/hour for exhaust fan run time. Factory default is 20 minutes. If the FanConnect™ switch is not detected, make sure it is in the OFF position. Press MODE.



### 5.3 SETTING OPTIONAL MIXING TIME

If the user needs more central fan time for whole house mixing than the amount that is provided by ventilation time, the central fan can be configured to run an additional time period to complete the mixing period. Factory default is 0 or OFF. The fresh air damper will not be open during this extra time. Press MODE to advance to the next setting.

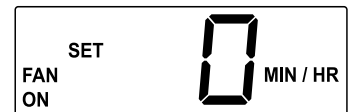

### 5.4 SETTING OPERATION HOURS

If the user does not want the ventilation system to run constantly, you can set ON time and OFF time. Factory default is off.

If you are not setting an ON and OFF time, press MODE and continue to section 5.6.

If you select YES, the AirCycler® g2 will prompt you to enter the hour you would like the ventilation to begin and the hour you want it to end followed by the current time.

Set the hour for ventilation to START. Press MODE to advance to the next setting.

Set the hour for ventilation to STOP. Press MODE to advance to the next setting.



### 5.5 SETTING CURRENT TIME

Enter the current time. Press MODE to advance to the next setting.

If you are not connecting a FanConnect™ switch, Press MODE until Normal Operation is resumed. CALCULATED TIME SETUP IS COMPLETE

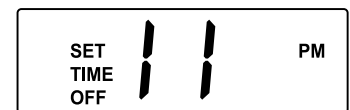

### 5.6 SETTING EXHAUST FAN DELAY TIME

Set the desired length of time you would like the bath fan to run after the FanConnect™ has been turned off. Factory default is 10 minutes.

Press the DOWN arrow until the countdown reaches 0 then SL (SL= slave mode). In slave mode the exhaust fan runs anytime the central fan is running with the fresh air damper open. Slave mode will provide a "balanced" mode of operation.

Press MODE to save all settings and return to normal operation.

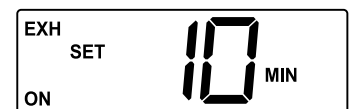

**CALCULATED TIME SETUP IS COMPLETE.** The AirCycler® g2 will now return to normal operation.

## 6.0 CURRENT STATUS & SETTINGS

To get detailed information on the current status of the AirCycler® g2, press the UP arrow. The status screens are the same for both Calculated Flow and Calculated Time modes. Press the UP arrow to advance to each setting.

To view the current settings, press the DOWN arrow during Normal Operation. Press the DOWN arrow to advance to each setting.

Pressing the MODE button will take you to current time settings.

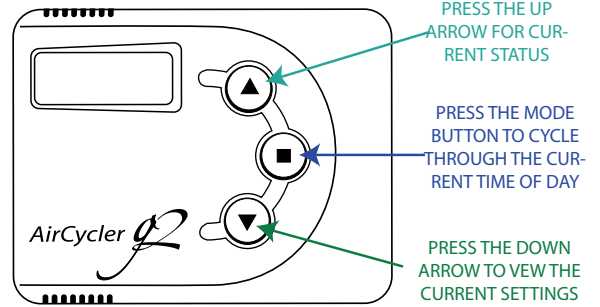

### 6.0 CURRENT STATUS

#### MINUTES LEFT

The first display is the number of minutes left in the period (hour).



#### OUTSIDE AIR TIME ELAPSED

This display shows the number of minutes this period that the outside air damper has been open with the central fan running.

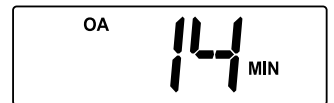

#### EXHAUST RUN TIME (If using FanConnect™ switch)

This shows the elapsed run time of the exhaust fan for this time period.

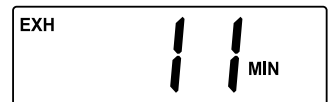

#### EXHAUST DELAY TIME (If using FanConnect™ switch)

This shows the exhaust delay time set.

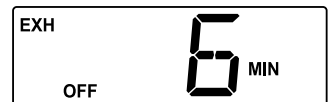

### 6.1 CURRENT SETTINGS

To view the current settings that are programmed in the AirCycler® g2, press the DOWN arrow during Normal Operation. Press the DOWN arrow to advance to each setting. The display will show the following:

#### For Calculated Flow mode the screens will show:

- Required CFM set
- Set measured outside air CFM
- Set measured exhaust air CFM\*
- Set exhaust fan delay time\*
- If operating time is enabled:
  - Operating Time On
  - Operating Time Off

#### For Calculated Time mode the screens will show:

- Exhaust run time set\*
- Outside air time in minutes
- Exhaust fan delay time\*
- If operating time is enabled:
  - Operating Time On
  - Operating Time Off

\*If optional FanConnect™ is connected

### 6.2 SETTING CURRENT TIME

By pressing the MODE key you will cycle through current time of day and will be able to change it if needed.

Note: There is no need to set the current time if you're not using operation hours.

## 6.3 DISABLING THE AIRCYCLER® G2

Warning: It is not recommended to turn off the AirCycler® if the unit is used as a ventilation controller.

**3.4.1** Remove the top of the controller from the base to stop power to the unit and remove any button battery in the unit. Place the unit back on the base.

**3.4.2** On power up, all icons will be illuminated for 3 seconds. Within 3 seconds of powering up press the DOWN arrow to enter set up mode for Calculated Time.

**3.4.3** The first setting is the number of minutes of outside air (OA SET) to be brought into the house per hour. Set this number zero. Press MODE

**3.4.4** *(Only available if FanConnect is installed)* The next setting is the number of minutes of exhaust fan run time. Set this number to zero . Press MODE

**3.4.5** The next setting is the operating 'ON' time. Because you are disabling the system, leave this at the factory defaulted 'NO'. If your system is currently set to 'YS', press the down arrow to change to 'NO'. Press MODE

**3.4.6** *(Only available if FanConnect is installed)* The next setting is the number of minutes the bathroom exhaust fan attached to your FanConnect switch will operate after the switch is moved to the auto (down) position. This allows the fan to continue to run after you have turned the switch off to continue to clean out the air in the bathroom (moisture, cleaning, beauty products, etc). Set this number to zero to completely disable this feature or leave as is. Press MODE

THE UNIT IS DISABLED



**RECORD ALL SETTINGS ON THE INSTALL STICKER  
PROVIDED. LIMITED WARRANTY WILL BE VOID IF THE  
STICKER IS NOT PRESENT.**

## 7.0 INSTALLATION TESTING GUIDE

Testing the *AirCycler® g2-k* completed installation is an easy two step process:

**STEP 1** Test the FanConnect™ connection & operation (if using FanConnect™ switch)

**STEP 2** Test thermostat, damper and furnace connection and operation

### STEP 1

- With the thermostat off, turn on the FanConnect™ switch.
- Confirm the exhaust fan is running
- The AirCycler® g2 display should show the exhaust (bath) fan is ON and the outside fresh air damper is open (OA)
- Confirm the outside fresh air damper is open (OA icon)
- Turn off exhaust fan

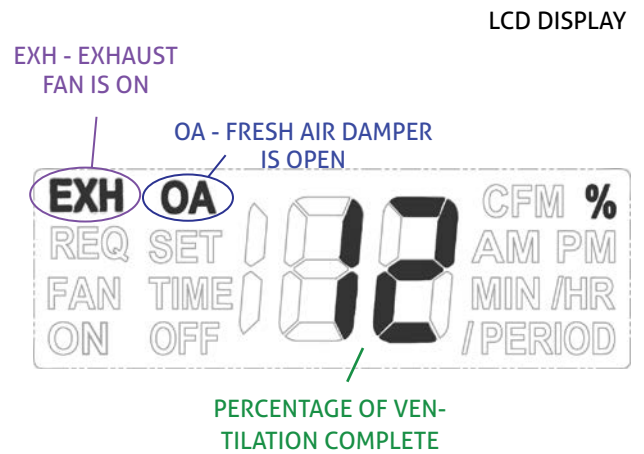

### STEP 2

- Make sure exhaust fan is off (delay time may be running and EXH icon will show)
- Turn thermostat FAN switch to ON
- Confirm AirCycler® g2 display shows FAN and damper open (OA).
- Confirm furnace fan is running
- Remove AirCycler® g2 from it's base. Furnace fan should shut off
- DONE!** Replace AirCycler® g2 controller on it's base

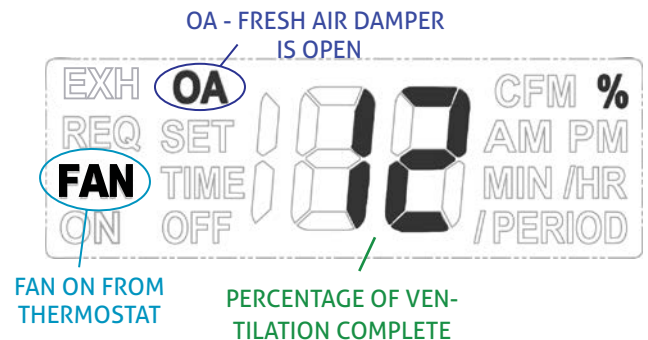

## APPENDIX A

### TROUBLESHOOTING

**Problem: No power to AirCycler® g2**

Check common wire connection. "C" must be connected to "C" on the furnace.

**Problem: EXH icon is flashing**

If the EXH icon is flashing it is indicating that the FanConnect™ switch has been on for more than four hours or has lost connection with the AirCycler® g2 controller.

**Problem: Furnace fan is running constantly**

Make sure the thermostat FAN switch is set to AUTO and not ON

**Problem: Central fan does not shut off when AirCycler® g2 is removed from base (when thermostat fan switch is on)**

Check wiring - "G" wire from thermostat should be wired to "Gt" on AirCycler® g2. "Gf" on AirCycler® g2 should be connected to "G" on furnace.

**Problem: Blank Display on the AirCycler® g2**

Confirm:

1. The furnace has power
2. The thermostat is operational
3. The furnace will call for heat from the thermostat
4. The fan operates with a fan only signal from the thermostat
5. The furnace is providing 24 VAC to the AirCycler® g2
6. Verify wiring conforms to wiring diagram
7. Make sure cover is firmly seated on the base

**Problem: AirCycler® g2 turns furnace fan on and off, but the motorized damper does not cycle.**

Confirm:

1. The AirCycler® g2 is providing a 24 VAC signal to the motorized damper
2. The 24 VAC motorized damper is operational by powering directly with a 24 VAC signal
3. There is continuity in the wiring between the damper and the AirCycler® g2
4. Confirm damper power switch is in up or automatic position

**Problem: A/C turns on during fan cycling calls**

Confirm:

1. Wiring conforms to wiring diagram
2. The G wire is properly connected
3. The G wire needs to be interrupted by the AirCycler® g2
4. Do not run the G wire in parallel

**Problem: The AirCycler® G2 does not detect the optional FanConnect™ switch**

Confirm:

1. Verify the FanConnect™ has power and is in the OFF position

### TIPS

1. Make sure the FanConnect™ switch is in the OFF position when the AirCycler® g2 is first powered on.
2. Setup is easier to start without the battery installed. The battery is only used for the real time clock. If you are not using the operating hours setting, the battery is not needed.
3. To set the AirCycler® g2 to "Inverse Slave Mode" - run the exhaust fan whenever the central fan is not running - enter Calculated Flow setup. Set Measured Supply Air Flow, Measured Exhaust Air Flow, and Required Constant Airflow to the same levels. For example, set all to 60 CFM.

## APPENDIX B

### ASHRAE 62.2 REFERENCE CHART

		Square Footage							
		1000	1500	2000	2500	3000	3500	4000	4500
No. of Bedrooms	1	25	30	35	40	45	50	55	60
	2	33	38	43	48	53	58	63	68
	3	40	45	50	55	60	65	70	75
	4	48	53	58	63	68	73	78	83
	5	55	60	65	70	75	80	85	90

CFM Required:  
 $7.5 \text{ CFM} * (N+1) + A * 0.01$   
N = No. of Bedrooms A = Square Footage

**Technical Support:**

**1.877.FAN.CONTrol**