

Get started



**Download the
LIFX app to begin.**



Get me set up quick!

Ok, here's the basics of what we're going to do...

1. Download and login to the LIFX app
2. Connect your LIFX light to power.
3. Pair your device in the way that best suits you.

How?

Use the instructions here to assemble the pieces, then clamp it to your ground wire like other low voltage garden accessories.



WE'LL SHOW YOU HOW AS SOON AS YOU'RE POWERED UP.

Technical Stuff



2.4 GHz

You'll need a device running **iOS 14.0+** or **Android 8.0+** and a 2.4 GHz **Wi-Fi internet connection**.

Not sure what this is?
See the page 'Your Wi-Fi'.



Prefer to watch videos?
Text here too long?
Visit lifx.com/getstarted

FOR SETUP VIDEOS, INSPIRATION PICS,
DIGITAL MANUALS & MORE...

Ok, so how do I put it all together?

We'll explain quickly how.

1A YOU WANT TO INSTALL IN THE EARTH

Ground Spike: Use this to put the Path light in garden beds and other in-ground locations.

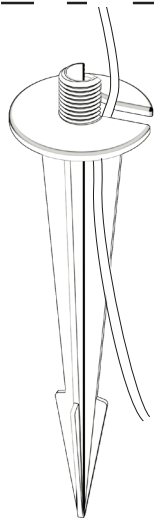

Prepare

Slot the wire on the Path light into the spike. Let the wire hang loose.

Attach to the light

Screw the spike into the Path light base until it's securely attached.

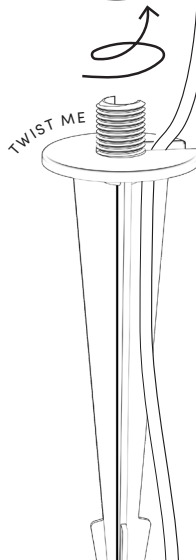
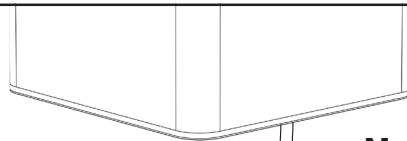

Next, put it in position

Find the desired location and plant the light with attached mounting stake by firmly pressing it into the soil.

A little tough?
Wet the soil or dig a little to soften it up. Ensure the entire stake is in the ground, with the Path light sitting on the surface.

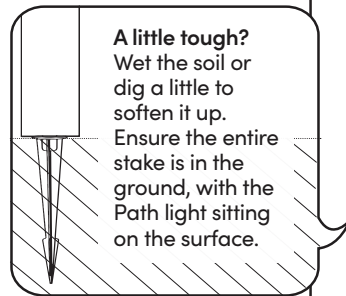

OR

1B YOU WANT TO ATTACH TO A SOLID SURFACE

Mount plate: Use this to affix the Path light to surfaces.

Prepare

Pick the best place to mount your light and thread the cable through the big hole in the middle of the mount.

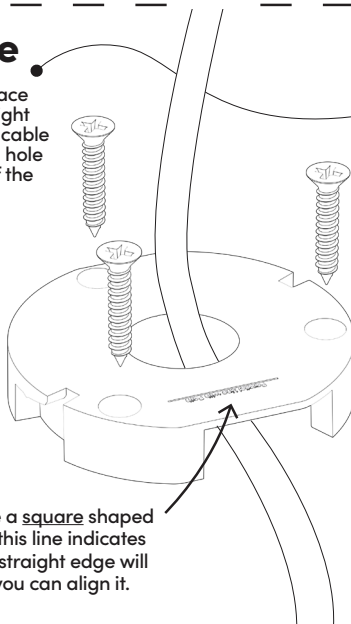

If you have a square shaped LIFX Path, this line indicates where the straight edge will line up so you can align it.

Attach the mount

If you're attaching the mount to wood or softer surfaces, simply install it with the provided screws.

Screwing into masonry?

Position the product then mark where you need your screws. Drill two 1/4" holes. Push in the provided anchors. Line up the mount and install the screws into the anchor. Done!

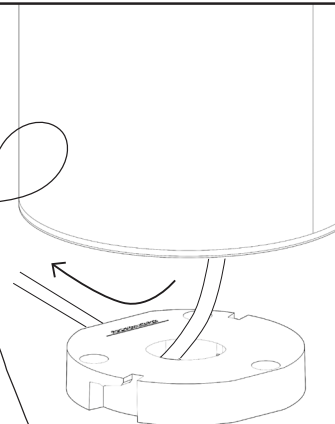

Affix the light

Gently feed the cable through as you lower the Path light onto the attached mount. Line up the notches and put it onto the mount. Twist the light carefully to lock in place.

Cautions:

READ AND FOLLOW ALL SAFETY INSTRUCTIONS

- Connect this product ONLY to a 12V low voltage system with appropriate Wattage allowance available.
- Do not mount or place near gas or electric heaters, fireplace, candles, or other similar sources of heat.
- Do not secure the wiring of the product with staples, nails, or sharp hooks. DO NOT DAMAGE THE WIRE.
- Do not use product for other than its intended use.
- Do not cover the product with cloth, paper or any material not part of the product when in use.
- Keep lamps away from any combustible surface.
- Read and follow all instructions that are on the product or provided with the product.
- This product should be installed out of the reach of children.
- Do not bury the wire more than 6" underground.

↪
Safety first...

Warning:

1. To avoid risk of shock, always make sure the product is disconnected from power before assembling, disassembling, installing, relocating, servicing or cleaning it.
2. Do not overload. Check that the Watts used by this product are within the load limit of your transformer.
3. Make sure all connectors are tightly secured to prevent water entry. Do not submerge.
4. The instructions in this manual are not intended to cover every possible installation, operation, maintenance, or mounting situation.

2 CONNECT THE WIRES

Time to hook this baby up!

Clamp the provided cable to your low voltage system wire, as you would any other accessory lighting product for your setup.

IMPORTANT!

We're checking one last time before you clamp it: Your system is 12V, and you have 33 Watts allowance (after calculations for wiring) left on the attached transformer. Ok, great!

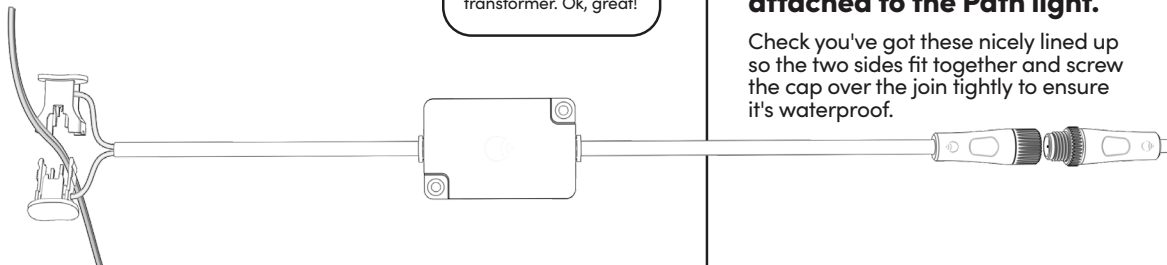

3 THEN...

Connect the end to the wire attached to the Path light.

Check you've got these nicely lined up so the two sides fit together and screw the cap over the join tightly to ensure it's waterproof.

Download the LIFX App (if you haven't yet) **and sign in. Make sure your light is on.**

You'll need our app for the all fun stuff later, like blending awesome colors.

NEXT

GET TECHY WITH

The  **Matter set-up*.**

Your light will notify your device to add it via Matter. Click on this. Pick the smart home platform you want to add your light to.

Why?

Matter is a new, universal system for smart devices to work together seamlessly across 3rd party apps and various services. To use Matter home and away, you'll need a Google, Apple or other smart home hub that's Matter-enabled*. Devices with older hardware may not be compatible.

No notification? No problem. Scan the QR code on the back of this manual to start setup any time.

OR

KEEP IT BASIC WITH

The old-school LIFX way.

Open your LIFX app and hit the + button in the bottom right. We'll guide you through from there.

Why?

You won't need to have any other accounts (like Google or Apple Home, Alexa etc) and you can use the LIFX cloud to control your device from anywhere. You can still use the Matter code on the back of this manual for quick setup in our app.

Want to connect it to Google Home, Apple Home™ or Alexa later? No problems. You can add lights to a 3rd party ecosystem at any time. Just go to settings in your LIFX app to connect any other accounts.

Your Wi-Fi:

Router	802.11 b/g/n	WPA2 security compatible
--------	--------------	--------------------------

LIFX lights connect to your 2.4 Ghz Wi-Fi frequency network, which all routers can be set up for. This offers better range and stability for devices. You may also have a 5 Ghz connection, so if you're not sure which is which, check the current Wi-Fi you're connected to by pressing the Wi-Fi icon on your phone while connected and look at the listed details to find the frequency.

Connection troubles?

Wi-Fi waves can be interrupted by materials like concrete or mirrors. If your signal is weak, try moving your product near your router for setup as it will need a stable connection to complete. If you have lots of devices connected to your router, check the recommended amount. Some routers can handle many devices, others can only support a few.

Apple® and **Apple Home** are trademarks of Apple Inc., registered in the U.S. and other countries and regions. Use of the Works with Apple badge means that an accessory has been designed to work specifically with the technology identified in the badge and has been certified by the developer to meet Apple's performance standards. Apple is not responsible for the operation of this device or its compliance with safety and regulatory standards.

Alexa and all related logos are trademarks of Amazon.com, Inc. or its affiliates.

Google and **Google Home** are trademarks of Google LLC.

Samsung, SmartThings and all related logos are trademarks of Samsung Electronics Co., LTD. or its affiliates.

Quick FAQs

How do I reset a light if I need to?

To take an outdoor light back to it's original settings, unplug and replug the LIFX Connector 5 times, at a rate of about one time a second. The lights will cycle through four colors and stop on white when the reset has been successful. This is how you would remove a light from a network to then add it to a new one.

I've set up a new network / changed my password, how do I re-connect my lights?

If you've changed your Wi-Fi password or set up a new router with a new password, you'll need to reset your lights (as above) and reconnect them with the new Wi-Fi information and security. If you've moved house but your network is named the same and has the same password, your lights are all ready to go!

Need more help?

Visit the LIFX Help Center at support.lifx.com

Regulations & Compliance.

FCC Compliance Statement U.S.

This equipment has been tested and found to comply with the limits for a Class B digital device, under Part 15 of the FCC Rules. These limits provide reasonable protection against harmful interference in a residential installation. This equipment generates, uses and can radiate radio frequency energy and, if not installed and used under the instructions, may interfere with radio or television reception, which can be determined by turning the equipment off and on. The user is encouraged to correct the interference by one or more of the following measures:

- Reorient or relocate the receiving antenna
- Increase the separation between the equipment and the receiver
- Connect the equipment into an outlet on a circuit different from that to which the receiver is connected
- Consult the dealer or an experienced radio/TV technician for help

Changes or modifications not approved by LIFX can void the user's authority to operate the equipment.

This device complies with Part 15 of the FCC Rules. Operation is subject to the following two conditions: (1) This device may not cause harmful interference, and (2) this device must accept any interference received, including interference that may cause undesired operation.

Contains FCC ID: SYW-LCM4

Changes & modification

Changes or modifications made to this device may void certification of the device. Changes or modifications made to this unit not expressly approved by the party responsible for compliance could void the user's authority to operate the equipment.

Frequency Information

Frequency Range (US & Canada): 2412-2472 MHz;

Maximum radio-frequency power transmitted: 22.50dBm;

Modulation type: IEEE 802.11 b/g/n/ax

Installation requirements & recommendation

This device should only be installed in light fittings and fixtures that are designed to accept each fitting. Lamps, fittings and fixtures that are designed to accept smaller or lower wattage light bulbs may result in the LIFX bulb operating below its optimal capacity. For optimal performance it is recommended that LIFX bulbs be fitted into fixtures that provide sufficient air flow through and around the bulb. It is recommended that the LIFX bulb be installed away from other devices designed to receive or transmit radio signals. It is recommended LIFX bulb/s be installed and operated at a minimum distance of 30 cm from the body. For lamps with a weight significantly higher than that of lamps for which they are a replacement, attention should be drawn to the fact that the increased weight may reduce the mechanical stability of certain luminaires and may impair contact making and lamp retention.

Interference

LIFX has been designed to minimize interference with other radio, broadcast or receiving devices. The manufacturer is not responsible for any interference caused as a result of modifications to the product or by failure to adhere to the recommendations in this document and at support. lifx.com. This device generates radio frequency energy and, if not installed in accordance with the "recommended installation requirements" may cause harmful interference to radio communication devices. If the device is causing radio interference it is recommended that the user try:

- a. relocating the device to a different place;
- b. adjust the antenna on the receiving device;
- c. consult a technician experienced in radio interference.

Notices

- This device is not intended for use with emergency exits
- Only use the control provided with or specified by these instructions to control this lamp. This lamp will not operate properly when connected to a standard (incandescent) dimmer or dimming control.

LIFX is not designed for use in:

- Excessively hot environments (e.g. close to ovens, radiators, heaters, etc.)
- Regions or countries other than that in which the product was intended for
- Outdoor and wet areas, except where the LIFX Product specifies that it is for Outdoor use.

When using LIFX

- To avoid risk of shock, always make sure the product is unplugged from the electrical outlet before assembling, disassembling, installing, relocating, servicing or cleaning it.
- Do not open device, as this will void the warranty
- If cleaning the product, use a soft dry cloth, do not use cleaning agents

Limited Warranty

General

Feit Electric Co ("LIFX") warrants the LIFX bulb (the "Product"), and only the Product, against defects in materials and workmanship under normal use ("Defect") for a period of TWO YEARS (730 days) from the date of retail purchase by the original purchaser ("Warranty Period"). Under this Limited Warranty, if a defect arises and a valid claim is received by LIFX within the Warranty Period, at its option and to the extent permitted by law, LIFX will either: 1. repair the Product at no charge, using new or refurbished replacement parts --or-- 2. exchange the Product with a new or refurbished Product.

In the event of a defect, to the extent permitted by law, these are your sole and exclusive remedies. A replacement Product or part assumes the remaining warranty of the original Product or ninety (90) days from the date of replacement or repair, whichever is longer. When a Product or part of the Product is exchanged, any replacement item becomes your property and the replaced item becomes LIFX's property. Parts provided by LIFX in fulfillment of its warranty obligation must be used in Products for which warranty service is claimed.

Exclusions & Limitations

This Limited Warranty applies only to the Product manufactured by or for LIFX that can be identified by the "LIFX trademark, trade name, or logo affixed to it. The Limited Warranty does not apply to any (a) LIFX products and services other than the Product, (b) non- LIFX hardware product, (c) consumables (such as batteries), or (d) software, even if packaged or sold with the Product or embedded in the Product. Refer to the licenses accompanying the software for details of your rights with respect to its use. LIFX does not warrant that the operation of the Product will meet your needs or requirements or be uninterrupted or error free. LIFX is not responsible for damage arising from failure to follow instructions relating to the Product's use or from failures resulting from inadequate electrical supply or internet access. This warranty does not apply to a Product or part of the Product that has been altered or modified (e.g. to alter functionality or capability) by anyone who is not a representative of LIFX or if the Product is inserted or installed in a casing not provided by LIFX. In addition, this Limited Warranty does not apply to Defects or damage caused by (a) use with non-LIFX products; (b) accident, abuse, misuse, flood, fire, earthquake or other external causes or abnormal conditions; (c) operating the product outside the permitted or intended uses or conditions described by LIFX or with improper

voltage or power supply; or (d) service (including upgrades and expansions) performed by anyone who is not a representative of LIFX. Recovery and re-installation of software programs and user data are not covered under this Limited Warranty. This Limited Warranty does not cover the cost of returning the Product to LIFX; this is your responsibility. No LIFX reseller, agent, or employee is authorized to make any modification, extension, or addition to this Limited Warranty. If any term is held to be illegal or unenforceable, the legality or enforceability of the remaining terms shall not be affected or impaired.

EXCLUSIVE WARRANTIES

THE WARRANTIES SET FORTH HEREIN ARE THE EXCLUSIVE WARRANTIES PROVIDED BY LIFX, AND EXCEPT TO THE EXTENT PROHIBITED BY APPLICABLE LAW, ALL OTHER WARRANTIES, WHETHER EXPRESS OR IMPLIED WARRANTIES (INCLUDING WARRANTIES OF MERCHANTABILITY, FITNESS FOR A PARTICULAR PURPOSE AND NON INFRINGEMENT) ARE HEREBY EXCLUDED.

LIMITATION OF DAMAGES

EXCEPT TO THE EXTENT PROHIBITED BY APPLICABLE LAW, LIFX SHALL NOT BE LIABLE FOR ANY INCIDENTAL, INDIRECT, SPECIAL, OR CONSEQUENTIAL DAMAGES RESULTING FROM ANY USE OF THE PRODUCT OR BREACH OF EXPRESS OR IMPLIED WARRANTY OR CONDITION, OR UNDER ANY OTHER LEGAL THEORY. LIFX'S LIABILITY FOR DAMAGES RESULTING FROM ANY USE OF THE PRODUCT OR BREACH OF EXPRESS OR IMPLIED WARRANTY OR CONDITION, OR UNDER ANY OTHER LEGAL THEORY WILL BE LIMITED TO THE ORIGINAL COST PAID FOR OF THE DEFECTIVE PRODUCT.

Consumer Protection

Some states do not allow the exclusion or limitation of incidental or consequential damages, or allow limitations on how long an implied warranty lasts, so the above limitations or exclusions may not apply to you. This warranty gives you specific legal rights, and you may also have other rights that vary by state to state.

Governing Law and Arbitration

This Limited Warranty shall be governed by the laws of the State of California without giving effect to any conflict of laws principles that may provide the application of the law of another jurisdiction and without regard to the Convention on Contracts for the International Sale of Goods. Any claim or dispute in connection with this Limited Warranty shall be resolved in a cost effective manner through binding

non appearance based arbitration. The arbitration shall be initiated through an established alternative dispute resolution provider mutually agreed upon by the parties. The alternative dispute resolution provider and the parties must comply with the following rules: a) the arbitration shall be conducted by telephone, online and/ or be solely based on written submissions, the specific manner shall be chosen by the party initiating the arbitration; b) the arbitration shall not involve any personal appearance by the parties or witnesses unless otherwise mutually agreed by the parties; and c) any judgment on the award rendered by the arbitrator may be entered in any court of competent jurisdiction. If the foregoing arbitration clause does not apply for any reason, you agree to submit to the personal jurisdiction of the state courts located within San Francisco County, California and the federal courts in the Northern District of California for the purpose of litigating all such claims or disputes, which courts shall have exclusive jurisdiction of such claims or disputes. Notwithstanding the foregoing, LIFX may seek injunctive or other equitable relief to protect its intellectual property rights in any court of competent jurisdiction.

Product Details

Chromaticity co-ordinates: colored light

$$x < 0,270 \text{ or } x > 0,530$$

$$y < -2,3172 x^2 + 2,3653 x - 0,2199$$

$$\text{or } y > -2,3172 x^2 + 2,3653 x - 0,1595$$



Minimum starting temperature.



Reaches 100% brightness in 1 second or less.



High quality LEDs rated for 25,000 hours of use.



Connects to your routers 2.4GHz Wi-Fi band.

Wi-Fi 802.11 b/g/n
12-15V AC 60Hz or
12-15V DC Rating
(Input)

LIFX works diligently to ensure that LIFX products and their packaging materials comply with all relevant regulations in the regions we supply. We will also provide on request information regarding compliance if it is not immediately available at the link below.

See lifx.com/compliance for notices for your region.



RoHS



SUPER QUICK SETUP



IMPORTANT!

You'll want to keep this code for later.

**This is your matter code.
It's for quick setup and for a
more connected smart home
experience. Awesome, right?**

Scan this when your LIFX product is powered up to and it'll guide you through.

FEIT ELECTRIC CO. is the exclusive owner of rights and interests in and to the mark LIFX and the LIFX logo. Covered by patents.
lifx.com/patents

© 2023, All rights reserved.