

BENCHMARK





Versatile & Flexible

Modern design with superb reliability, Benchwork Desking creates a no-frills desking experience making it the ideal daily driver in any office space.



Cluster of 2

Desktop Screen, Mobile Pedestal



Cluster of 4

Desktop Screen, Structure Cabinet



Stylish and Practical

Benchwork is ideal for quick installation, creating functional, stylish and practical solutions for different uses in the office. With its minimalist and seamless design, Benchwork helps in making spaces seem larger. Furthermore, the components can be optimally reused and reconfigured into multiple arrangements thus reducing material wastages.



Integrated Cable Management System

Excess cables are stored within the wire console while sockets are mounted on access panels for quicker access.



Allen Key Assembly & Adjustment

Fast & easy installation



Extendable Beam

Adjustable beam length to allow reconfiguration



Quality Assurance & Certification

Comply with strict FIRA, AFRDI & PEFC standards and guidelines



Limitless Configuration

Benchwork's exceeding versatility allows the desking system to adapt to a broad range of configurations, from normal to complex design requirements.

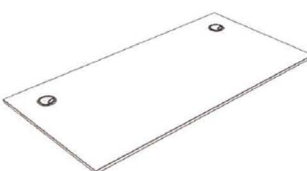

Rectangular Worktop with Grommet Hole



Mobile Pedestal 2D (1 drawer + 1 filing)

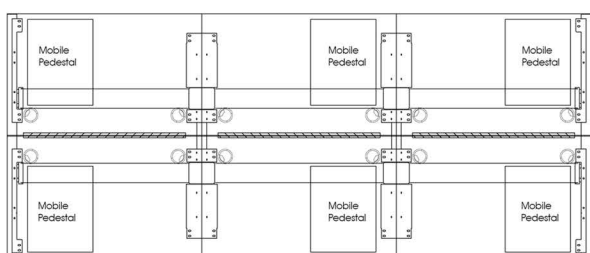

	L	W	THK
BW 1275	1200	750	25
BW 1475	1400	750	25
BW 1675	1600	750	25

	L	W	H
WS M1D1F	400	460	595

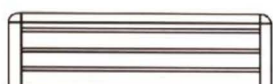
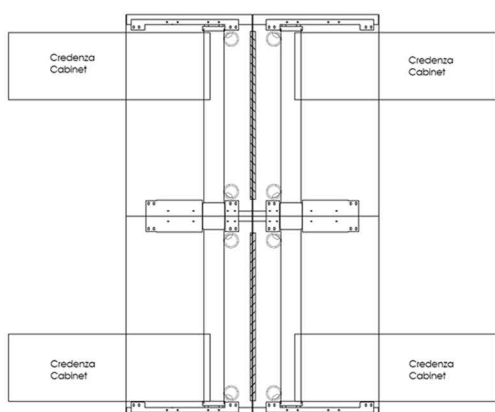

Aluminium Desktop Screen

	L	H	THK
FW S 10A	1000	360	23
FW S 12A	1400	360	23
FW S 14A	1200	360	23
FW S 15A	1200	360	23
FW S 16A	1200	360	23

* Comes in 520mm H as well

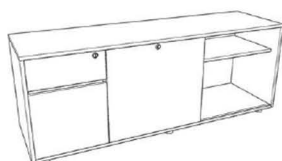

Credenza Cabinet

	L	W	H
BW CRZ16046600	1600	460	600
BW CRZ14046600	1400	460	600
BW CRZ12046600	1200	460	600

Table Top

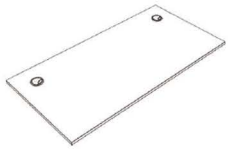

01

Rectangular Worktop W/
Grommet Hole

	L	W	THK
BW 1275	1200	750	25
BW 1475	1400	750	25
BW 1675	1600	750	25

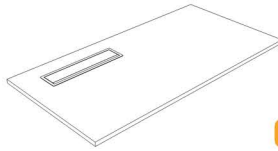

02

Rectangular Worktop W/
Flip Opening

	L	W	THK
BW 1275 (O/L-4)	1200	750	25
BW 1475 (O/L-4)	1400	750	25
BW 1675 (O/L-4)	1600	750	25

* With FAM/PH flip opening
* Opening can be positioned left, center or right
* For 1200L table, use 300L
* For 1400L - 1600L table, use 400L

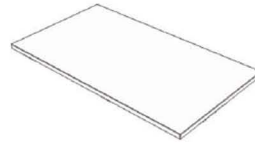

03

Side Return Worktop

	L	W	THK
BW SR8060	800	600	25
BW SR9060	900	600	25
BW SR10060	1000	600	25
BW SR11060	1100	600	25



04

Executive Table Set

	L	W	H
BWE 1890	1800	900/700	720

* Comes with modesty panel
* CLM SRBUL (W) Leg - 2 Nos
* CLM SB 1218 (W) - 1 Nos

Component

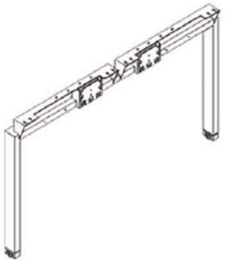

01

Twin Row Universal Leg

CLM TRBUL (W)	(for 750W)
CLM TRBUL 1200 (W)	(for 600W)

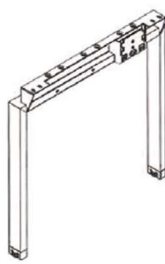

02

Single Row Universal Leg

CLM SRBUL (W)	(for 750W)
CLM SRBUL 600 (W)	(for 600W)

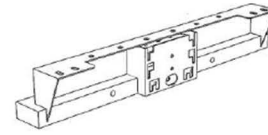

03

Structure Cabinet Leg

BW SB 800	(for 750W)
BW SB 600	(for 600W)

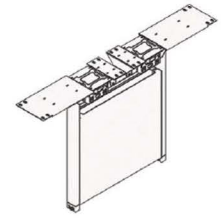

04

Twin Row Inner Leg

CLM TRBIL (W)	(for 1200W-1500W)
---------------	-------------------

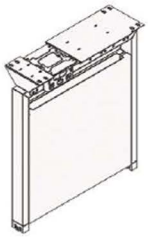

05

Single Row Inner Leg

CLM SRBIL (W)	(for 600W - 750W)
---------------	-------------------

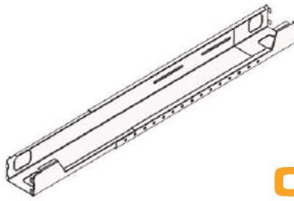

06

Telescopic Beam

CLM CB 812 (W)	(for 600L - 1200L)
CLM CB 1218 (W)	(for 1200L - 1800L)
CLM CB 1824 (W)	(for 1800L - 2400L)

Storage



01

Open Shelf Low Cabinet

	L	W	H
BW 08045800	800	450	800
BW 08040800	800	400	800

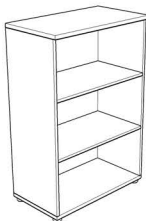

02

Open Shelf Mid Height
Cabinet

	L	W	H
BW 080451200	800	450	1200
BW 080401200	800	400	1200



03

Wooden Door High
Cabinet

	L	W	H
BW 01975 WD	800	450	1975

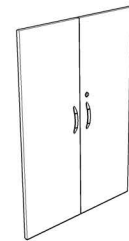

04

Wooden Door (For
Open Shelf Cabinet)

	H	W
BW 800 WD	745	794
BW 1200 WD	1145	794

* Comes with lock and handle

Storage



05

Mobile Pedestal 2D
(1 Drawer + 1 Filing)

	L	W	H
WS M1D1F	400	460	595

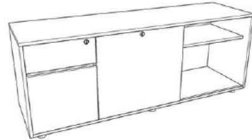

06

Credenza Cabinet

	L	W	H
BW CRZ16046600	1600	460	600
BW CRZ14046600	1400	460	600
BW CRZ12046600	1200	460	600

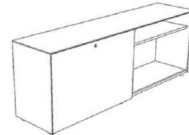

07

Structure Cabinet

	L	W	H
BW SC16038600	1600	380	600
BW SC14038600	1400	380	600
BW SC12038600	1200	380	600



08

Side Return Fixed
Pedestal

	L	W	H
BW SR10046720	1000	460	720
BW SR10060720	1000	600	720

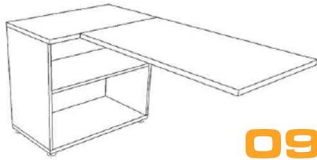

09

Side Return with OS

	L	W	H
BW SROS XXXXXX	1000	450	720



10

Sliding Door Cabinet with
OS

	L	W	H
BW OSS80451200	800	450	1200

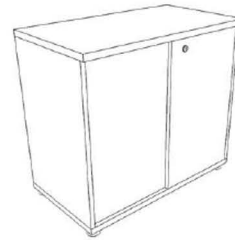

11

Sliding Door Cabinet

	L	W	H
BW S8045750	800	450	750

Accessories

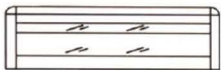

01

Glass & Etched Desktop
Screen

	L	W	THK
FW S 10GE	1000	360	23
FW S 12GE	1200	360	23
FW S 14GE	1400	360	23
FW S 15GE	1500	360	23
FW S 16GE	1600	360	23

* Comes in 520mm H as well



02

Full Fabric Desktop Screen

	L	W	THK
FW S 10SFF	1000	360	23
FW S 12SFF	1200	360	23
FW S 14SFF	1400	360	23
FW S 15SFF	1500	360	23
FW S 16SFF	1600	360	23

* Comes in 520mm H as well



03

Aluminium Desktop Screen

	L	W	THK
FW S 10A	1000	360	23
FW S 12A	1200	360	23
FW S 14A	1400	360	23
FW S 15A	1500	360	23
FW S 16A	1600	360	23

* Comes in 520mm H as well



04

Pen Tray

FW PT



05

Multi Purpose Tray

FW MPT



06

A4 Paper Tray Landscape

FW PTL



07

CPU Holder

FW PTL