

Owner's Purchase Record

Model _____

Date of Purchase _____

Dealer Purchased From: _____

Serial #: _____

Copyright BRUNTON, 2001

Printed in U.S.A.
form 11-GEO rev. 0109



**GEO TRANSIT
OPERATOR'S MANUAL**

1 – Orientation	Page(s): 1
2 – Magnetic Declination	5
3 – Azimuth Measurement	7
4 -- Inclination & Percent Grade Measurement	11
5 – Strike & Dip Measurement	14
6 – Trend & Plunge Measurement	15
7 – GEO Transit & Topographic Map Use	16
8 – Additional Measurements	18
9 – Prospecting	19
10 – Reference Material	25
11 – Specifications	26
12 – Service	26

1 -- Orientation

Congratulations on your purchase of the finest pocket transit instrument in the world. The Brunton GEO Transit is not just a compass. It combines a surveyor's compass, prismatic compass, two inclinometers, hand level and a plumb into a single instrument.

Even though the GEO Transit is made rugged and durable to withstand the rigor associated with outdoor use, care must be taken to assure long-life of your instrument. Avoid impacts, dropping, extreme temperatures and store the Brunton GEO Transit in its case.

Orientation provides a description of important pocket transit parts. A detailed description of its operation is provided throughout the manual.

Opening The GEO Transit

Position the GEO Transit so that the flat cover faces up with the small window positioned away from you. Unlatch the cover from the base. (Fig 1)

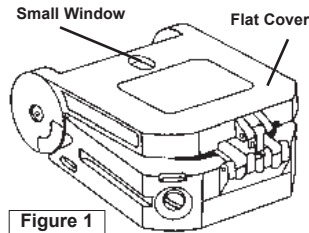

Figure 1

1.1 Round Level (Fig 2)

For accurate azimuth measurement, dip direction and trend measurements, center the bubble in the round level.

1.2 Needle (Fig 2)

The needle is attached to a rare earth magnet which is induction damped, allowing the needle to seek magnetic north and come to a complete rest in a minimum amount of time.

1.3 Graduated Circle (Fig 2)

In combination with the needle, the 1° graduated circle allows for azimuth readings that are accurate to 1/2 degree.

Figure 2

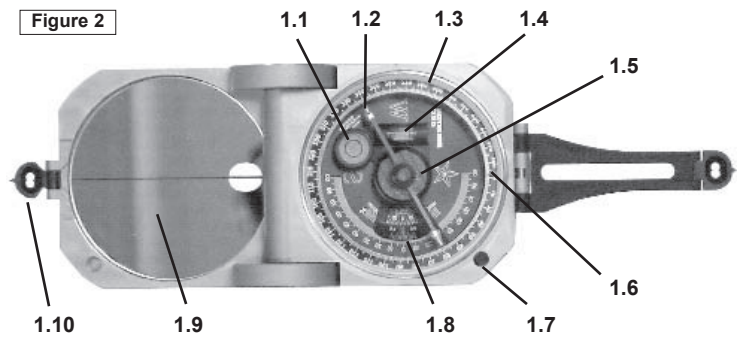

1.4 Long Level (Fig 2)

The long level is for inclination measurement. For accurate inclination measurement, center the bubble in the long level using the vernier adjustment (section 1.14).

1.5 Rare Earth Magnet (Fig 2)

Brunton has incorporated a cast NdFeB, rare-earth magnet which seeks magnetic north very quickly and allows for faster needle settling.

1.6 Zero Pin (Fig 2)

The zero pin a pointer used for magnetic declination adjustment. If no adjustment is necessary, the pin should point at 0° on the azimuth ring.

1.7 Needle Release Mechanism -- 2-Positions (Fig 2)

Unlocked: When needle locking adjustment (section 1.15) is unlocked the needle swings freely, even when needle release mechanism is pressed.

Locked: When needle locking adjustment is in the locked position the needle is locked in place until the needle release mechanism is pressed. **(Suggested for Storage)**

1.8 Vernier (Fig 2)

The vernier is used for inclination measurements with an accuracy to 30 minutes.

1.9 Mirror (Fig 2)

The mirror and mirror center line are used for accurate azimuth and inclination measurements.

1.10 Small Sight (Fig 2)

Attached to the cover, the small "buckhorn" style sight is used for precise bearing and inclination sighting.

1.11 Ball & Socket Tripod Mount (Fig 3)

Use the slots on both sides of the body for mounting the GEO to the optional Brunton ball & socket mount, which in turn attaches to an optional Brunton tripod, or monopod.

1.12 Magnetic Declination Adjustment Screw (Fig 3)

Adjust the GEO Transit for magnetic declination, by turning the declination adjustment screw using a flat-head screw driver.

1.13 Large Sight w/ Peep Sight (Fig 3)

The large sight and the attached "buckhorn" style peep sight are used for precise azimuth and inclination measurement.

1.14 Vernier Adjustment (Fig 3)

The vernier adjustment rotates the vernier and long level for inclination measurements.

1.15 Needle Locking Adjustment -- 2-Positions (Fig 3)

Adjust the needle locking lever to lock and unlock the needle.

1.16 Side/Bottom Long Levels (Fig 3)

When it is not possible to view the round level, use the side/bottom, long levels to level the GEO transit for azimuth and inclination measurement .

1.17 Hinge Inclinometer (Fig 3)

Measure inclination using the lid and at least one of the bubble levels.

Storage

For storage, Brunton recommends locking the needle adjustment lever (1.15) and placing the GEO transit in its case, with the base against the closing snap. (Fig 4)

Direct Reading

Why are EAST & WEST switched?

The GEO Transit is a **direct reading** compass. Read azimuth **directly** where the needle points on the graduated circle.

With the large sight toward the object, read azimuth directly where the north end of the needle points ("N" tip). (Fig 5)

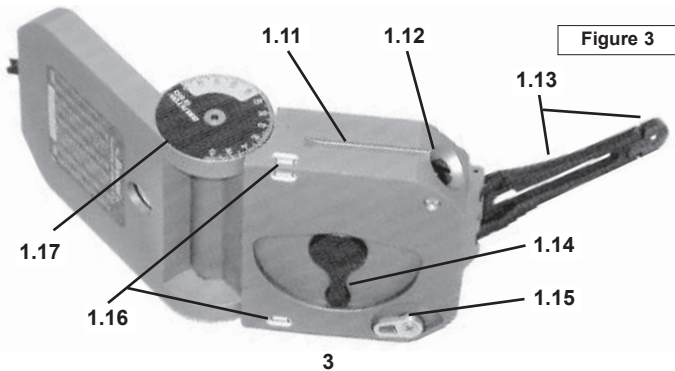

Figure 3

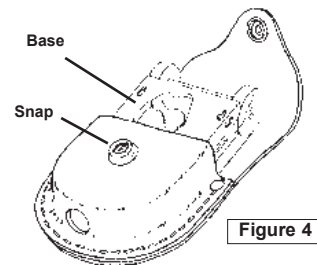
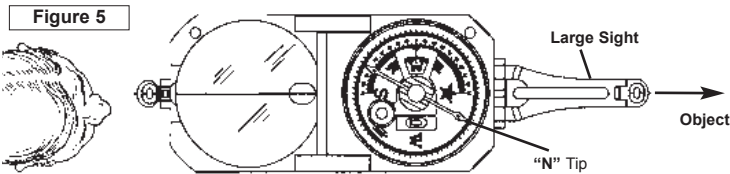
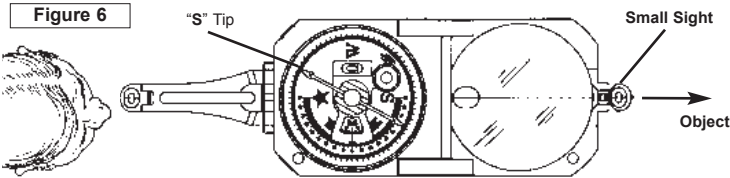

Figure 4



With the small sight toward the object, read azimuth directly where the south end of the needle points ("S" tip). (Fig 6)



See section 4 for detailed explanation of sighting an azimuth.

2 -- Magnetic Declination

The Earth is completely surrounded by a magnetic field, and an unobstructed magnetized object will orient itself with the earth's magnetic north and south poles. Magnetic declination (variation) is the difference between true, geographic north (North Pole) and magnetic north (in northern Canada), with respect to your position. It is important to note magnetic declination at your position, because magnetic declination varies and fluctuate slowly at different rates, around the world.

The isogonic chart (Fig 7) shows North America, only. Use the isogonic chart, a current United States Geological Survey (USGS), Bureau of Land Management (BLM), another map, or a computer program to determine magnetic declination at your position.

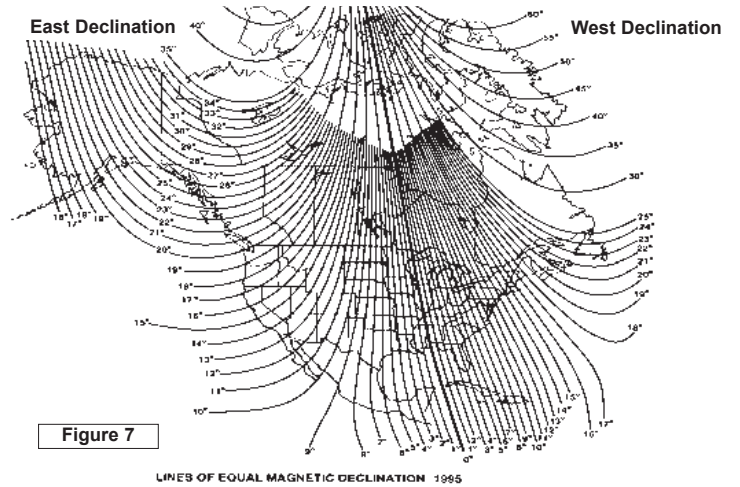

Declination can be east, west or 0°, from your current position. At 0° declination, true north and magnetic north are aligned.

Example: If magnetic declination at your position is 15° east, then magnetic north is 15° east of true, geographic north. Figure 8 displays true geographic north and magnetic north, as indicated in the legends of USGS and BLM maps.

Most maps use true north as a reference. When adjustment for magnetic declination is complete, azimuth readings will be with respect to true north, same as the map.

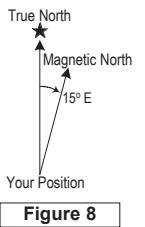

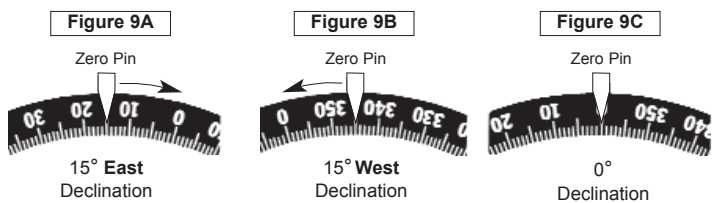

Using the magnetic declination adjustment (1.12, pg. 3), rotate the graduated circle to adjust for declination. Begin with the zero pin at 0°. For **East** declination, rotate graduated circle **clockwise** from the zero pin. (Fig 9A) For **West** declination, rotate graduated circle **counter-clockwise**. (Fig 9B) If magnetic declination is 0°, no adjustment is necessary. (Fig 9C)

3 -- Azimuth Measurement

Azimuth is a term used for direction. Azimuth is normally measured clockwise, in degrees with true north being 0°. Bearing is a term often used when measuring with a quadrant type instrument. From this point forward, description of pocket transit use will involve the 0° through 360° graduated circle, and with the assumption the GEO transit is adjusted for magnetic declination.

Example of Azimuth: If a mountain is directly east of your position, the azimuth from your position to the mountain is 90°. If the mountain is directly south, it would be at 180°.

Warning: The magnetic needle is highly sensitive. When sighting an azimuth, keep the GEO transit away from magnetic materials, such as watches, belt buckles, rings, knives, etc.

3.1 Needle Locking Adjustment

Before measuring an azimuth a decision must be made to have the needle swing freely, or be locked until the needle release mechanism is pressed.

3.1.a Needle Swings Freely (Unlocked)

1. Position the GEO so that the base faces you and the needle locking adjustment is on top.

7

2. Rotate the needle locking adjustment lever clock-wise. (Fig 10)

Now the needle swings freely, even when needle release mechanism is pressed.

3.1.b Needle Locked (Locked)

1. Position GEO transit so that the base faces you with the needle locking adjustment on top. (Fig 10)
2. Rotate the needle locking adjustment lever counter clock-wise.

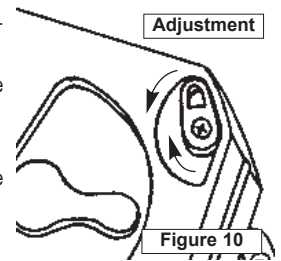

The needle remains locked until the needle release mechanism is pressed. When the needle settles, let up on the release mechanism to lock azimuth measurement in place.

3.2 Azimuth Using a Tripod or Monopod

For highest accuracy, mount the GEO transit on a Brunton non-magnetic tripod using the Brunton ball and socket head.

1. Adjust GEO transit for magnetic declination.
 - See section 2, Magnetic Declination, for help.
2. Mount transit to the ball and socket head.
3. Open the cover and large sight until they both extend in a straight line. (Fig 11)
4. Flip small sight and peep sight up.
5. Rotate transit until large sight points at object.
6. Level the transit by centering bubble in round level.

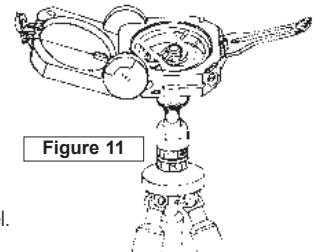

7. Sight azimuth by aligning peep-sights with object. (Fig 12)

8

8. Read azimuth where the "N" end of the needle points at graduated circle. (Fig 13)

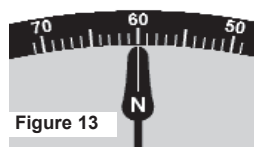

Figure 13

3.3 Azimuth Measurement Waist-Level

This method is often used when object is above or below the observer.

3.3.a Using "N" End of Needle

Use this method when the object lies as much as 45° above, or 15° below the observer.

1. Hold transit waist high and in your left hand.
2. Open cover toward your body. (Fig 14)
3. Open large sight, until perpendicular to the body. (Fig 14)

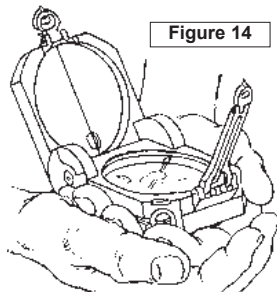

Figure 14

4. Press left forearm against your waist and steady with right hand.
5. Level compass using round bubble level.
6. In the mirror's reflection, bisect the object with the mirror center line. (Fig 15)
 - Check that the bubble is centered in the round level.
7. Read azimuth where the "N" end of needle points at the graduated circle.

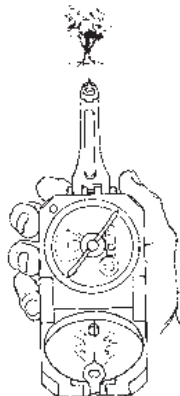

Figure 15

If object is more than 45° above you, open mirror further toward your body, and adjust large sight so that it leans over the bottom case.

3.3.b Using "S" End of Needle

Use this method when object is more than 15° below the observer.

1. Hold transit waist high and in your left hand.

2. Open cover away from your body. (Fig 16)
3. Open large sight until it leans over the body.
4. Press left forearm against your waist and steady with right hand.
5. Look just over the large sight, and at the object through window opening on mirror. (Fig 16)
 - Adjust mirror and large sight so that the image of the large peep sight are bisected by the mirror center line.
6. Level compass using round bubble level.
7. Read azimuth where the "S" end of needle points at the graduated circle. (Fig 17)

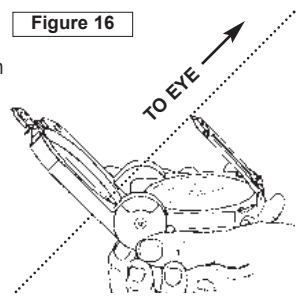

Figure 16

3.4 Using as a Prismatic Compass

Occasionally, objects may interfere with sighting using methods previously mentioned, or users may encounter circumstances which require the GEO be held at eye-level to sight an object. If this is the case, follow the procedures below.

1. Open cover away from your body to approximately 45°, and open small sight. (Fig 18)
2. Lift large sight until perpendicular to the transit body, or leans slightly away from the base.
3. Hold instrument at eye-level, with large sight toward you.
4. Align large sight and small sight on top of the cover with object.
 - OR - Sight object through the lower portion of large sight and the window in the mirror.
5. Level round bubble level using the reflection of the mirror.
6. Read azimuth in the reflection of the mirror where the "S" end of needle points at the graduated circle.

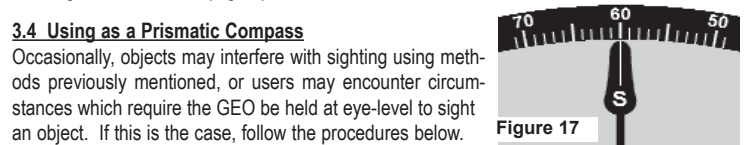

Figure 17

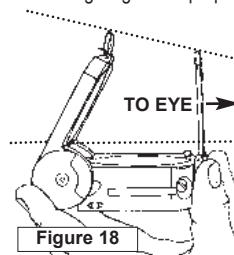
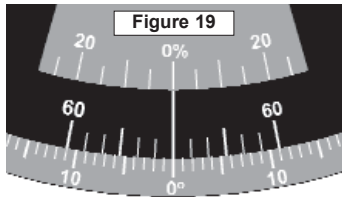

Figure 18

4 -- Inclination & Percent Grade Measurement

The Brunton GEO Transit is capable of measuring vertical angles with an accuracy better than 1°, with readings to 10 minutes. Also, it displays percent grade, without calculation.

The bottom scale is incremented from 0° to 90° and is used for vertical inclination. The scale on the vernier is also used for vertical (inclination) measurement, but it is incremented from 0 to 60 minutes. (Fig 19) Closer to the center, the second scale increments from 0% to 100%. This scale is the percent grade scale.



4.1 Inclination and Percent Grade Using Tripod or Monopod

Use a tri/monopod for increased inclination accuracy.

1. With GEO transit attached to the tripod tilt the ball and socket mount 90°. (Fig 20)
 - Transit should be on its side.
2. Lock into position using the clamp screw.
3. Align sights with object behind transit. (Fig 20)
4. Adjust vernier until bubble is centered in long level.
5. Read inclination at vernier's center line from the degree scale -- 26° to 27°, circled. (Fig 21)

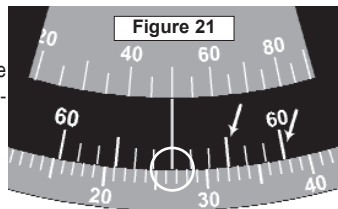
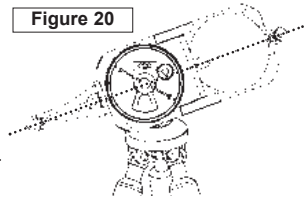

11

4.1.a -- inclination to the nearest 30 minutes

When 30 minute accuracy is required, use the vernier scale (0 -- 60 minutes with 10 minute increments).

1. Read inclination at vernier's center line -- 26° + ___', circled. (Fig 21)

2. Find minutes by determining whether the 30 or 60 minute line is closest to a degree marking. See arrows in figure 21. A Loupe or magnifier may be required.

Since the 30 minute line is closest, the total angle is 26° + 30' (26° 30' or 26.50°)

4.1.b -- percent grade

Use the percent grade scale above the vernier.

1. Read nearest percent grade at the vernier's center line -- 50%, circled. (Fig 22)

Another method is to *calculate* the percent grade using the angle of inclination and the equation:

$$\text{Percent Grade} = [\tan(\theta) \times 100]$$

Measure the angle of inclination, $\theta = 26.5^\circ$. Then, calculate the tangent of 26.5° using a calculator. Finally, move the decimal two places to the right (multiply by 100).

Example: $\tan(26.5^\circ) = .499 = 49.9\% \text{ Grade}$

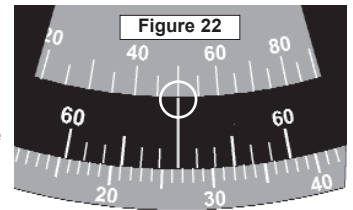

4.2 Inclination Using Prismatic Compass

The GEO transit can also measure angles of inclination without a tripod.

1. Position cover to approximately 45°.
2. Open large sight and flip its peep sight to 90° from the large sight. (Fig 23)
3. With large sight pointing toward you, position transit at eye-level with cover open to the right. (Fig 23)
4. Sight object behind transit, aligning small sight, window and peep sight with object.
5. In the mirror, adjust vernier until bubble is centered in the long level
6. Read inclination at vernier's center line.

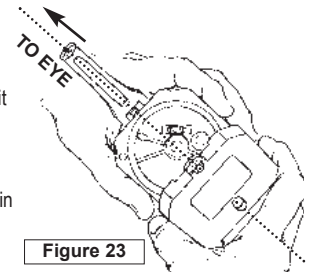

12

4.2.a Height Measurement Using Vertical Angles

1. Sight inclination, as described in section 4.2.
2. Apply height calculation as shown in figure 24A or 24B.

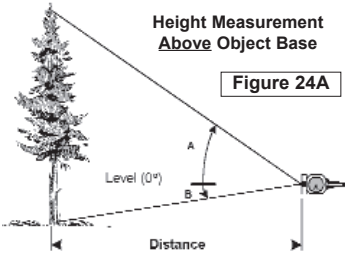

Figure 24A

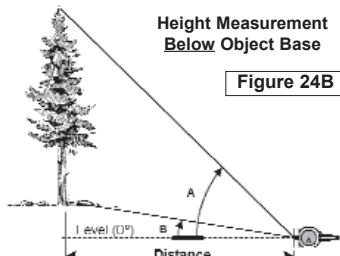

Figure 24B

Note: Do not calculate tangent of an angle by adding tangents of two smaller angles.

Example: $\tan(60^\circ) \neq \tan(30^\circ) + \tan(30^\circ)$ Find $\tan(60^\circ)$ from a table, use a calculator, or step back until angle of inclination is less than 45° , then use tangent table on the GEO lid.

Above Object Base

$$\text{Height} = (\tan A + \tan B) \times \text{Distance}$$

Example: $A = 36^\circ$, $B = 10^\circ$ & Distance = 50 ft.

$$\text{Height} = (\tan 36^\circ + \tan 10^\circ) \times 50'$$

$$\text{Height} = (.727 + .176) \times 50'$$

$$\text{Height} = (.903) \times 50'$$

$$\text{Height} = 45.15 \text{ ft.} = 45'$$

Below Object Base

$$\text{Height} = (\tan A - \tan B) \times \text{Distance}$$

Example: $A = 38^\circ$, $B = 10^\circ$ & Distance = 75 ft.

$$\text{Height} = (\tan 38^\circ - \tan 10^\circ) \times 75'$$

$$\text{Height} = (.781 - .176) \times 75'$$

$$\text{Height} = (.605) \times 75'$$

$$\text{Height} = 45.38 \text{ ft.} = 45'$$

4.2.b Height Measurements Using % Grade

1. Sight % grade using level or sloping ground, same as in Figures 24A & 24B.
2. Apply height calculation, as show in figures 25A & 25B.

Above Object Base

$$\text{Height} = (A + B) \times \text{Distance}$$

Example: $A = 72.7\%$, $B = 17.6\%$ & Distance = 50 ft.

$$\text{Height} = (72.7\% + 17.6\%) \times 50'$$

$$\text{Height} = (.903) \times 50'$$

$$\text{Height} = 45.15 \text{ ft.} = 45'$$

Figure 25A

Below Object Base

$$\text{Height} = (A - B) \times \text{Distance}$$

Example: $A = 78.1\%$, $B = 17.6\%$ & Distance = 75 ft.

$$\text{Height} = (78.1\% - 17.6\%) \times 75'$$

$$\text{Height} = (.605) \times 75'$$

$$\text{Height} = 45.38 \text{ ft.} = 45'$$

Figure 25B

5 -- Strike & Dip Measurement

Strike & dip measurements are planar measurements taken when direct contact is made with the outcropping.

5.1 Strike Measurement

Strike is the direction of a line that is formed by an intersection of an imaginary horizontal plane and an inclined surface that is being measured.

1. Open both the cover and large sight until both extend in a straight line.
2. Place transit along a horizontal line on the inclined rock surface. (Fig 26)
 - Hint: Place on a writing tablet to extend the horizontal line.
3. Hold level by centering bubble in the round level.
4. Read strike angle at either the "N" or "S" tip.

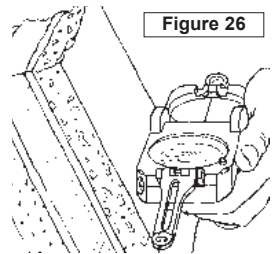

Figure 26

Some people recommend the strike measurement be the largest angle out of "N" and "S", so that there is no confusion between the strike and dip angle.

5.2 Dip Measurement

Dip is the vertical angle (inclination) of the rock surface, measured from horizontal.

1. Open the cover and large sight until they both extend in a straight line.

2. Place GEO on its side and along on the rock surface, so the vernier scale is at the bottom. (Fig 27)
3. Adjust vernier until bubble is centered in long level.
4. Read dip angle at the vernier's center line, bottom scale.

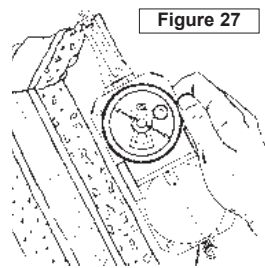

Figure 27

5.3 Dip Measurement using Hinge Inclinometer

This method uses the lid hinge inclinometer.

1. Place transit hinge next to the outcropping. (Fig 28)
2. Adjust cover to the angle of the outcropping.
3. Hold level by centering bubble in the round level.
4. Read dip angle at the hinge inclinometer scale.

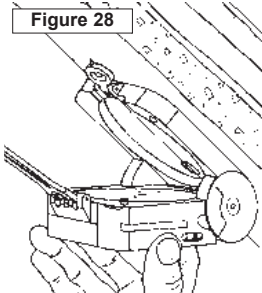

Figure 28

Hint: If the GEO transit is not in a position to view the round level, use the side/bottom long levels.

5.4 Dip Direction

After measuring dip using the hinge inclinometer, now measure the dip direction.

1. With hinge next to outcropping and GEO transit level, measure the dip direction. (Fig 28)
2. Read dip direction at the "S" tip.

6 -- Trend & Plunge Measurement

Trend and plunge are usually non-contact linear measurements, unlike strike and dip which are planar measurements. However, both methods provide similar information.

6.1 Trend Measurement

Trend is the direction that the lineation points downward (plunges).

1. Place a pen, pencil, or anything straight in the direction the lineation points down (plunges).

2. Stand on top, or behind the lineation and face the direction of the plunge.
3. Hold compass at waist level and look down through the long sight, aligning the pencil with the long sight. (Fig 29)
4. When bubble is centered in the round level, read the trend at "S" end of the needle.

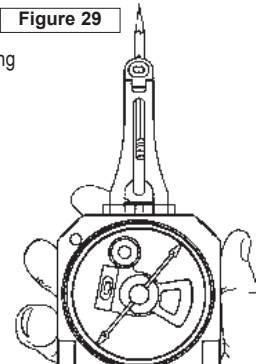

Figure 29

6.2 Plunge Measurement

Plunge is the inclination between the lineation and a horizontal line.

1. Move to the side of the lineation, or right angles to its trend.

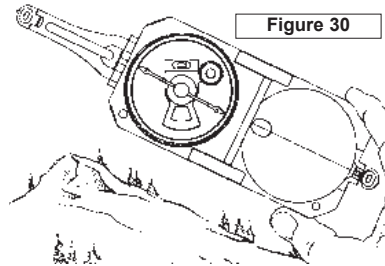

Figure 30

2. Open both the cover and large sight until they extend in a straight line.
3. Measure plunge using a Brunton non-magnetic tripod, or by holding the transit in your hand. (Fig. 30)

7 -- GEO Transit & Topographic Map Use

A United States Geological Survey (USGS) topographic map is a 2-dimensional drawing of 3-dimensional terrain. Hills, valleys, ridges, cliffs and other terrain are represented through a series of contour lines. Each line represents constant elevation in feet or meters above sea level. Find the contour interval in the legend of the topographic map. With practice, you'll begin to recognize contours, labeling and identify passable routes.

7.1 Map Azimuth

It is possible to read a map azimuth from your position to a destination. Orient your map to true north, then determine a map azimuth by using the GEO transit.

1. On a USGS topographic map, place a "point" at a starting position and an "X" at a destination.
2. Draw a line connecting both marks.
3. At the starting "point", draw a true north line. (Fig 31)
 - Use true north indicator in the legend, or the edge of printed topographic map.
4. Adjust GEO for declination.
5. With large sight pointing at true north on the map, place transit along edge of printed map.
6. Rotate map and compass until the "N" points at 0°. (Fig 31)

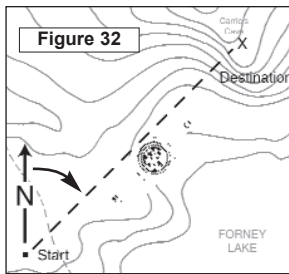
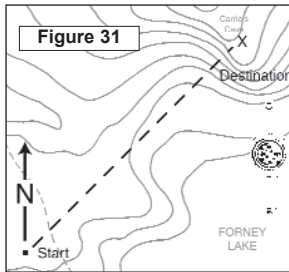

The map is aligned to true north. Now, determine the azimuth from "Start" to the "Destination".

7. Position the GEO transit so the large sight points at the destination and is next to the azimuth line. (Fig 32)
8. Read azimuth where the "N" points.

From the "Start" position in the field, sight the azimuth determined from the map, and you will be facing the "Destination". See section, 3 - Azimuth Measurement, for help.

7.2 Triangulation

Use Triangulation to find your approximate position, using the GEO and a map. Make sure the GEO is adjusted for magnetic declination.

1. Identify three landmarks in the field, that are identifiable on a topo-map.
2. Orient map to true north (see section 7.1)
3. Sight an azimuth to each landmark and mark them on the map. (Fig 33)
4. Draw a line on the map for each landmark azimuth.
5. Your position is within the small triangle, or point formed by the intersection of the three lines. (Fig 33)

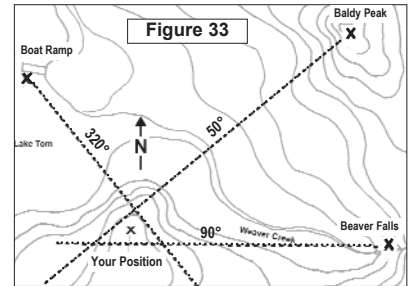

8 -- Additional Measurements

8.1 Level

The GEO transit can be used as a level, to run level lines, or to determine points of elevation.

1. Adjust Vernier to 0° inclination, using the vernier adjustment.
2. Place transit on its side, on an object, or use the tripod. (Fig 34)
3. Tilt instrument until bubble is centered in the long level.

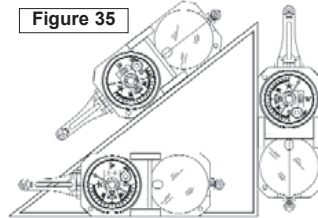
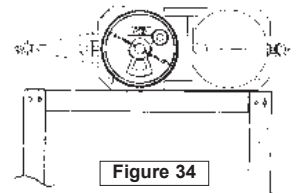

8.2 Plumb Bob

1. Suspend the transit in an open position from the large sight -- See right image figure 35.
2. Use the small sight as the pointer.

8.3 Inclinometer

1. Position GEO on its side and on top of the object with the vernier down. (Fig 35)
2. Rotate vernier adjustment until the bubble is centered in the long level.
3. Read inclination in degrees or % grade.

9 -- Prospecting

If you were to discover gold, silver, or another valuable mineral deposit, you would want to "stake a claim". It would be necessary to construct a map of your claim, and tie (locate) your claim relative to some known position. Your Brunton GEO transit is ideally suited for this job, since it is a modification of the same instrument used by geologists, mining engineers for prospecting and mapping around the world, since 1896.

9.1 Laws Governing Prospecting

In 1872 the General Mining Laws were enacted, and since then more laws have been passed governing the western United States. **Currently, state laws vary widely and the federal laws concerning mining claims are quite vague. A discussion of the law is beyond the scope of this manual and it is strongly advised that you contact your state and federal agencies for information concerning "staking a claim".**

**For a basic understanding, following is general information on mining claims.
RULES AND LAWS MAY HAVE CHANGED.**

1. **Lands Open to Mining Claims** - Lands available for mining claims can be determined by examining records from the Federal Land Office and the U.S. Bureau of Land Management (BLM), for your state. Generally, mining claims are limited to western states, where public land still exists. This includes public lands administered by the U.S. Forest Service, and U.S. BLM. It excludes national parks, monuments, state owned land and privately owned lands.
2. **Qualification** -- An individual must be a United States citizen, or one who has declared their intention to become a citizen. A corporation must be organized under the laws of the United States, or one of the fifty states. There are no restrictions as to age or residency.

3. **Federal Requirements** - The location of the claim must be distinctly marked on the ground so that its boundaries can be readily traced. All records of mining claims shall contain the name, or names of the locators, the date of the location and such a description of the claim or claims located by reference to some natural object or permanent monument as will identify the claim.
4. **State Requirements** - Each mining district may make regulations not in conflict with the laws of the United States, or with the laws of the state or territory in which the district is situated governing the location, manner of recording and amount of work necessary to hold position of a mining claim. This means the details of location are left to each state.
5. **Type of Claims** - There are four types of claims: lode claims, placer claims, mill sites, and tunnel sites. *Only lode claims are discussed here.*
6. **Lode Claims** - A lode is defined as a zone or belt of mineralized rock lying within boundaries clearly separating it from the neighboring rock. The dimensions of a lode claim are a maximum of 1,500 feet along the lode or vein, and no more than 300 feet to either side of the vein; end lines must be parallel.

Following, is an example of state regulations -- Nevada lode claim location requirements.

1. Erect a *discovery monument* at the point of discovery, and post thereon a *location notice* containing: (a) the name of the claim, (b) the name and mailing address of the locator, (c) the date of location, (d) the number of linear feet along the vein each way from the discovery monument, with the width claimed on either side of the vein, and (e) the general course of the vein. (NRS 517.010)
2. All monuments must consist of (a) a tree cut of 3 or more feet above the ground and blazed, (b) a rock pile 3 or more feet in height, or (c) a 4-inch diameter post at least 4 1/2 feet in length set 1 foot in the ground. (NRS 517.030)
3. Within 20 days of posting the location notice, mark the boundaries of the claim by placing monuments at the four corners and center of each side line. (NRS 517.030)
4. Within 90 days of posting the location notice, prepare two copies of a claim map (scale of 500 feet to the inch) showing the position of the claim monuments, the relationship of the claim monuments and the relationship of the claim group to a survey corner, or claim

location marker. The marker must be a rock pile 4 feet in diameter and 4 feet high, or a steel post 3 inches in diameter and 5 feet high. The description must also include the section, township and range. The map need not be perfect, but "in accordance with the locator's abilities." (NRS.030) The maps must then be filed with the county recorder. (NRS 517.040 (2))

5. Within 90 days of posting the location notice, record duplicate location certificates with the county recorder containing the following information *(NRS 517.050):
 - a. The name of the lode or vein.
 - b. The name of the locator or locators, together with the post office address of such locator or locators
 - c. The date of the location.
 - d. The number of linear feet claimed in length along the course of the vein each way from the point of discovery with width of each side of the center of the vein, and the general course of the lode or vein as near as may be.
 - e. A statement that the location work consisted of making the maps as provided in (NRS 517.040).
 - f. The location and description of each corner, with the markings thereon.
6. Only one location may be claimed on each location notice or location certificate (NRS 517.020, 517.050).
7. Penalty for late recording: "any record of the location of a lode mining claim which shall not contain all the requirements named in this section recorded on or after July 1, 1971, shall be void, and every location of a mining claim recorded on or after July 1, 1971, shall be absolutely void unless a certificate of location thereof substantially complying with the above requirements is recorded with the county recorder of the county in which the claim is located within 90 days after the date of location." (NRS 517.050 (2))

Other states require some form of discovery work other than preparation of a map. This may consist of digging a shaft or drilling a specified footage of discovery holes. *Check the mining statutes of the desired state to determine its specific requirements.*

9.2 Surveyed Land

In locating your mining claims and constructing your claim location map, it will be helpful to understand how lands are divided up by the rectangular system of surveys. This system is the basis for the identification, administration and disposal of public lands.

Figure 35 illustrates how lands are divided by survey. Lines running north-south are called range lines. R22E stands for Range 22 East of the principal meridian. Lines running east-west are township lines. T22S stands for Township 22 South of the base line. On a topo-map, the range lines are shown at the top and bottom of the printed map. Township lines are shown on the east-west margin of the map. By specifying the township and range, a township area of land is located. The large squares in figure 27 are townships. For example, T22S, R22E specifies the township area with 36 sections, each numbered and 1 mi² (640 acres) apiece. This makes a township is 36 mi². A 1mi² section of land is located by calling out the section number, township and range -- Section 4, T22S, R22E.

A section is further divided into quarter sections by straight lines connecting quarter section corners or opposite boundaries. There are eight monuments on each section. One monument on each corner and one midway between corners on the section boundary lines (not shown).

If your claim is in a surveyed area of public land, it will be located within a section shown on a topo-map. To locate your claim, it is then necessary to tie, or locate your claim relative to a section corner monument. The corner monument may be a pipe with a brass cap fastened to the top. It may be a brass tablet. 3 1/4 by 3 1/2 inches, attached to a rock outcropping and

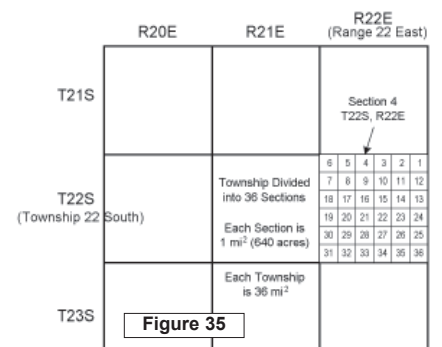

set in concrete. The brass is marked with letters and figures that give the section, township and range. It is marked so that it must be read while standing on the south side of the monument. The south side of the monument is marked with the date of the monument. (Fig 36)

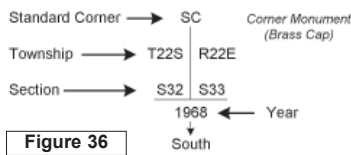

Figure 36

9.3 Sample Claim Location Map

Figure 37 shows the location monument with claim extending 300 feet to each side of the vein center line and 1,500 feet long. The claim is tied or located to a section corner post by showing the bearing to the corner post, the number of feet to the post and the section, township and range.

Obtain a bearing selecting one of your claim corners as your tie point, and sighting from the tie point to the section corner post. The azimuth to the South East corner of Section 32, T22S, R22E was found to be 110°. (Fig 37) Note, the distance to the section corner must also be provided.

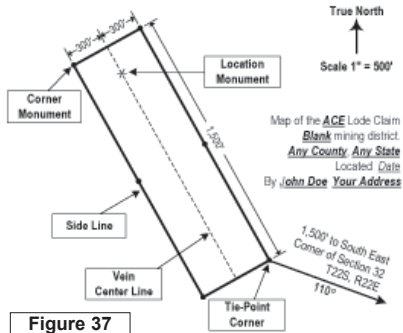

Figure 37

9.4 Location On Unsurveyed Land

Not all of the U.S. has been surveyed. As of 1970, about 500,000,000 acres were still unsurveyed. Most of the unsurveyed land is located in mountainous sections of the country. Since then, however, more has been surveyed. Check with the Federal Land office, or the U.S. Bureau of Land Management of your state.

If your claim is located in one of the

unsurveyed areas (no corner post to locate, or tie your claim), you must locate your claim in reference to some natural land mark. A natural land mark being a mountain top, intersection of a river and a stream, etc.

9.4.a Using Bearing & Distance

Figure 38 shows a claim tied to Blue Mountain Peak by an azimuth of 81°, and a distance to Blue Mountain Peak of 7,000 feet from a corner monument.

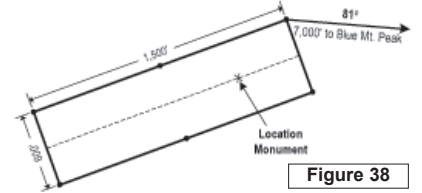

Figure 38

9.4.b Using Two Bearings

The claim in figure 39 is tied to two azimuth readings from a corner monument. Using this method, distance is not required, since the intersection of both azimuth lines determine the location.

9.4.c Using Five Bearings

For a more complete description of your

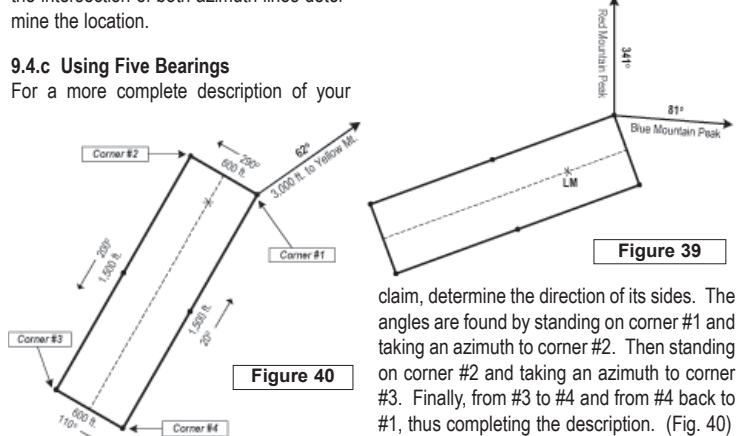

Figure 40

Figure 39

claim, determine the direction of its sides. The angles are found by standing on corner #1 and taking an azimuth to corner #2. Then standing on corner #2 and taking an azimuth to corner #3. Finally, from #3 to #4 and from #4 back to #1, thus completing the description. (Fig. 40)

A description of the claim, shown in Figure 40, would read:

Beginning at Corner #1, NE corner: Thence 600 feet, 290° to Corner #2. Thence 1,500 feet, 200° to Corner #3. Thence 600 feet, 110° to Corner #4. Thence 1,500 feet, 10° to Corner #1.

10 -- Reference Materials

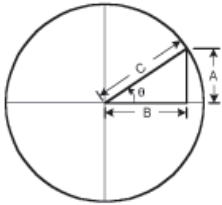

$$\begin{aligned} \text{SIN}(\theta) &= A/C & \text{CSC}(\theta) &= C/A \\ \text{COS}(\theta) &= B/C & \text{SEC}(\theta) &= C/B \\ \text{TAN}(\theta) &= A/B & \text{COT}(\theta) &= B/A \end{aligned}$$

A = Side opposite angle θ
B = Side adjacent to angle θ
C is the hypotenuse
 $C^2 = A^2 + B^2$

Inches	Feet	mm	cm	Conversions	Conversions
1/8	0.0104	3.1750	.31750	1 inch = 2.54 centimeters	1 centimeter = 10 millimeters
1/4	0.0208	6.3500	.63500	1 foot = 12 inches	1 centimeter = 0.01 meters
3/8	0.0313	9.5250	.95250	1 foot = 0.305 meters	1 centimeter = 0.394 inches
1/2	0.0417	12.700	1.2700	1 yard = 3 feet	1 meter = 100 centimeters
5/8	0.0521	15.875	1.5875	1 yard = 0.914 meters	1 meter = 3.281 feet
3/4	0.0625	19.050	1.9050	1 chain = 66 feet	1 meter = 1.094 yards
7/8	0.0729	22.225	2.2225	1 mile = 5,280 feet	1 kilometer = 1,000 meters
1	0.0833	25.400	2.5400	1 mile = 80 chains	1 kilometer = 0.6214 miles
2	0.1667	50.800	5.0800	1 mile = 1.609 kilometers	1 hectare = 10,000 meters ²
3	0.2500	76.200	7.6200	1 acre = 43,500 feet ²	1 hectare = 2.471 acres
4	0.3333	101.60	10.160	1 acre = 0.4047 hectares	
5	0.4167	127.00	12.700		
6	0.5000	152.40	15.240		
12	1.0000	304.80	30.480		

11 -- Specifications

Specifications include Brunton model 5009 & 5010 GEO transits.

Magnetism: NdFeB Magnet (rare earth magnet)
 Accuracy: Bearing -- +/- 1/2° accurate
 Inclination -- +/- 1° accurate (30 minute readable)
 Size (Closed): Length -- 9.45 cm (3.72 in.)
 Width -- 7.06 cm (2.78 in.)
 Height -- 3.43 cm (1.35 in.)
 Weight -- 289 g (10.2 oz.)

12 -- Service

Engraving - Personalize the Brunton GEO Transit with engravings (up to 18 characters, including spaces). Call Brunton at (307) 856-6559 for details.

Balancing - Brunton GEO transits must be balanced for use in specific regions of the world. If using the GEO outside North America, the GEO's needle may need to be balanced. Call Brunton at (307) 856-6559 for details.

Repair / Service - Brunton's repair department is capable of handling repairs, or conversions of any genuine Brunton Pocket, or GEO transits. Periodic maintenance and calibration is highly recommended and will prolong the life of your pocket transit. Call Brunton at (307) 856-6559 for details.