

# Circulating Baths with Advanced Digital Temperature Controller

## Operator's Manual

### Models:

AD07R-20  
AD07R-40  
AD7LR-20  
AD15R-30  
AD15R-40  
AD20R-30  
AD28R-30  
AD45R-20  
AD07H200  
AD15H200  
AD20H200  
AD28H200  
AD06S150  
AD10S150  
AD28S150  
AD29VB3S  
AD29VB5R



110-513 PSC/EN 17 November 2014

# Table of Contents

<b>Introduction</b> .....	<b>4</b>
PolyScience Circulating Baths with the Advanced Digital Temperature Controller .....	4
General Safety Information.....	5
Safety Recommendations.....	6
Regulatory Compliance & Testing .....	7
Unpacking Your Circulator.....	8
Contents .....	8
Controls & Components.....	9
Advanced Digital Controller .....	9
Refrigerating/Heating Baths .....	10
Heating Only Baths.....	11
Open Bath Systems (Stainless Steel) .....	12
Viscosity Bath (Polycarbonate) .....	12
<b>Quick-Start</b> .....	<b>13</b>
<b>Installation &amp; Startup</b> .....	<b>15</b>
General Site Requirements .....	15
Adding Liquid to the Bath Reservoir .....	15
Pump Inlet and Outlet Connections .....	16
External Closed Loop Circulation .....	17
Open Loop Circulation .....	17
Refrigeration Control Connections (Refrigerating/Heating Circulators only) .....	18
Electrical Power .....	18
Refrigerating/Heating Circulators .....	18
Heat Only Circulators and Open Bath Systems .....	19
Communication.....	20
USB Communication .....	21
Ethernet.....	21
RS232 / RS485 Serial Communication .....	21
External (P2) Temperature Probe .....	21
Controller Setup .....	22
Power .....	22
Safety Set Temperature .....	23
<b>Normal Operation</b> .....	<b>24</b>
Keys and Controls .....	24
Turning Your Circulator ON .....	24
Main Operational Display.....	25
Set-Up Sub-Menus .....	27
Adjusting the Temperature Set Point.....	28
Selecting the Temperature Unit.....	29
Selecting the Pump Speed .....	30
Setting the High Limit Temperature.....	31
Setting the Low Limit Temperature.....	32
Setting the Differential Temperature.....	33
Setting the Auto Cool Temperature .....	34
Setting the Specific Heat Capacity (SHC) .....	35
Selecting Internal or External Control.....	36
Calibrating Your Circulator (Offset) .....	37
Displaying the Safety Set Temperature.....	38
Selecting a Remote Communication and Control Protocol .....	39
Using the Timer .....	40
Entering a Password.....	41
Enabling / Disabling Data Logging .....	42

Selecting the Operational Language .....	43
Setting Auto Restart.....	44
Resetting the Factory Default Values .....	44
Changing Your Circulator's Viewing Angle.....	45
Inert Gas Purge .....	45
Tap Water Cooling.....	45
Reservoir Cover Storage .....	46
<b>Display Messages and Alarms .....</b>	<b>47</b>
<b>Routine Maintenance &amp; Troubleshooting.....</b>	<b>48</b>
Maintaining Clear Bath Water.....	48
Draining the Bath Reservoir .....	48
Refrigerated / Heating and Heat only Circulating Baths.....	48
Polycarbonate Viscosity Baths .....	49
Checking the Over-Temperature / Low Liquid Level Safety Systems.....	50
Over-Temperature Protection.....	50
Low Liquid-Level Protection .....	50
Cleaning Your Circulator.....	51
Temperature Controller .....	51
Bath Reservoir .....	51
Pump Impeller .....	51
Condenser, Air Vents, and Reusable Filter (Refrigerating / Heating Circulators only) .....	51
Temperature Controller Removal and Re-Installation .....	52
Removal .....	52
Re-Installation.....	53
Viewing Component Operating Time.....	54
Troubleshooting Chart .....	55
<b>Technical Information.....</b>	<b>57</b>
Performance Specifications .....	57
Reservoir Fluids .....	58
Application Notes.....	60
Tubing and Fitting Temperature Ranges.....	60
Fluid Compatibility .....	60
RS232/RS485 Configuration .....	61
RS232/RS485 Communications.....	63
USB Data Logging .....	65
USB B Setup, Monitoring, and Control .....	65
Initial Setup.....	65
Monitoring and Control .....	66
Configuring the Ethernet Connection .....	66
Direct Computer to Controller Configuration .....	66
Wired or Wireless Network Configuration .....	66
<b>Equipment Disposal (WEEE Directive) .....</b>	<b>70</b>
<b>Replacement Parts &amp; Accessories.....</b>	<b>71</b>
<b>PolyScience Circulating Bath Fluids .....</b>	<b>73</b>
<b>Service &amp; Technical Support .....</b>	<b>73</b>
<b>Warranty.....</b>	<b>74</b>

## Introduction

Thank you for choosing a PolyScience Circulating Bath. It is intended for the precise temperature control of suitable liquids in a reservoir. Extremely easy to use and maintain, your Circulating Bath combines design innovation with highly intuitive operation to deliver convenient and reliable liquid temperature control for a wide range of applications.

	<b>WARNING:</b> PolyScience Circulating Baths are not intended for directly controlling the temperature of foods, pharmaceuticals, medicines, or other objects which may be ingested by or injected in humans or animals. Any such objects must be isolated from contact with the bath fluid and bath surfaces.
---	---

Here are some of the features that make your Circulating Bath so user-friendly:

- Simple, intuitive operation
- Extra-large digital readout that displays actual and set point temperature simultaneously
- Powerful variable speed duplex pump with open- and closed-loop external circulation capability
- 180° viewing radius (Swivel 180™ rotating control head)
- DuraTop™ heat and chemical resistant top plate
- LidDock™ self-storing reservoir cover (integrated baths only)
- Built-in temperature protection
- Suitable for use with Class III flammable fluids per DIN 12876-1

It will take you very little time to get your new Circulating Bath installed and running. This Operator's Manual is designed to guide you quickly through the process. We recommend that you read it thoroughly before you begin.

### PolyScience Circulating Baths with the Advanced Digital Temperature Controller









Model Type	Reservoir Capacity	Temperature Range	
		°C	°F
AD07R-20 Refrigerating / Heating Bath	7 liters	-20° to 200°C	-4° to 392°F
AD07R-40 Refrigerating / Heating Bath	7 liters	-40° to 200°C	-40° to 392°F
AD7LR-20 Refrigerating / Heating Bath	7 liters	-20° to 200°C	-4° to 392°F
AD15R-30 Refrigerating / Heating Bath	15 liters	-30° to 200°C	-22° to 392°F
AD15R-40 Refrigerating / Heating Bath	15 liters	-40° to 200°C	-40° to 392°F
AD20R-30 Refrigerating / Heating Bath	20 liters	-30° to 200°C	-22° to 392°F
AD28R-30 Refrigerating / Heating Bath	28 liters	-30° to 200°C	-22° to 392°F
AD45R-20 Refrigerating / Heating Bath	45 liters	-25° to 135°C	-13° to 275°F
AD07H200 Heating Only Bath	7 liters	Ambient +10° to 200°C	Ambient +20° to 392°F
AD15H200 Heating Only Bath	15 liters	Ambient +10° to 200°C	Ambient +20° to 392°F
AD20H200 Heating Only Bath	20 liters	Ambient +10° to 200°C	Ambient +20° to 392°F
AD28H200 Heating Only Bath	28 liters	Ambient +10° to 200°C	Ambient +20° to 392°F
AD06S150 Open Bath System	6 liters	Ambient +10° to 150°C <sup>(1)</sup>	Ambient +20° to 302°F <sup>(1)</sup>
AD10S150 Open Bath System	10 liters	Ambient +10° to 150°C <sup>(1)</sup>	Ambient +20° to 302°F <sup>(1)</sup>
AD20S150 Open Bath System	20 liters	Ambient +10° to 150°C <sup>(1)</sup>	Ambient +20° to 302°F <sup>(1)</sup>
AD28S150 Open Bath System	28 liters	Ambient +10° to 150°C <sup>(1)</sup>	Ambient +20° to 302°F <sup>(1)</sup>
AD29VB5R Polycarbonate Viscosity	29 liters	Ambient +10° to 85°C <sup>(2)</sup>	Ambient +20° to 185°F <sup>(2)</sup>
AD29VB3S Polycarbonate Viscosity	29 liters	Ambient +10° to 85°C <sup>(2)</sup>	Ambient +20° to 185°F <sup>(2)</sup>

1. Maximum operating temperature at which  $\pm 0.01^\circ\text{C}$  temperature stability can be maintained; Advanced Digital Controller is capable of higher temperatures.

2. Maximum operating temperature for polycarbonate tank. Advanced Digital Controller is capable of higher temperatures.

## General Safety Information





When installed, operated, and maintained according to the directions in this manual and common safety procedures, your Circulating Bath should provide safe and reliable temperature control. Please ensure that all individuals involved in the installation, operation, or maintenance of this Circulating Bath read this manual thoroughly prior to working with the unit.

	This symbol alerts you to a wide range of potential dangers.
	This symbol advises you of danger from electricity or electric shock.
	This symbol indicates that a hot surface may be present.
	This symbol marks information that is particularly important.
	This symbol indicates alternating current.
	These symbols on the Power Switch / Circuit Breaker indicate that they place the main power supply ON / OFF.
	This symbol on the Power Key indicates that it places the unit in a standby mode. It DOES NOT fully disconnect the unit from the power supply.
	This symbol indicates a protective conductor terminal.

**Read all instructions pertaining to safety, set-up, and operation.  
Proper operation and maintenance is the user's responsibility.**

## Safety Recommendations

To prevent injury to personnel and/or damage to property, always follow your workplace's safety procedures when operating this equipment. You should also comply with the following safety recommendations:



	<p><b>WARNING:</b></p> <ul style="list-style-type: none"> <li>This Circulating Bath is suitable for use with Class III flammable fluids per DIN 12876-1. A fire hazard may be present.</li> <li>Be aware of the chemical hazards that may be associated with the bath fluid used. Observe all safety warnings for the fluids used as well as those contained in the material safety data sheet.</li> <li>Explosive gas mixtures may accumulate if used with insufficient ventilation. Use this Circulating Bath in a well ventilated area or beneath a suitable fume hood only.</li> <li>Use only recommended bath fluids; see <i>Technical Information</i> in the rear of this manual for recommended fluids.</li> <li>Use only non-acid bath fluids.</li> </ul> <p><b>WARNING:</b> When using Class III flammable fluids per DIN 12876-1, the user must attach the following warning labels to the front of the unit so that they are well visible:</p>		
	<p><b>Warning Label</b> W09 Colors: Yellow/black</p>		<p><b>Danger Area.</b> <b>Attention! Observe instructions (operating manual, safety data sheet)</b></p>
<p><b>Mandatory Label</b> M018 Colors: Blue/white</p> <p>or</p> <p>Semi S1-0701 Table A1-2 #9 Colors: Blue/white</p>	  	<p><b>Carefully read the user information prior to beginning operation.</b> Scope: EU</p> <p><b>Carefully read the user information prior to beginning operation.</b> Scope: NAFTA</p>	

	<p><b>WARNING:</b></p> <ul style="list-style-type: none"> <li>Always connect the power cord on this Circulator to a grounded (3-prong) power outlet. Make certain that the outlet is the same voltage and frequency as your unit.</li> <li>Never operate the Circulator with a damaged power cord.</li> <li>Always turn the Circulator OFF and disconnect mains power before performing any maintenance or service.</li> </ul>
---	--

	<p><b>WARNING:</b></p> <ul style="list-style-type: none"> <li>Never operate the Circulator without bath fluid in the reservoir. Periodically check the reservoir to ensure that the liquid depth is within acceptable levels. Always refill the reservoir using the same bath fluid type that is already in the reservoir. Bath oil must not contain any water contaminants and should be preheated to the actual bath temperature before adding as there is an explosion hazard at high temperatures.</li> <li>Always drain all fluid from the reservoir before moving or lifting your Circulator. Be sure to follow your organization's procedures and practices regarding the safe lifting and relocation of heavy objects.</li> </ul>
---	---

	<p><b>WARNING:</b></p> <ul style="list-style-type: none"> <li>• Always allow the bath fluid to cool to ambient temperature before draining.</li> <li>• The reservoir cover, top deck, and/or external pump connections may become hot with continuous use. Exercise caution when touching these parts.</li> <li>• Always keep within the 85°C maximum operating temperature limit if using a polycarbonate tank.</li> </ul>
	<p><b>WARNING:</b> It is the user's responsibility to properly decontaminate the unit in the event hazardous materials are spilled on exterior or interior surfaces. Consult manufacturer if there is any doubt regarding the compatibility of decontamination or cleaning agents.</p>

## Regulatory Compliance and Testing

This equipment is compliant with the European Directive 2002/95/EC and its latest amendments on Restrictions on Hazardous Substances (RoHS) and below the given limits of hazardous substances.

### ETL Intertek (60 Hz units)

UL 61010-1 / CSA C22.2 No. 61010-1 — Safety Requirements for Measurement, Control, and Laboratory Use; Part 1: General Requirements

UL 61010A-2-010 / CSA C22.2 No. 61010-2-010:04 — Safety Requirements for Measurement, Control, and Laboratory Use; Part 2-010: Particular Requirements for Laboratory Equipment for the Heating of Materials

UL 61010A-2-051 / CSA C22.2 No. 61010-2-051:04 — Safety Requirements for Measurement, Control, and Laboratory Use; Part 2-051: Particular Requirements for Laboratory Equipment for the Mixing and Stirring

### CE (all units)

EC Low Voltage Directive 2006/95/EC

EC Electromagnetic Compatibility Directive 2004/108/EC

IEC 61010-1-2001

IEC 61010-2-2001

IEC 61326:2005 / EN 61326 : 2006

## Unpacking Your Circulator

Your Circulator was packed in a special carton or cartons. You should keep the packaging, along with all packing materials, until the unit has been installed and you are certain it is working properly.

	<p><b>CAUTION:</b> Remove any loose packing material that may have fallen into the heater/pump housing during shipping. Before powering up, check that nothing remains around the heater or Circulator pump.</p>
---	--

We recommend that you begin using your Circulator immediately to confirm proper operation, since beyond one week you may be eligible for warranty repair only (rather than replacement). You'll find complete warranty information in the back of this manual.

In the unlikely event that the unit was damaged or does not operate properly, contact the transportation company, file a damage claim, and contact the company where your Circulator was purchased.

## Contents

The items included with your Circulator will vary depending on which model Circulating Bath you purchased.

	Refrigerating / Heating Bath	Heating Only Bath	Open Bath System	Viscosity Bath
Resource Disk with Operator's Manual	•	•	•	•
Reservoir Lid	•	•	•	N/A
3-ft / 0.91 m IEC to IEC Power Cord	•	N/A	N/A	N/A
6-ft / 1.82 m IEC to Mains Power Cord	•	•	•	•
Refrigeration Control Cable	•	N/A	N/A	N/A
Fittings	1/4 in. NPT to 3/16 in. barbed adapter <sup>(1)</sup> 1/4 in. NPT to 1/4 in. barbed adapter <sup>(1)</sup> 1/4 in. NPT to 3/8 in. barbed adapter <sup>(1)</sup> 1/4 in. NPT to M16 barbed adapter <sup>(2)</sup>			
Cooling Coil	N/A	Integral	Optional	•
Certificate of Compliance	•	•	•	•
Quick-Start Guide	•	•	•	•

1. 60Hz and 50Hz models

2. 50Hz models only



## Controls and Components

### Advanced Digital Controller



## Refrigerating/Heating Baths

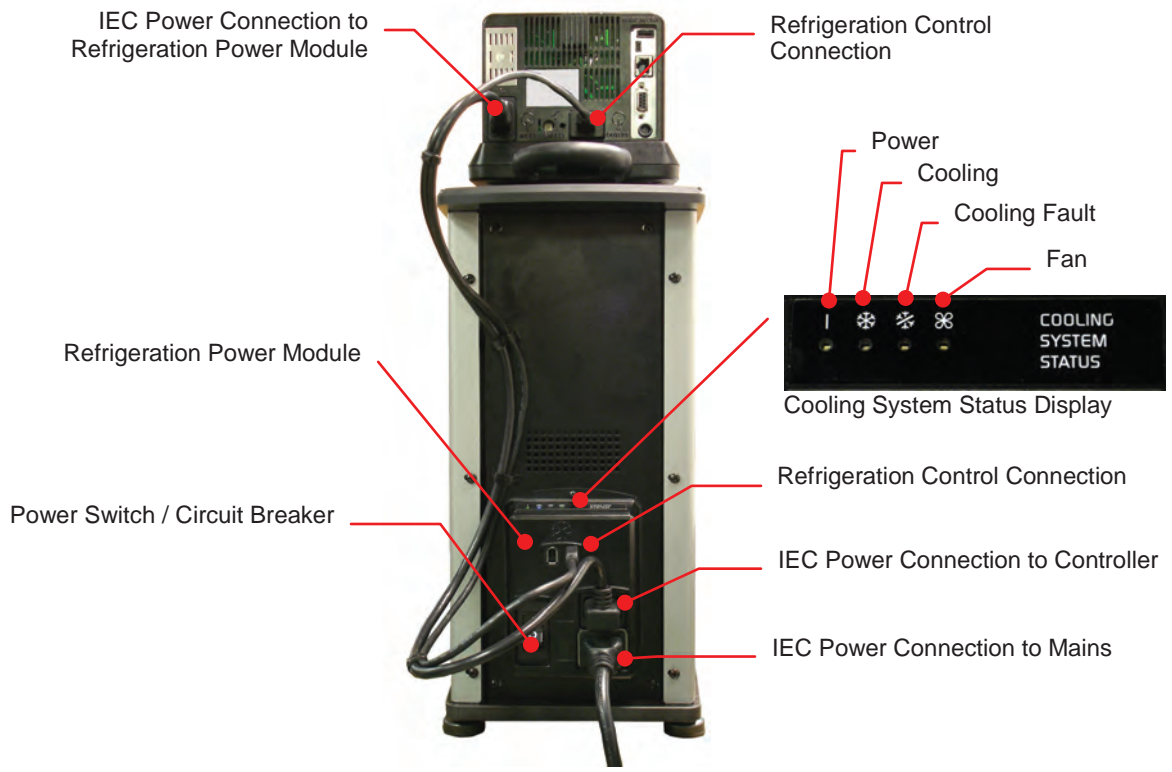

## Heating Only Baths

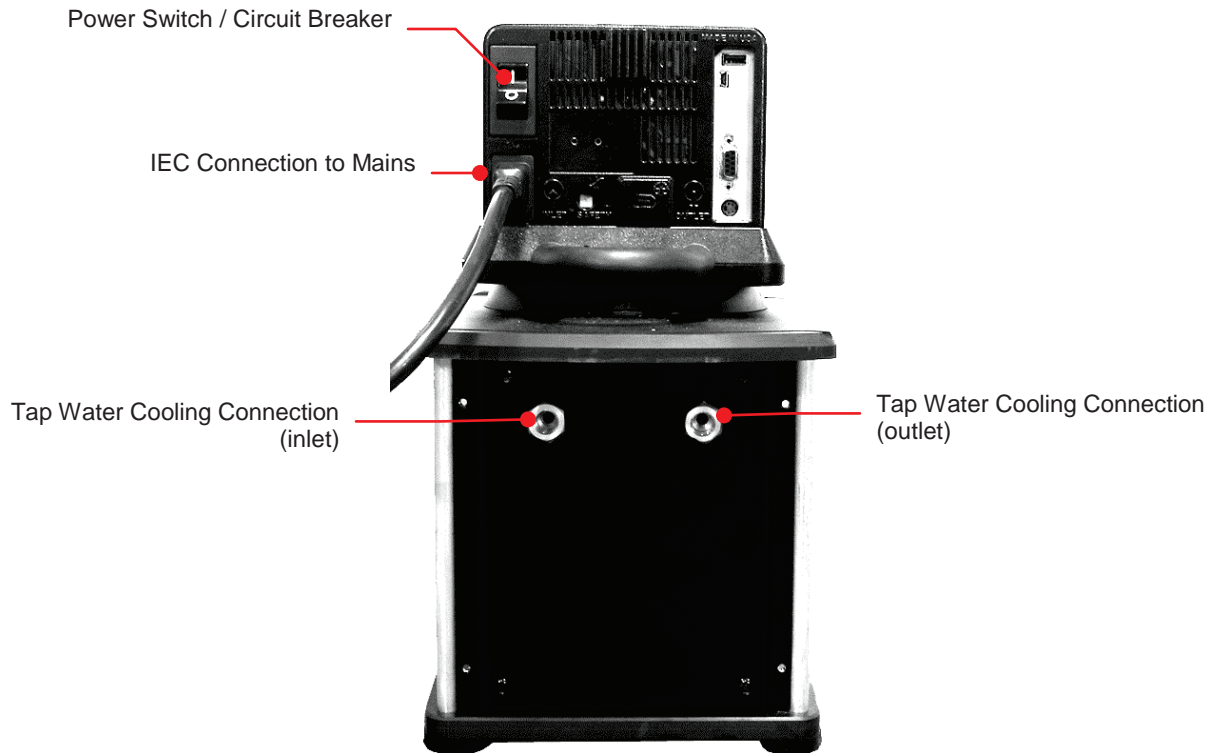

### Open Bath Systems (Stainless Steel)





### Viscosity Bath (Polycarbonate)



	<p><b>WARNING:</b> The top deck on Open Bath Systems and Viscosity Baths is not attached. Do not remove deck while Circulator is operating. Do not lift bath by grasping the Temperature Controller or top deck. Always disconnect electrical power and drain fluid from bath before moving.</p>
	<p><b>WARNING:</b> The PolyScience Advanced Digital Temperature Controller is designed for use with Class III flammable liquids per DIN 12876-1; however, we strongly recommend that Open Bath Systems and Viscosity Baths be used only with non-flammable fluids.</p>
	<p><b>WARNING:</b> To avoid the potential for burns, allow the Circulator to cool completely before cleaning or performing any maintenance.</p>

## Quick-Start

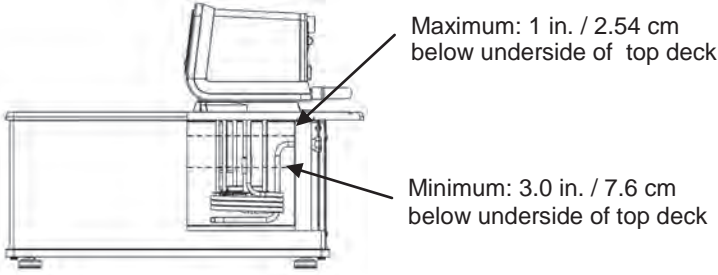
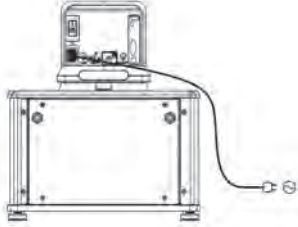
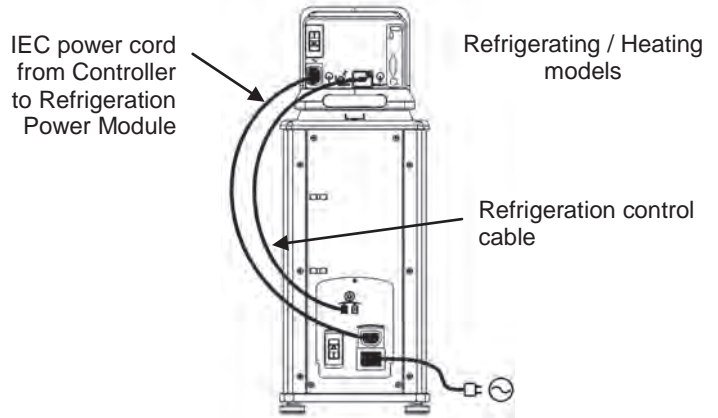
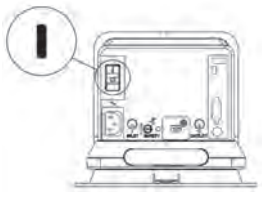
Unless otherwise specified, quick-start instructions apply to all models. See Installation and Startup for additional information.

<p>1</p>	<p>Fill reservoir with fluid</p>	
<p>2</p>	<p>Connect all power cords and control cables</p>	<div style="display: flex; justify-content: space-between;"> <div data-bbox="686 688 998 934">  <p>Heating only models</p> </div> <div data-bbox="686 961 1399 1375">  <p>IEC power cord from Controller to Refrigeration Power Module</p> <p>Refrigerating / Heating models</p> <p>Refrigeration control cable</p> </div> </div>
<p>3</p>	<p>Place Power Switch / Circuit Breaker in ON position</p>	<div style="display: flex; justify-content: space-between;"> <div data-bbox="787 1423 1047 1627">  <p>Heating only models</p> </div> <div data-bbox="868 1648 1399 1816">  <p>Refrigerating / Heating models</p> </div> </div>

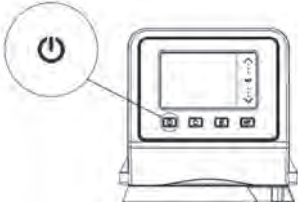
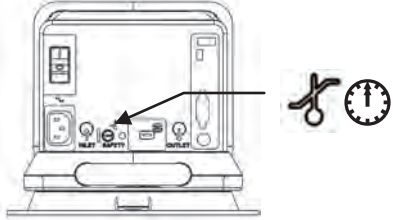
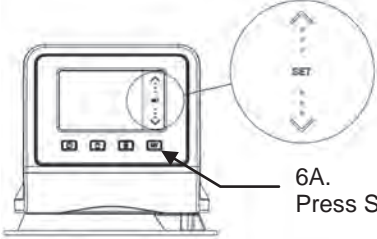
4	Turn Controller "ON"	
5	Set safety thermostat	
6	Enter temperature set point	 <p data-bbox="1133 779 1403 856">6B. Touch and hold or slide finger up/down scroll bar</p> <p data-bbox="971 905 1089 953">6A. Press SET</p>

## Installation and Startup

Your Circulating Bath with Advanced Digital Temperature Controller is designed to be simple to set-up and install. The only tools required are a No.1 Phillips-head screwdriver and a container for adding water or other suitable fluid to the bath reservoir.





### General Site Requirements

Locate your Circulator on a level surface free from drafts and direct sunlight. Do not place it where there are corrosive fumes, excessive moisture, high room temperatures, or in excessively dusty areas.

Refrigerating / Heating Circulators must be 10.2 cm / 4 inches or more away from walls or vertical surfaces so that airflow is not restricted.

Avoid voltage drops by using properly grounded power outlets wired with 14 gauge or larger diameter wire and if possible, be close to the power distribution panel. The use of extension cords is not recommended; this will reduce the potential for problems caused by low line voltage.

### Adding Liquid to the Bath Reservoir

	<p><b>WARNING:</b> When using Class III flammable fluids per DIN 12876-1, the user must attach the following warning labels to the front of the unit so that they are well visible:</p>		
	<p><b>Warning Label</b> W09 Colors: Yellow/black</p>		<p><b>Danger Area.</b> <b>Attention! Observe instructions (operating manual, safety data sheet)</b></p>
	<p><b>Mandatory Label</b> M018 Colors: Blue/white</p> <p>or</p> <p>Semi S1-0701 Table A1-2 #9 Colors: Blue/white</p>	  	<p><b>Carefully read the user information prior to beginning operation.</b> Scope: EU</p> <p><b>Carefully read the user information prior to beginning operation.</b> Scope: NAFTA</p>
	<p><b>WARNING:</b> See <i>Technical Information</i> in the rear of this manual for a list of compatible liquids.</p> <p><b>WARNING:</b> Read the safety data sheet for the bath fluid being used carefully before filling reservoir.</p> <p><b>WARNING:</b> If the proper fluid level is not maintained, the heater coil may become exposed and possibly damaged (fluid level too low) or the bath may overflow (fluid level too high).</p>		

The liquid in the reservoir should be maintained at a depth between 1 inch / 2.54 cm and 3.0 inches / 7.6 cm below the underside of the bath's top deck. Upon start up, it may be necessary to add fluid to the bath to compensate for the fluid required for external circulation. Likewise, be sure to compensate for fluid displacement when placing samples or other materials in the Circulator's reservoir.

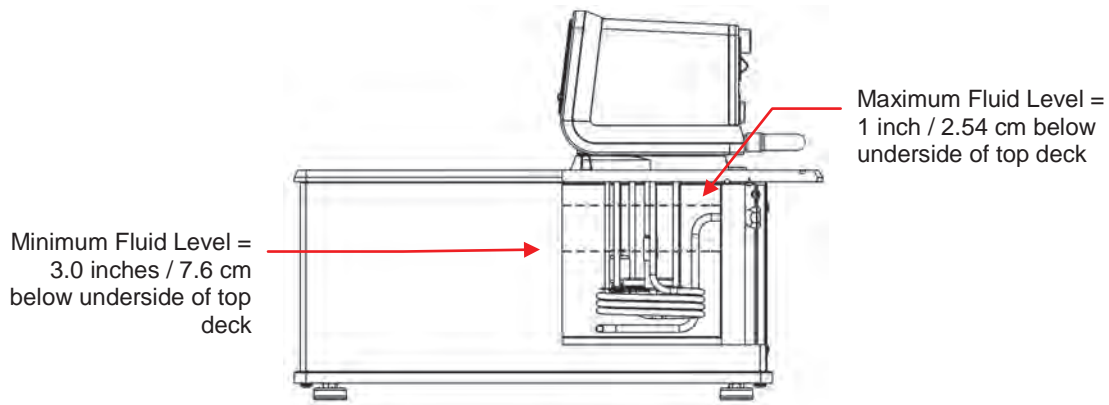

	<b>WARNING:</b> Always drain all fluid from the reservoir before moving or lifting your Circulator. Be sure to follow your organization's procedures and practices regarding the safe lifting and relocation of heavy objects.
--	--

	<b>WARNING:</b> To avoid the potential for burns, allow the Circulator to cool completely before cleaning or performing any maintenance.
--	--

### Pump Inlet and Outlet Connections

	<p><b>WARNING:</b> When connecting tubing to an external application, it is the user's responsibility to make sure that the tubing and fittings connected to the Circulator are suitable for the fluid being used and the temperature range of operation.</p> <p><b>CAUTION:</b> The Circulator's bypass tubing is secured to the fluid inlet and outlet connections by high temperature nylon hose clamps, which can be removed by carefully cutting them with diagonal cutters.</p> <p><b>CAUTION:</b> Secure the tubing to the inlet and outlet fittings using hose clamps with a minimum ID of 7/8 inch (22 mm). Do not operate the unit without hose clamps.</p>
--	---

	<b>WARNING:</b> If the Circulating Bath will not be used for external circulation, the inlet and outlet ports should remain connected using the Buna N bypass tubing provided with the unit.
--	--

The pump inlet and outlet ports are female ¼ inch NPT connections that permit use of barbed tubing adapters or hard plumbing fittings. ½ inch (13 mm) ID tubing may also be slid over these connections and held in place with a hose clamp (minimum 7/8 inch / 22 mm ID).

If the pump inlet and outlet are not used for external circulation, the Bypass Tubing provided with the unit should be left in place in order to optimize fluid mixing within the reservoir.

The nylon barbed tubing adapter fittings supplied with the unit are intended for applications from -40° to 93°C. For applications above 93°C, brass, stainless steel, or Teflon® fittings are recommended. ¼ inch NPT to M16 stainless steel male adapter fittings are provided with all 50Hz models.

	<b>NOTE:</b> The use of quick-connect fittings is not recommended as they typically restrict flow rate.
--	---



## External Closed Loop Circulation

Connect the pump inlet and outlet to the external apparatus. To maintain adequate flow, avoid restrictions in the tubing. When connecting the Circulator to more than two closed loops, the use of a manifold made of “Y” adapters to divide the fluid into multiple banks is recommended. After setting up multiple closed loops, check for adequate flow at the return manifold of each loop and check that the bath fluid is at an adequate level. A booster pump may be added to closed loops without damaging the Circulator’s pump.

The temperature control stability of a closed loop system is better at the external apparatus than in the Circulator reservoir (provided the control point of the apparatus represents a constant load and is well insulated). For example, if you circulate fluid through a viscometer at 50°C, the temperature variation observed in the Circulator reservoir may be  $\pm 0.1^\circ\text{C}$  while the temperature variation in the viscometer may be only  $\pm 0.05^\circ\text{C}$ .

Although temperature stability is generally better at the external apparatus control point, depending on the length of tubing used and the efficiency of the insulation, the actual temperature reading at the external apparatus may be slightly different than the temperature reading at the Circulator reservoir.

## Open Loop Circulation

The duplex (pressure/suction) pump permits circulation to and from an external open bath. To prevent siphoning when the Circulating Bath is turned off, position both baths so that the two fluid levels are at the same elevation.

Connect the pump inlet and outlet to the external bath using tubing of the same diameter and length. The same size fittings should also be used on both the inlet (suction) and outlet (pressure). This helps ensure a balanced flow. A restricting valve or pinch clip should be installed in the pressure (outlet) tubing and adjusted to match the return suction (inlet) flow rate. Cut the external end of the suction tube into a “V” shape so that the tube will not seal itself against the wall of the external tank. Both the pressure and suction tubing should be securely fastened to the external tank to prevent movement during use.

When using flexible tubing, the suction tubing must have a wall thickness that will not collapse under vacuum, particularly when going around bends.

Circulating Bath Height Regulation — Position the ends of the pressure and suction tubes at the desired maximum fluid level in the external bath and fill the bath to that level. Fill the Circulating Bath to a height one inch (25mm) below the top of the reservoir. Start the pump and adjust the restricting valve/pinch clip on the pressure tubing until the liquid height in both baths remains constant. Add fluid to the baths as needed to compensate for the fluid in the inlet and outlet lines.

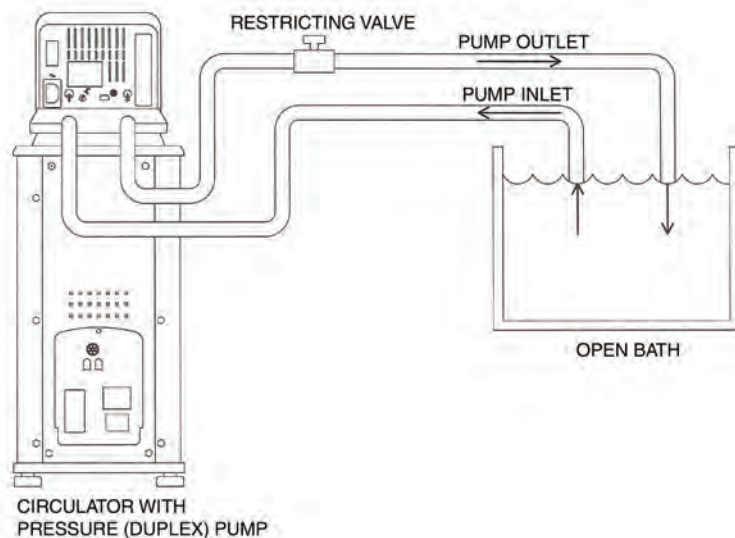

## Refrigeration Control Connections (Refrigerating/Heating Circulators only)

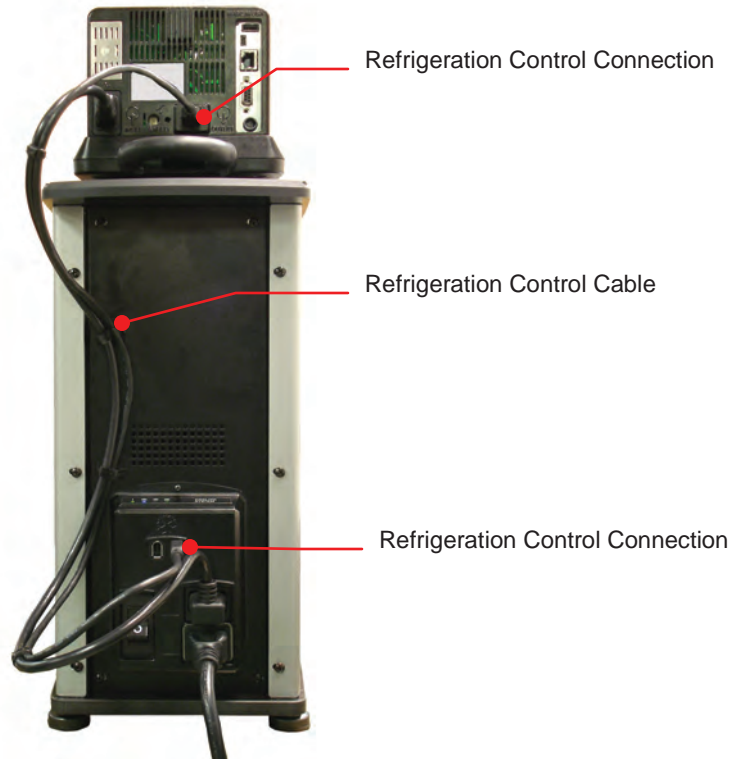

### Electrical Power

	<b>WARNING:</b> The Circulator's power cord must be connected to a properly grounded electrical receptacle. Make certain that this electrical outlet is the same voltage and frequency as your Circulator. The correct voltage and frequency for your Circulator are indicated on the identification label on the back of the Controller.
---	---

	<b>CAUTION:</b> The use of an extension cord is not recommended. If one is necessary, it must be properly grounded and capable of handling the total wattage of the unit. The extension cord must not cause more than a 10% drop in voltage to the unit.
---	--

### Refrigerating / Heating Circulators

Attach the 3-ft / 0.91 m power cord to the IEC electrical connectors on the Temperature Controller (male) and the Refrigeration Power Module (female).

Attach the 6-ft / 1.8 m power cord to the IEC electrical connection on the Refrigeration Power Module and then plug the male connector into the Mains electrical outlet.

Place the Power Switch / Circuit Breaker on the Refrigeration Power Module in the ON position. The LCD on the Controller will light and "Standby" will appear on the display; the PolyScience logo and the Power Key will also light.

	<b>NOTE:</b> To conserve power when not in use, the LCD's backlighting will go out about 5 seconds after "Standby" appears. The Power Key and PolyScience logo will remain lit to indicate that the Controller is energized and ready to use.
---	---

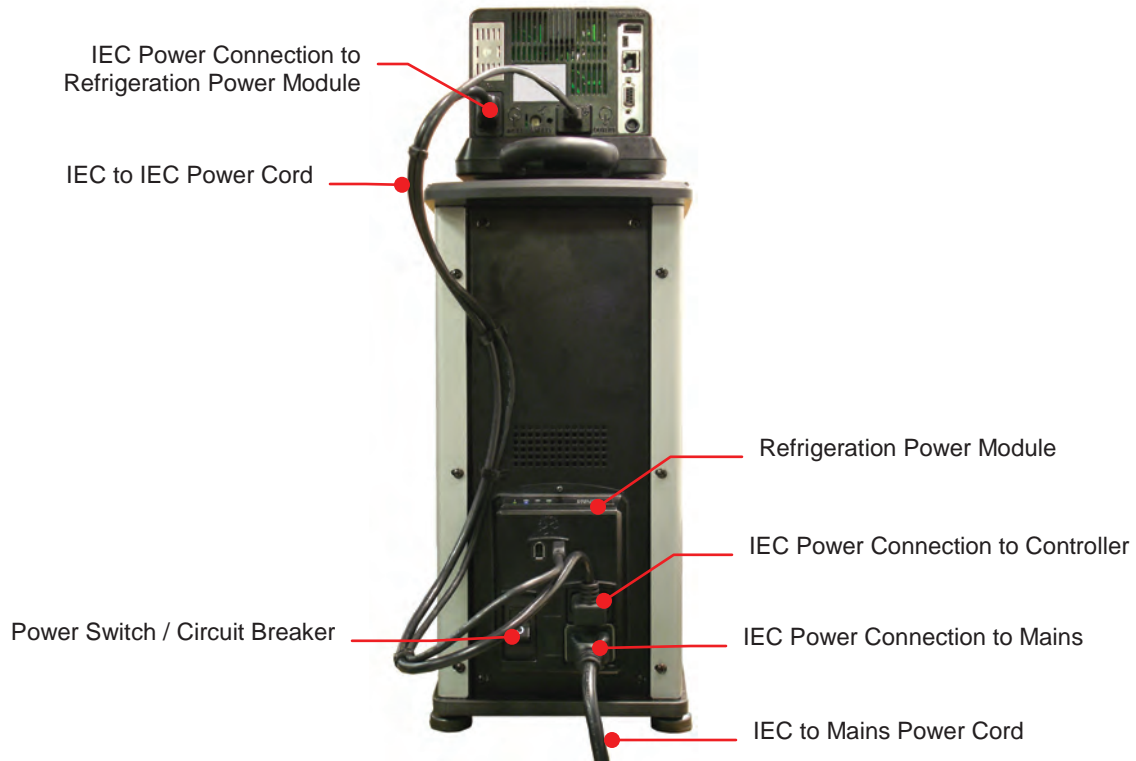

### Heat Only Circulators and Open Bath Systems

Attach the 6-ft / 1.8 m power cord to the IEC electrical connection on the Temperature Controller and then plug the male connector into the Mains electrical outlet.

Place the Power Switch / Circuit Breaker on the Temperature Controller in the ON position. The LCD on the Controller will light and "Standby" will appear on the display; the PolyScience logo and the Power Key will also light.



**NOTE:** To conserve power when not in use, the LCD will go black about 5 seconds after "Standby" appears. The Power Key and PolyScience logo will remain lit to indicate that the Controller is energized and ready to use.

## Communication

The Advanced Digital Controller features a variety of connectivity options. Following are some typical ways you can use them to monitor and control the operation of your Circulator.

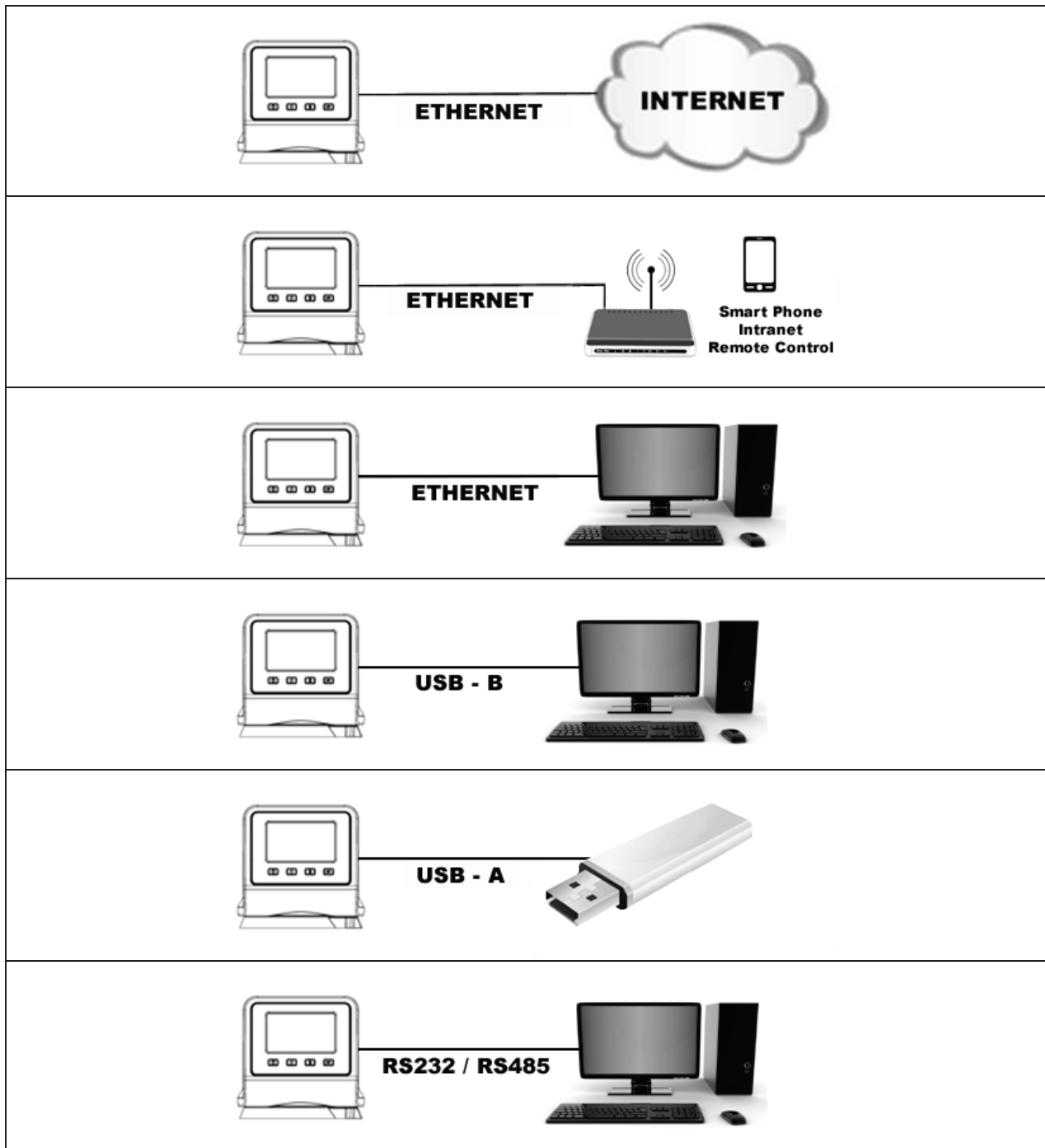

## USB Communication

Two USB ports (A and B) are provided on the rear of the Temperature Controller. USB A is intended for use with a flash drive and allows you to easily log temperature data. USB B allows you to remotely monitor and control your Circulator using a computer. See *Normal Operation, Selecting a Remote Communication and Control Protocol* and the *Technical Information* section of this manual for additional information.

## Ethernet

An Ethernet port is provided on the back of the Temperature Controller to enable you to connect your Circulator to a computer network. See *Normal Operation, Selecting a Remote Communication and Control Protocol* and the *Technical Information* section of this manual for additional information,

## RS232 / RS485 Serial Communication

	<b>CAUTION:</b> Always turn electrical power to the Circulator OFF before making a connection to the serial (DB9) port.
---	---

Your Circulator features RS232 / RS485 serial communication for remote data logging and control capability. A DB9 connector is provided on the rear of the Temperature Controller for this purpose. See *Normal Operation, Selecting a Remote Communication and Control Protocol* and the *Technical Information* section of this manual for additional information.

The serial interface should be connected to a serial communication port on a remote PC using an appropriate cable. Information on the RS232 / RS485 command and communication protocol can be found in the *Technical Information* section of this manual.

## External (P2) Temperature Probe

Your Circulator is capable of controlling temperature based on either the temperature of the internal bath or that of an external vessel or device. The connection for the optional external temperature probe is on the rear of the Temperature Controller. The Temperature Controller automatically detects the external temperature probe when it is connected. See *Replacement Parts & Accessories* for available lengths and part numbers.

### Pin Out Diagrams — External (P2) Temperature Probe Connection

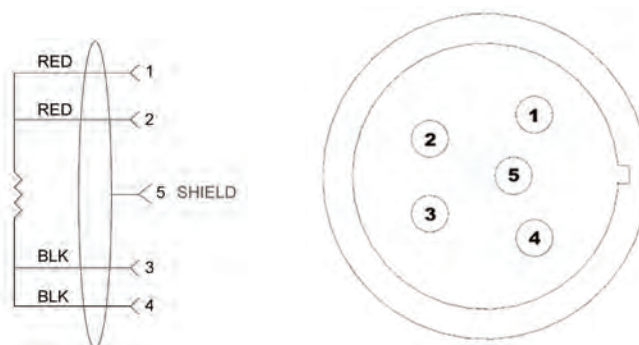

RTD SENSOR: 4 WIRE CIRCUIT, 100 OHMS @ 0 DEGREES C,  
MAXIMUM OPERATING TEMPERATURE @ 200 C, CLASS A 0.003850 OHMS/DEGREES C.

## Controller Setup

### Power

Press . The Circulator will begin running, actual and set point temperatures will be displayed, and the word "SET" will be continuously lit. The pump symbol will also be lit and the heating or refrigerating symbol may be lit or flashing.

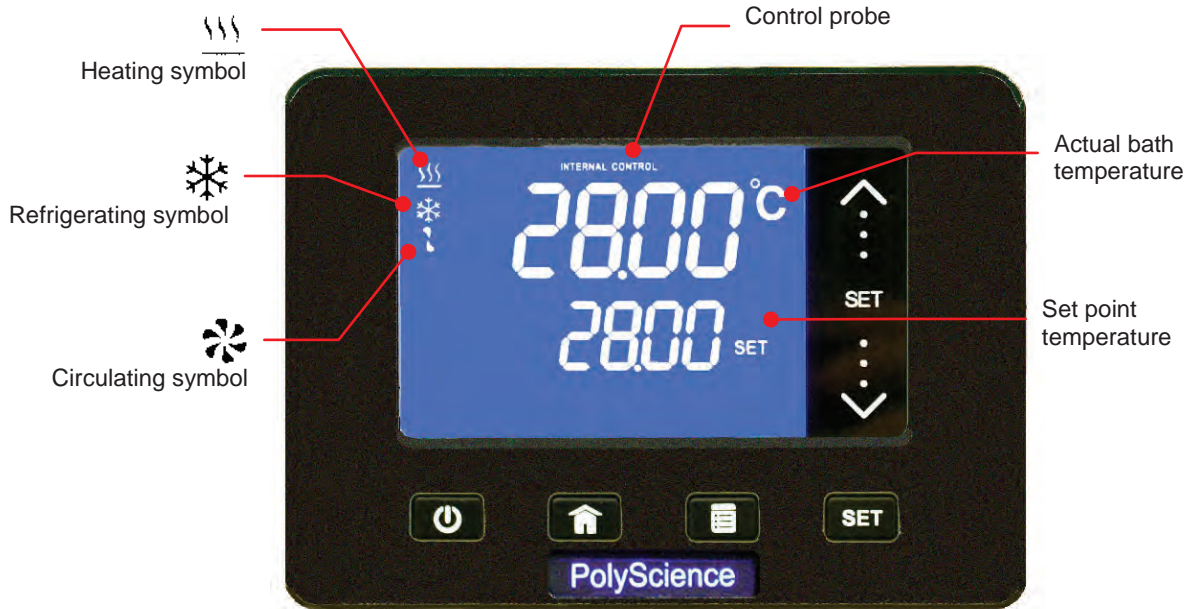

*Internal (P1) control only – external probe (P2) not connected*

## Safety Set Temperature

This is a “Do Not Exceed” temperature setting for your Circulator and is the temperature at which the heater will be turned OFF should the liquid level in the bath drop too low or the heater malfunctions. It is normally set about 5° higher than the desired operating temperature. Setting the Safety Set temperature is a simple 3-step procedure.

	<b>WARNING:</b> The Safety Thermostat is user-adjustable from approximately 100° to 220°C / 312° to 428°F. Do not force the indicator dial beyond the stops at either end of the dial's range.
---	--

1. Press the  key until SAFETY appears.





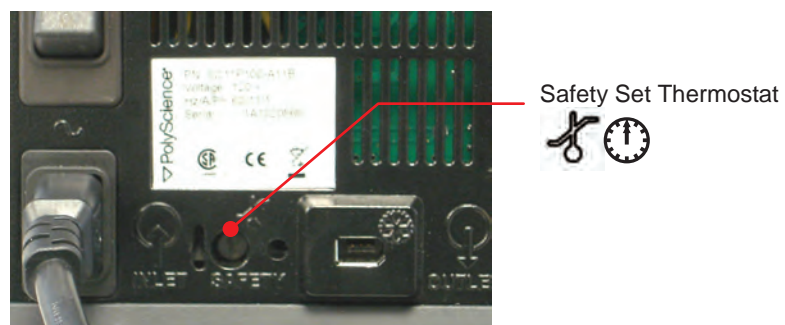

2. Using a No.1 Philips head screwdriver, rotate the Safety Thermostat on the rear of the Temperature Controller until the desired Safety Set Temperature is displayed (clockwise to increase; counter-clockwise to decrease).



3. Press  to return to the main operational screen.

## Normal Operation

### Keys and Controls

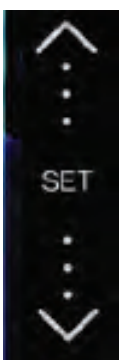
Power		Turns the Circulator's Temperature Controller ON.
Home		Returns the LCD to the Main Operational Display (from any screen).
Menu		Accesses the Temperature Controller's set-up sub-menus. The items in these sub-menus are used to configure the Controller's general operational parameters (temperature unit, pump speed, upper and low temperature limits, etc. (see Set-up Sub-Menus, below).
SET		Used in conjunction with the Touch Scroll Bar to change the set point temperature and some operational parameters.
Touch Scroll Bar		Used to make temperature set point and other operational changes. Slide finger up / down scroll bar or touch upper / lower sections to make minor adjustments; hold your finger on the scroll bar to make large adjustments.

### Turning Your Circulator ON

Press the  key.

When the Circulator begins running, the actual and set point temperatures will be displayed and the circulating symbol will be lit. If the optional external temperature probe is connected, a temperature value will also be displayed along the bottom of the screen. This is the bath temperature measured by the non-controlling (monitor) probe.

If the actual bath temperature is lower than the set point temperature, the heating symbol will also be lit.

Refrigerating/Heating Models: If the actual bath temperature is higher than the set point temperature, the refrigerating symbol will be lit. It is normal for both the heating and refrigerating symbols to be lit simultaneously when nearing or maintaining the set point temperature.



## Main Operational Display (Home)

This is the Circulators main operational display. You can return to this screen at any time by pressing the  key.

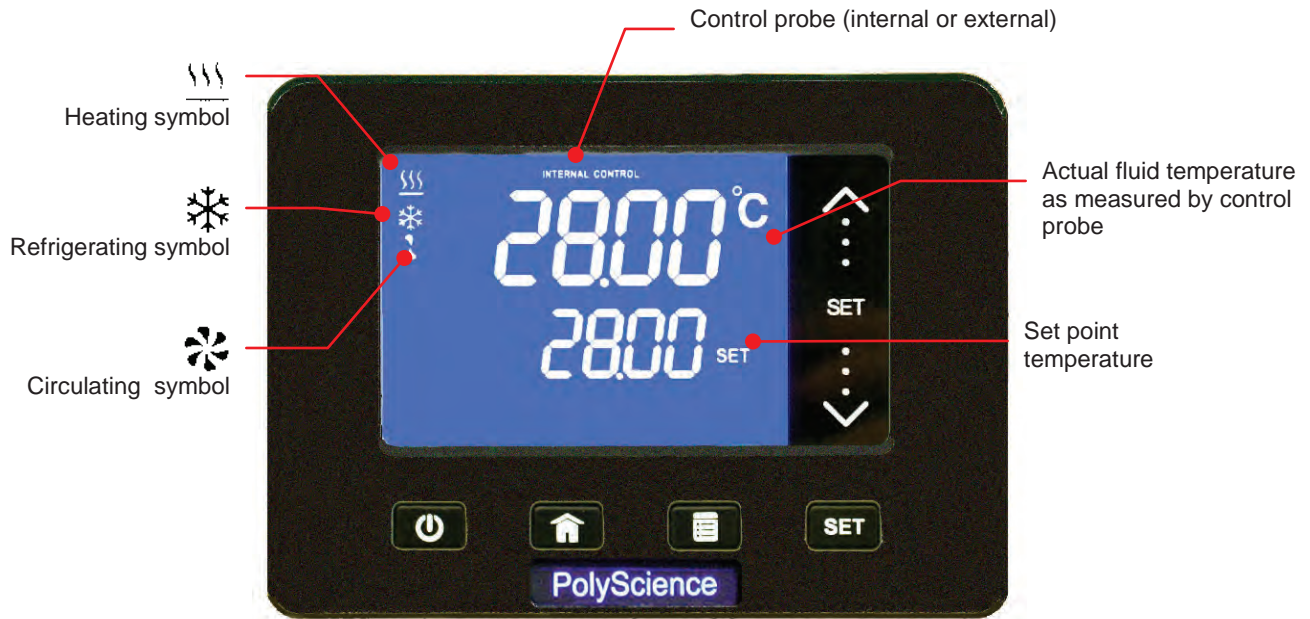

*Internal (P1) control only – external probe (P2) not connected*

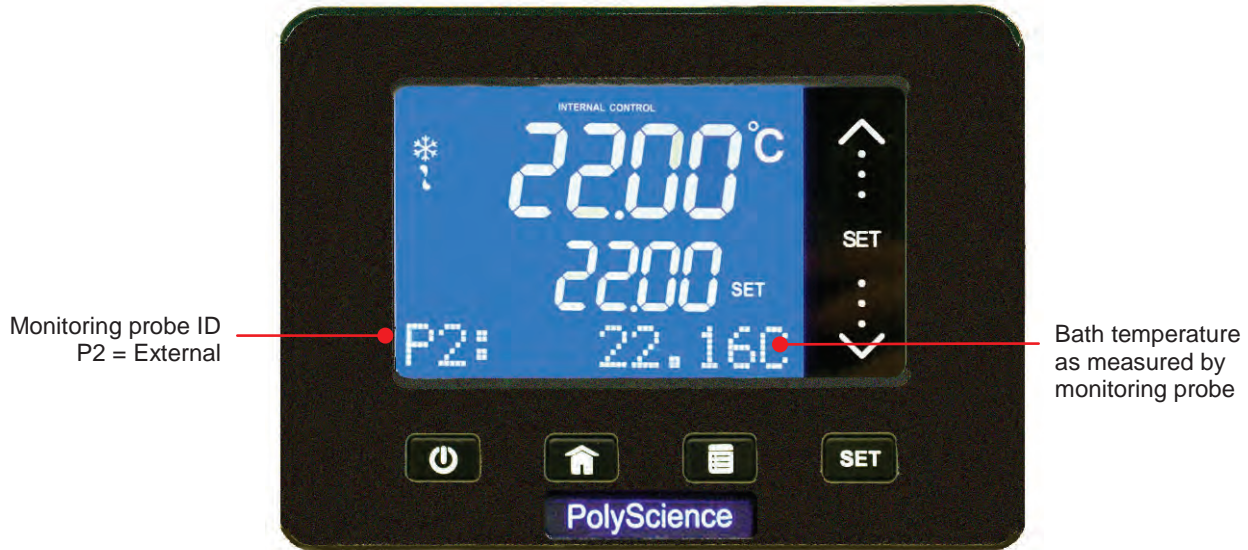

*Internal (P1) control – external probe (P2) connected*

Monitoring probe ID  
P1 = Internal

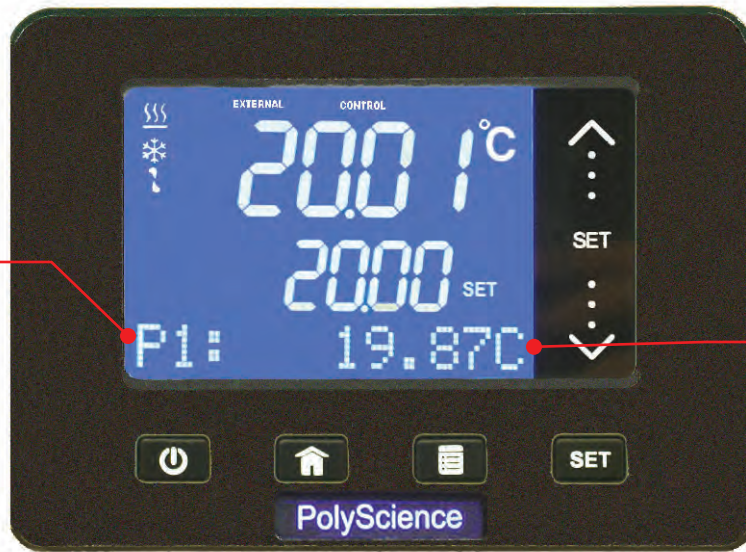



Bath temperature  
as measured by  
monitoring probe

*External (P2) control*

## Set-Up Sub-Menus

Pressing the  key accesses and scrolls through the Temperature Controller's set-up sub-menus. The Touch Scroll Bar is used to change the current setting / value in the sub-menus.

Sub-Menu	Description	Selection / Range	Factory Default
UNIT	Unit in which temperature is set and displayed	°C or °F	°C
PUMP	Pump speed	Variable – 5 to 100	40
HI LIM	High limit temperature	25° to 202°C / 80° to 395°F	202°C / 395°F
LO LIM	Low limit temperature	-52° to 20°C / -65° to 65°F	-52°C / -65°F
SET DIFF	Maximum allowable difference between the measured internal and external temperatures	2° to 20°C	10°C
AUTOCOOL	Temperature at which refrigeration is activated	1° to 150°C	45°C
SHC	The specific heat capacity of the bath fluid	0.10 to 2.00	1.00
CONTROL	Internal or external temperature control	P1 (Internal) or P2 (External)	P1
OFFSET / CALIBRATION	Calibration or display offset value Password required	-3.0°C to +3.0°C	0.0°C
SAFETY	Safety Set Temperature	~40° to 240°C	N/A
COM	Remote communication and control	RS232, RS485, USB, Ethernet	RS232
TIMER	Count down timer with audible signal	1 second to 999 minutes, 59 seconds	000:00
PASSWORD	Permits access to Calibration and Diagnostic screens	10 = Diagnostic screen 12 = Access Calibrate	0
USB LOG	Turns data logging ON and OFF	No (OFF) or Yes (ON)	No (OFF)
ENGLISH	Language in which information will be displayed	English, French, German, Spanish	English
pODO	Operational hours on pump	Display only	N/A
cODO	Operational hours on compressor	Display only	N/A
AUTO-ON	Determines how unit will restart after a disruption in electrical power	ON or OFF	OFF

To accept a value in a sub-menu, press , , , or allow the LCD to return to the main operational display ( approximately 10 seconds).

## Adjusting the Temperature Set Point

This is the temperature at which the fluid in your Circulating Bath will be maintained. It may be set to one-hundredth of a degree over a range of  $-50.00^{\circ}$  to  $+200.00^{\circ}\text{C}$  /  $-60.00^{\circ}$  to  $+390^{\circ}\text{F}$ . The factory default set point is  $+20.0^{\circ}\text{C}$  /  $+68.0^{\circ}\text{F}$ .

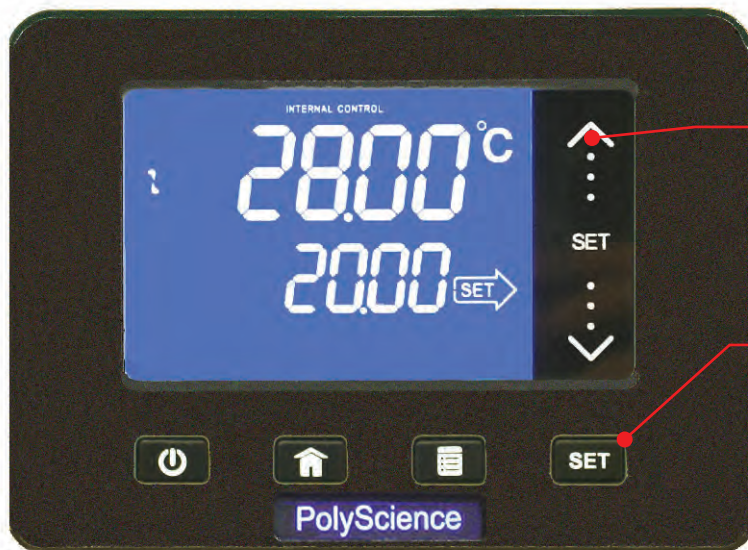

Touch and hold up/down arrows to make large changes

Touch and release arrows or slide finger up/down scroll bar to make small changes

Press SET once to change whole degree values

Press SET twice to make changes of less than a degree (decimal point will flash)

**To Change:** Press **SET**. The arrow around the word "SET" will begin flashing. To make changes of one degree or more, touch the scroll bar until the desired set point temperature is displayed. To make changes of less than a degree, (e.g.,  $0.50^{\circ}\text{C}$ ), press **SET** a second time. The decimal point will begin flashing. Touch the scroll bar until the desired value is displayed.

**To Accept:** Press **Menu**, **Home**, **SET**, or allow the LCD to return to the main operational display (approximately 10 seconds).



**NOTE:** An audible alarm and the words Low Limit or High Limit flashing on the display indicate that the temperature set point value is outside the Low Limit or High Limit value. The Circulator will continue to heat/cool until the actual bath temperature reaches the Limit value, at which point operation will stop.

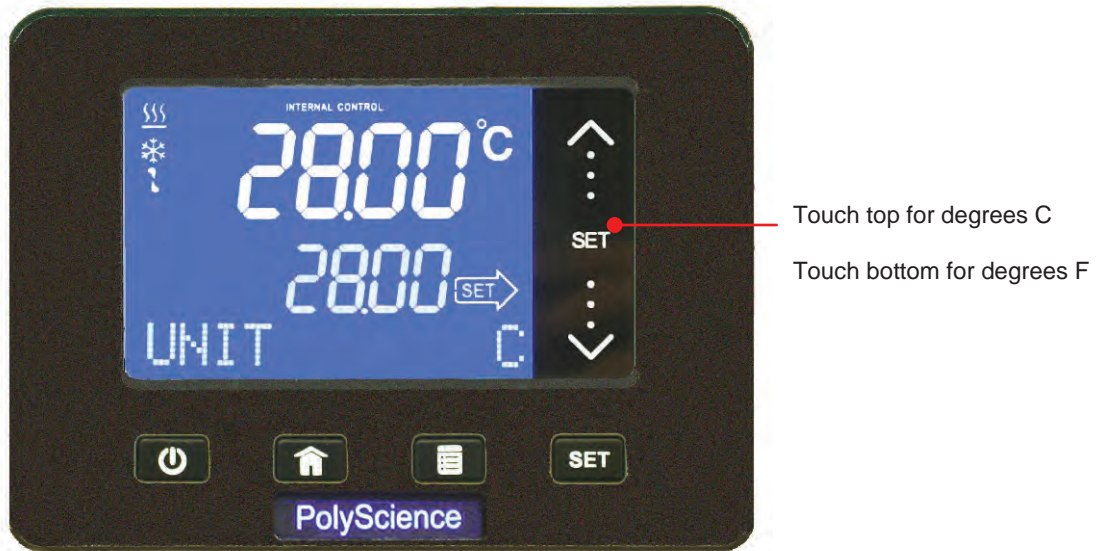

## Selecting the Temperature Unit

The temperature units sub-menu (°C / °F) allows you to select the temperature unit in which the actual bath temperature and set point temperature are displayed. The factory default is °C.



**To Access:** Press the  key until UNIT is displayed.

**To Change:** To select °F, touch the bottom portion of the scroll bar; to select °C, touch the top portion of the scroll bar.

**To Accept:** Press , , , or allow the LCD to return to the main operational display (approximately 10 seconds).

## Selecting the Pump Speed

This sub-menu allows you to set your Circulator's pump speed. The pump speed range is 5 to 100; the factory default is 40.

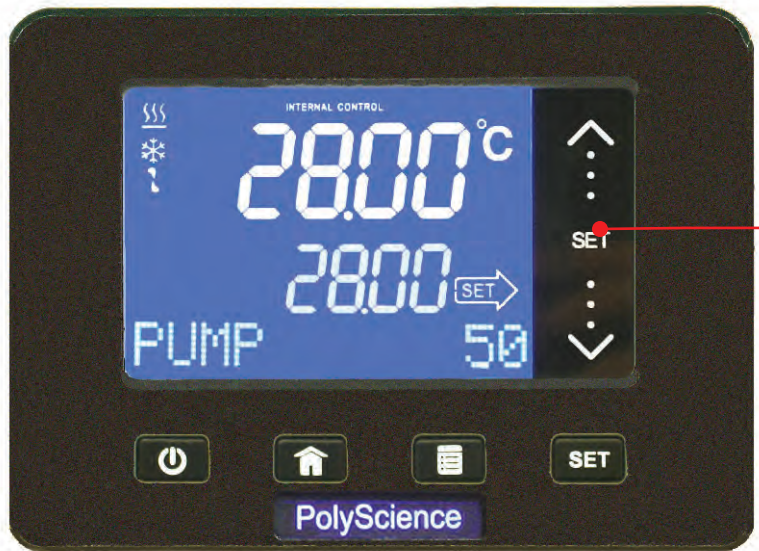



Touch and hold up/down arrows to make large changes

Touch and release to make minor changes

**To Access:** Press the  key until PUMP is displayed.

**To Change:** Touch the scroll bar until the desired pump speed is displayed (5 minimum, 100 maximum).

**To Accept:** Press , , , or allow the LCD to return to the main operational display (approximately 10 seconds).

## Setting the High Limit Temperature

This sub-menu allows you to limit how high the temperature set point may be set. It also serves as a high limit safety, alerting you if bath temperature rises above the high limit temperature setting. The High Limit value may be set from +25° to +202°C / +80° to +395°F; the factory default is 202°C.

To avoid an unwanted shutdown during regular operation, the High Limit value should be set at least 5° higher than the selected control temperature.





Touch and hold up/down arrows to make large changes

Touch and release to make minor changes

**To Access:** Press the  key until HI LIMIT is displayed.

**To Change:** Touch the scroll bar until the desired high limit temperature is displayed.

**To Accept:** Press , , , or allow the LCD to return to the main operational display (approximately 10 seconds).

## Setting the Low Limit Temperature

This sub-menu allows you to limit how low the temperature set point may be set. It also serves as a low limit safety, alerting you if bath temperature falls below the low limit temperature setting. The Low Limit value may be set from  $-52^{\circ}$  to  $+20^{\circ}\text{C}$  /  $-65^{\circ}$  to  $+65^{\circ}\text{F}$ ; the factory default is  $-52^{\circ}\text{C}$ .

To avoid an unwanted alarms or shutdown during regular operation, the Low Limit value should be set at least  $5^{\circ}$  lower than the selected control temperature.

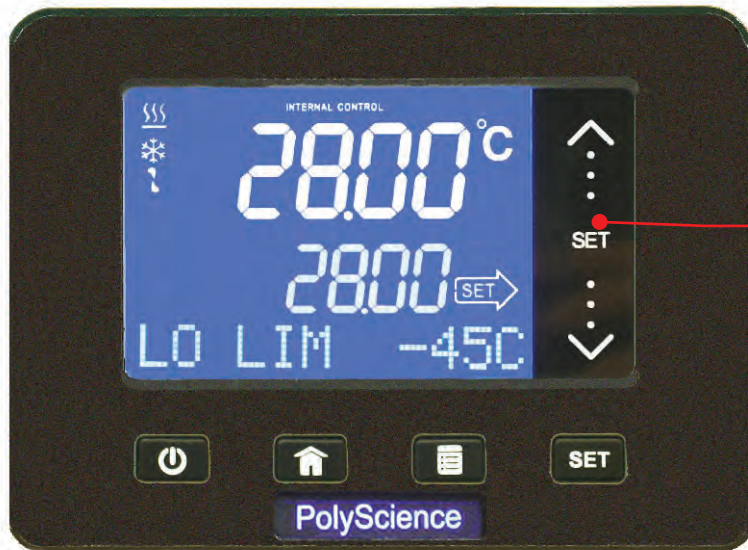



Touch and hold up/down arrows to make large changes

Touch and release to make minor changes

**To Access:** Press the  key until LO LIMIT is displayed.

**To Change:** Touch the scroll bar until the desired low limit temperature is displayed.

**To Accept:** Press , , , or allow the LCD to return to the main operational display (approximately 10 seconds).



## Setting the Differential Temperature

This sub-menu is for use when external temperature control (P2) is being used. It establishes the maximum allowable differential between the external and internal measured temperatures and is intended to prevent uncontrolled heating or cooling should the external temperature probe be dislodged or fail. The differential temperature may be set from 2° to 20°C; the factory default is 10°C.

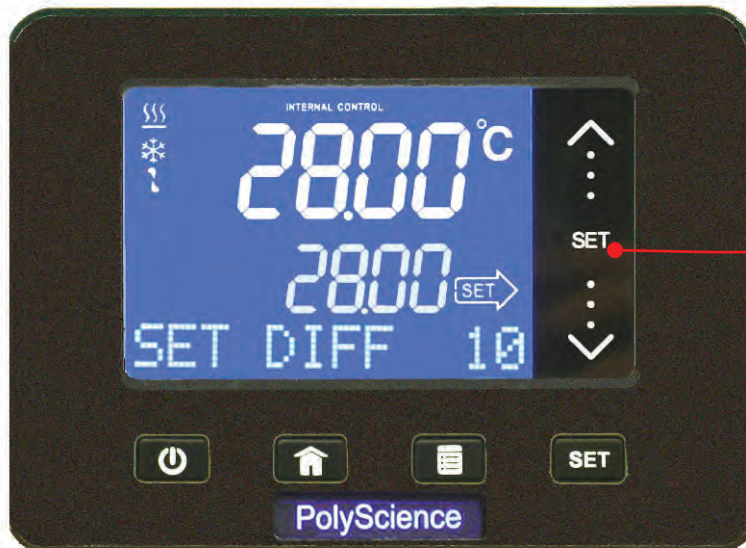



Touch and hold up/down arrows to make large changes

Touch and release to make minor changes

**To Access:** Press the  key until SET DIFF is displayed.

**To Change:** Touch the scroll bar until the desired P2 - P1 (external – internal ) temperature differential displayed.

**To Accept:** Press , , , or allow the LCD to return to the main operational display (approximately 10 seconds).



**CAUTION:** The Differential Temperature value is always shown in degrees C, even if degrees F is selected as the temperature unit in which the control and actual bath temperatures are displayed.

## Setting the Auto Cool Temperature

This sub-menu is displayed only on Refrigerating / Heating Circulators. It determines the set point temperature at which refrigeration will be activated and permits more precise control when operating at high temperatures as well as more rapid cool downs. For most applications, a set point that is 15°C above room temperature is recommended. The Auto Cool control range is from +1°C to 150°C. The refrigeration system will turn on when the bath temperature set point (150°C maximum) is below the Auto-Cool set point. The factory default is 45°C.

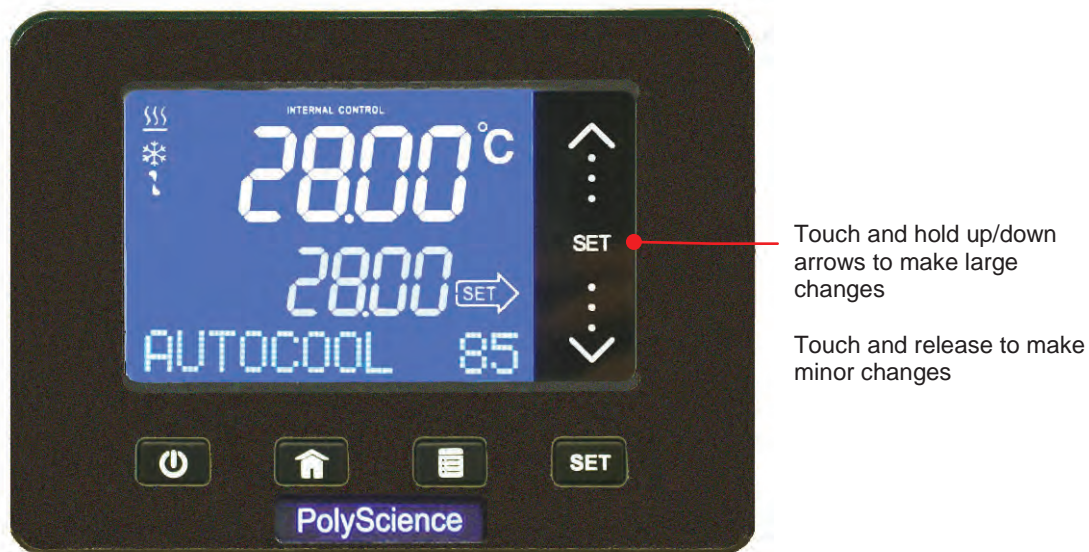

Cool Command™ Refrigeration — -40°C 7 liter Refrigerating/Heating Circulators and 15 liter and larger Refrigerating/Heating Circulators feature the Cool Command™ modulating refrigeration control system. Cool Command allows the refrigeration system to turn on at a fluid temperature up to 150°C when the temperature set point is changed to or below the Auto Cool set point (150°C maximum). As a result, bath fluid cools more quickly.

Conventional Refrigeration — -20°C 7 liter Refrigerating/Heating Circulators use a conventional refrigeration system. The refrigeration system will turn on when the bath fluid temperature and set point are below the Auto Cool set point (70°C maximum).



**To Access:** Press the  until AUTOCOOL is displayed.

**To Change:** Touch the touch scroll bar or touch the arrow symbols until the desired auto cool temperature is displayed.

**To Accept:** Press , , , or allow the LCD to return to the main operational display (approximately 10 seconds).

## Setting the Specific Heat Capacity (SHC)

This sub-menu allows you to tune the Circulator's control algorithm for the specific heat capacity (SHC) of the fluid you are using. The factory default is 1.00.

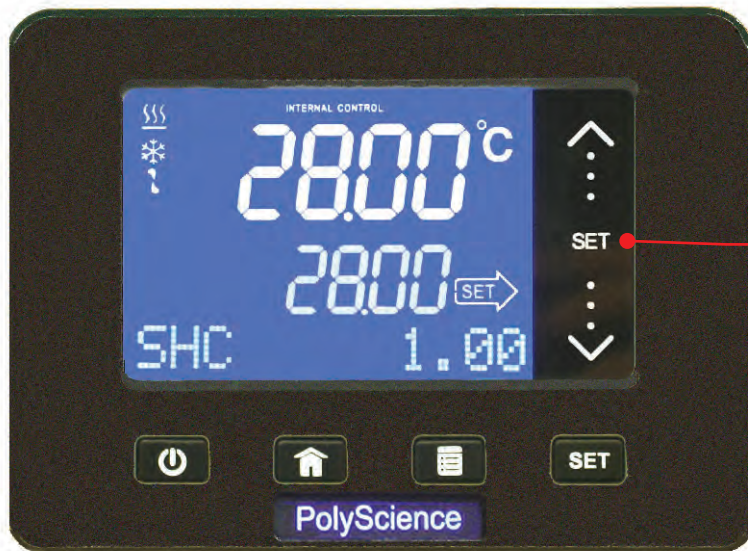



Touch and hold up/down arrows to make large changes

Touch and release to make minor changes

**To Access:** Press the  key until SHC is displayed.

**To Change:** Touch the touch scroll bar or touch the arrow symbols until the desired specific heat capacity value is displayed.

**To Accept:** Press , , , or allow the LCD to return to the main operational display (approximately 10 seconds).

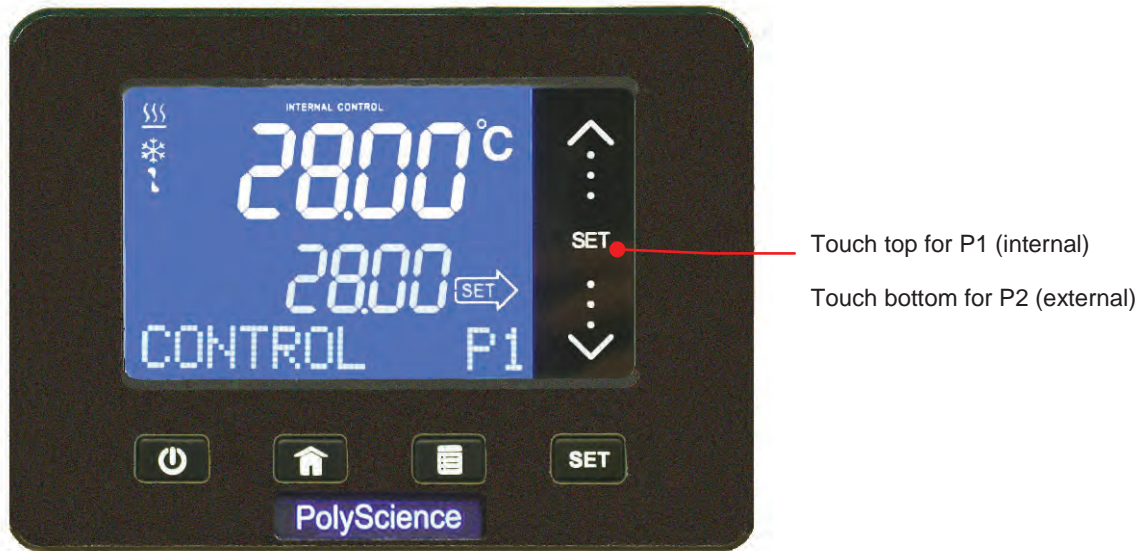

## Selecting Internal or External Temperature Control

This sub-menu lets you determine whether temperature control will be based on the fluid temperature within the Circulator's reservoir or the fluid temperature at an external device.



**To Access:** Press the  key until CONTROL is displayed.

**To Change:** Touch the scroll bar until the desired temperature probe is displayed. P1 = Internal; P2 = External.

**To Accept:** Press , , , or allow the LCD to return to the main operational display (approximately 10 seconds).



If P2 is selected but an external temperature probe is not connected to the Temperature Controller, P2 UNPLUGGED will appear on the display.

## Calibrating Your Circulator (Offset)

These two sub-menus allow you to match the Circulator's internal and/or external temperature probe to an external reference thermometer. A value from -3.0°C to +3.0°C may be entered; the factory default is 0.0°C.



**CAUTION:** The Offset Calibration value is always shown in degrees C, even if degrees F is selected as the temperature unit in which the control and actual bath temperatures are displayed. Your Circulator will automatically convert the °C offset calibration value to the correct °F display offset value.



**NOTE:** If you attempt to calibrate the Circulator when OFFSET is displayed, **Password!** will appear at the bottom of the screen. To proceed, advance to the PASSWORD sub-menu, enter 12, and then return to this sub-menu.



*Protected – Password Required*

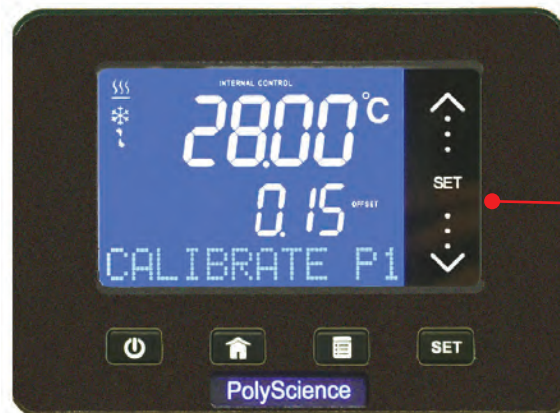



Touch top arrow to increase offset

Touch bottom arrow to decrease offset

*Unlocked*

**To Access:** Press the  key until the calibration sub-menu for the temperature probe you wish to calibrate (P1 or P2) is displayed. If this function has been locked, OFFSET will appear and must be unlocked before changes can be made; if this function has been unlocked, CALIBRATE will appear.

**To Change:** Touch the scroll bar or touch the arrow symbols until the desired calibration temperature displayed.

**To Accept:** Press , , , or allow the LCD to return to the main operational display (approximately 10 seconds).

## Displaying the Safety Set Temperature

This display shows the current Safety Set Temperature.





**NOTE:** If you attempt to set the Safety Set temperature using the scroll bar, **Rear Adjust** will appear at the bottom of the screen. Use the Safety thermostat on the rear of the Temperature Controller to adjust the Safety Set temperature.



**To Access:** Press the  key until SAFETY is displayed.

**To Change:** This is a display only. The Safety Set Temperature is changed using the Safety thermostat on the rear of the temperature controller. The temperature value shown on the display will change as the thermostat is adjusted.

**To Exit:** Press , , , or allow the LCD to return to the main operational display (approximately 10 seconds).

## Selecting a Remote Communication and Control Protocol

This sub-menu allows you to select the protocol you want to use for remote communication and control. The choices are RS232, addressable RS485, USB, and Ethernet; the factory default is RS232.

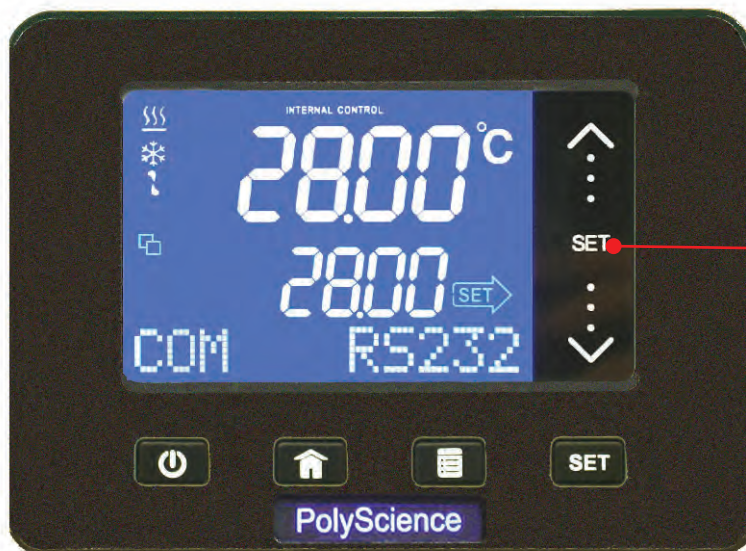



Touch top arrow for Ethernet

Touch areas between the arrows for USB and RS485

Touch bottom arrow RS232

**To Access:** Press the  key until COM and the currently selected protocol appears on the display.

**To Change:** To select RS232, touch the down arrow; to select Ethernet, touch the top arrow. RS485 and USB protocols are selected by touching areas on the scroll bar that lie between the two arrows.

**To Accept:** Press , , , or allow the LCD to return to the main operational display (approximately 10 seconds).



**CAUTION:** Although you can accept the displayed protocol by pressing either the Home, Menu, or SET keys, we recommend using the Menu key the first time a protocol is selected as there are additional parameters that must be configured when RS232, RS485, or Ethernet is selected. This will ensure that you are prompted to configure those parameters. See *Technical Information, RS232/RS485 Configuration* and *Technical Information, Ethernet Configuration* for additional information.



**NOTE:** See *Technical Information, USB Setup, Monitoring, and Control* for information on controlling your Circulator via the USB-B port.

## Using the Timer

This sub-menu allows you to set and activate the Temperature Controller's count-down timer. Any time duration from 1 second to 999 minutes, 59 seconds can be entered.

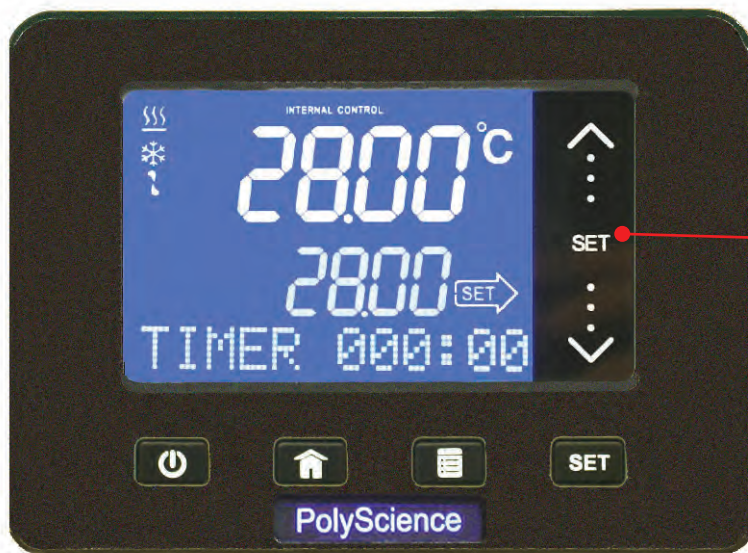

Touch and hold up/down arrows to set long durations

Touch and release set short durations changes

**To Access:** Press the  key until TIMER is displayed.

**To Change:** Touch the scroll bar until the desired time duration is displayed.

**To Start the Timer:** Press , The timer will begin counting down.

**To Pause the Timer:** Press . The display will revert to the main operational display.

To restart the timer, return to the Timer sub-menu and press .

The timer counts down in one second increments until it reaches 000:00. At this point, the time display flashes and an audible signal is activated. Press  to acknowledge and deactivate.





**NOTE:** You can access other menu functions while the timer is running without affecting the count down.



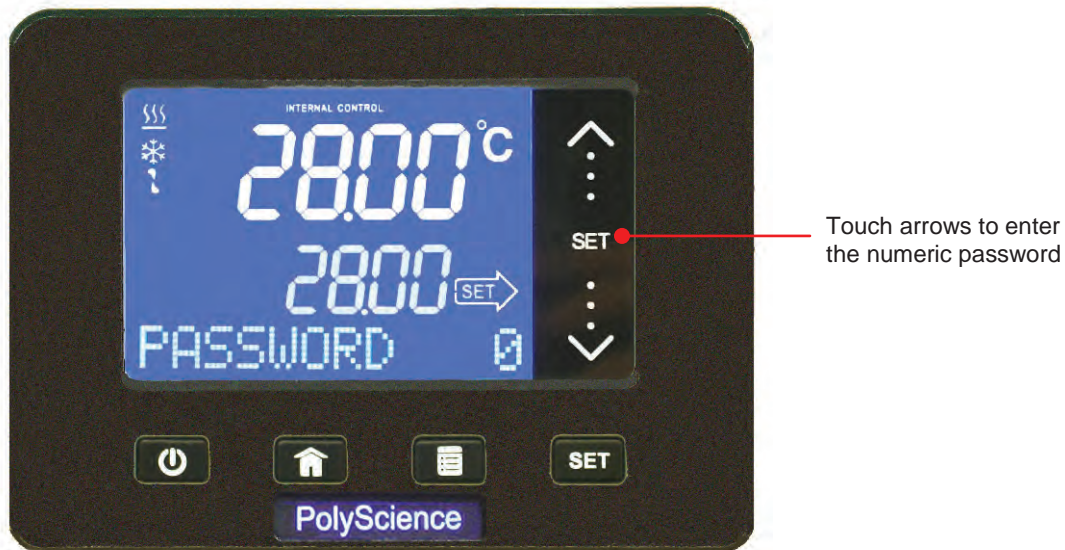

## Entering a Password

This sub-menu allows access to the Calibration and Diagnostic sub-menus.



**To Access:** Press the  key until PASSWORD is displayed.

**To Change:** Touch the scroll bar until the password needed to access the desired sub-menu is displayed. Calibration = 12; Diagnostic = 10)

**To Accept:** Press , , , or allow the LCD to return to the main operational display (approximately 10 seconds).



**IMPORTANT:** Once a password has been entered and accepted, the function it enables stays unlocked until either a new password is entered or the Circulator is turned OFF.

## Enabling / Disabling Data Logging

This sub-menu allows you to turn data logging ON and OFF.



**IMPORTANT:** This Advanced Digital Temperature Controller has both USB A and USB B ports. USB A is used for data logging; USB B is used for remote monitoring and control. Data is stored in a CSV file that can be read in spreadsheet programs such as Microsoft Excel<sup>®</sup>. To begin data logging, plug a flash drive into the USB A port and then set USB LOG to YES.





Touch top arrow to turn data logging ON (Yes)

Touch bottom arrow to turn data logging OFF (No)

**To Access:** Press the  key until USB LOG is displayed.

**To Change:** Touch the scroll bar until the desired status is displayed.

**To Accept:** Press , , , or allow the LCD to return to the main operational display (approximately 10 seconds).



**NOTE:** See the *Technical Information* for complete information regarding data logging file formats and content.

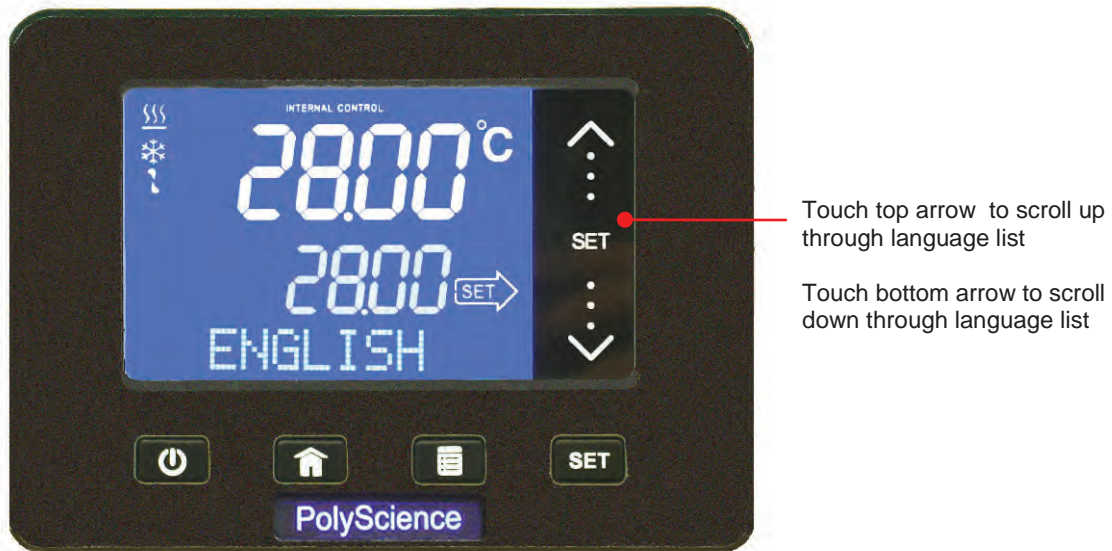

## Selecting the Operational Language

This sub-menu allows you select the language in which information will be displayed. The choices are English, Spanish, French, and German; the factory default is English.



**To Access:** Press the  key until the current language is displayed.

**To Change:** Touch the scroll bar until the desired language is displayed.

**To Accept:** Press , , , or allow the LCD to return to the main operational display (approximately 10 seconds).

## Setting Auto Restart



**WARNING:** The unit may start automatically after a disruption in electrical power.

This sub-menu allows you to select how the unit will begin operating after a disruption in electrical power. When Yes is selected, the Circulator will begin running automatically when power is restored. When No is selected, the Circulator will power up in the Standby mode.

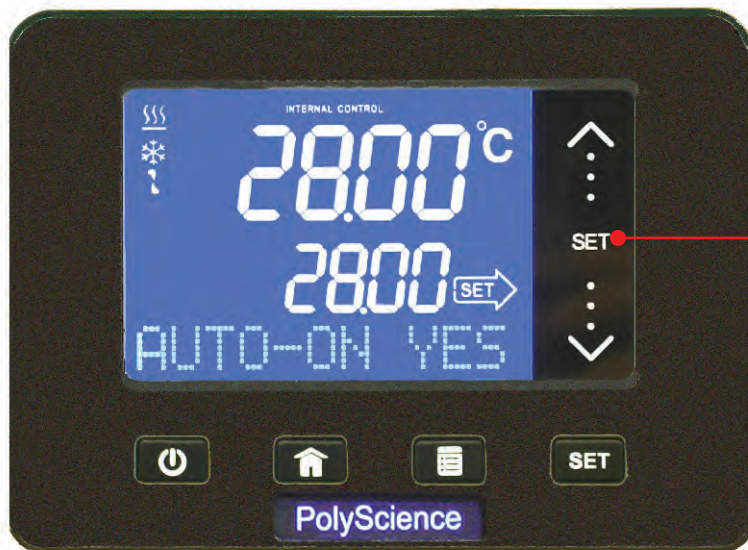



Touch top arrow to turn Auto-On ON (YES)

Touch bottom arrow to turn OFF (NO)



**To Access:** Press the  key until AUTO-ON is displayed.

**To Change:** Touch the top of the scroll bar to select Yes (ON); touch the bottom of the scroll bar to select No (OFF).

**To Accept:** Press , , , or allow the LCD to return to the main operational display (approximately 10 seconds).

## Resetting the Factory Default Values

To reset your Circulator to its original factory default values, proceed as follows:

1. Press the  key to place the unit in Standby.
2. Place the Power Switch / Circuit Breaker in the OFF position.
3. Return the Power Switch / Circuit Breaker to the ON position while pressing the  key until "STANDBY" appears on the display.
4. Press the  key.

## Changing Your Circulator's Viewing Angle

Your Circulator is equipped with Swivel 180™, an innovative feature which permits viewing of the temperature display from anywhere within a 180° radius.



**NOTE:** There are positive stops at 45° intervals; however, the viewing angle may be set anywhere within a 180° radius.

To change the viewing angle, slide the release latch to the right and rotate the Temperature Controller to the desired angle. The latch release will automatically return to the locked position at every 45° positive stop.

Swivel 180™ latch release

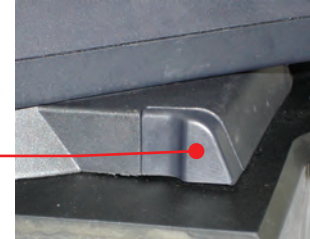

## Inert Gas Purge

A 0.125 in. / 3 mm port on the rear of the Temperature Controller is provided to allow you to blanket the surface of the liquid in the bath reservoir with nitrogen or another inert gas to help prevent condensation and dilution of the bath fluid.

## Tap Water Cooling

Tap water cooling allows for more rapid bath cool down from high temperatures and/or more precise operation at temperatures near ambient.

Heat only Circulating Baths feature an integrated cooling coil as standard equipment. The tap water connections are made on the rear of the unit. Two 0.25 inch / 6.4 mm female NPT fittings are provided for these connections.

Polycarbonate Viscosity Baths feature a cooling coil with two 0.375 inch / 9.5 mm OD straight barb fittings at which the fluid inlet and outlet connections can be made. Either connection may serve as the fluid inlet or outlet. Be sure to secure the tubing with the appropriate size hose clamps.

An optional cooling coil is available for use on Stainless Steel Open Bath systems. This cooling coil has two 0.375 inch / 9.5 mm OD straight barb fittings at which the fluid inlet and outlet connections can be made. Either connection may serve as the fluid inlet or outlet. Be sure to secure the tubing with the appropriate size hose clamps.









**WARNING:** The fluid outlet must be connected and flow to a suitable drain or vessel located at a level below that of the inlet.

## Reservoir Cover Storage



Refrigerating/Heating and Heat Only Circulating Baths feature the LidDock<sup>®</sup> system to eliminate mess when adding fluid or samples to the reservoir. Specially positioned notches in the inner lip of the top deck allow you to stand the reservoir cover up upright over the bath opening, allowing condensate to flow back into the bath.





## Display Messages and Alarms

Message and/or Symbol	Description	Corrective Action
<b>POWER FAILED</b>	<b>Informational:</b> Indicates that electrical power was lost during operation; appears only when Auto-On is set to Yes.	Press  key to clear the message.
<b>WARNING! LOW LIMIT!</b>	<b>Warning:</b> The fluid temperature or temperature set point is below the Low Limit value. (Message flashes, audible beep)	Decrease the Low Limit temperature value or increase the temperature set point. If problem is not corrected within about 30 seconds, the Circulator will go into a Low Limit Fault condition and operation will cease.
<b>WARNING! HIGH LIMIT!</b>	<b>Warning:</b> The fluid temperature or temperature set point is above the High Limit value. (Message flashes, audible beep)	Increase the High Limit temperature value or decrease the set point temperature. If problem is not corrected within about 30 seconds, the Circulator will go into a High Limit Fault condition and operation will cease.
<b>FAULT! LOW LIMIT!</b>	<b>Fault:</b> The bath temperature has fallen below the Low Limit temperature value. Power to the compressor and pump will remain OFF until the problem is corrected. (Message flashes, continuous tone)	Press  to turn power OFF. Restore power and then decrease the Low Limit temperature value or increase the temperature set point. Controller failure; consult factory.
<b>FAULT! HIGH LIMIT!</b>	<b>Fault:</b> The bath temperature risen has above the High Limit temperature value. Power to the heater and pump will remain OFF until the problem is corrected. (Message flashes, continuous tone)	Press  to turn power OFF. Restore power and then increase the High Limit temperature value or decrease the temperature set point. Controller failure; consult factory.
  <b>OVERTEMP</b> OR  <b>LOW FLUID</b>	<b>Fault:</b> The liquid in the bath has dropped too low or the temperature of the bath fluid has exceeded the Safety Set temperature. Power to the heater will remain OFF until the problem is corrected.	Fluid level in reservoir has fallen below minimum level; add fluid as required. Fluid temperature is higher than Safety Set temperature; increase Safety Set temperature setting. Controller failure; consult factory.
<b>FAULT! EXT PROBE 2</b>	<b>Fault:</b> The external temperature probe has been disconnected. Appears only when using External Control. (Message flashes, continuous tone)	Reconnect external probe, turn power OFF and then back ON. If problem persists, replace external probe or operate using Internal Control.

**Informational Messages** — Do not disrupt normal operation. Clear by pressing the  key.

**Warnings** — Circulator operation continues unless left uncorrected for approximately 35 seconds. Press the  key to silence the audible signal. Correct problem and press the  key a second time to clear Warning.

**Faults** — Circulator operation is halted (heater, pump, and compressor turn OFF). Press the  key to silence the audible signal. Press  to turn power OFF and then restore power and correct the problem.

## Routine Maintenance and Troubleshooting



**WARNING:** Always turn your Circulator OFF and disconnect it from the electrical power outlet before performing any maintenance or service.



**WARNING:** To avoid the potential for burns, allow the Circulator to cool completely before cleaning or performing any maintenance.

### Maintaining Clear Bath Water

Optimum temperature and moisture conditions for algae growth exist when using water as a bath fluid. To prevent algae contamination and minimize the frequency of draining the reservoir, an algaecide such as Polyclean Bath Algaecide (004-300040) should be used.



**WARNING:** Do not use chlorine bleach.

### Draining the Bath Reservoir



**WARNING:** Bath fluids should be stored and disposed of according to applicable laws and regulations.

### Refrigerated / Heating and Heat only Circulating Baths

Refrigerated / Heating and Heat only Circulating Baths are equipped with a drain valve and port located either beneath the front access panel or on the right hand side of the unit.

To drain fluid from the bath, attach a short length of suitable 0.45 inch / 11.5 mm ID tubing to the drain port and secure it using a hose clamp with a minimum ID of 0.7 inch / 18 mm. Open the drain valve using a flat blade screwdriver. When closing the valve, do not over tighten.



**WARNING:** Be sure to close the drain valve before refilling the bath reservoir. Do not over tighten.

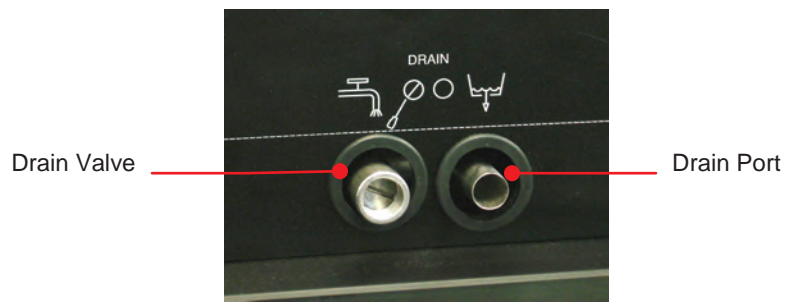



## Polycarbonate Viscosity Baths

Polycarbonate Viscosity Baths are equipped with a drain port. To drain fluid from these baths, remove the knurled cap.



**WARNING:** Be sure to replace and tighten knurled cap before refilling the bath reservoir. Do not over tighten.

## Checking the Over-Temperature / Low Liquid Level Safety Systems

Your Circulator incorporates over-temperature and low liquid level protection according to IEC 61010-2-010. For optimum safety, these systems should be checked at least every six months for proper operation. These checks must be performed with the unit running.

### Over-Temperature Protection

1. Press  until the Safety sub-menu is displayed.



Safety Set Temperature

2. Using a No.1 Philips head screwdriver, rotate the Safety Set Thermostat on the rear of the Temperature Controller until the unit shuts down. The Safety Set temperature at this point should be the same as the actual bath temperature.
3. Return the Safety Set temperature to the desired over-temperature value.
4. Press the  key to return to the Main Operational Display.



### Low Liquid-Level Protection

1. Set the temperature set point to ambient and allow the Circulator to stabilize at that temperature.
2. Increase the temperature set point to about 5°C above ambient and slowly drain fluid from the bath.
3. Continue draining fluid until the unit shuts down. The fluid level at this point should be approximately 3.75 in. / 9.5 cm below the underside of the Circulator's top deck.
4. Replace the bath fluid and return to normal operation.

## Cleaning Your Circulator



**WARNING:** It is the user's responsibility to properly decontaminate the unit in the event hazardous materials are spilled on exterior or interior surfaces. Consult the manufacturer if there is any doubt regarding the compatibility of decontamination or cleaning agents.

### Temperature Controller

Turn the Temperature Controller OFF by pressing  and unplug power cord from the electrical outlet.

Wipe the housing with a clean cloth dampened with a mild detergent and water or mild all-purpose cleaner.



**CAUTION:** Do not spray cleaning liquids directly onto the Temperature Controller or allow them to enter the Controller's vents. Do not use abrasives as these could scratch the housing or the digital display.

### Bath Reservoir

Bath Reservoir and Wetted Components — A concentrated bath cleaner (polyclean Bath Cleaner, part number 004-300050) is available to remove mineral deposits from the stainless steel reservoir and the Temperature Controller's wetted parts. The cleaner should be added to the bath reservoir at the prescribed dosage and circulated at 60°C / 140°F until the scale is removed.



**CAUTION:** Do not use steel wool to clean your Circulator's bath reservoir.

External Surfaces — Only mild detergents and water or an approved cleaner should be used on the top deck and other external surfaces of your Circulator. Do not allow cleaning liquids or sprays to enter the vents on the rear of the Temperature Controller.

### Pump Impeller

In the unlikely event that debris becomes lodged in the pump impeller, a soft brush can be used to remove any lodged particles. If necessary, soak in a solution of distilled water and polyclean Bath Cleaner to soften before brushing.



**CAUTION:** Do not use hard utensils or abrasive pads to remove trapped debris.

### Condenser, Air Vents, and Reusable Filter (Refrigerating / Heating Circulators only)

To keep the refrigeration system operating at optimum cooling capacity, the condenser, removable air filter, and all air vents (front, side, back) should be kept free of dust and dirt. Be sure to check them on a regular basis and clean as required.

The reusable filter is easily accessed from the front of the unit by simply removing the access panel. Use a mild detergent and water solution to wash off any accumulated dust and dirt. Rinse and dry thoroughly before reinstalling.



## Temperature Controller Removal and Re-Installation

### Removal

The Temperature Controller on your Circulating Bath is designed to be easily removed from the top deck without the use of special tools. It is removed as follows:

1. Place the tip of a small flat blade screwdriver under the retaining ring locking tab and pry up gently.

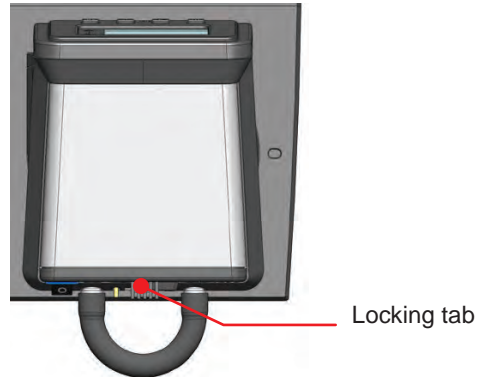

2. Rotate the Temperature Controller clockwise until it stops (about 0.75 inch / 1.9 cm).



3. Lift the Controller straight up and out of the opening of the Circulator's top deck.

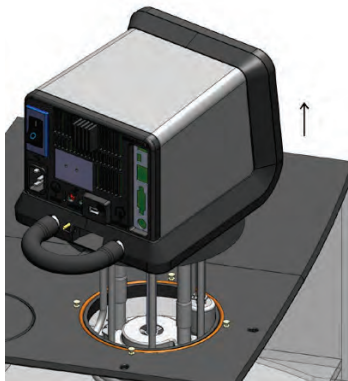

## Re-Installation

The top deck of your Circulator incorporates four pins to facilitate positioning of the Temperature Controller when it is being reinstalled. These pins correspond to keyhole slots on the interior of the Circulator's retaining ring.

1. With the retaining ring locking tab oriented above one of the indents on the top deck, slowly lower the Temperature Controller into the top deck opening until it is resting on top of the positioning pins.

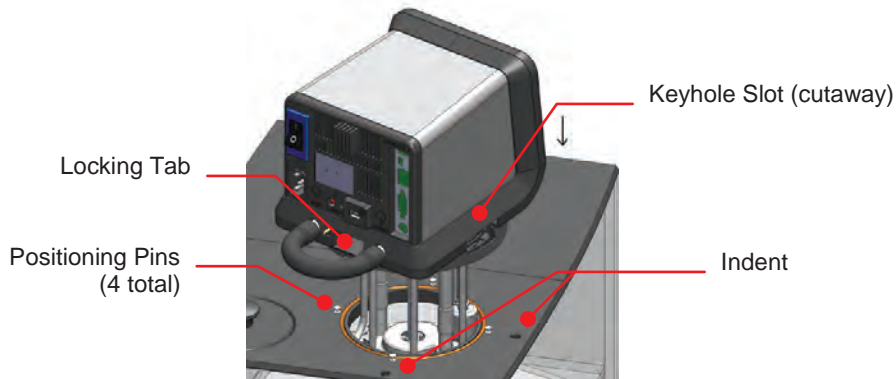

2. Gently rotate the Temperature Controller until it drops down on the positioning pins.



3. Rotate the Temperature Controller counter-clockwise until the Locking Tab engages the indent on the top deck.



## Viewing Component Operating Time

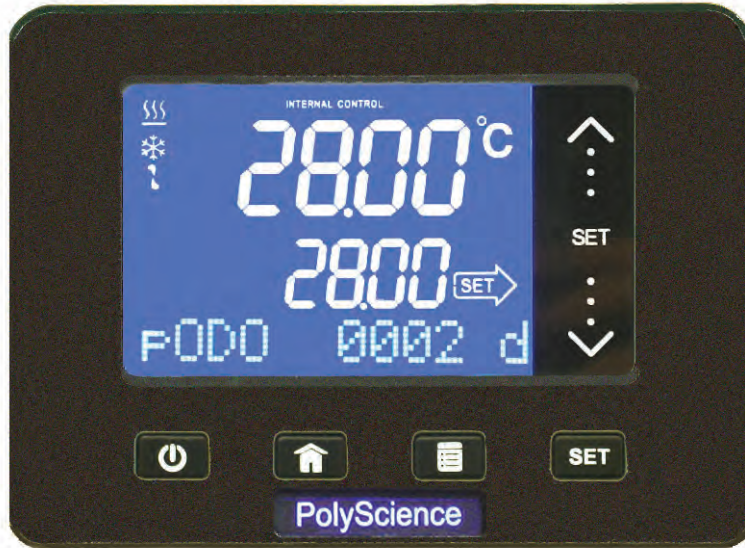

Your Circulator tracks pump and (on Refrigerating/Heating Circulators) compressor operation, This run time is initially tracked in hours and minutes and then in days. You can view this information by pressing the  key until the pODO or cODO screen appears:

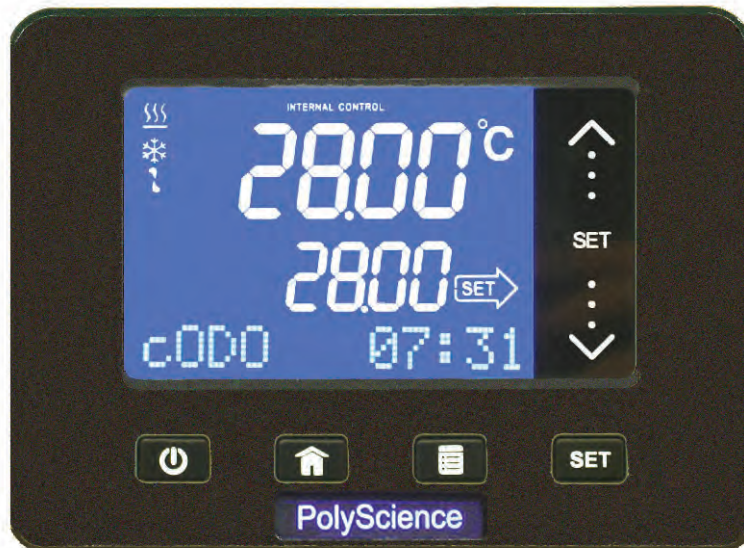

*Pump Operating Time – (shown here in days)*



*Compressor Operating Time – (shown here in hours and minutes)*

**To Exit:** Press , , , or allow the LCD to return to the main operational display (approximately 10 seconds).

## Troubleshooting Chart

Problem	Possible Causes	Corrective Action
Unit does not run (Digital Display is blank)	No power to unit	Check that the electrical cord is secure and connected to an operating electrical outlet.
Unit does not run (STANDBY appears on Digital Display)	Unit in Standby mode	Press Power Key on front panel.
No fluid circulation	Insufficient fluid in reservoir Pump impeller jammed	Add fluid to reservoir. Inspect pump and remove debris as required.
Insufficient circulation	Fluid viscosity too high External tubing diameter too small Low line voltage	Replace with lower viscosity bath fluid. Replace with larger diameter tubing. Check and correct as required.
Unit does not heat	Insufficient fluid in reservoir Temperature set point too low Safety Set Temperature too low	Add fluid to reservoir. Increase temperature set point. Increase Safety Set temperature.
Insufficient heating	Insufficient circulation Low line voltage Ambient temperature too cool Excessive heat loss	See Insufficient circulation, above. Check and correct as required. Increase ambient temperature or relocate unit. Check for heat loss from external tanks and hoses; Check for vapor/heat loss from internal reservoir.
Temperature unstable	Insufficient circulation Debris or mineral build-up on pump, heater, or temperature sensor.	Check pump flow and operation. Clean as required.
Unit does not cool	Dust build up on air filter or condenser Blocked air ventilation screens Temperature set point is too high Excessive heat load Ambient air temperature too high (>35°C / 95°F) Low or high line voltage	Clean air filter and/or condenser as required. Remove blockages as required. Decrease temperature set point. Check that heat load does not exceed capacity of bath; correct as required. Decrease ambient air temperature. Check and correct as required.

<b>Problem</b>	<b>Possible Causes</b>	<b>Corrective Action</b>
Insufficient cooling	Dust build up on air filter or condenser Blocked air ventilation screens Temperature set point is too high Excessive heat load Ambient air temperature too high (>35°C / 95°F) Low or high line voltage	Clean air filter and/or condenser as required. Remove blockages as required. Decrease temperature set point. Check that heat load does not exceed capacity of bath; correct as required. Decrease ambient air temperature. Check and correct as required.
Unable to achieve low end extreme temperatures	Pump speed too high Incorrect bath fluid Insufficient insulation on external fluid lines Ambient air temperature too high (>35°C / 95°F) Low or high line voltage Dust build up on air filter or condenser Blocked air ventilation screens Excessive heat load	Reduce pump speed. Check that the fluid being circulated is capable of reaching the required temperature. Check external fluid lines for proper insulation. Decrease ambient air temperature as required. Check and correct as required. Clean air filter or condenser as required. Remove blockages as required. Check that heat load does not exceed capacity of bath; correct as required.



# Technical Information

## Performance Specifications

Operating Temperature Range:	Model dependent; see table below	
Temperature Stability:	±0.01C (±0.02°F)	
Pump Type:	Variable speed pressure/suction	
	<u>60Hz models</u>	<u>50Hz models</u>
Maximum Pressure:	4.3 psi (0.30 bar)	3.6 psi (0.25 bar)
Maximum Pressure Flow Rate:	5.3 gpm (20.1 lpm)	4.4 gpm (16.7 lpm)
Maximum Suction Flow Rate:	3.9 gpm (14.7 lpm)	3.2 gpm (12.2 lpm)
Heater Wattage:	1100 watts	2200 watts

Model Type	Reservoir Capacity	Temperature Range	Electrical Requirements	
			60Hz Units	50Hz Units
AD7LR-20 Refrigerating / Heating Bath	7 liters	-20° to 200°C -4° to 392°F	120V, 60Hz, 12A	240V, 50Hz, 12A
AD07R-20 Refrigerating / Heating Bath	7 liters	-20° to 200°C -4° to 392°F	120V, 60Hz, 12A	240V, 50Hz, 12A
AD07R-40 Refrigerating / Heating Bath	7 liters	-40° to 200°C -40° to 392°F	120V, 60Hz, 12A	240V, 50Hz, 12A
AD15R-30 Refrigerating / Heating Bath	15 liters	-30° to 200°C -22° to 392°F	120V, 60Hz, 13A	240V, 50Hz, 13A
AD15R-40 Refrigerating / Heating Bath	15 liters	-40° to 200°C -40° to 392°F	120V, 60Hz, 13A	240V, 50Hz, 13A
AD20R-30 Refrigerating / Heating Bath	20 liters	-30° to 200°C -22° to 392°F	120V, 60Hz, 13A	240V, 50Hz, 13A
AD28R-30 Refrigerating / Heating Bath	28 liters	-30° to 200°C -22° to 392°F	120V, 60Hz, 13A	240V, 50Hz, 13A
AD45R-20 Refrigerating / Heating Bath	45 liters	-25° to 135°C -13° to 275°F	208-240V, 50/60Hz, 12A	208-240V, 50/60Hz, 12A
AD07H200 Heating Only Bath	7 liters	Ambient +10° to 200°C Ambient +20° to 392°F	120V, 60Hz, 10A	240V, 50Hz, 10A
AD15H200 Heating Only Bath	15 liters	Ambient +10° to 200°C Ambient +20° to 392°F	120V, 60Hz, 10A	240V, 50Hz, 10A
AD20H200 Heating Only Bath	20 liters	Ambient +10° to 200°C Ambient +20° to 392°F	120V, 60Hz, 10A	240V, 50Hz, 10A
AD28H200 Heating Only Bath	28 liters	Ambient +10° to 200°C Ambient +20° to 392°F	120V, 60Hz, 10A	240V, 50Hz, 10A
AD06S150 Open Bath System	6 liters	Ambient +10° to 150°C Ambient +20° to 302°F <sup>(1)</sup>	120V, 60Hz, 10A	240V, 50Hz, 10A
AD10S150 Open Bath System	10 liters	Ambient +10° to 150°C Ambient +20° to 302°F <sup>(1)</sup>	120V, 60Hz, 10A	240V, 50Hz, 10A
AD20S150 Open Bath System	20 liters	Ambient +10° to 150°C Ambient +20° to 302°F <sup>(1)</sup>	120V, 60Hz, 10A	240V, 50Hz, 10A
AD28S150 Open Bath System	28 liters	Ambient +10° to 150°C Ambient +20° to 302°F <sup>(1)</sup>	120V, 60Hz, 10A	240V, 50Hz, 10A
AD29VB5R Viscosity Bath	29 liters	Ambient +10° to 85°C Ambient +20° to 185°F <sup>(2)</sup>	120V, 60Hz, 10A	240V, 50Hz, 10A
AD29VB3S Viscosity Bath	29 liters	Ambient +10° to 85°C Ambient +20° to 185°F <sup>(2)</sup>	120V, 60Hz, 10A	240V, 50Hz, 10A

1. Maximum operating temperature at which ±0.01°C temperature stability can be maintained; Advanced Digital Controller is capable of higher temperatures.





2. Maximum operating temperature for polycarbonate tank. Advanced Digital Controller capable of higher temperatures.

Environmental Conditions	Indoor use only	
Maximum Altitude:	2000 meter	
Operating Ambient:	5° to 35°C (41° to 95°F)	
Relative Humidity:	80%, non-condensing	
Installation Category:	II	
Pollution Degree:	2	
Ingress Protection:	IP 31	
Climate Class:	SN	
Software Class:	B	
Output Waveform:	Sinusoidal	

Specifications subject to change without notice.

## Reservoir Fluids

Depending on your needs, a variety of fluids can be used with your Circulator. No matter what bath fluid is selected, it must be chemically compatible with the reservoir and the materials in your Circulator. It must also be suitable for the desired temperature range.

	<p><b>WARNING:</b> When using Class III flammable fluids per DIN 12876-1, the user must attach the following warning labels to the front of the unit so that they are well visible:</p>		
	<p><b>Warning Label</b> W09 Colors: Yellow/black</p>		<p><b>Danger Area.</b> <b>Attention! Observe instructions (operating manual, safety data sheet)</b></p>
	<p><b>Mandatory Label</b> M018 Colors: Blue/white</p> <p>or</p> <p>Semi S1-0701 Table A1-2 #9 Colors: Blue/white</p>	  	<p><b>Carefully read the user information prior to beginning operation.</b> Scope: EU</p> <p><b>Carefully read the user information prior to beginning operation.</b> Scope: NAFTA</p>

	<p><b>WARNING:</b> Always use fluids that satisfy safety, health, and equipment compatibility requirements. Be aware of the chemical hazards that may be associated with the bath fluid used. Observe all safety warnings for the fluids used as well as those contained in the material safety data sheet.</p>
---	---

For optimum temperature stability, the fluid's viscosity should be 50 centistokes (cSt) or less at its lowest operating temperature. This permits good fluid circulation and minimizes heating from the pump.

For temperatures from 10°C to 90°C, distilled water is recommended. For temperatures below 10°C, a mixture of laboratory grade ethylene glycol and water should be used. Do not use deionized water.

The following chart is intended to serve as a guide in selecting a bath fluid for your application. For optimum temperature stability and low vaporization, be sure to stay within the fluid's normal temperature range.

**You are responsible for proper selection and use of the fluids. Avoid extreme range operation.**

Fluid Description	Viscosity (cSt) @ 25°C	Specific Heat			Normal Temperature Range	Extreme Temperature Range
		@ Fluid Temperature	BTU/lb°F	KJ/Kg°C		
distilled water	1	50°C	1.00	4.18	10° to 90°C	2° to 100°C
polyclear MIX 30	1	50°C	1.00	4.18	15° to 90°C	2° to 100°C
polytherm S150	50	100°C	0.41	1.71	50° to 150°C	5° to 270°C*
polytherm S200	125	150°C	0.40	1.67	100° to 200°C	80° to 232°C*
polytherm S250	500	200°C	0.39	1.63	150° to 250°C	125° to 260°C*
polytherm M170	40	85°C	0.40	1.67	50° to 170°C	25° to 190°C
polycool HC -50	3	-30°C	0.62	2.59	-50° to 100°C	-62° to 118°C
polycool EG -25 (50/50 mix with distilled H <sub>2</sub> O)	20	-20°C	0.78	3.26	-25° to 100°C	-30° to 115°C
polycool EG -25 (30/70 mix with distilled H <sub>2</sub> O)	12	0°C	0.89	3.72	0° to 95°C	-15° to 107°C
polycool PG -20 (50/50 mix with distilled H <sub>2</sub> O)	20	-10°C	0.83	3.47	-20° to 100°C	-30° to 115°C
polycool PG -20 (30/70 mix with distilled H <sub>2</sub> O)	12	5°C	0.92	3.85	5° to 90°C	-10° to 107°C
polycool MIX -25 (50/50 mix with distilled H <sub>2</sub> O)	20	-20°C	0.78	3.26	-25° to 100°C	-30° to 115°C
polycool MIX -25 (30/70 mix with distilled H <sub>2</sub> O)	12	0°C	0.89	3.72	0° to 95°C	-15° to 107°C



**\*WARNING:** This is the fluid's flash point temperature.



**WARNING: DO NOT USE THE FOLLOWING LIQUIDS:**

- Automotive antifreeze with additives\*\*
- Hard tap water\*\*
- Deionized water with a specific resistance > 1 meg ohm
- Concentrations of acids or bases
- Solutions with halides: chlorides, fluorides, bromides, iodides or sulfur
- Bleach (Sodium Hypochlorite)
- Solutions with chromates or chromium salts
- Glycerine
- Syltherm fluids

\*\* At temperatures above 40°C, additives or mineral deposits can adhere to the heater. If deposits are allowed to build up, the heater may overheat and fail. Higher temperatures and higher concentrations of additives will hasten deposit build up.

## Application Notes

At a fluid's low temperature extreme:

- The presence of ice or slush adversely affects temperature stability.
- A viscosity above 10 centistokes adversely affects temperature uniformity.
- A high fluid viscosity and high pump speed adds heat to the fluid being pumped.

At a fluid's temperature above ambient without refrigeration:

- If your set point temperature is less than 15°C above the ambient temperature, the viscosity of the fluid should be 10 centistokes or less to minimize friction heating of the fluid.
- Heat loss should be encouraged by uncovering the fluid and lowering the pump speed.

At a fluid's high temperature extreme:

- Heat loss from vapor adversely affects temperature stability.
- To prevent the accumulation of vapors inside the room, the reservoir may need to be placed under a fume hood.
- Use a cover and/or floating hollow balls to help prevent heat and vapor loss.
- Replenish fluid lost from vapor frequently.

## Tubing and Fitting Temperature Ranges

Material	Temperature Range
Buna N tubing	-40° to 120°C
Viton® tubing	-32° to 200°C
Braided Teflon® lined tubing	-50° to 225°C
Stainless steel fittings	-45° to 225°C
Nylon fittings	-40° to 90°C
Brass fittings	-40° to 80°C

## Fluid Compatibility

	Buna N Tubing	Viton Tubing	Braided Teflon Tubing	Stainless Steel Fittings	Nylon Fittings	Brass Fittings
polycool EG -25	A	A	A	B	A	B
polycool PG -20	A	A	A	B		B
polycool HC -50	B	B	A	B	B	B
polytherm S150	B	B	A	B		B
polytherm S200	B	B	A	B		B
polytherm S250	B	B	A	B		B
polytherm M170)	A	A	A	A		B
polycool MIX -25	A	A	A	B	A	B
polyclear MIX 30	A	A	A	A	A	A

A = Excellent B = Good

## RS232/RS485 Configuration

**Selecting RS232 or RS485 Communication** — Your Circulator may be configured for either RS232 or addressable RS485 serial communication. The selection is made on the COM sub-menu (see *Normal Operation, Selecting the Remote Communication and Control Protocol*).



**To Access:** Press the  key until COM and the currently selected protocol appears on the display.

**To Change:** To configure the Circulator for RS232 communication, touch the down arrow; to configure the Circulator for RS485 communication, touch a point between the down arrow and the word SET.

**To Accept:** Press . You will be prompted to select the communications baud rate.

**Selecting the Communications Baud Rate** — This sub-menu allows you to select the speed at which your Circulator will transmit data. The baud rate setting may be 1200, 2400, 4800, 9600, 19200, 38400, 57600, or 115200; the factory default is 9600.

	<p><b>NOTE:</b> When using RS232/RS485 communication, the Circulator's baud rate must match that of the connected device.</p>
---	---



Touch up arrow for fastest baud rate  
Touch down arrow for slowest baud rate

**To Change:** To select the 1200 baud rate setting, touch the bottom of the scroll bar; to select the 115200 setting, touch the top of the scroll bar. Rates between these two extremes are selected by touching the corresponding area of the scroll bar.



**To Accept:** Press . If you have selected RS232 communication, the Timer sub-menu will appear; if you have selected RS485 communication, you will be prompted to enter the desired RS485 address.

**Entering the RS485 Address** — When RS485 has been selected as the serial communications protocol, you will be prompted to enter the RS485 address after the baud rate has been selected. An address from 001 to 255 may be entered.



Touch and hold up/down arrows to make large changes  
Touch and release to make minor changes

**To Change:** Touch the touch scroll bar or touch the arrow symbols until the desired RS485 address is displayed.

**To Accept:** Press , , , or allow the LCD to return to the main operational display (approximately 10 seconds).

## RS232/RS485 Communications



**CAUTION:** Always turn electrical power to the Circulator OFF before making a connection to the serial (DB9) port.

Serial Connector — A DB9 connector is provided on the back panel of the Controller for RS232/RS485 data communication.

Pin	RS232	RS485
1		
2	TX	A
3	RX	
4	DTR	
5	GND	GND
6	DSR	
7	RTS	
8	CTS	B
9		

Serial Communications Protocol — The Controller uses the following serial communications settings:

Data bits — 8

Parity — None

Stop bits — 1

Flow control — None

Baud rate — Selectable (Controller/PC baud rates must match). 57600 is recommended.

Communications Commands — RS232 commands must be entered using the command only; RS485 commands must be entered using @ and the RS485 address (E.g., @001) followed by the actual command. All commands must be entered in the exact format shown. Do not send a [LF] (line feed) after the [CR] (carriage return). Be sure to follow character case exactly.

A response followed by an exclamation point (!) indicates that a command was executed correctly. A question mark (?) indicates that the Controller could not execute the command (either because it was in an improper format or the values were outside the allowable range). A response must be received from the Controller before another command can be sent. All responses are terminated with a single [CR].



**IMPORTANT INFORMATION REGARDING SERIAL COMMANDS ENTERED OVER ETHERNET VIA USER DATAGRAM PROTOCOL (UDP):** Only Read commands will be allowed when entering serial commands over Ethernet unless (1) Ethernet is configured as Unlocked and (2) the proper password is included as part of the serial command. See *Configuring the Ethernet Connection*.

Set commands entered over Ethernet must include Pxxx immediately following the serial command. For example, to change set point, enter the following command: **SSiii.iiPxxx [CR]** where:

**SS** = Set set point

**iii.ii** = set point value

**P** = password identifier

**xxx** = password

**[CR]** = carriage return

Command	Format	Values	Return Message
Set Command Echo	SEi[CR]	Echo: i = 1 No Echo: i = 0	![CR]
Set Set Point	SSiii.ii[CR]	i = any integer from 0-9	![CR]
Set On Off	SOi[CR]	On: i = 1 Off: i = 0	![CR]
Set High Alarm	SHiii[CR]	i = any integer from 0-9	![CR]
Set Low Alarm	SLiii[CR]	i = any integer from 0-9	![CR]
Set Pump Speed	SMi[CR]	i = any integer from 5-100 in increments of 5	![CR]
Set Restart Power Status	SWi[CR]	Restart: i = 1 Standby: i = 0	![CR]
Set Internal / External Control	SJi[CR]	External: i = 1 Internal: i = 0	![CR]
Read Set Point Temperature	RS[CR]		iii.ii[CR]
Read Units of Operation	RU[CR]		C[CR] or F[CR]
Read Internal Temperature	RT[CR]		iii.ii[CR]
Read External Temperature	RR[CR]		iii.ii[CR]
Read Operating Status	RO[CR]	Running: i = 1 Standby: i = 0	i[CR]
Read High Alarm Setting	RH[CR]		iii[CR]
Read Low Alarm Setting	RL[CR]		iii[CR]
Read Pump Speed	RM[CR]	i = any integer from 5-100	i[CR]
Read Power Status	RW[CR]		i[CR]
Read Alarm Status	RF[CR]	No Faults: i = 0 Fault: i = 1	i[CR]
Read the Auto-Cool Set Point	RA[CR]		ii[CR]
Read the Firmware Version	RB[CR]		viii[CR]



## USB Data Logging

Data is stored in a CSV file that can be read in spreadsheet programs such as Microsoft Excel®. The data is output in the following format:

MIN.SEC	[V]	UNIT	SET	P1	P2
4	[v0013]	C	10	15.19	14.89
4	[v0013]	C	10	15.18	14.88
4.22	[v0013]	C	10	15.03	14.71
4.23	[v0013]	C	10	15.02	14.7
4.24	[v0013]	C	10	15	14.69
4.25	[v0013]	C	10	15	14.69
4.26	[v0013]	C	10	14.99	14.68
4.27	[v0013]	C	10	14.98	14.67

MIN.SEC = Minutes and seconds.

V = Firmware version.

UNIT = Selected temperature unit.

SET = Temperature set point

P1 = Fluid temperature as measured by the Internal probe

P2 = Fluid temperature as measured by the External probe (if connected)



**NOTE:** The time stamp on the first line of data represents the time when data began being logged. The time stamp will indicate 0.01 if data logging was enabled after a flash drive or computer was connected to the USB port. It will show a later time if data logging was enabled before the storage device was connected. In the example shown above, the flash drive was connected to the USB port 4 minutes after data logging was enabled.

## USB B Setup, Monitoring, and Control

The Advanced Digital Temperature Controller can be monitored and controlled using a personal computer connected to its USB B port.

### Initial Setup

1. Select USB as the COM protocol (see *Normal Operation, Selecting a Remote Communication and Control Protocol*).
2. Plug the USB A connector of a USB A to USB B cable into an open USB port on the personal computer and plug the USB-B connector into the corresponding port on the Temperature Controller.
3. The computer operating system will automatically detect a new device and ask to install the drivers for the device. The drivers are located on the Resource Disk that came with your Temperature Controller.
4. Place the Resource Disk in the computer's CD drive and install the drivers.
5. Determine the identity of the communications port your computer assigned to the Temperature Controller.

## Monitoring and Control

When all connections have been made and drivers installed, you can begin monitoring and control the Temperature Controller using a terminal program and the active serial communications commands.

## Configuring the Ethernet Connection



**NOTE:** The Advanced Digital Controller's supports Ethernet communication using User Datagram Protocol (UDP).

The Advanced Digital Controller may be connected directly to a laptop or desktop computer via its Ethernet connection or indirectly via your facility's wired or wireless network. Either type of connection enables you to control and/or monitor the operation of your circulating bath using User Datagram Protocol (UDP). The Controller's active serial communications commands are used to retrieve and/or change operational information.

### Direct Computer to Controller Configuration





**NOTE:** If your computer is already connected to a wired network, you will not be able to directly connect it to your circulating bath's Temperature Controller.

1. Open the utility that displays your computer's available network connections.
2. Select an available wired connection.
3. Enter the following properties for the selected connection:
  - A. Internet protocol: TCP/IP
  - B. IP address: any three sets of identical numbers (e.g., 111.111.111) followed by a single digit (e.g., 111.111.111.5).
  - C. Subnet mask: 255.255.255.0
4. Enter the IP address into your Controller as outlined in *Fixed IP Addressing*, below. Please note that the first three series of numbers in IP address on the Controller must match those entered in Step 3B, above. The last number does not have to match.

### Wired or Wireless Network Configuration

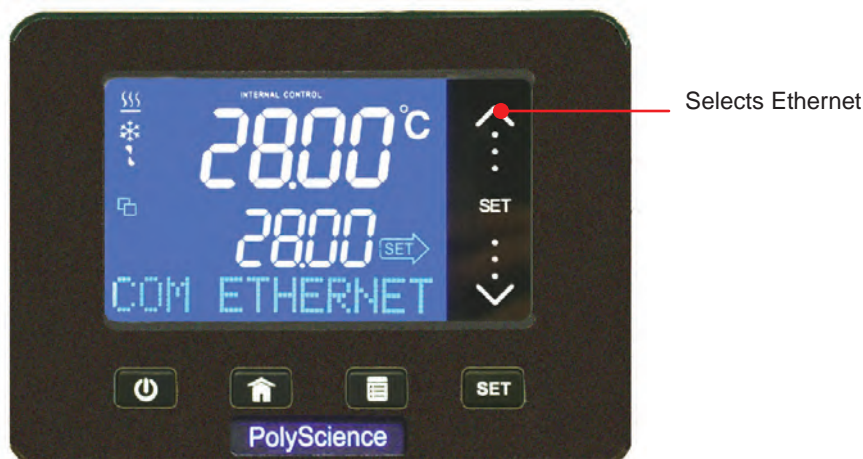
The Advanced Digital Controller supports both dynamic (DHCP) and fixed IP configuration. With either type of IP configuration, it may be necessary to work with your IT department to ensure that both the network and your Controller are configured properly.



**To Access:** Press the  key until COM and the currently selected protocol appears on the display.

**To Change:** Touch the up arrow to select Ethernet.

**To Accept:** Press . A screen allowing you to select whether only Read commands will be allowed or if both Read and Set commands will be allowed will appear.



SET LOCKED – Read Commands Only Permitted



UNLOCK – Set and Read Commands Permitted

	<p><b>IMPORTANT:</b> When Unlock is selected, a three digit numeric field will also appear. This field serves as a password that must be entered along with Set commands in order for the command to be executed.</p> <p>For example, the serial command required to change set point via Ethernet is: <b>SSiii.iiPxxx [CR]</b> where:</p> <ul style="list-style-type: none"> <li><b>SS</b> = Set set point</li> <li><b>iii.ii</b> = set point value</li> <li><b>P</b> = password identifier</li> <li><b>xxx</b> = password</li> <li><b>[CR]</b> = carriage return</li> </ul>
--	---

**To Change:** Use the touch scroll bar to change the displayed selection and, if Unlock is selected, also enter the password that will be used when executing Set commands over Ethernet. You may enter any numerical value from 100 to 255 as your password.

**To Accept:** Press . A screen displaying Fixed or dynamic (DHCP) Ethernet will appear.





**To Change:** Touch the down arrow to select Fixed IP; touch the up arrow to select DHCP IP.

**To Accept:** Press . The IP address for the selection will appear. If Fixed is selected, you will be allowed to change the IP address (see *Fixed IP Addressing*). If DHCP is selected, you will be allowed to view, but not change, the IP address (see *Dynamic IP Addressing*).

**Fixed IP Addressing** — If your Controller will be connected directly to a computer or your network uses fixed IP addressing, you must manually enter the IP address that will be used into your Controller. This is done as follows:

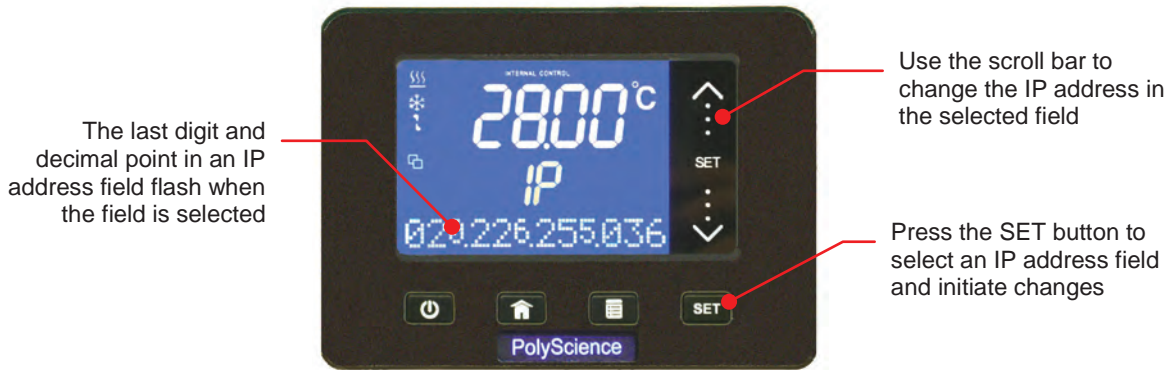
1. Select Fixed IP, select SET LOCKED or UNLOCKED, and then press . The IP address screen will be displayed.





**To Change:** Press . The last digit and decimal point in the first field of the IP address will begin flashing. Use the scroll bar to enter the correct IP address for that field and press  to advance to the next address field. Repeat until the desired values for all IP address fields have been entered.

**To Accept:** Press . The network mask screen will appear.

2. Enter the network mask address.



**To Change:** Press . The last digit and decimal point in the first field of the network mask will begin flashing. Use the scroll bar to enter the correct network mask for that field and press  to advance to the next field. Repeat until the desired values for all network mask fields have been entered.

**To Accept:** Press . The router address screen will appear.

3. Enter the router address.

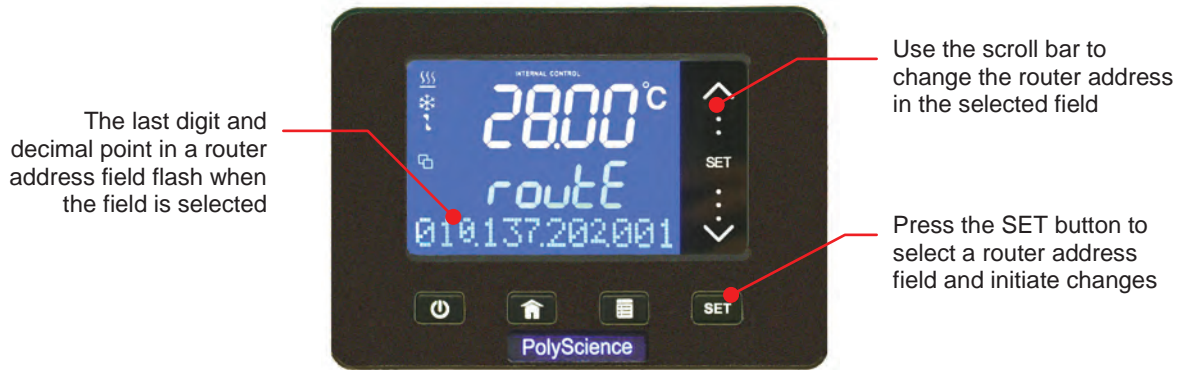

**To Change:** Press **SET**. The last digit and decimal point in the first field of the router address will begin flashing. Use the scroll bar to enter the correct router address for that field and press **SET** to advance to the next address field. Repeat until the desired values for all router address fields have been entered.

**To Accept:** Press **☰**.

**Dynamic IP Addressing** — If your network uses DHCP (Dynamic Host Configuration Protocol), the IP address, network mask address, and router address will be assigned automatically. Addressing is assigned as follows:

1. Configure Ethernet communication as outlined in Wired or Wireless previously.
2. Turn power to the Controller OFF using the power switch / circuit breaker on the rear of the unit.
3. Turn power to the Controller back ON.

	<b>NOTE:</b> This power down sequence is only required the first time the Controller is configured for DHCP.
--	--

To view the assigned addresses, select ETH DHCP, select SET LOCKED or UNLOCKED, and then press **☰**. The IP address screen will appear. Continue pressing **☰** to scroll to the network mask and router address screens.



Press the SET button to advance to subsequent address screens.

## Equipment Disposal (WEEE Directive)

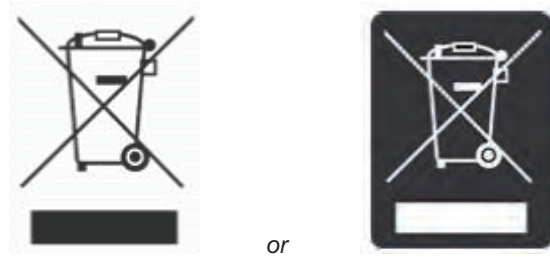

This equipment is marked with the crossed out wheeled bin symbol to indicate it is covered by the Waste Electrical and Electronic Equipment (WEEE) Directive and is not to be disposed of as unsorted municipal waste. **Any products marked with this symbol must be collected separately, according to the regulatory guidelines in your area.**

It is your responsibility to correctly dispose of this equipment at lifecycle-end by handing it over to an authorized facility for separate collection and recycling. It is also your responsibility to decontaminate the equipment in case of biological, chemical and/or radiological contamination, so as to protect the persons involved in the disposal and recycling of the equipment from health hazards. By doing so, you will help to conserve natural and environmental resources and you will ensure that your equipment is recycled in a manner that protects human health.

Requirements for waste collection, reuse, recycling, and recovery programs vary by regulatory authority at your location. Contact your local responsible body (e.g., your laboratory manager) or authorized representative for information regarding applicable disposal regulations.

## Replacement Parts and Accessories

Description	Part Number
IEC to IEC Power Cord (Refrigerating/Heating Circulators) 120V, 60Hz	225-661
IEC to Mains Power Cord, U.S. plug type, 120V, 60Hz (7 to 28 liter Refrigerating/Heating Circulators)	225-473
IEC to Mains Power Cord, U.S. plug type, 230V, 60Hz (45 liter Refrigerating/Heating Circulators)	225-230
IEC to Mains Power Cord, European plug type, 240V, 50Hz (Refrigerating/Heating Circulators)	225-346
IEC to Mains Power Cord, U.S. plug type, 120V, 60Hz (Heating Circulators)	225-227
IEC to Mains Power Cord, European plug type, 240V, 50Hz (Heating Circulators)	225-228
Refrigeration Control Cable (Refrigerating/Heating Circulators)	225-651
Reservoir Cover for 7L Refrigerating/Heating and Heat only Circulators	510-726
Reservoir Cover for 15L Refrigerating/Heating and Heat only Circulators	510-727
Reservoir Cover for 20L Refrigerating/Heating and Heat only Circulators	510-728
Reservoir Cover for 28L Refrigerating/Heating and Heat only Circulators	510-729
Reservoir Cover for 45L Refrigerating/Heating and Heat only Circulators	510-730
Bath Cover for 6L Stainless Steel Open Bath	510-700
Bath Cover for 10L Stainless Steel Open Bath	510-701
Bath Cover for 20 and 28L Stainless Steel Open Baths	510-702
Lid for Viscosity Tube Opening, round, 2.25 inch diameter	300-760
Lid for Viscosity Tube Opening, square, 3.5 inch	300-758
Viscosity Bath Top with 5 round holes and hole covers (for 29L Viscosity Bath)	510-707
Viscosity Bath Top with 9 round holes and hole covers (for 29L Viscosity Bath)	510-708
Viscosity Bath Top with 3 square holes and hole covers (for 29L Viscosity Bath)	510-709
Lid for Cooling Coil Opening, round, 3.63 inch diameter (for 10L, 20L and 28L Stainless Steel Open Baths and 17L, 23L and 28L Polycarbonate Open Baths)	300-749
Lid for Cooling Coil Opening with slots for cooling coil; round, 3.63 inch diameter (for 10L, 20L and 28L Stainless Steel Open Baths and 17L, 23L and 28L Polycarbonate Open Baths)	300-779
Cooling Coil Kit for 10L, 20L and 28L Stainless Steel Open Baths and 17L, 23L and 28L Polycarbonate Open Baths	510-649
Bypass Tubing Kit, Buna N	510-711
Bypass Tubing Kit, Viton	510-495
Teflon-lined Tubing, stainless steel overbraid	060310
RS232 Cable	225-173
USB A to USB B Cable, 9-ft (3 m)	225-669
Ethernet cable, 9-ft (3 m)	225-670
Flash Drive, 1 GB	250-096
Pt100 External Temperature Probe, 2-ft (0.6 m)	525-876

<b>Description</b>	<b>Part Number</b>
Pt100 External Temperature Probe, 10-ft (3 m)	525-870
Pt100 External Temperature Probe, 25-ft (7.6 m)	525-871
Pt100 External Temperature Probe, 50-ft (15 m)	525-872
Fitting, ¼" male NPT to 1/8" (3 mm) hose barb, brass (set of 2)	060306
Fitting, ¼" male NPT to 3/16" (5 mm) hose barb, stainless steel (1 each)	776-204
Fitting, ¼" male NPT to 3/16" (5 mm) hose barb, nylon (1 each)	300-049
Fitting, ¼" male NPT to 3/16" (5 mm) hose barb, brass (1 each)	776-193
Fitting, ¼" male NPT to ¼" (6 mm) hose barb, nylon (1 each)	300-048
Fitting, ¼" male NPT to ¼" (6 mm) hose barb, brass (1 each)	776-194
Fitting, ¼" male NPT to ¼" (6 mm) hose barb, stainless steel (1 each)	776-203
Fitting, ¼" male NPT to 5/16" (8 mm) hose barb, brass (set of 2)	060305-2
Fitting, ¼" male NPT to 3/8" (9.5 mm) hose barb, stainless steel (1 each)	776-202
Fitting, ¼" male NPT to 3/8" (9.5 mm) hose barb, nylon (1 each)	300-047
Fitting, ¼" male NPT to 3/8" (9.5 mm) hose barb, brass (1 each)	776-195
Fitting, ¼" male NPT to M16 x 1, stainless steel (1 each)	775-290
Fitting, M16 x 1 female to 8 mm (1/4") hose barb, brass (1 each)	776-191
Fitting, M16 x 1 female to 12 mm (7/16") hose barb, brass (1 each)	776-192
Fitting, ½" male NPT x ½" (13 mm) hose barb, nylon (for integrated cooling coil)	300-096
Flow Adapter, 2 ports with shutoffs. ¼" male NPT x two ¼" (6 mm) hose barbs, brass	510-666
Digital to Analog Adapter, 10 mV	215-471
Reusable Air Filter for AD7LR-20 Refrigerating/Heating Circulator	305-057
Reusable Air Filter for AD07R-20 Refrigerating/Heating Circulator	305-054
Reusable Air Filter for AD15R-30 and AD20R-30 Refrigerating/Heating Circulators	305-055
Reusable Air Filter for AD45R-20 Refrigerating/Heating Circulator	305-056
O-Ring, Drain Valve (for Refrigerating/Heating and Heat only Circulators)	400-934
Drain Cap for Polycarbonate Viscosity Baths	510-756
Display Module Assembly	510-529
Bezel for Display	300-676
Circuit Breaker / Power Switch	215-330
Leveling Glide; Refrigerating/Heating and Heat only Circulators	400-814
Plastic Foot; Stainless Steel Open Baths	400-063
Resource Disk (with Operator's Manual)	110-815



## PolyScience Circulating Bath Fluids

Circulating Bath Fluids	Quantity	Part Number
polyclean Algaecide	8 oz / 236 ml	004-300040
polyclean Algaecide	Twelve 8 oz / 236 ml bottles	004-300041
polyclean Bath Cleaner	8 oz / 236 ml	004-300050
polyclean Bath Cleaner	Twelve 8 oz / 236 ml bottles	004-300051
polycool EG -25 (ethylene glycol)	1 gal / 4.5 liter	060340
polycool PG -20 (propylene glycol)	1 gal / 4.5 liter	060320
polycool HC -50 (water-based heat transfer fluid)	1 gal / 4.5 liter	060330
polytherm S150 (silicone oil)	1 gal / 4.5 liter	060326
polytherm S200 (silicone oil)	1 gal / 4.5 liter	060327
polytherm S250 (silicone oil)	1 gal / 4.5 liter	060328
polytherm M170 (mineral oil)	1 gal / 4.5 liter	060321
polycool MIX -25 (50/50 blend polycool EG -25 / H <sub>2</sub> O plus polyclean algaecide)	Five 0.5 gal / 2.27 liter	004-300060
polyclear MIX 30 (distilled water plus polyclean algaecide)	Five 0.5 gal / 2.27 liter	004-300062

## Service and Technical Support

If you have followed the troubleshooting steps outlined previously and your Circulator still fails to operate properly, contact the supplier from whom the unit was purchased. Have the following information available for the customer service person:

- Model, Serial Number, and Voltage (from back panel label)
- Date of purchase and purchase order number
- Supplier's order number or invoice number
- A summary of the problem

## Warranty

The manufacturer agrees to correct for the original user of the product, either by repair (using new or refurbished parts), or at the manufacturer's election, by replacement (with a new or refurbished product), any defects in material or workmanship which develop during the warranty period. The standard warranty is twenty-four (24) months after delivery of the product. In the event of replacement, the replacement unit will be warranted for the remainder of the original warranty period or ninety (90) days, whichever is longer. For purposes of this limited warranty, "refurbished" means a product or part that has been returned to its original specifications. In the event of a defect, these are your exclusive remedies.

If the product should require service, contact the manufacturer's/supplier's office for instructions. When return of the product is necessary, a return authorization number is assigned and the product should be shipped, transportation charges pre-paid, in either its original packaging or packaging affording an equal degree of protection to the indicated service center. To insure prompt handling, the return authorization number must be placed on the outside of the package. A detailed explanation of the defect should be enclosed with the item.

The warranty shall not apply if the defect or malfunction was caused by accident, neglect, unreasonable use, improper service, acts of God, modification by any party other than PolyScience, or other causes not arising out of defects in material or workmanship.

**EXCLUSION OF IMPLIED WARRANTIES.** THERE ARE NO WARRANTIES, EXPRESSED OR IMPLIED, INCLUDING, BUT NOT LIMITED TO, THOSE OF MERCHANTABILITY OR FITNESS FOR A PARTICULAR PURPOSE WHICH EXTEND BEYOND THE DESCRIPTION AND PERIOD AS STATED IN THE OPERATOR'S MANUAL INCLUDED WITH EACH PRODUCT.

**LIMITATION ON DAMAGES.** THE MANUFACTURER'S SOLE OBLIGATION UNDER THE WARRANTY IS LIMITED TO THE REPAIR OR REPLACEMENT OF A DEFECTIVE PRODUCT AND POLYSCIENCE SHALL NOT, IN ANY EVENT, BE LIABLE FOR ANY INCIDENTAL OR CONSEQUENTIAL DAMAGES OF ANY KIND RESULTING FROM USE OR POSSESSION OF THIS PRODUCT.

Some states do not allow: (A) limitations on how long an implied warranty lasts; or (B) the exclusion or limitation of incidental or consequential damages, so the above limitations or exclusions may not apply to you. This warranty gives you specific legal rights and you may have other rights that vary from state to state.