

# 01 Disclaimer

## USER MANUAL PLATINUM Brushless Electronic Speed Controller Platinum 150A V5



Thank you for purchasing the Platinum 150A ESC! Please read the following statement carefully before use and, once used, it is considered to be an acceptance of all the contents. Please strictly observe and adhere to the manual installation with this product. Unauthorized modification may result in personal injury and product damage. We reserve the rights to update the design and performance of the Product without notice. Different languages are available. Chinese language will be available to the mainland of China while English language will be available to the rest of the world.

# 02 Safety precautions

- Before using this product, read the instruction manual carefully. Ensure that the equipment is used appropriately to avoid damaging the ESC. The wrong usage will overheat the motor and may damage the electronics;
- It is important to ensure that all wires soldered are properly secured to avoid short circuits from happening. A good soldering station is recommended to do such a job to avoid overheating the circuit board as well as to ensure connections are properly welded;
- Even though the product has relevant protective measures, always use it in a safe manner in accordance with the operating environment noted in the manual (e.g. voltage, current, temperature and etc);
- Always remember to disconnect the battery each time after using it. Failure to do so will cause the battery to be completely discharged, resulting in an unpredictable danger.

# 03 Product features

- The two-windows open structure helps to further enhance the cooling efficiency on the ESC;
- The Platinum 150A ESC is equipped with a high-power switch regulated BEC, with a continuous output current of 10A, an instantaneous current of up to 30A. The BEC module and other circuits are independent;
- Equipped with the synchronous rectifier driver efficiency optimization technology (DEO—Driving Efficiency Optimization), the throttle response is more linear, drives more efficiently and is temperature efficient;
- There are 4 flight modes: Fixed-wing mode/helicopter external speed-setting mode/helicopter elf-speed mode/helicopter storage fixed-speed mode;
- The helicopter mode has a slow-start function;
- Equipped with the helicopter speed-control function, the speed sensitivity is adjustable and easy to operate. In the case of rapid load changes, the main rotor speed is stable and has excellent fixed speed;
- Equipped with the time selection function for stall landing, it can be manually adjustable within the time set to avoid a crash due to handling errors;
- The ESC is equipped with LED indicators to represent the statuses and fault warnings;
- Equipped with an output interface to showcase the motor speed output in real time;
- The ESC has a separate parameter setting interface which allows it to be connected to the LCD parameter set-up box or OTA module for parameter setting. Connecting it to the standard power supply of the thermal fan is possible as well;
- The flight data recording function is able to record the minimum voltage, maximum temperature, maximum current, calibration speed (requires OTA module and mobile phone app);
- OTA Bluetooth module supported. Changes to the parameter settings, software upgrading, data recording and other operations can be completed via the mobile phone (Apple and Android) APP;
- Built-in with multiple protections which effectively extends the life of the ESC.
  - start-up protection
  - temperature protection
  - capacitive temperature protection
  - overload protection
  - throttle signal loss protection
  - input voltage abnormal protection

# 04 Product specifications

Model	Platinum 150A V5
Continuous/instantaneous current	150A / 180A
Input voltage	3-8 lithium battery
BEC	Switch regulated BEC; output voltage 5.4-8.4V adjustable (adjusted 0.1V); output current 10A, instant 30A
The input/output wire	1 x black, 1x red 10AWG silicone wire / 3 x black 12AWG silicone wire welding 4mm gold plug
Independent parameter programming	Connect LCD setup box or OTA module, or to power the cooling fan
LED light	Display the statuses and fault alerts
Size/Weight	83 x 37 x 21mm / 140g
Mounting holes	M3-3mm, 37.5 x 16.5mm
The scope of application	550-580 class electric helicopter (main rotor length 550-580mm)

# 05 User Guide

## 1 Wiring diagram

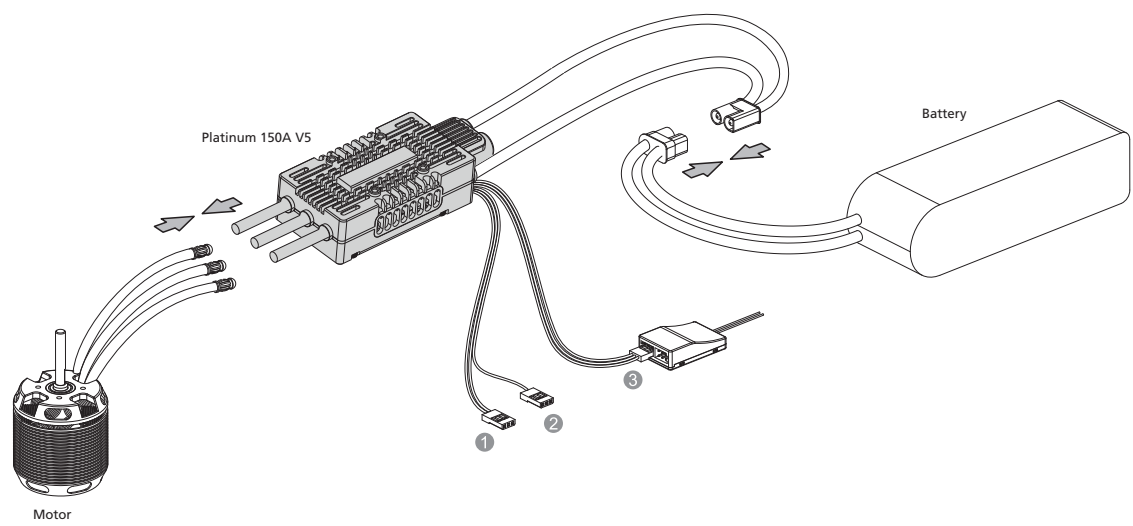

- BEC output wire (red, brown): The additional BEC output wire is plugged into the receiver battery dedicated channel or any available channel. (For better BEC power output, it is recommended to insert the BEC cable into a battery-specific channel or any available channel).
- RPM signal wire (yellow): Insert the speed input channel;
- Throttle signal wire (white, red, black): Insert into the receiver throttle channel. Depending on the receiver type, the white wire is to transmit the throttle signal, whereas the red and black lines are parallel to the output of the internal BEC (e.g. the BEC voltage output wire and ground wire).

## 2 Normal boot process

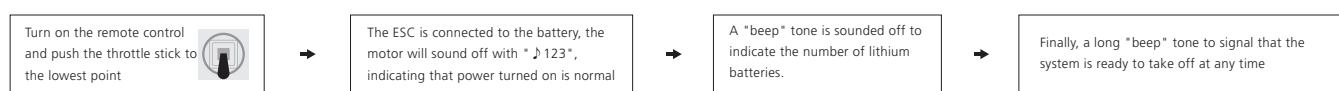

## 3 Throttle stroke calibration operation method

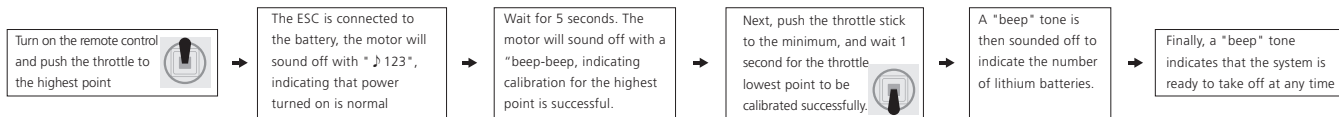

- Note:
- 1) The factory default value for the throttle travel of the ESC is 1100us-1940us (Futaba standard). The throttle travel should always be re-calibrated for the first time or when remote controls have been replaced.
  - 2) Before calibration, always have the throttle curve set to default. Ensure that the throttle value corresponds to the highest point(100%) of the remote control throttle and the lowest throttle point (0%).

# 06 Parameter setting and power-conditioning operation information viewing method

- 1) The ESC parameters can be programmed specifically to meet different flight needs.
- 2) The ESC will be able to record the calibration speed of the current flight (only in storage fixed speed mode), the minimal voltage, maximum temperature and other information. Please do not disconnect the power from the battery as the information will not be saved after the power has been disconnected. Connect LCD set-up box or OTA module to view.

## 1 First - The use of LCD setup box to program the parameters (need to purchase separately)

### 1. Wiring diagram:

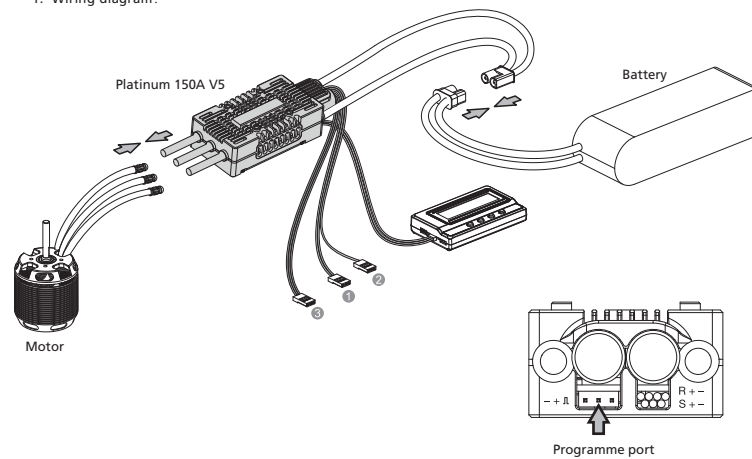

### 2. Set-up methods:

- 1) Connect the ESC to the LCD set-up box as shown above;
- 2) The current firmware version will be reflected once the power is turned on;
- 3) Press "ITEM" to browse through the parameters, and press "VALUE" to change the settings;
- 4) Press OK to save the settings;
- 5) Repeat step three and step four to modify the settings of other parameters;
- 6) Once completed, disconnect the ESC from the battery by switching off and unplugging the set-up box. Power up again and you are ready to run the new settings.

Note: Any parameter changes will require the ESC to be re-powered to take effect.

### 3. How to view the settings on the ESC:

- 1) Connect the ESC and LCD set-up box as shown above;
- 2) The version of the current firmware will be reflected once you have connected the LCD set-up box to the ESC;
- 3) Press "ITEM" to browse through the parameters, and press "VALUE" to change the settings.

## 2 \*OTA Module needs to be purchased separately

### 1. The connection diagram:

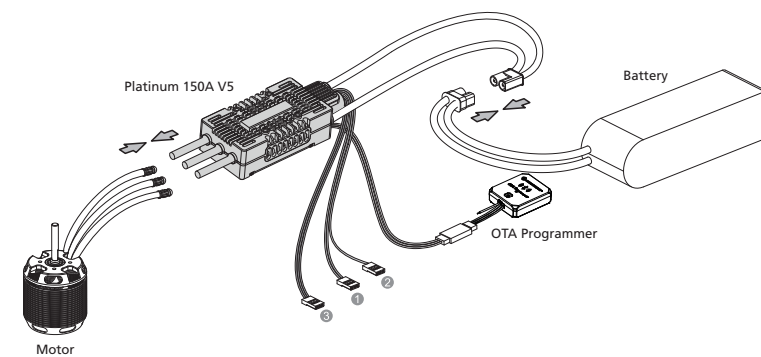

### 2. Set-up methods:

- 1) Connect the ESC and OTA setup box as shown above;
- 2) Turn on your phone's Bluetooth settings and connect to the OTA module;
- 3) Once connected, open "HW Link" software from the mobile phone and click on "connection" to make changes to the parameters, view data records and other operations;
- 4) Once completed, disconnect the ESC from the battery by switching off and unplugging the OTA module. Power up again and you are ready to run the new settings.

### 3. How to view the settings on the ESC:

- 1) Connect the ESC and OTA modules as shown above;
- 2) Turn on your phone's Bluetooth settings and connect to the OTA module;
- 3) Open "HW Link" and click on the icon to connect. Click on "data record" to select and "empty mode" to view the record data.

# 07 Programmable parameter items and instructions

## 1 Programmable parameters project

1) There are four flight modes, the adjustable parameters in each mode can be found in the table below:

Flight Mode	Fixed-wing	Helicopter (Linear Throttle )	* Helicopter (Elf Governor)	Helicopter (Store Governor)
LiPo Cells	Adjustable	Adjustable	Adjustable	Adjustable
Voltage Cutoff Type	Adjustable	Adjustable	Adjustable	Adjustable
Cutoff Voltage	Adjustable	Adjustable	Adjustable	Adjustable
BEC Voltage	Adjustable	Adjustable	Adjustable	Adjustable
Start-up Time	This feature is not available	This feature is not available	Adjustable	Adjustable
Governor Parameter P	This feature is not available	This feature is not available	Adjustable	Adjustable
Governor Parameter I	This feature is not available	This feature is not available	Adjustable	Adjustable
Auto Restart Time	This feature is not available	This feature is not available	Adjustable	Adjustable
Restart Acceleration Time	This feature is not available	This feature is not available	Adjustable	Adjustable
Brake Type	Adjustable	This feature is not available	This feature is not available	This feature is not available
Brake Force	Adjustable	This feature is not available	This feature is not available	This feature is not available
Timing	Adjustable	Adjustable	Adjustable	Adjustable
Motor Rotation	Adjustable	Adjustable	Adjustable	Adjustable
Active Freewheeling	Adjustable	Adjustable	Unable to adjust,forced to turn on	Unable to adjust,forced to turn on
Start-up Power	Adjustable	Adjustable	Adjustable	Adjustable

2) Programmable parameter items correspond to programmable setpoint tables:

Programmable Item	Parameter Value	Option 1	Option 2	Option 3	Option 4
1 Flight Mode	Fixed-wing		Helicopter (Linear Throttle )		
2 LiPo Cells	*Auto Calculation			3-8S	
3 Voltage Cutoff Type	*Soft Cutoff			Hard Cutoff	
4 Cutoff Voltage	Disabled			2.8V-3.8V (Default 3.0V)	
5 BEC Voltage	5.4-8.4V (Default 6V)				
6 Start-up Time	.4s-25s (Default 15s)				
7 Governor Parameter P	0-9 (Default 5)				
8 Governor Parameter I	0-9 (Default 5)				
9 Auto Restart Time	0s-90s (Default 25s)				
10 Restart Acceleration Time	1s-3s (Default 1.5s)				
11 Brake Type	*Disabled		Normal		Proportional
12 Brake Force	0-100% (Default 0%)				
13 Timing	0°-30° (Default 15°)				
14 Motor Rotation	*CCW			CCW	
15 Active Freewheeling	*Enabled			Disabled	
16 Start-up Power	1-7 (Default 3)				

The options marked with "\*" are the factory default settings.

## 2 Programmable parameters project description

1. Flight Mode
  - 1.1 Fixed-wing: Suitable for fixed-wing and multi-rotary aircraft. In this mode, the throttle has to be more than 5% (including 5%) to start the motor and the throttle response is rapid;
  - 1.2 Helicopter (Linear Throttle ): 1.2s/uitable for helicopter aircraft without any fixed speed equipment or helicopter aircraft using external speed control equipment. The throttle has to be higher than 5% (including 5%) before starting the motor. After the slow start is completed, the motor will start off in a smoother manner, followed by a faster throttle response accompanied to the current throttle value;
  - 1.3 Helicopter (Elf Governor): Suitable for helicopter aircraft flying at fixed speed. The throttle has to be higher than 40% (including 40%) before starting the motor. In the slow start process, the motor starts off in an ultra-smooth acceleration to complete the speed calibration;
  - 1.4 Helicopter (Store Governor): Suitable for the use of fixed speed flight helicopter aircraft. The throttle in this mode has to be more than 40% (including 40%) before starting the motor. The motor starts in an ultra-smooth manner, after the completion of slow start speed into the fixed speed operating state.
    - \*Note that speed calibration must be done each time other modes are switched to using this mode.
2. LiPo Cells
 

The number of battery cells can be calculated automatically and set manually. Select Auto-calculation to calculate the number of battery cells. Error on battery cells will be detectable during self-test and can be adjusted accordingly;
3. Voltage Cutoff Type
  - Soft shutdown: The output power will be gradually reduced to 50% of the total power output after low voltage protection is triggered;
  - Hard shutdown: Disconnect the power output immediately after low-current protection is triggered.
4. Cutoff Voltage
 

2.8V-3.8V with 0.1V step adjustability. When using 6 lithium batteries, the final protection voltage should be set by x6. The default is 3.0V;
5. BEC Voltage
 

The ESC is built-in with a BEC of 5.4-8.4V and has the capability to adjust 0.1V per step. Default 6.0V;
6. Start-up Time
 

Adjust the response speed of the throttle in "helicopter elf fixed-speed" or "storage speed mode". The higher the value, the slower the throttle response speed. 4-25 fully adjustable. Default is at 15;
7. Governor Parameter P
 

Control the degree of rotation while maintaining at fixed speed. The higher the value, the greater the degree of regression target speed when the speed is insufficient. Whereas, when the speed is too high, the function needs to be combined with the fixed speed sensitivity I settings;
8. Governor Parameter I
 

When the speed falls below, or exceeds the value set, the speed is compensated by the ESC. This parameter is used to resize the degree of rotation. Too large parameters will cause excessive make-up, too small parameters will cause insufficient replacement;

## 9. Auto Restart Time

This feature is only available in helicopter elf or storage fixed speed modes. It is the time set to push the throttle from more than 40% to 25% to 40% throttle range, and then push back more than 40%. The parameter will not take effect when the throttle range is below 25% or between 25%-40% beyond the set time. The ESC will execute the "helicopter elf / storage fixed speed" modes of the default start-up process only if the throttle range is above 40%;

## 10. Restart Acceleration Time

1-3 seconds, with 0.5 seconds step adjustability (default 1.5 seconds). This parameter controls the time required for the motor to accelerate from zero to full speed during a quick restart; (This is an auxiliary function and is only valid if the "time to turn off and land" function is valid)

## 11. Brake Type

11.1 Normal brake: This function will stop the motor from braking during operating according to the value set on the braking force;

11.2 Proportional brake: When set to this function, the throttle travel on the remote control is 20% - 100% corresponding to 0%-100% of the throttle output, and the throttle travel on the remote control is 20%-0% corresponding to the brake force 0-100%;

11.3 Reverse brake: When "Reverse brake" is turned on, the RPM signal is reversed. This is controlled by another channel in the remote control, and is required to have the same travel settings as the throttle channel (0-100%). The reversal signal must be in the range of 0-50% when the power is switched on. Push the trigger until the reverse signal is at the range of 50%-100%. The motor will brake to stop. Loss of throttle signal during operation will result in a total loss control.

## 12. Brake Force

The greater the value, the shorter the time taken for the motor to come to a standstill. 0-100%, with 1% step adjustability. (Default: 0). This function is only valid in normal brake mode;

## 13. Timing

Adjust the angle of the motor electronically. 0-30 degrees adjustable, 1 degree per step. The default is at 15 degrees;

## 14. Motor Rotation

Clockwise and counter-clockwise direction is adjustable from the ESC.

## 15. Active Freewheeling

Turn on synchronous rectification in "fixed-wing" or "helicopter external speed" mode to bring better throttle linearity;

## 16. Start-up Power

The greater the value, the stronger the start-up force. 1-7 adjustable with a default value at 3.

# 08 Fixed speed

## 1 Time to turn off and land

By speed calibration, the motor speed-throttle value corresponding curve is established. The throttle value is set to a fixed value on the remote control, (e.g. the output of the throttle value corresponds to the speed, and the motor load changes to maintain the same speed).

1) In the "helicopter elf fixed speed mode", the electricity will not store the motor speed-throttle value corresponding curve after power failure, so each time after the power is turned on, you have to perform a speed calibration, and then you can normally use the fixed speed function. In this mode, due to differences in battery discharge capacity, there will be subtle differences in the speed of each calibration, which will eventually lead to nuances in the speed of different batteries under the same throttle value, but will not affect the speed;

2) In "Helicopter Storage Fixed Speed Mode", the ESC stores the motor speed-throttle value corresponding curve after the speed calibration. After switching to "Helicopter Storage Fixed Speed" mode, you will need to perform a speed calibration after switching on for the first time. You will need to do a speed calibration each time after a save has been made in another mode. In "storage fixed speed" mode, you will always perform the saved motor speed-throttle value corresponding curve. The first speed calibration requires the use of a battery which is in a better state. When calibration is completed, replace a different battery of the capacity to fly again. The throttle value of the speed will maintain the same consistency to the flight before.

## 2 Speed calibration

### 1) The principle of speed calibration

During the speed calibration process, the ESC will be able to perform a motor speed-throttle value corresponding curve according to the actual input battery voltage combined with the actual KV value of the motor. Therefore, a fully charged battery is required during calibration so that helicopter do not take off.

The main rotor needs to be maintained at zero degrees.

Note: When the speed is calibrated, the main rotor pitch is maintained at 0 degrees and the throttle value is above 40% (50% recommended).

### 2) Speed calibration process

- 1) The user is advised to use the default throttle curve and pitch curve; (if you do not want to use the default settings, make sure that the throttle is at 50% when the motor is turned up and the main rotor pitch is 0 degrees)
- 2) After turning on your remote control, throttle must be in the lowest position and wait for the self-test to complete;
- 3) Lock the throttle once the throttle lock has been set. Push the throttle rocker to 50% and unlock the throttle after. Only if the throttle lock is not set, you can push the throttle to 50%;
- 4) The rotor of the helicopter will start to slowly accelerate (the main rotor pitch is zero degrees, the helicopter will not lift off, please note safety) and wait for the acceleration to complete. When the rotor speed is stable, lock the throttle lock or push the throttle stick to the minimal;
- 5) The ESC no longer drives the motor to rotate, the main rotor of the helicopter begins to slow down and stop;
- 6) Speed calibration is completed.

Note: Throttle stroke calibration should be done before the speed calibration.

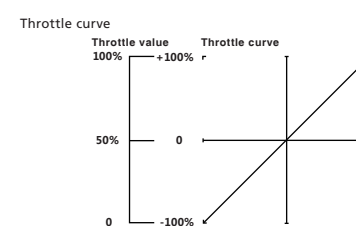

## 3 The fixed speed function settings

Note:

- 1) The recommended fixed speed throttle interval is between 70%-90%. Having a lower fixed speed throttle will make the ESC inefficient. While using a higher fixed speed throttle will have a small return space. Higher load may surface if the replacement speed is insufficient and will cause problem of rotation. If this happens, it is recommended to replace the motor or the gear ratio;
- 2) Helicopter storage fixed speed mode is required to use a battery that is in a better state in order to complete the speed calibration. Using a poor performance battery may damage the battery cells during the flight;
- 3) In storage fixed speed, different battery packs can be used as long as the number of cells inside will be able to bring a stable speed. However, battery packs with different numbers of cells will not be possible for usage. For example, when storing a fixed speed, you cannot calibrate it with a 45 battery pack and run it at the same speed with a 6S battery pack;
- 4) The PI parameters allow the user to make set-up to suit their needs. Connect your phone or PC to view the corresponding table for throttle and speed in the storage fixed speed mode.

1. In the "helicopter storage fixed speed mode" (does not have to be in "helicopter elf fixed speed mode"), you can see the calibration speed (Max RPM) each time the power is turned on. The calculated fixed speed throttle corresponding to the main speed is also more accurate. It is recommended to install the motor and gear ratio, battery with fixed number of cells.

Here's an example of the fixed speed setting in this mode:

- 1) Connect the LCD set-up box or OTA module after the speed calibration is completed to find the record as shown:
 

The values in the figure is just an example, depending on the actual display values. This value is the maximum electrical speed that the motor can achieve at 100% throttle.
- 2) Taking the helicopter of the first gearbox as an example, The motor has 10 poles, using 13T motor teeth with a main teeth of 120T. The gear ratio is at 9.3.

Formula: 100% throttle speed of the main rotor s/ Max RPM \* (motor poles +2) + tooth ratio

In the example, the main rotor 100% throttle speed is 157 x 1000 + (10+2) + (120+13) can be about 3400 rpm

3) If the main rotor during a 3D flight requires to be maintained at 2700 rpm, the fixed speed throttle needs to be set at 2700 + 3400 to get about 0.8. At 0.8, the throttle value needs to be set at 80%.

4) At this point, you need to set the throttle curve (e.g. IDLE1) to 80% of a horizontal line, as shown in the figure:

During the flight, the normal throttle curve can be cut to IDLE1 after taking off.

Note: In general, some advanced remote controls are allowed to set and save the IDLE settings for 2-3 sets of throttle curves (the pitches under each set of IDLE are adjusted according to actual needs), and you can switch these settings back and forth during the flight to meet the needs of setting multiple fixed speed throttles to meet different flight speed requirements (e.g. IDLE1 is set at 70% throttle, IDLE2 is 80% throttle, IDLE3 is 90% throttle. There are three different speed levels to meet different flight needs).

2. The user is required to set the remote control in advance as the Max RPM is not viewable in the "Elf fixed speed mode". However, it is possible to view the speed of the main rotor, and determine the needs to set the throttle value with the help from an external equipment (speed viewer).

Setting the throttle value to such that the motor is 480KV, 12S full-charge lithium battery, motor teeth 13T, main teeth 110T, so that the main rotor can get the maximum speed is: motor KV value\* battery voltage + The + tooth ratio is 480 x 12 x 4.2 x 13 +10 x about 2850 reverberations, to fly 2150ts, 2150 x 2850 x about 0.75 x 75% throttle. Adjust the speed according to what the speed viewer shows.

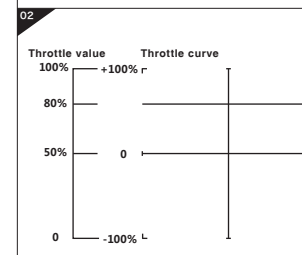
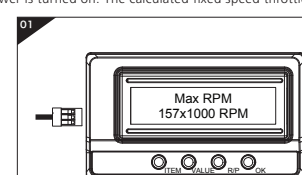

# 09 LED INDICATORS, WARNING TONES AND PROTECTION FUNCTION INSTRUCTIONS

## 1 LED indicators and warning notes

Protection	Tone	LED indicator	Instruction
The input voltage is not properly protected	*Beep, beep, beep, beep...*	Red LED, followed by the tone	The input voltage is not within the input voltage range
Throttle signal loss protection	*Beep, beep, beep, beep...*	Red LED, followed by the tone	The throttle signal input was not detected
The throttle rocker is not zero protected	*Beep, beep, beep, beep...*	Red LED, followed by the tone	The throttle value is not at 0% throttle
The throttle travel is too small for protection	*Beep, beep, beep, beep...*	Red LED, followed by the tone	When calibrating the throttle stroke, set the throttle travel too small
Temperature protection	*Beep beep, beep beep...*	Red LED, followed by the tone	The internal temperature of the ESC exceeds the protection temperature
Low current protection	*Beep beep beep, beep beep beep...*	Red LED, followed by the tone	The operating voltage is lower than the set protection voltage
Current protection	None	Red is always bright	The operating current is higher than the set current

## 2 The protection function description

1. Abnormal power-on voltage protection
 

The ESC enters a protective state once the input voltage detected is not in the operating range. Prompting LED light to flash;
2. Start-up protection
 

The start-up protection will be able to detect the motor speed from when the speed stops rising or the rising speed is unstable. If the throttle input is less than 15%, the ESC will try to restart automatically. (This may occur due to; Poor contact between the ESC and motor connections, individual output wires, faulty motor, propellers blocked by other objects, Binding gears, etc.)
3. Temperature protection
 

When the operating temperature of the ESC has exceeded 110 degrees Celsius, power will be gradually reduced for safety, but will not be turned off. There will still be up to 50% of power, to ensure that the motor has the power to land. After the temperature drops, the ESC will gradually be restored back to maximum power. ESC temperature must not exceed 70 degrees or it will not work. Prompting LED light to flash (above is the soft-off protection mode, if you choose hard-off, cut off the power directly)
4. Throttle signal loss protection
 

When the throttle signal is lost for more than 0.25 seconds, the output is immediately switched off to avoid further damage due to the propeller rotating at a high speed. Once the signal has been restored, the power output will be restored;
5. Overloading protection
 

When there is a sudden surge of current, power will be cut off and will be restarted. If the load is still abnormal after the restart, the power will be completely cut off;
6. Low current protection
 

When the operating voltage of the ESC has exceeded the protection voltage set, power will be gradually reduced for safety, but will not be turned off. There will still be up to 50% of power, to ensure that the motor has the power to land;
7. Current protection
 

The current will be cut off immediately once the set value has been breached.