

# Mix Modular 3-PC Sofa

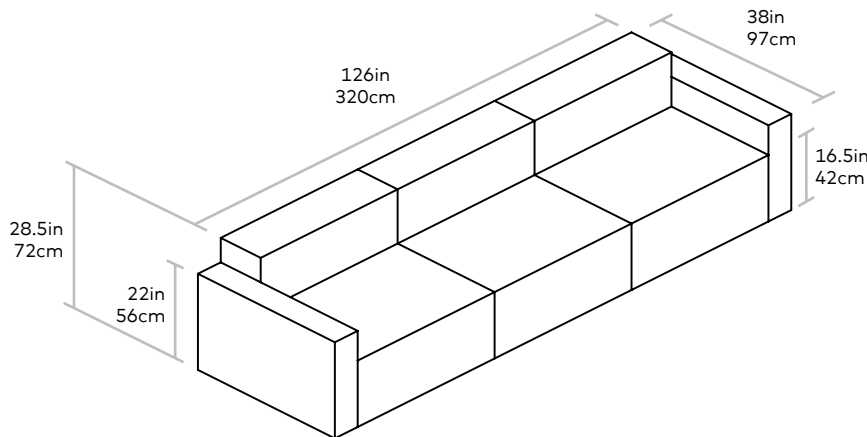

Seat Height 16.5in | 42cm  
Seat Depth 28in | 71cm



**UPHOLSTERY** > Fabric  
**BASE** > Inset Solid Wood Block Feet

The Mix Modular Collection lets you mix and match components and fabrics to build a custom sectional, sofa or seating group to perfectly suit your space. The design uses 8 basic components (Left Arm, Right Arm, Armless, Corner, Arc, Wedge, Ottoman and Block Table) which can be combined to create an unlimited number of seating configurations. Choose matching fabrics or mix things up to make it your own. Components can be easily reconfigured or added later to adapt to the changing needs of any home or workspace. The tight seat and back give the design a clean-lined, contemporary look, and each component has French seams to subtly soften the edges. Select components include a matching bolster cushion for added style and comfort. Constructed with kiln-dried 100% FSC®-Certified hardwood in support of responsible forest management.

**Build a custom sectional, sofa or seating group by combining the MIX Modular components below**

**ARM - LEFT FACING**  
W44 D38 H28.5 in  
W112 D97 H72 cm

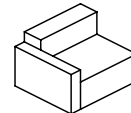

**ARM - RIGHT FACING**  
W44 D38 H28.5 in  
W112 D97 H72 cm

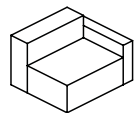

**ARMLESS**  
W38 D38 H28.5 in  
W97 D97 H72 cm

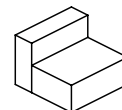

**CORNER**  
W38 D38 H28.5 in  
W97 D97 H72 cm

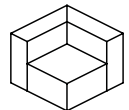

**WEDGE**  
W38 D38 H28.5 in  
W97 D97 H72 cm

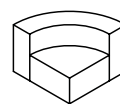

**OTTOMAN**  
W38 D38 H16.5 in  
W97 D97 H42 cm

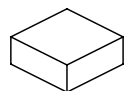

**ARC**  
W65 D38 H28.5 in  
W165 D97 H72 cm

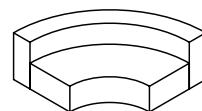

**BLOCK TABLE**  
W37 D14 H15 in  
W94 D36 H38 cm



To see all finish options visit  
[GUSMODERN.COM](http://GUSMODERN.COM)



THIS PRODUCT IS MANUFACTURED WITH FSC-CERTIFIED WOOD