

Facet-8 End Table



Pearl

Inspired by the shapes of naturally occurring crystals, the Facet-8 End Table is a sculptural design that functions beautifully as either an accent table or as secondary seating. Precision-cut panels are shaped into a unique geometric design, with faces that subtly reflect light to create an attractive, minimalist form. Exclusive, limited-edition colourways add a subdued touch of contemporary colour to any space. The design works as a standalone piece or in a grouping with other shapes and colours from the Facet Series.

Design Trade Professionals: We aim to keep our designs in stock and ready to ship quickly for projects on a tight timeline. Designs may be customized with COM and alternate finishes (minimum quantities may apply). Visit guscontract.com for more information about our Trade & Contract programs.

Facet-8 End Table

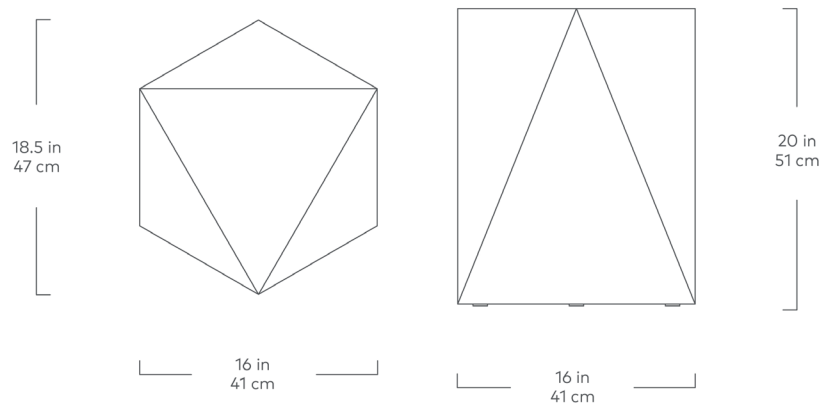

- Can work as a standalone piece or can be grouped together.
- Geometric designs are inspired by the shapes of naturally occurring crystals.
- CNC-cut engineered wood panels are shaped into three distinctive patterns.
- Each stool features engineered wood surrounding a hollow core encased in white lacquer.
- Engineered wood has a matte spray finish with a subtle satin sheen.
- Felt pads on base help prevent floor damage.
- Recommended as secondary seating.
- CARB (California Air Resources Board) Phase II compliant.

