



aimshop

• LAP TIMERS • LOGGERS • CAMERAS • DASHES • SENSORS • AND MORE

SHOP NOW



SB TOUCH screen / Schermo tattile SB

Pantalla táctil SB / Ecran TACTILE SB

Code : 9000 000 00010



VISIT SUPPORT CENTER

SOFTWARE DOWNLOADS

FIRMWARE UPDATES

PRODUCT DOCUMENTATION



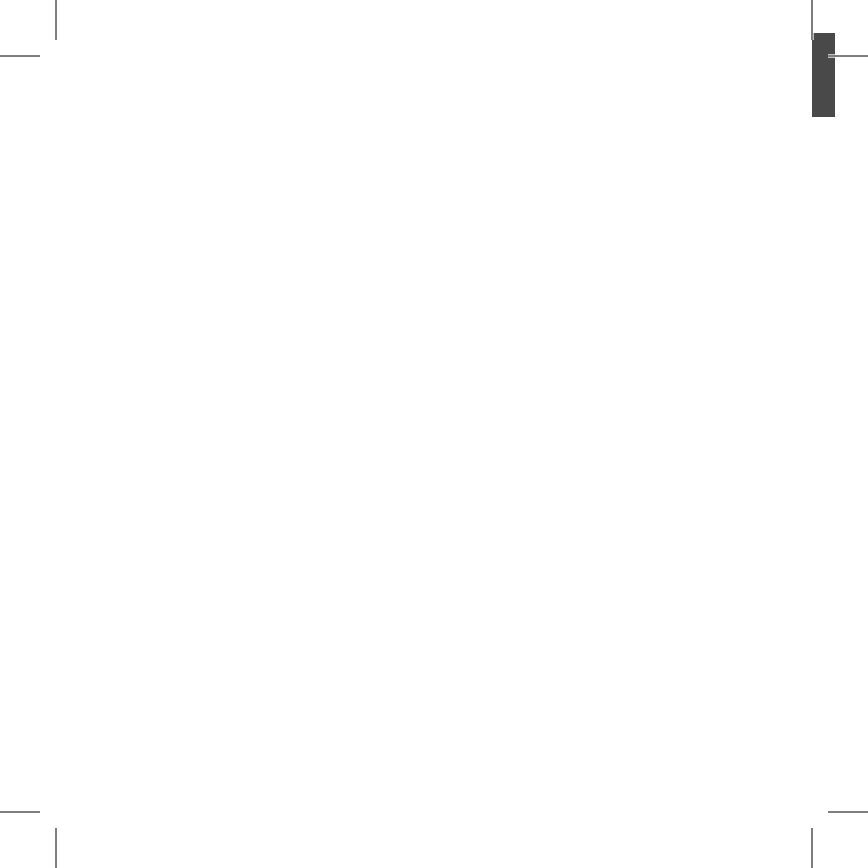

NOT_TOUCH_SB-01

TECHNICAL SPECIFICATIONS

<i>Supply voltage range</i>	8DC to 35VDC
<i>Supply current</i>	80mA (max) / 6mA (SLEEP mode)
<i>Front display</i>	2,4-inch TFT color screen with 320x240 pixel resolution
<i>Functionalities</i>	Voltage, current, State Of Charge (SOC), charge & discharge time remaining, adjustable brightness, automatic SLEEP mode, 6 languages (DE, EN, FR, IT, NL, SP)
<i>Operating temperature</i>	-10°C to +50°C
<i>Storage temperature</i>	-20°C to +70°C
<i>Relative humidity</i>	10% to 70%
<i>Presentation</i>	Flush-mounting device
<i>Dimensions</i>	Front Ø 93mm / Body Ø 72mm / Depth 27mm
<i>Fixing</i>	4 screws
<i>Weight</i>	110 g
<i>Protection class</i>	IP20 - P65 for front panel only
<i>Network protocol & connector</i>	CANBus / RJ11
<i>Standards</i>	EMC directive 2004/108/EC and LVD 2006/95/EC

NOT_TOUCH_SB-01

MOUNTING GUIDE

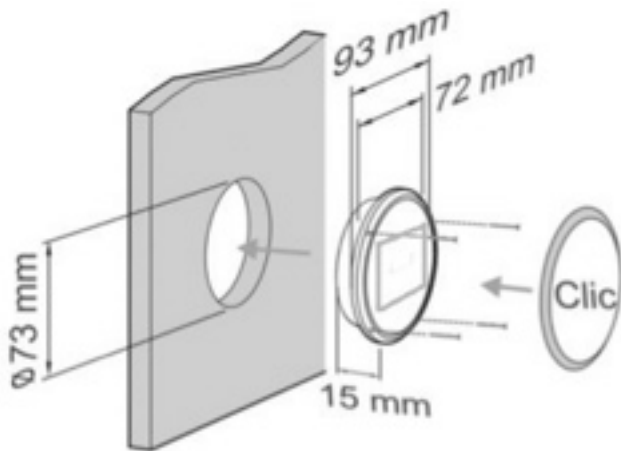

NOT_TOUCH_SB-01

AUTOMATIC IDENTIFICATION

If case of a battery with an ID010, the Touch goes into an automatic identification mode

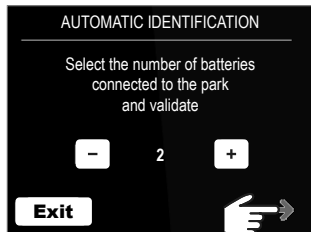

!!! Warning, the identification is done battery by battery. The first battery is connected, the identification done, then the second, then the third, etc.... A 120 Ohms resistor is plugged on the communication port of the battery during the identification.

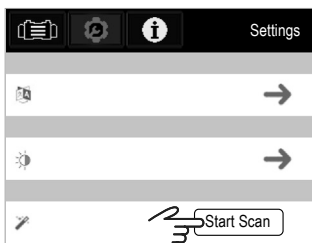
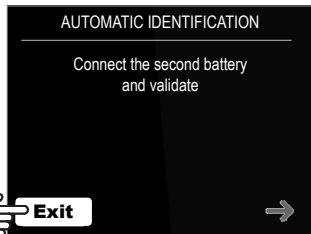

If a problem occurs during the identification (or if several batteries have the same ID), press **Exit** and then **Start Scan** during 10 to 15 seconds. A new automatic identification can start again.

NOT_TOUCH_SB-01

SETTINGS

Language



Brightness & delay before "SLEEP mode" (10 minutes in the example below)

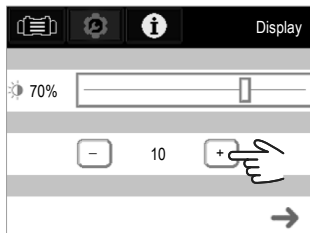
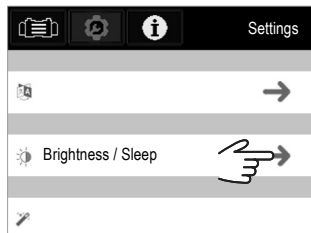

Note : Press for 2 sec on the screen to exit "SLEEP mode"

NOT_TOUCH_SB-01

Network scan (in case of problem with the network communication)

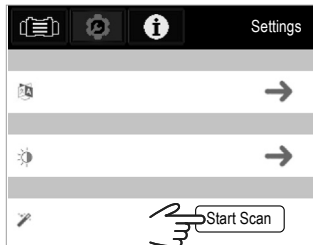

SINGLE BATTERY

Screen datas

<i>STATUS (battery)</i>	OK
<i>State Of Charge (SOC)</i>	69%
<i>Charge / Discharge</i>	CHARGE
<i>Current & Voltage (alternatively)</i>	25A 13V
<i>Time remaining before charged or discharged</i>	2h

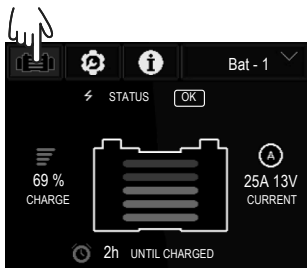

NOT_TOUCH_SB-01

BATTERY BANK

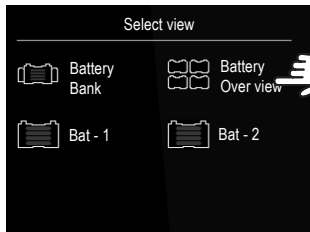

Screen datas

State of charge Bat-1	60%
State of charge Bat-2	55%
Voltage	13,2V
Current	5A

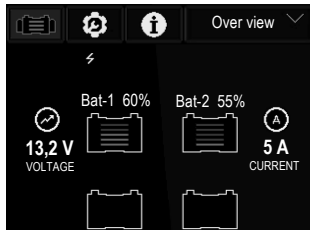

NOT_TOUCH_SB-01

TECHNISCHE SPECIFICATIES

<i>Spanningsbereik</i>	8DC tot 35VDC
<i>Stroom</i>	80mA (max) / 6mA (SLEEP mode)
<i>Schermscherm voorkant</i>	2,4-inch TFT kleurenscherm met 320x240 pixel resolutie
<i>Functionaliteiten</i>	Spanning, stroom, SOC (State Of Charge), laden & ontladen, resterende duur, helderheid, automatische SLEEP mode, 6 talen (DE, EN, FR, IT, NL, SP)
<i>Bedrijfstemperatuur</i>	-10°C tot +50°C
<i>Opslagtemperatuur</i>	-20°C tot +70°C
<i>Relatieve vochtigheid</i>	10% tot 70%
<i>Presentatie</i>	Inbouwapparaat
<i>Afmeting</i>	Vorkant Ø 93mm / Body Ø 72mm / Diepte 27mm
<i>Montage</i>	4 schroeven
<i>Gewicht</i>	110 gram
<i>Beschermingsklasse</i>	IP20 - IP65 voor voorkant
<i>Netwerk protocol & connector</i>	CANBus / RJ11
<i>Standaarden</i>	EMC directive 2004/108/EC en LVD 2006/95/EC

NOT_TOUCH_SB-01

MONTAGE

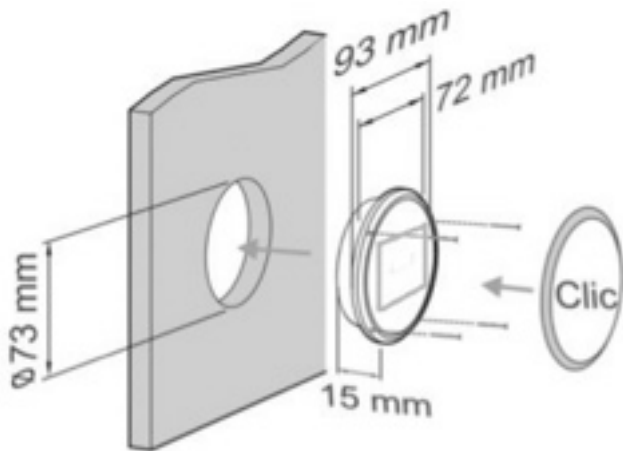

NOT_TOUCH_SB-01

AUTOMATISCHE IDENTIFICATIE

Bij een accu met een ID010, schakelt het display in automatische identificatie modus.



!!! Waarschuwing, de identificatie gebeurt accu voor accu. De eerste accu wordt aangesloten, de identificatie volgt, dan de tweede, dan de derde, etc. Een 120 Ohms weerstand wordt tijdens de identificatie in de communicatiepoort van de accu gepluigd.

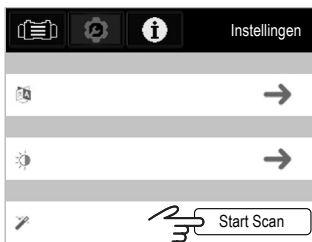

Als zich een probleem voordoet tijdens de installatie (of wanneer meerdere accu's dezelfde ID hebben), druk dan op **Exit** en dan **Start Scan** gedurende 10 tot 15 seconden. De automatische identificatie zal dan opnieuw starten.

NOT_TOUCH_SB-01

INSTELLINGEN

Taal

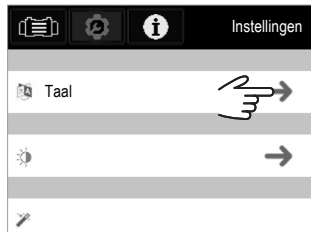

Helderheid & vertraging voor de slaapstand (10 minuten in onderstaand voorbeeld)

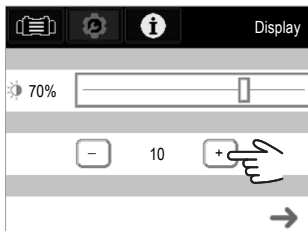

Noot : Druk 2 sec op het scherm om de slaapstand te verlaten

NOT_TOUCH_SB-01

Network scan (in het geval u problemen met de netwerk communicatie ondervindt)

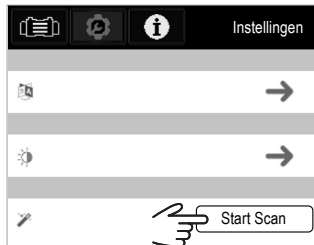

ENKELE ACCU

Scherminformatie

<i>STATUS (accu)</i>	OK
<i>State Of Charge, % opgeladen</i>	69%
<i>Laden / Ontladen</i>	LADEN
<i>Spanning en stroom</i>	25A 13V
<i>Resterende duur voordat accu geladen moet worden</i>	2h

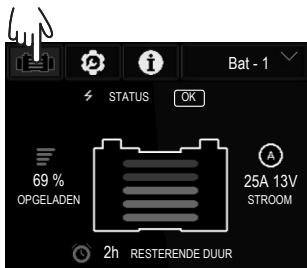

NOT_TOUCH_SB-01

BATTERIJ BANK



Scherm gegevens

State Of Charge / % opgeladen Bat - 1	60%
State Of Charge / % opgeladen Bat - 2	55%
Voltage	13,2V
Stroom	5A

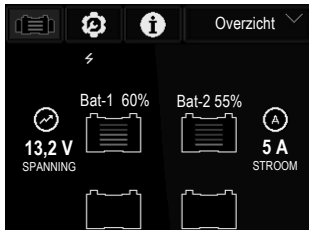

NOT_TOUCH_SB-01

TECHNISCHE SPEZIFIKATIONEN

<i>Versorgungsspannungsbereich</i>	8DC bis 35VDC
<i>Versorgungsstrom</i>	80mA (max) / 6mA (Schlafmodus)
<i>Frontdisplay</i>	2,4-inch TFT Farb-Screen mit 320x240 Pixel Auflösung
<i>Funktionen</i>	Spannung, Strom, SOC (Ladestatus), verbleibende Lade- & Entladezeit, einstellbare Helligkeit, automatischer Schlafmodus, 6 Sprachen (DE, EN, FR, IT, NL, SP)
<i>Betriebstemperatur</i>	-10°C bis +50°C
<i>Lagertemperatur</i>	-20°C bis +70°C
<i>Relative Feuchtigkeit</i>	10% bis 70%
<i>Präsentation</i>	Unterputzmontage
<i>Abmessungen</i>	Front Ø 93mm / Körper Ø 72mm / Tiefe 27mm
<i>Befestigung</i>	4 Schrauben
<i>Gewicht</i>	110 g
<i>Schutzklasse</i>	IP20 - P65 nur für Front-Panel
<i>Netzwerk-Protokoll & Anschluss</i>	CANBus / RJ11
<i>Richtlinien</i>	EMV-Richtlinie 2004/108/EC und LVD 2006/95/EC

NOT_TOUCH_SB-01

MONTAGEANLEITUNG

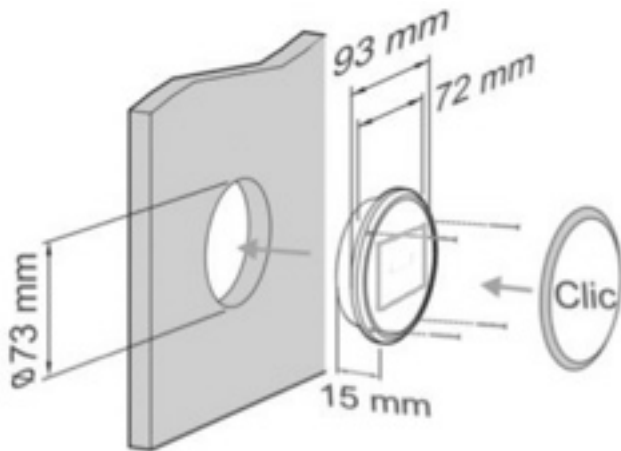

NOT_TOUCH_SB-01

AUTOMATISCHE IDENTIFIKATION

Bei einer Batterie mit einem ID010, schaltet der Touchscreen in einen automatischen Identifikationsmodus.



!!! Warnung: die Identifikation erfolgt Batterie pro Batterie. Die erste Batterie wird angeschlossen, die Identifikation erfolgt, dann die zweite, dann die dritte usw. ... Ein 120 Ohm Widerstand wird an die Kommunikations-Schnittstelle der Batterie während der Identifikation angeschlossen.

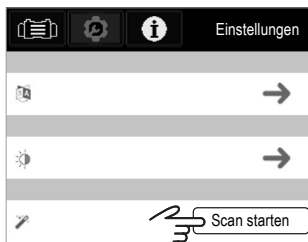

Wenn ein Problem während der Identifikation auftritt (oder wenn mehrere Batterien dieselbe ID haben), 10 bis 15 Sekunden **Ende** drücken und dann **Scan starten**. Nun kann wieder eine neue automatische Identifikation starten.

NOT_TOUCH_SB-01

EINSTELLUNGEN

Sprache

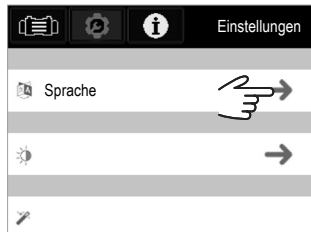

Helligkeit & Verzögerung vor "Schlafmodus" (10 Minuten im nachfolgenden Beispiel)

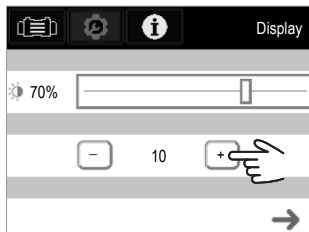

Hinweis: 2 Sekunden auf den Bildschirm drücken, um den "Schlafmodus" zu verlassen

NOT_TOUCH_SB-01

Netzwerk-Scan (falls es Probleme mit der Netzwerk-Kommunikation gibt)

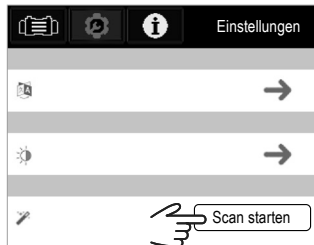

EINZELBATTERIE

Bildschirm-Daten

ZUSTAND (Batterie)	OK
Ladestatus	69%
Ladung / Entladung	LADUNG
Strom & Spannung (alternativ)	25A 13V
Verbleibende Lade-oder Entladezeit	2h

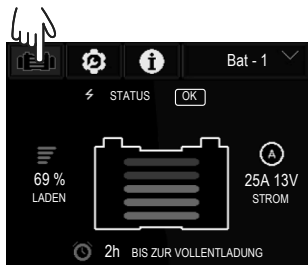

NOT_TOUCH_SB-01

BATTERIEBANK



Bildschirm-Daten

Ladestatus Bat - 1	60%
Ladestatus Bat - 2	55%
Spannung	13,2V
Strom	5A

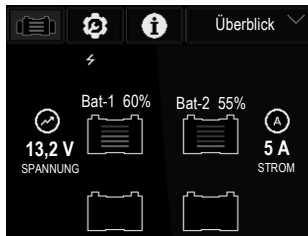

NOT_TOUCH_SB-01

SPECIFICHE TECNICHE

<i>Tensione di alimentazione</i>	da 8DC a 35VDC
<i>Corrente di alimentazione</i>	80mA (max) / 6mA (modalità SLEEP)
<i>Display frontale</i>	schermo a colori 2,4-pollici TFT con risoluzione 320x240 pixel
<i>Funzionalità</i>	Tensione, corrente, SOC (Stato di Carica), tempo restante di carica e scaricamento, luminosità regolabile, modalità SLEEP automatica, 6 lingue (DE, EN, FR, IT, NL, SP)
<i>Temperatura di funzionamento</i>	da -10°C a +50°C
<i>Temperatura di immagazzinaggio</i>	da -20°C a +70°C
<i>Umidità relativa</i>	da 10% a 70%
<i>Presentazione</i>	Dispositivo a incasso
<i>Dimensioni</i>	Davanti Ø 93mm / Corpo Ø 72mm / Profondità 27mm
<i>Fissaggio</i>	4 viti
<i>Peso</i>	110 g
<i>Classe di protezione</i>	IP20 - P65 per pannello frontale soltanto
<i>Protocollo di rete e connettore</i>	CANBus / RJ11
<i>Norme</i>	Direttiva CEM 2004/108/CE e Direttiva Bassa Tensione 2006/95/CE

NOT_TOUCH_SB-01

GUIDA PER IL MONTAGGIO

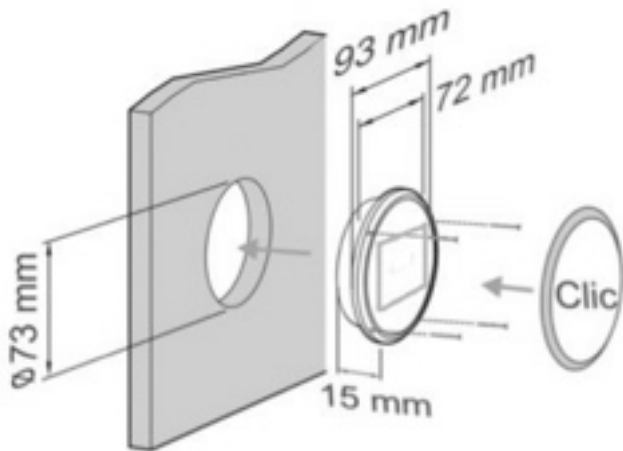

NOT_TOUCH_SB-01

IDENTIFICAZIONE AUTOMATICA

Nel caso di una batteria con un ID010, lo schermo tattile si mette in modo identificazione automatica.



!!! Attenzione, l'identificazione è eseguita una batteria dopo l'altra. La prima batteria è collegata, l'identificazione è eseguita, quindi la seconda, poi la terza e così via.... Durante l'identificazione, una resistenza di 120 Ohm è collegata nella porta di comunicazione della batteria.



Se si verifica un problema durante l'identificazione (o se più batterie hanno lo stesso ID), premere **Esci** e quindi **Avvio Scan** per 10 - 15 secondi. Può quindi ricominciare una nuova identificazione automatica.

NOT_TOUCH_SB-01

IMPOSTAZIONI

Lingua

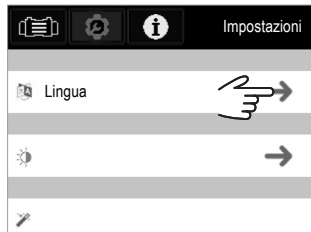

Luminosità e ritardo prima della "modalità SLEEP" (10 minuti nell'esempio qui sotto)

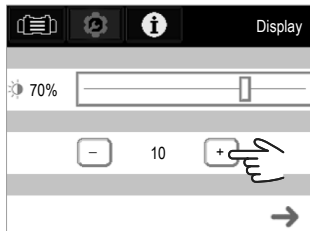
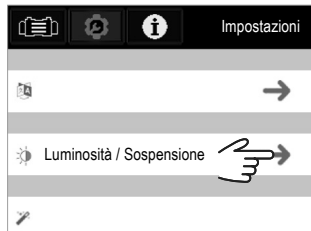

Nota: premere per 2 secondi sullo schermo per uscire dalla modalità "SLEEP"

NOT_TOUCH_SB-01

Scansione di rete (in caso di problemi con la comunicazione di rete)



BATTERIA SINGOLA

Dati della schermata

STATO (batteria)	OK
Stato di carica	69%
Carica / Scaricamento	CARICA
Corrente e Tensione (alternativamente)	25A 13V
Tempo restante prima della carica o dello scaricamento	2h



NOT_TOUCH_SB-01

BANCA DELLA BATTERIA

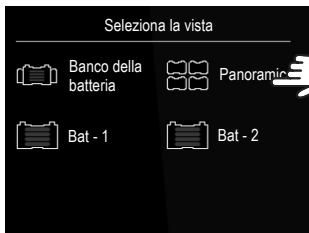

Dati della schermata

Stato di carica Bat - 1	60%
Stato di carica Bat - 2	55%
Tensione	13,2V
Corrente	5A

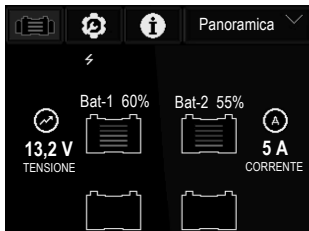

NOT_TOUCH_SB-01

ESPECIFICACIONES TÉCNICAS

<i>Rango de tensión de alimentación</i>	8 CC a 35 V CC
<i>Corriente de alimentación</i>	80 mA (máx.)/6 mA (modo de SUSPENSIÓN)
<i>Panel frontal</i>	Pantalla TFT en color de 2,4 pulgadas con resolución de 320x240 pixeles
<i>Prestaciones</i>	Tensión, corriente, estado de carga (SOC), carga y descarga, tiempo restante, brillo ajustable, modo de SUSPENSIÓN automático, 6 idiomas (DE, EN, FR, IT, NL, SP)
<i>Temperatura operativa</i>	-10 °C a +50 °C
<i>Temperatura de Imacenamiento</i>	-20 °C a +70 °C
<i>Humedad relativa</i>	10 % a 70 %
<i>Presentación</i>	Dispositivo de montaje empotrado
<i>Dimensiones</i>	Frente Ø 93 mm / Cuerpo Ø 72 mm / Profundidad 27 mm
<i>Fijación</i>	4 tornillos
<i>Peso</i>	110 g
<i>Clase de protección</i>	IP20 - P65 solo para el panel frontal
<i>Protocolo de red y conector</i>	CANBus / RJ11
<i>Normas</i>	Directiva CEM 2004/108/CE y DBT 2006/95/CE

NOT_TOUCH_SB-01

GUÍA DE MONTAJE

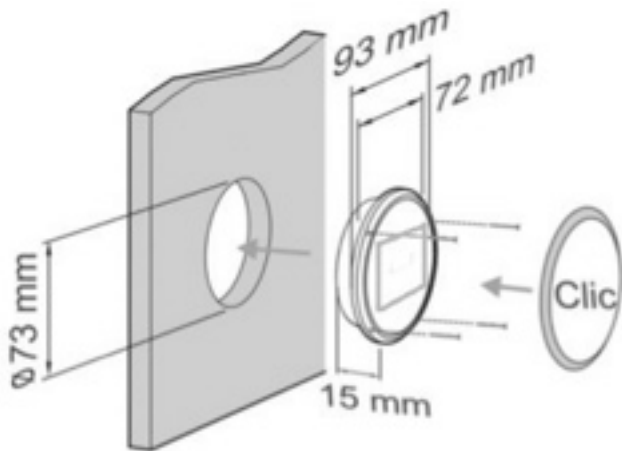

NOT_TOUCH_SB-01

IDENTIFICACIÓN AUTOMÁTICA

En caso de una batería con una ID010, la pantalla táctil entrará en modo de identificación automática.



¡¡ Advertencia: la identificación se realiza batería a batería. La primera batería está conectada, la identificación está hecha, proceda con la segunda, tercera, etc. Durante la identificación, se enchufa una resistencia de 120 Ohms en el puerto de comunicación de la batería.

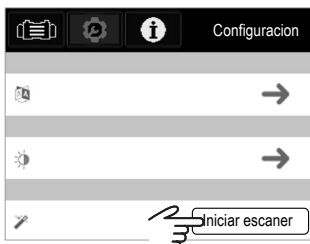

Si hubiera cualquier problema durante la identificación (o si varias baterías tienen la misma ID), pulse **Salir** y a continuación **Iniciar escáner** durante 10 o 15 segundos. Se puede iniciar una nueva identificación automática.

NOT_TOUCH_SB-01

AJUSTES

Idioma

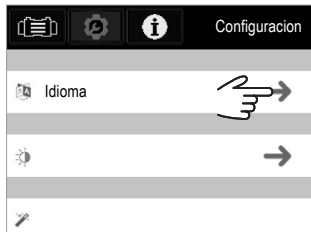

Brillo y retardo antes de «modo de SUSPENSIÓN» (10 minutos en el ejemplo a continuación)

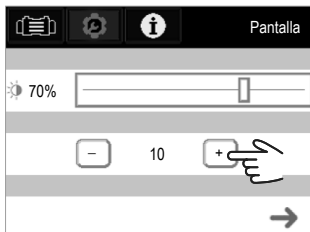
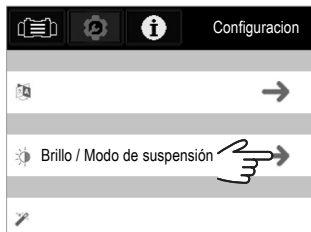

Nota: Pulse durante 2 segundos en la pantalla para salir del «modo de SUSPENSIÓN»

NOT_TOUCH_SB-01

Escáner de red (en caso de problema con la comunicación de la red)



BATERÍA ÚNICA

Datos de pantalla

Estado (batería)	OK
Estado de carga	69%
Carga / Descarga	CARGA
Corriente y tensión (alternativamente)	25A 13V
Tiempo restante antes de carga o descarga	2h



NOT_TOUCH_SB-01

BANCO DE BATERÍAS



Datos de pantalla

Estado de carga Bat - 1	60%
Estado de carga Bat - 2	55%
Tensión	13,2V
Corriente	5A

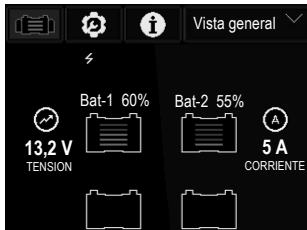

NOT_TOUCH_SB-01

SPECIFICATIONS TECHNIQUES

<i>Plage de tension d'alimentation</i>	8DC à 35VDC
<i>Courant d'alimentation</i>	80mA (maxi) / 6mA (mode VEILLE)
<i>Ecran façade</i>	Écran couleur 2,4-inch TFT avec résolution pixel 320x240
<i>Fonctionnalités</i>	Tension, courant, SOC (état de charge), temps restant charge & décharge, luminosité ajustable, mode VEILLE automatique, 6 langues (DE, EN, FR, IT, NL, SP)
<i>Température de service</i>	-10°C à +50°C
<i>Température de stockage</i>	-20°C à +70°C
<i>Humidité rel. de l'air</i>	10% à 70%
<i>Présentation</i>	Installation encastrée
<i>Dimensions</i>	façade Ø 93mm / bâti Ø 72mm / profondeur 27mm
<i>Fixation</i>	4 vis
<i>Poids</i>	110 gram
<i>Classe de protection</i>	IP20 - P65 pour panneau avant uniquement
<i>Protocole réseau & connecteur</i>	CANBus / RJ11
<i>Normes</i>	Directive CEM 2004/108/CE et LVD 2006/95/CE

NOT_TOUCH_SB-01

GUIDE DE MONTAGE

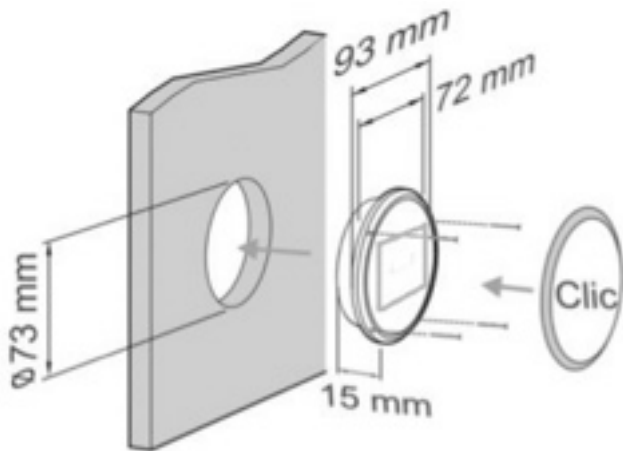

NOT_TOUCH_SB-01

IDENTIFICATION AUTOMATIQUE

Si une batterie possède l'ID010, le Touch effectue une identification automatique.

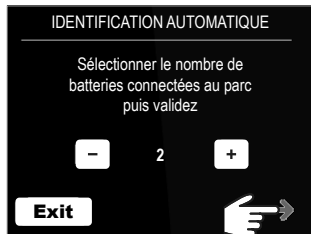

!!! Attention, l'identification est effectuée batterie après batterie. La première batterie est connectée, l'identification effectuée, puis la deuxième, puis la troisième, etc... Une résistance de 120 Ohms est connectée sur le port de communication de la batterie pendant l'identification.

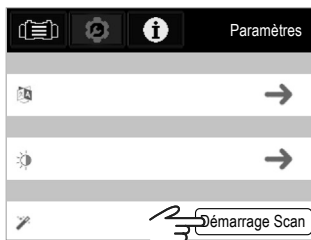

Si un problème survient durant l'identification (ou si plusieurs batteries ont le même ID), appuyer **Exit** puis **Démarrage Scan** pendant 10 à 15 secondes. Une nouvelle identification automatique démarre.

NOT_TOUCH_SB-01

PARAMETRES

Langue

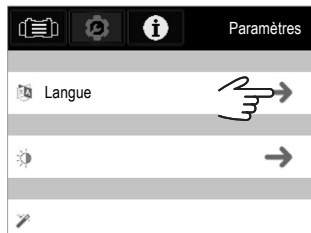

Luminosité et attente avant « mode VEILLE » (10 minutes dans l'exemple ci-dessous)

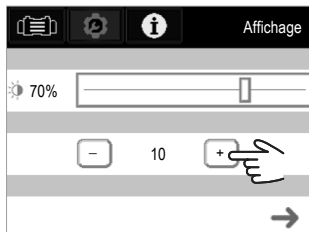
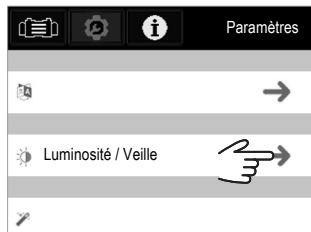

NB : appuyez durant 2 s sur l'écran pour quitter le « mode VEILLE »

NOT_TOUCH_SB-01

Scan réseau (en cas de problème avec la communication réseau)

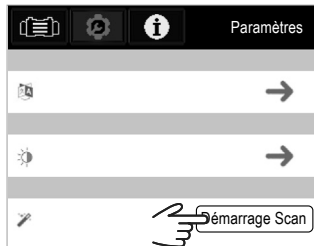

UNE SEULE BATTERIE

Infos écran

STATUT (batterie)	OK
État de charge	69%
Charge / Décharge	CHARGE
Courant & tension (en alternance)	25A 13V
Temps restant avant charge ou décharge	2h

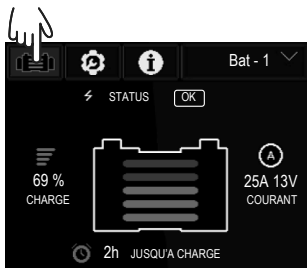

NOT_TOUCH_SB-01

PLUSIEURS BATTERIES



Infos écran

État de charge Bat - 1	60%
État de charge Bat - 2	55%
Tension	13,2V
Courant	5A

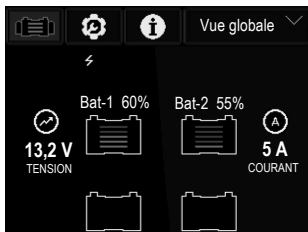

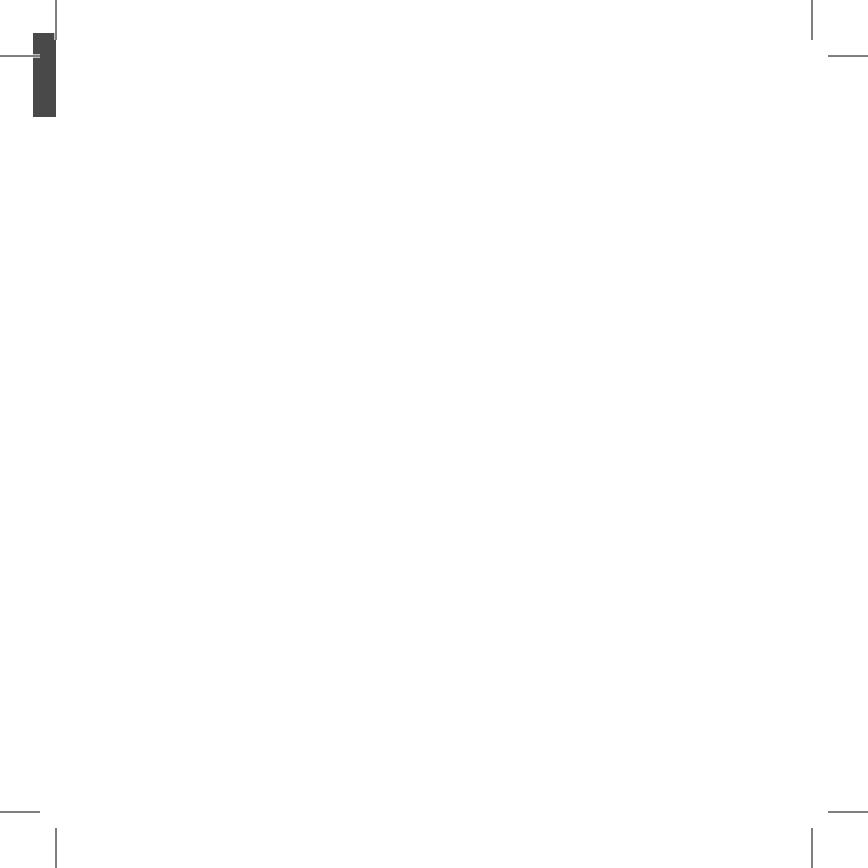



info@super-b.com
www.super-b.com