

MXG 1.2  
MXP  
MXS 1.2  
USER GUIDE 1.00



Made in Italy



1 – MX SERIES IN A FEW WORDS	04
2 – WHAT IS IN THE KIT?	06
3 – POWER	10
4 – WHAT YOU CAN DO VIA KEYBOARD	11
4.1 – SET DATE/TIME	13
4.2 – SET BACKLIGHT	13
4.3 – SET VIDEO INPUT	14
4.4 – COUNTERS MANAGEMENT	15
4.5 – GPS & TRACKS MANAGEMENT	16
4.6 – WI-FI MANAGEMENT	17
4.7 – SYSTEM INFORMATION	17
5 – WI-FI CONFIGURATION	18
5.1 – CONFIGURING MX SERIES LOGGERS AS AN ACCESS POINT (AP)	20
5.2 – ADDING MX SERIES LOGGERS TO AN EXISTING NETWORK	23
5.3 – WI-FI NETWORK SETTINGS	26
5.4 – THE INTERNET CONNECTIVITY	28
5.5 – CONNECTION ISSUES	28
5.6 – WORKING ON MAC™ WITH VIRTUALIZED WINDOWS™	29
5.7 – CONNECTED DEVICE VISUALIZATION ISSUES	32
6 – MX SERIES AND THE PC	33
6.1 – CONNECTION TO THE PC	33
6.2 – CONFIGURATION OF MX SERIES	33
6.2.1 – CHANNELS CONFIGURATION	35
6.2.2 – ECU CONNECTION AND CONFIGURATION	39
6.2.3 – RPM	41
6.2.4 – CAN2 STREAM CONFIGURATION	44
6.2.5 – CAN EXPANSIONS CONFIGURATION	45
6.2.6 – MATH CHANNELS CONFIGURATION	49
6.2.7 – STATUS VARIABLES CONFIGURATION	50
6.2.8 – PARAMETERS CONFIGURATION	52
6.2.9 – SHIFT LIGHTS AND ALARMS CONFIGURATION	54
6.2.10 – TRIGGER COMMANDS CONFIGURATION	59
6.2.11 – ICONS MANAGER CONFIGURATION	62
6.2.12 – DISPLAY CONFIGURATION	65
6.2.13 – SMARTYCAM STREAM SETTING	67
6.2.14 – CAN OUTPUT CONFIGURATION	68
6.3 – MANAGING A TRACK ON MX SERIES WITH RACE STUDIO 3	70
6.4 – ECU DRIVER BUILDER	74
6.5 – THE DEVICE WINDOW	76
6.5.1 – LIVE MEASURES LAYER	77
6.5.2 – ONLINE VALUE FORCING	77
7 – ON THE TRACK	79
8 – DATA RECALL	79
9 – DATA DOWNLOAD AND ANALYSIS	81
10 – NEW FIRMWARE UPGRADE	82
11 – CONNECTION WITH THE EXPANSIONS	83
11.1 – REAR CAMERAS CONNECTION AND MANAGEMENT	84
12 – TECHNICAL SPECIFICATIONS AND DRAWINGS	87

## MXG 1.2 - MXP - MXS 1.2



## 1. MX Series in a few words

### What is MX Series?

MX Series is the new AiM range of dashes that offers different dimensions, flexibility, usability and that may manage a wide range of channel inputs.

It features:

- ECU connection (CAN, RS232 and K-Line)
- 4 speed inputs
- 1 RPM input
- 8 analog inputs
- 2 analog video camera inputs
- up to 8 configurable display pages
- a huge tracks database to automatically select the track you are racing on
- from 5 to 8 alarm LEDs
- 10 RGB LEDs that you may configure for clearly showing if you are improving or not.

### What about ECU connection?

MX Series manages CAN, K-Line and RS232 ECU communication lines. Its huge database including more than 1500 ECU protocols is available.

### Is MX Series an expandable logger?

Yes. MX Series can be connected to various AiM expansions like GPS Module, Channel Expansion, TC Hub and LCU-One CAN to maximize your engine performances and to AiM SmartyCam to see your track performances on your PC with all the values you need in overlay.

### Anything else?

You may connect up to two additional optional back cameras to the dedicated input in order to show a reverse mirror image directly on its display.

The table here below shows the difference among the loggers.

FEATURE	MXG 1.2	MXP	MXS 1.2
Display	7" TFT	6" TFT	5" TFT
Resolution	800*480 pixels		
Contrast	1000:1	600:1	
Brightness	700cd/m <sup>2</sup> - 1,100 Lumen		
Light Sensor	Yes		
Alarm Display Icons	Yes, freely configurable		
Alarm RGB LEDs	8 configurable	5 configurable	6 configurable
Shift Lights	10 configurable RGB LEDs		
CAN Connection	3		
ECU Connection	CAN, RS232 or K-Line to 1.000 + industry leading ECUs		
Expansion Modules	GPS Module, Channel Expansion, TC Hub, Lambda Controller, SmartyCamHD		
Analog Inputs	8 fully configurable, max 1.000 Hz each		
Digital Inputs	4 speed inputs, lap signal, coil RPM input		
Digital outputs	2 (1A each)		
Second CAN	Yes		
WiFi connection	Yes		
Inertial platform	Internal 3 axis gyro, magnetometer and ±5G accelerometer		
Internal Memory	4GB		
Body	Anodized Aluminium		
Pushbuttons	Metallic		
Connectors	2 Motorsport connectors+1 Binder connector		
Dimensions	237*127.6*26 mm	189.6*106.4*24.9	169.4*97*23 mm
Weight	950g	640g	530g
Power Consumption	400mA		
Waterproof	IP65		



## 2. What is in the kit?

MX Series kit includes:

- MX Series logger
- 37 pins Deutsch connector harness with mini USB cable
- USB adapter cable (from mini to standard USB)
- GPS08 Module
- CD for software installation
- MX Series user manual



MX Series

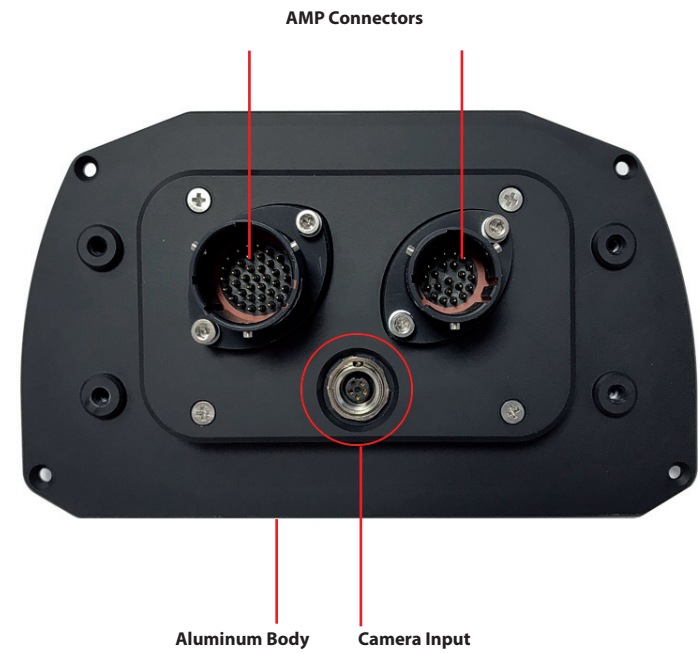
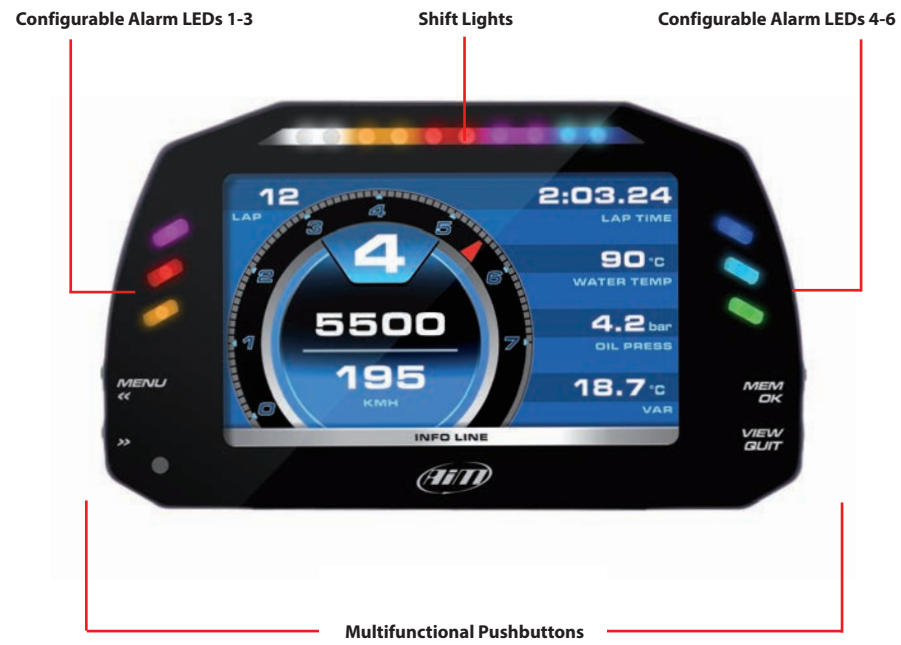

### 3 Power

The power is managed by two pins of the 37 pins connector:

- Pin 1: Power (9-15 Volts)
- Pin 2: Ground

They must be connected as shown in the following diagram.

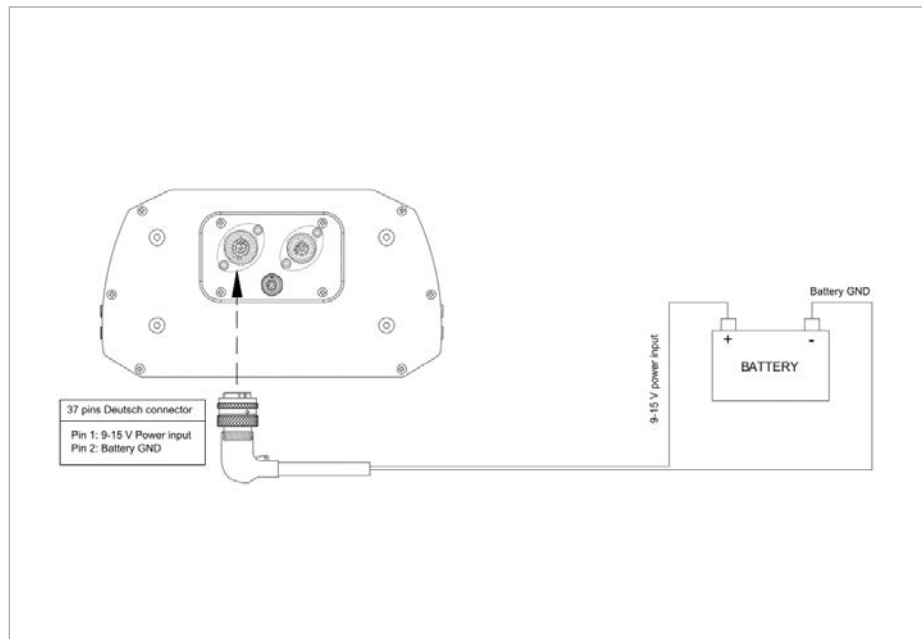

### 4 What you can do via keyboard

MX Series needs to be configured via software but there are some functions you can manage via the device lateral buttons,

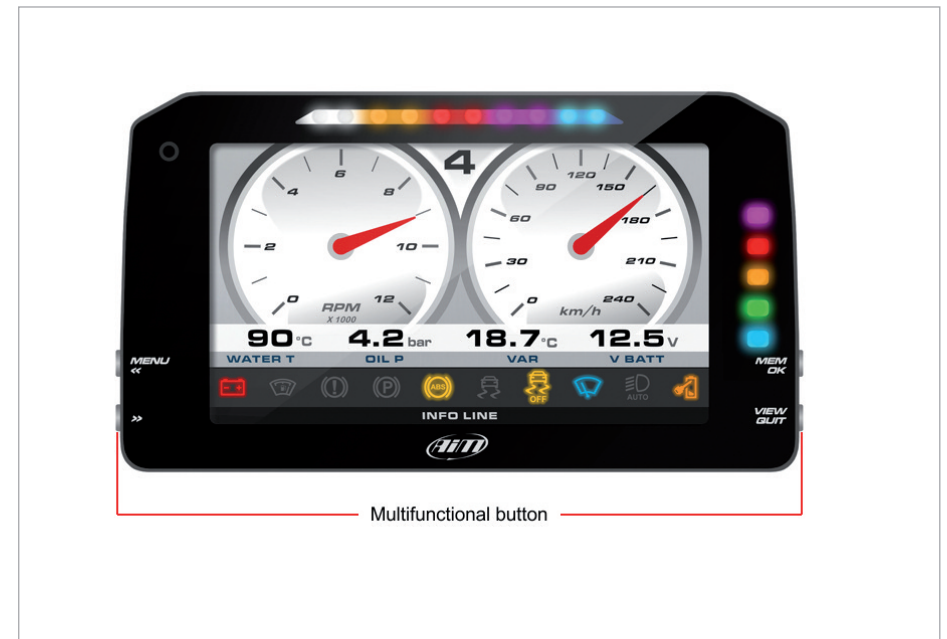

Press "Menu button and this page appears.



The icons are to manage:

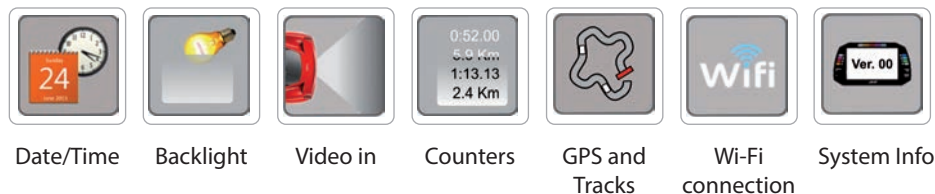

## 4.1 Set Date/Time



Here you can:

- set time zone
- enable/disable Daylight saving time
- set time and date format

Bottom of the page current time and date are shown.

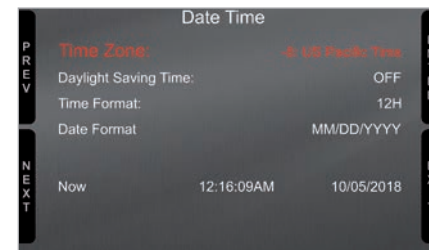

## 4.2 Set backlight



The brightness of the display and LEDs may be adjusted in two ways, depending on the light captured by a dedicated sensor integrated in the dash

- **AUTOMATIC:**  
in case ambient light is higher than a defined threshold, the brightness is reduced; you can set day and night brightness level as well as the brightness threshold value that switches from day to night mode



- **MANUAL:**  
you may define the brightness of the display and LEDs choosing among some values: 20%, 40%, 60%, 80%, 100%

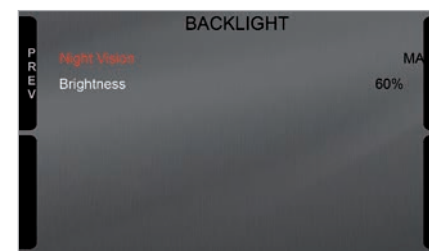



### 4.3 Set video input



Video In page manages up to two additional optional back cameras (that cannot be logged).

They are to be connected to the Binder 712 female connector rear central of MX Series logger, as shown in the pinout you find at the end of this user guide.

Features to set are:

- Input: Video 1 / Video 2
  - Format: NTSC/PAL
  - Brightness and Contrast from 10 to 100%
- Use "CHANGE" button to set each feature and "NEXT" to scroll the features.

Please refer to paragraph 11.1 ("Rear cameras connection and management") for further information.

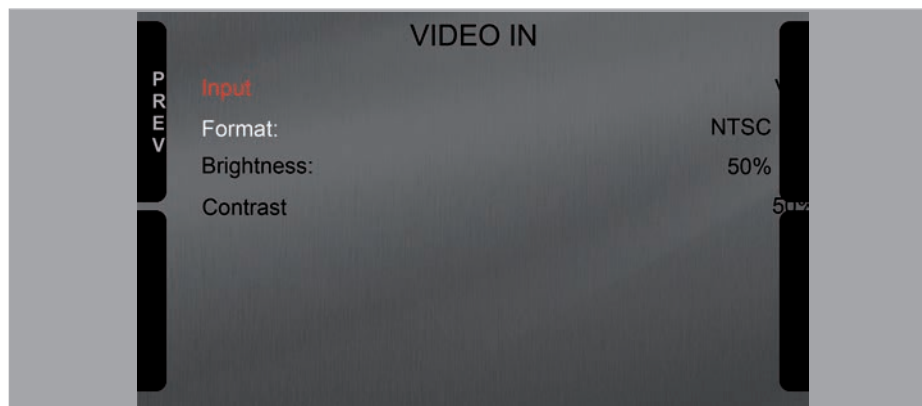

### 4.4 Counters management



MX Series features 4 user odometers, labelled User 1 – User 4, plus a non-resettable System Odometer. All odometers are shown on the configuration software Race Studio 3 too (see chapter about MX Series and the PC).

Each odometer can be activated/deactivated and/or reset. To manage an odometer select it and press "CHANGE".

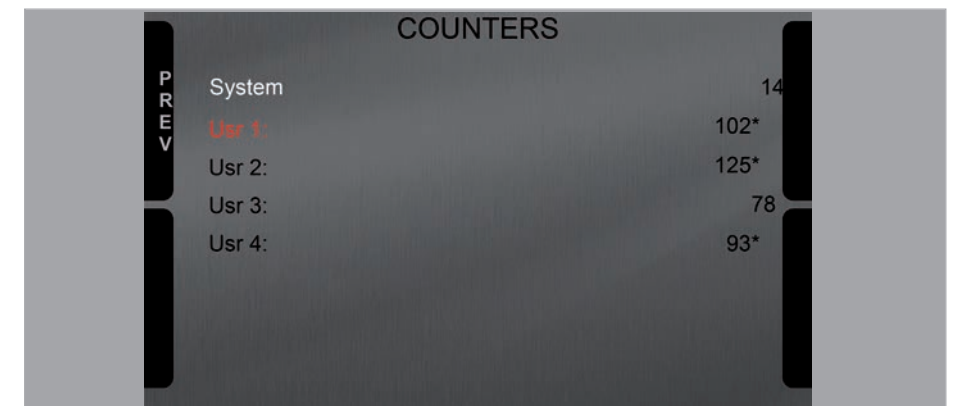



## 4.5 GPS & Tracks management



MX Series can be used on track thanks to AiM GPS08 Module included in the kit. This is used for:

- Lap time calculation
- Speed calculation
- Predictive lap time calculation

To calculate these data the system needs to know the start/finish line coordinates of the race-track you are racing on; MX Series comes with a long list of the world main tracks, constantly updated by our technicians and automatically loaded to your PC when you run Race Studio 3 software and a connection to the Internet is available.

MX Series provides two track selection modes: automatic and manual.

### Automatic:

MX Series automatically recognizes the track you are running on, loads the start/finish line and the possible splits coordinates and calculates lap and split times without optical/magnetic receiver. This is the best mode in most cases.

### Manual:

Allows to manually select the track from the internal database.

This mode is to be preferred when multiple track configurations are available nearby. In this case MX Series would anyway recognize the track but would need at least one complete track lap. You can scroll the list of available tracks choosing among these options:

- nearest: shows only tracks in a 10 km distance
- all: shows all tracks stored in the system in alphabetical order
- custom: shows only the tracks you have previously created (learning mode)

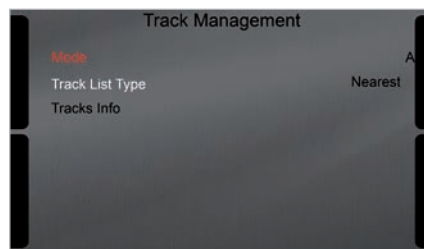

## 4.6 Wi-Fi Management



Here you can manage Wi-Fi as well as select the channel to be used (expert users only) and reset its configuration.

**Wi-Fi modes** are:

- ON
  - Auto: switches Wi-Fi on when the vehicle is stopped and automatically switches it off when MX Series starts recording according to the setting you performed in "Parameters" page of Race Studio 3 software (see paragraph 6.2.8 for further information)
- OFF

**Select Channel function is for expert users only;** here it is possible to select which Wi-Fi channel to use; available option are:

- AUTO (default – recommended)
- 1
- 6
- 11

"Wi-Fi reset CFG" resets Wi-Fi configuration and is very useful if you do not remember Wi-Fi password.

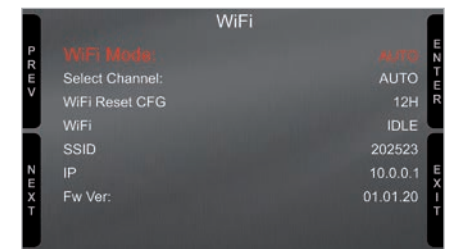

## 4.7 System Information

This page shows serial number as well as firmware and booter version of MX Series logger.

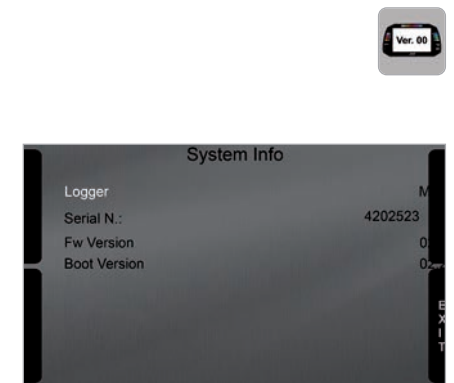

## 5 Wi-Fi configuration

Two possible Wi-Fi connection modes are available.

### 1 – As an access point (AP – default)

This is the ideal configuration for one only device and one only computer. In this situation MX Series creates a Wi-Fi network and works as an Access Point the PC can be connected to.



### 2 – Existing network (to connect to an existing Wi-Fi network – WLAN)

This mode is complex and implies an external access point (AP) but it is also more flexible and powerful because allows the communication among more than one device and more than one computer in the same network. MX Series and the PC must connect to an existing Wi-Fi network made by a device that works as an external access point.

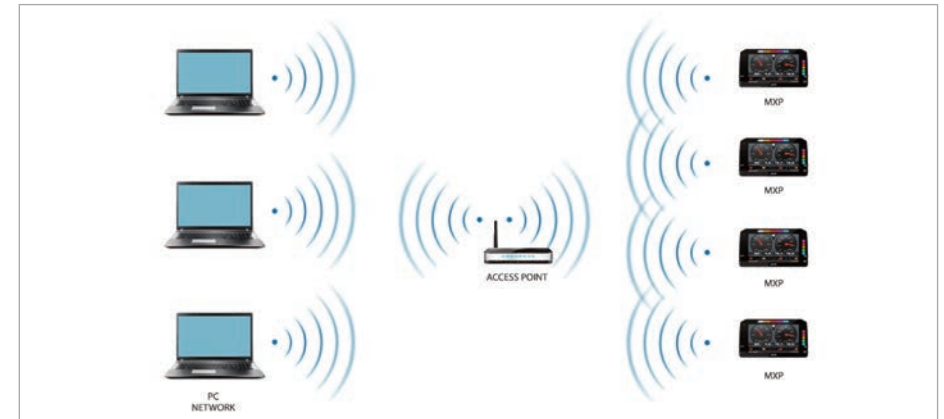

When working in WLAN mode MX Series has two available security levels:

- network authentication: network password
- device authentication: MX Series password

Both levels allow you the use of different strategies. A PC in WLAN, for example, can see several AiM devices but can communicate only with those he knows the password of.

Forgetting the password Wi-Fi configuration can be reset from MX Series menu as explained before.

## 5.1 Configuring MX Series loggers as an access point (AP)

This is MX Series default configuration and is the easiest and most direct connection mode, ideal to communicate with one MX Series logger using one PC. It is free and so completely accessible by anyone. Please set an access password as soon as possible.

To establish a Wi-Fi connection:

- ensure that the Wi-Fi is enabled
- read MX Series Name (4202523 in the image below)

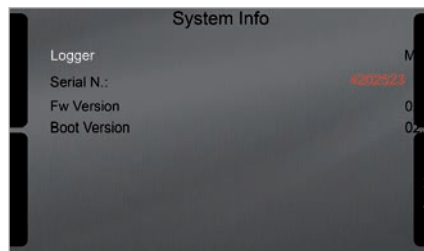

- run Race Studio 3
- click Wi-Fi icon and select your device
- in a few seconds the connection is established

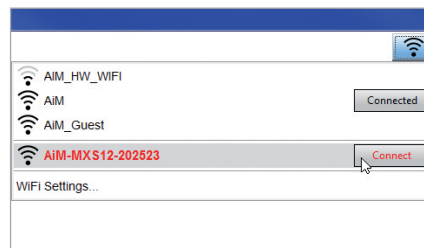

To set other parameters create a unique password to protect the device/ network. With a password the communication is safe and encrypted using WPA2-PSK standard.

Characters allowed in the password are all letters, also capital, all digits and these characters: '+- \_()[]{}\$£!/?^#@\*\\"=~/:/%"

“Space” type can be used if it is not the first one because this could cause incomprehension in some Windows™ versions.

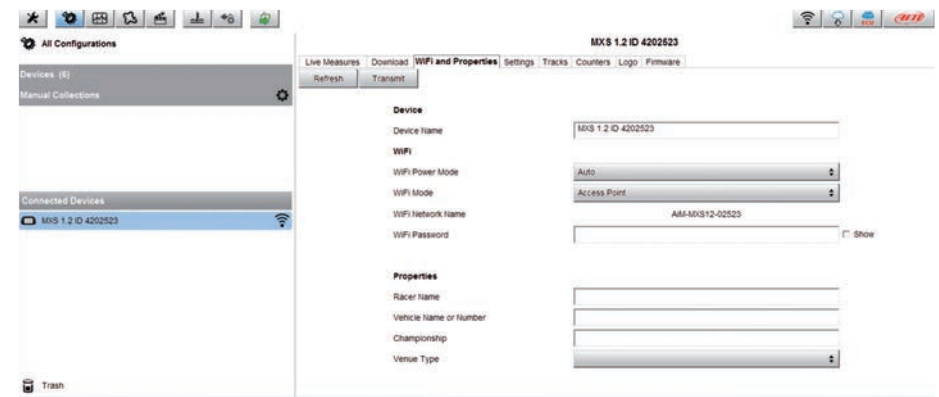

This AP or SSID name is unique for the device.

An example of name is: "AiM-MXS12-02523" where:

- "AiM" is the prefix of all AiM devices
- "MXS1.2" is the device identifier
- "02523" is device serial number assigned by the factory.

To make a device more recognizable a name can be added to the SSID. With the limit of eight characters. Allowed characters are all letters, capital too, all digits and these characters: '+ - \_ () [] {}!.

"Space" type can be used provided that it is not the first one because it can cause incomprehension in some WindowsTM versions.

Adding, for example, the driver's name, Tom Wolf, the network name (SSID) becomes:

"AiM-MX12-02523-TomWolf"

Once all parameters set click "Transmit". MX Series logger reboots and is configured with the new parameters. If MX Series logger is protected by a password, as recommended, Race Studio 3 will ask that password to authenticate.

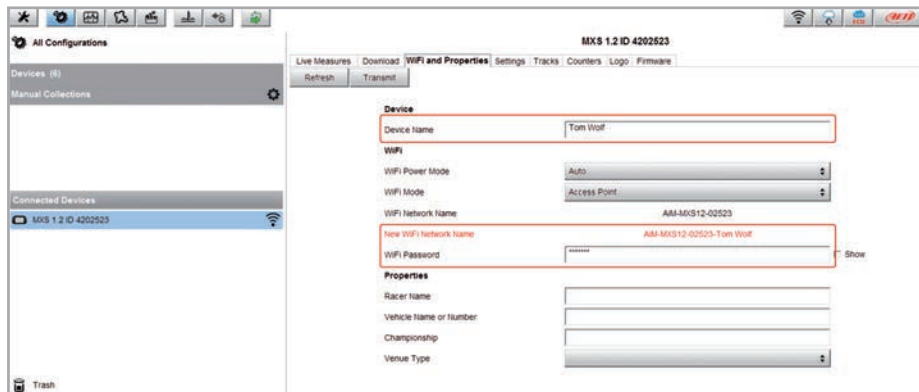

**Please Note:** the same Wi-Fi connection can be created with the operative system tool. Once the device has been authenticated in the Wi-Fi network it can communicate using Race Studio 3.

## 5.2 Adding MX Series loggers to an existing network

This situation is ideal for a team with multiple drivers and staff members and is desired to communicate with one or more AiM devices using the same PC network. Each MX Series logger can have its password that adds another security and privacy level to the network. Race Studio 3 will show all MX Series loggers connected to the same network under "Connected devices" label, bottom left of the software page: click the device.

Enter "Wi-Fi and properties" tab and set it on "Existing Network"; fill in network name, network password and device password.

Transmit the network settings to the device clicking "Transmit": it reboots and joins that network.

**Please note:** the only admitted password are those following WPA2-PSK standard.

To complete this procedure use Race Studio 3 software as here explained.

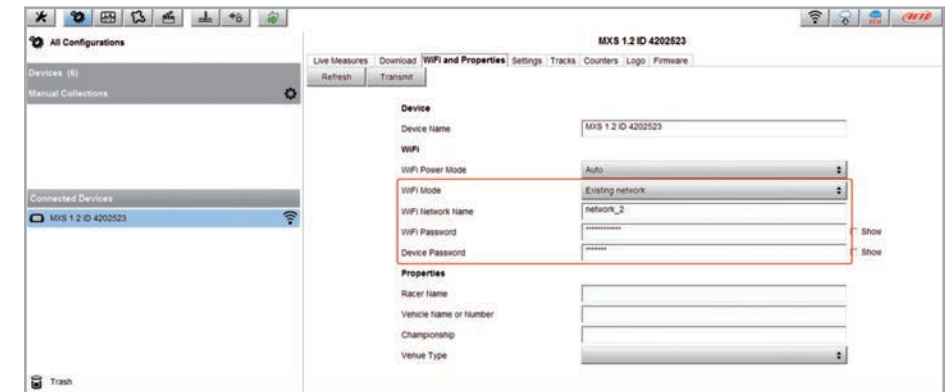

Here above is shown a device "MXS 1.2 ID 4202523" that switched from AP to WLAN mode (Existing Network). Network name is "network\_2" and does not work with free access because is protected by a password



To obtain connectivity on the device the PC has to be authenticated to the same network as shown here below.

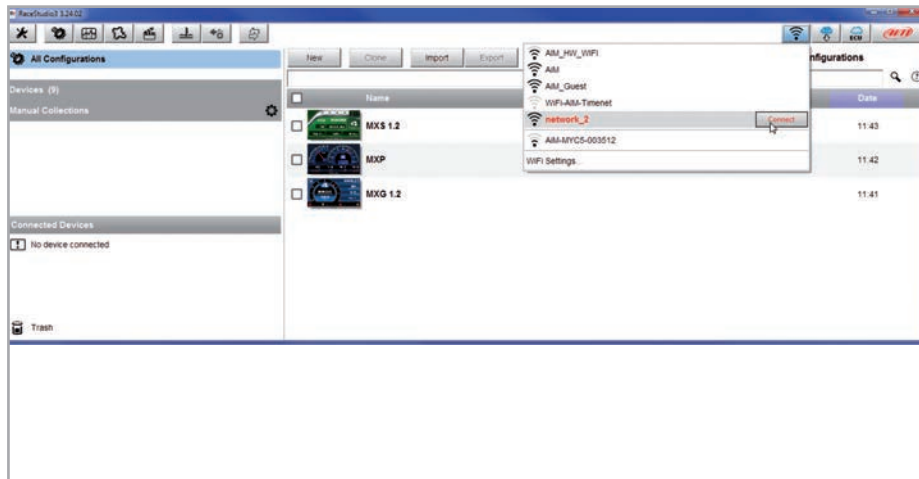

When the PC is authenticated to the network called “network\_2” it can see all devices you configured to access the same network. In the image below three AiM devices are connected to the same “network\_2” WLAN.

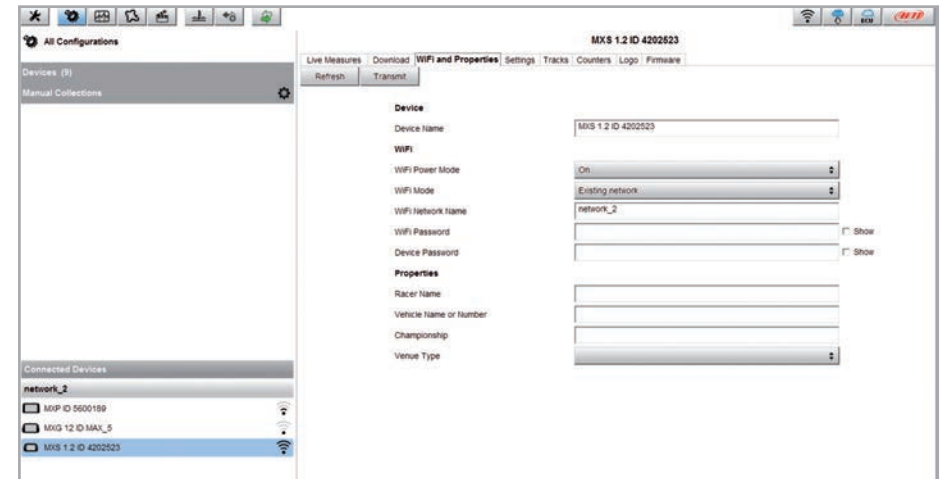

## 5.3 Wi-Fi network settings

In this chapter is a short description of how to configure a WLAN including AiM devices and a PC.

Here below is an example of configuration.

The screenshot shows the router's configuration interface. It is divided into two main sections: 'ROUTER SETTINGS' and 'DHCP SERVER SETTINGS'.  
**ROUTER SETTINGS:** This section includes fields for Router IP Address (192.168.0.1), Subnet Mask (255.255.255.0), Device Name (Network\_1), Local Domain Name, and an option to Enable DNS Relay (checked).  
**DHCP SERVER SETTINGS:** This section includes options to Enable DHCP Server (checked), DHCP IP Address Range (192.168.0.2 to 192.168.0.6), DHCP Lease Time (10080 minutes), Always Broadcast (checked), NetBIOS announcement, Learn NetBIOS from WAN, NetBIOS Scope, and NetBIOS mode type (Broadcast only selected). It also has fields for Primary and Secondary WINS IP Addresses.

For better network performances, we suggest the use of a network device equipped with a DHCP server and using 3x3 MIMO technology like, for example a Linksys AS3200.

To maximize the bandwidth the Internet should not be allowed on this WLAN; this means the DHCP server should be configured without any DNS address nor gateway by default.

The parameters for the device network configuration in this example are:

- **Wireless network name: Network\_1**  
It means that the WLAN network name is "Network\_1." A PC has to be authenticated in this network to interact with any AiM device of this network.
- **Gateway address: 192.168.0.1**  
primary DNS server: 0.0.0.0  
secondary DNS server: 0.0.0.0  
(These settings prevent Internet connectivity on this WLAN.)
- **Subnet mask: 255.255.255.248**  
Enable DHCP server: yes  
DHCP IP address range: 192.168.0.2 to 192.168.0.6

These settings enable a DHCP server running on this WLAN and provide an IP address in a 2-6 range. This means that this network allows 5 network hosts.

The number of devices on a WLAN network depends on the subnet mask. Here below are typical examples of network masks and IP addresses range.

The configuration in bold is the one we suggest (if a greater number of devices is not needed), being the one that makes it easier and quicker for Race Studio 3 the identification of the devices in the network.

Subnet mask:	IP address range:	Number of devices:
255.255.255.0	192.168.0.1 - 254	254
255.255.255.128	192.168.0.1 - 126	126
255.255.255.192	192.168.0.1 - 62	62
255.255.255.224	192.168.0.1 - 30	30
255.255.255.240	192.168.0.1 - 14	14
<b>255.255.255.248</b>	<b>192.168.0.1 - 6</b>	<b>6</b>

## 5.4 The Internet connectivity

For an optimal speed of AiM device(s) it is recommended not to allow the Internet on the same network and to set the WLAN in the same way.

The Internet access can of course be allowed on the network but this would degrade the communication.

This slightly slower speed can be suitable but a second Wi-Fi connection through an additional hardware (NIC) is to be preferred.

This configuration would provide an optimal speed of the data network of your AiM device(s) and at the same time would provide an internet connectivity with the second NIC.

## 5.5 Connection issues

It can occur that MX Series logger is correctly connected to Race Studio 3 via Wi-Fi but the user interface does not show it. This may be because Wi-Fi port setting is set with a static IP. To switch it to dynamic (DHCP):

- open "Network and sharing centre" in the Windows™ research engine
- right click on the Wi-Fi connection and a panel shows up
- select "Properties" option
- double click on "Internet Protocol version 4 (TCP/IPv4)"
- verify that option "Obtain an IP address" is active

For further information refer to FAQ section, Wi-Fi of [www.aim-sportline.com](http://www.aim-sportline.com).

## 5.6 Working on Mac™ with virtualized Windows™

Race Studio 3 only works on Windows™ operative systems; Mac users can use a virtualized Windows™ machine. The main problem is that the host OS (Mac) must share its Wi-Fi interface with the virtualized operative system (Windows) as Ethernet interface and not as Wi-Fi interface.

### Configuring Parallels™

Select "Menu → Configure..." in Parallels.

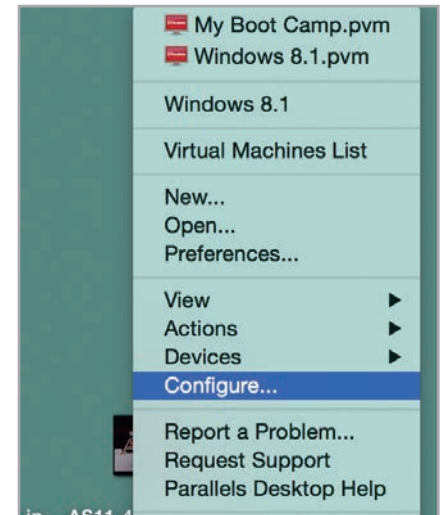

Press "Hardware" – top on the page that shows up – and select "Network" in the drop-down menu on the left.

Right on the configuration panel set "Type" field on "Wi-Fi".

Then select the device to communicate with.

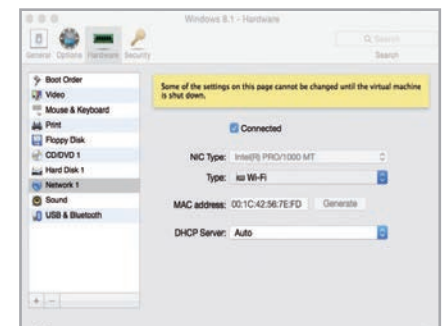

To ensure that the communication works select "Open Network preferences..." menu.

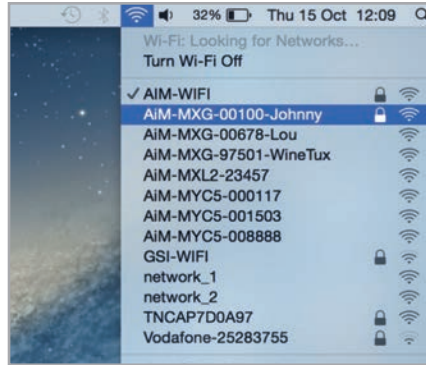

Verify that the status in the window that shows up is "Connected" and that the IP address associated is, for example, 10.0.0.10 (could be 10.0.0.11, 10.0.0.12, or generically 10.0.0.x).

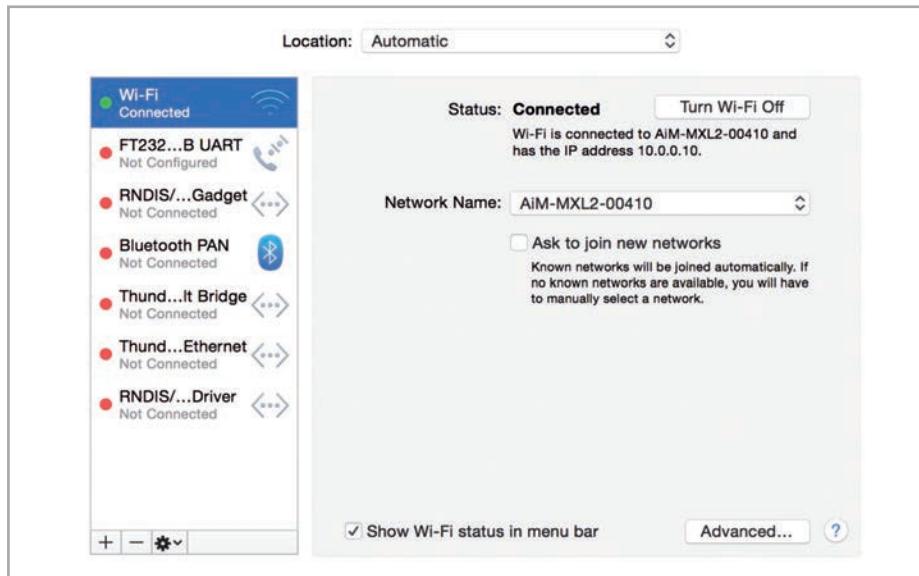

To enable Race Studio 3 correctly working on a Mac with virtualized Windows™.

- press Wi-Fi icon ( )
- select "Wi-Fi Settings" option

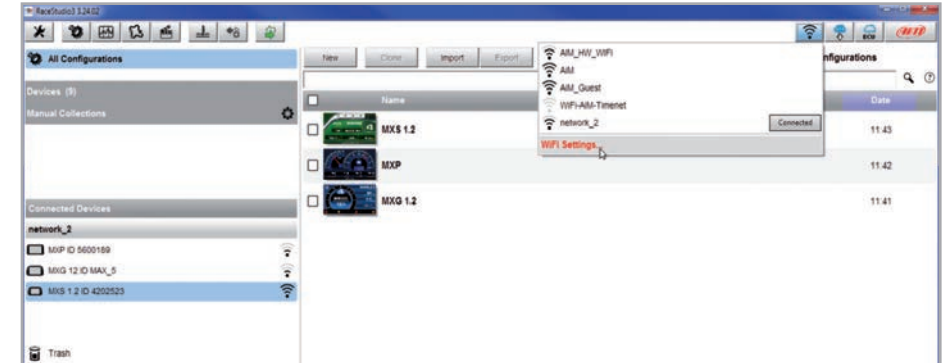

- enable the checkbox shown here below.

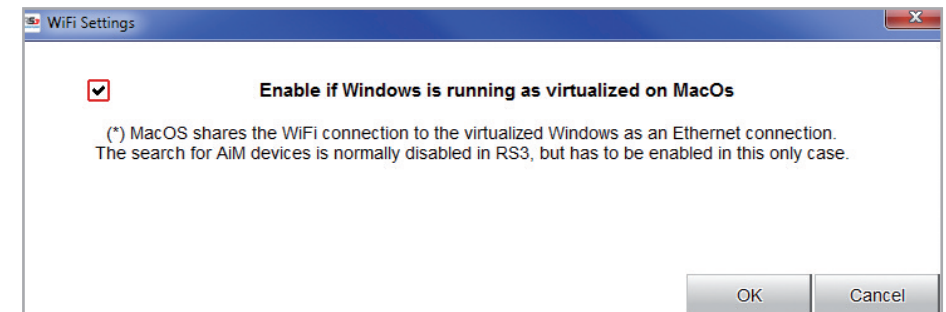



## 5.7 Connected device visualization issues

It may occur that using Race Studio 3 on an iMac with virtualized Windows the device connected via Wi-Fi takes some time to be shown in the network or is not shown at all. This is why we always suggest using an Wi-Fi (WLAN) router.

This router work as an Access Point allowing more external devices to connect to its network. MX Series logger Wi-Fi configuration is to be set on Existing Network as explained before.

## 6 MX Series and the PC

Using AiM Race Studio 3 software you can configure MX Series, manage its tracks database as well as check other device functions through Race Studio 3 device window.

### 6.1 Connection to the PC

MX Series can be connected to the PC via Wi-Fi or using the USB cable included in the kit: plug it in the cable labelled "USB" of MX Series 37 pins connector harness and in the PC USB port.

### 6.2 Configuration of MX Series

Once MX Series connected to the PC

- click "Configurations" icon  and configurations page appears
- click "New" and new configuration panel appears: select "MX Series" logger and press "OK"; when performing subsequent configurations "Select Configuration" panel shows on top the last four devices you configured.

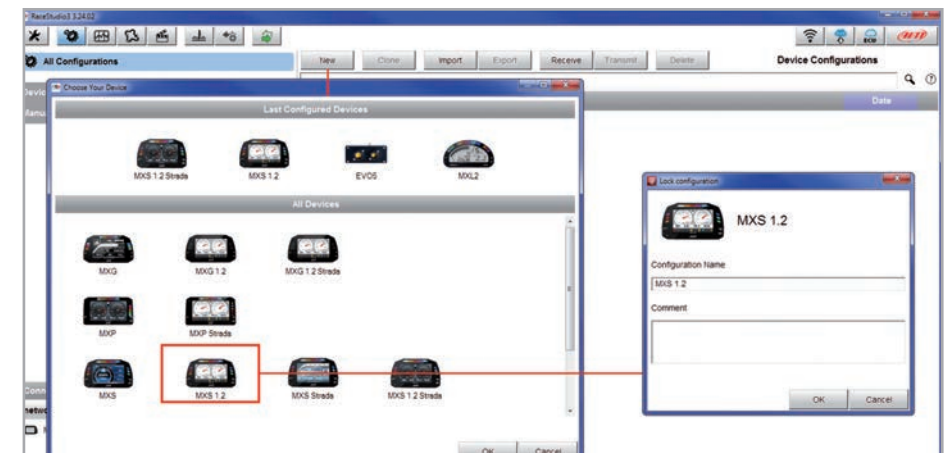

This is the list of the features to be configured:

- Channels: analog and digital sensors directly connected to MX Series loggers.
- ECU: the Engine Control Unit of your vehicle. MX Series logger manages CAN, RS232 and K-Line protocols
- CAN2: in case the system is connected to other CAN devices, beside the ECU, they have to be connected to CAN 2 port
- CAN expansions: other AiM CAN Devices, like, for example, Lambda controller, GPS Module, Channel expansions etc.
- Math channels: some calculated channels that may be helpful in some situations
- Some other calculated variables, useful for managing alarms, icons, LEDs.

## 6.2.1 Channels configuration

To set all the device channels.

RPM channel is by default enabled: since direct RPM connection is used when the vehicle does not have an ECU, the software automatically disables it when an ECU protocol is selected. See paragraph 6.2.3 for further information about the hardware RPM signal connection

ID	Name	Function	Sensor	Unit	Freq	Parameters
SPR	<input checked="" type="checkbox"/> RPM	Engine RPM	RPM Sensor	rpm	20 Hz	max: 16000; factor: 1;
SPe1	<input type="checkbox"/> Speed1	Vehicle Spd	Speed Sensor	kmh 0.1	20 Hz	wheel: 1600; pulses: 1;
SPe2	<input type="checkbox"/> Speed2	Vehicle Spd	Speed Sensor	kmh 0.1	20 Hz	wheel: 1600; pulses: 1;
SPe3	<input type="checkbox"/> Speed3	Vehicle Spd	Speed Sensor	kmh 0.1	20 Hz	wheel: 1600; pulses: 1;
SPe4	<input type="checkbox"/> Speed4	Vehicle Spd	Speed Sensor	kmh 0.1	20 Hz	wheel: 1600; pulses: 1;
ChA1	<input type="checkbox"/> Channel01	Voltage	Generic 0-5 V	mV	20 Hz	
ChA2	<input type="checkbox"/> Channel02	Voltage	Generic 0-5 V	mV	20 Hz	
ChA3	<input type="checkbox"/> Channel03	Voltage	Generic 0-5 V	mV	20 Hz	
ChA4	<input type="checkbox"/> Channel04	Voltage	Generic 0-5 V	mV	20 Hz	
ChA5	<input type="checkbox"/> Channel05	Voltage	Generic 0-5 V	mV	20 Hz	
ChA6	<input type="checkbox"/> Channel06	Voltage	Generic 0-5 V	mV	20 Hz	
ChA7	<input type="checkbox"/> Channel07	Voltage	Generic 0-5 V	mV	20 Hz	
ChA8	<input type="checkbox"/> Channel08	Voltage	Generic 0-5 V	mV	20 Hz	
Acc1	<input checked="" type="checkbox"/> InlineAcc	Inline Accel	AIM Internal Accelerometer	g 0.01	50 Hz	
Acc2	<input checked="" type="checkbox"/> LateralAcc	Lateral Accel	AIM Internal Accelerometer	g 0.01	50 Hz	
Acc3	<input checked="" type="checkbox"/> VerticalAcc	Vertical Accel	AIM Internal Accelerometer	g 0.01	50 Hz	
Gyr1	<input checked="" type="checkbox"/> RollRate	Roll Rate	AIM Internal Gyro	deg/s 0.1	50 Hz	
Gyr2	<input checked="" type="checkbox"/> PitchRate	Pitch Rate	AIM Internal Gyro	deg/s 0.1	50 Hz	
Gyr3	<input checked="" type="checkbox"/> YawRate	Yaw Rate	AIM Internal Gyro	deg/s 0.1	50 Hz	
AccG	<input checked="" type="checkbox"/> GPS Accuracy	GPS Accuracy	AIM GPS	m	10 Hz	

To set a channel just click on its line and the related panel shows up.

The first two channels in the list are RPM and Speed, than we have the configurable channels, that can be managed as analog or as digital according to what you connect them.

Typically, analog sensors are pressure sensors, thermocouples, potentiometers etc... while digital inputs are used for managing pushbuttons, that may eventually be used for activating the Digital outputs.

Selecting "Analogic" options to be set are

- Channel name
- Function: this parameter is useful in the data analysis process
- Sensor type
- Measure unit
- Sampling frequency
- Display precision: it configures how many decimal digits you will see in your dash
- Specific parameters

In the following image you see two different channels configuration windows.

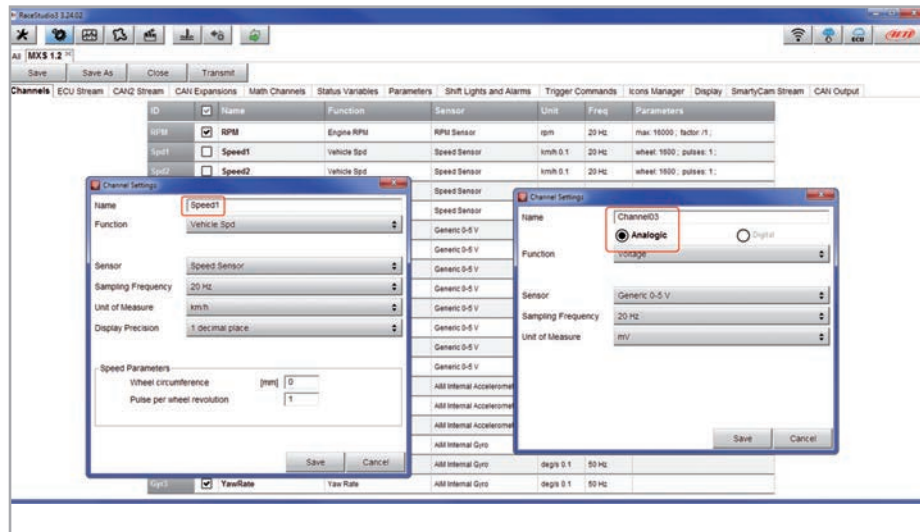

In case you need to use an input as **Digital Input** you have to configure its parameters as follows:

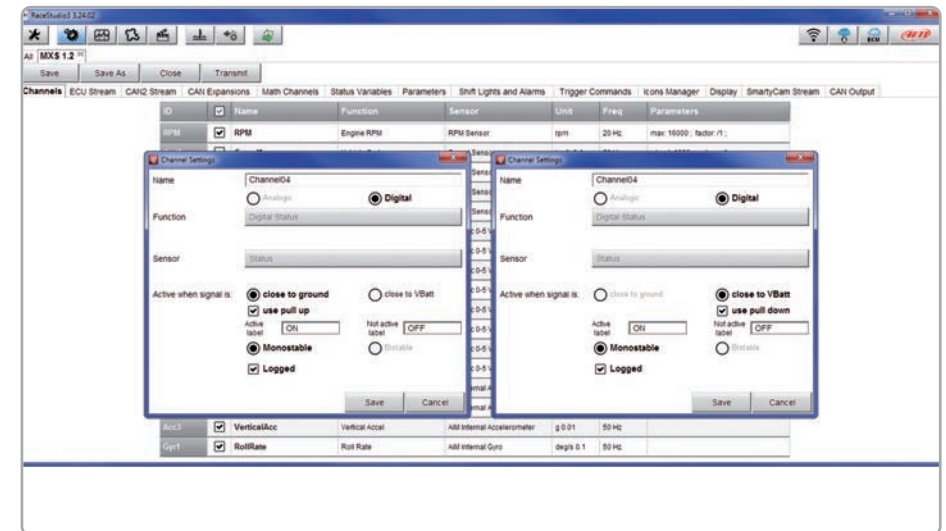

- Working mode: a Digital input can work in two different ways:
  - The pushbutton closes to ground (with or without pull up resistor – left image below)
  - The pushbutton closes to VBattery (with or without pull down resistor – right image below)

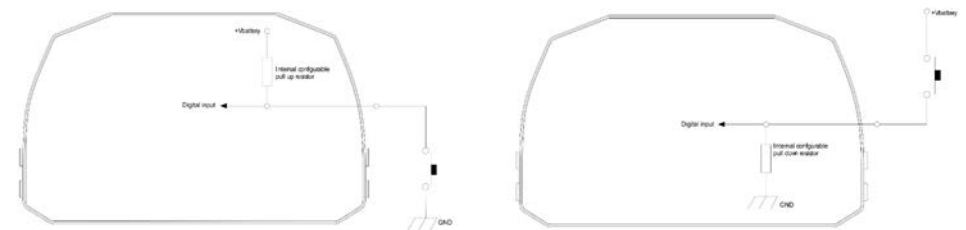

■ **Active/Not active labels:** according to the status, a Digital channel may assume the values: 0/1, High/Low, ON/OFF, Closed/Open, True/False, etc.

The two different labels can be defined and eventually shown on the display, used by Math channels, Icons Management, alarm managements and in general, any time a digital channel is required; the labels appears in Device page too.

■ **Signal type:** can be monostable or bistable, to say

■ **Monostable:** the channel is active when the pushbutton is closed

■ **Bistable:** the channel is activated the first time you close the circuit and deactivated the second time the circuit is closed as shown here below

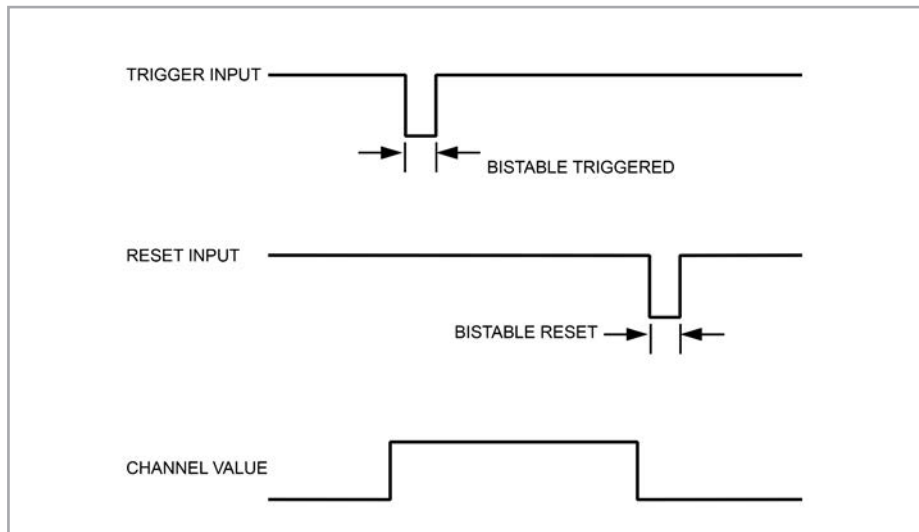

■ **Logged:** if active, the system records the digital values, else they can be used and shown but they are not recorded.

## 6.2.2 ECU Connection and configuration

MX Series can be connected to the vehicle ECU. Documents explaining how to connect MX Series to the vehicle ECU are published on our website [www.aim-sportline.com](http://www.aim-sportline.com) and a PDF file with protocols updates history can be loaded clicking on the question mark as shown here below. MX Series can communicate through CAN, RS232 and K-Line communication lines. The ECU protocol includes 1500 different protocols and is constantly updated by our technicians. In case of a CAN based ECU whose protocol is not in the database, the ECU Driver Builder function (paragraph 6.4) allows to develop it.

To load the ECU protocol in MX Series configuration:

- enter "ECU Stream" tab
- press "Change ECU" button
- select "ECU Manufacturer" and "ECU Model" (in the example FORD/ MUSTANG 2010)
- press OK

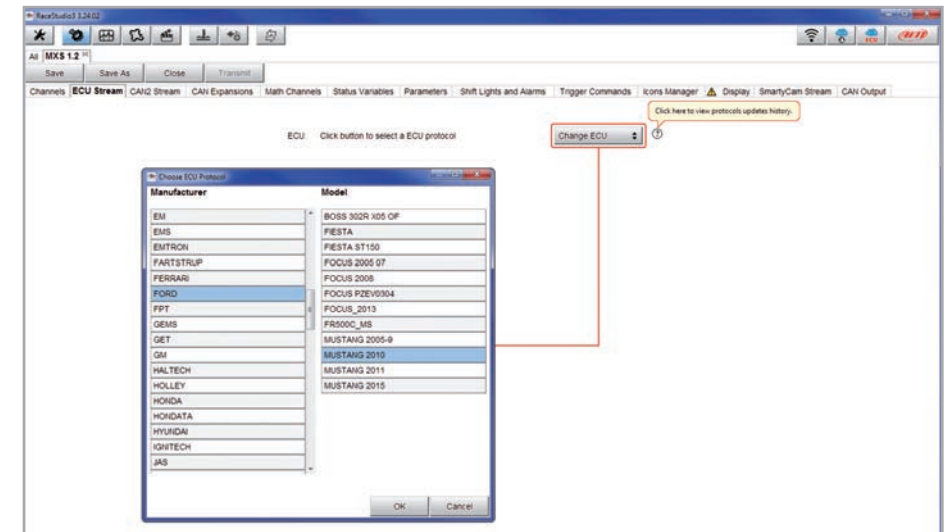



After setting the protocol the system comes back to “ECU Stream” page and two checkbox appears:

■ “Enable the CAN Bus 120 Ohm Resistor” (enabled by default; to be disabled in case MX Series logger is additional to the vehicle dash): the CAN Bus needs two 120 Ohm resistors at its two extremes. In case MX Series is the only device connected to the ECU the 120 Ohm resistor should be enabled, else, very easily, it is already present in the existing network and should be disabled;

■ “silent on CAN Bus” (disabled by default): usually the ECU expects an acknowledge signal when transmits a message and, as default, the MX Series transmits this signal. Sometimes, particularly when there are other devices in the network, MX Series should not transmit it; in this case, enabling this flag MX Series logger remains completely silent.



## 6.2.3 RPM

MX Series can receive RPM value from the ECU. If, on the contrary, the vehicle does not have an ECU RPM can be sampled using the wire labelled “RPM” (corresponding to pin 15) of MX Series 37 pins connector harness.

### RPM from ECU

To get the RPM from the ECU just connect MX Series logger to the ECU and it will automatically sample that value.

### RPM via a 5-50V square wave or coil (150-400V)

If the vehicle has no ECU connect wire labelled “RPM” (corresponding to pin 15) of the device 37 pins connector harness to the ignition system. This way MX Series can read the signal from the low voltage of the coil (whose peak can be from 150 to 400 V) or from a possible square wave (the peak can be from 5 to 50 V).

The image below shows an example of wiring of the ignition system.

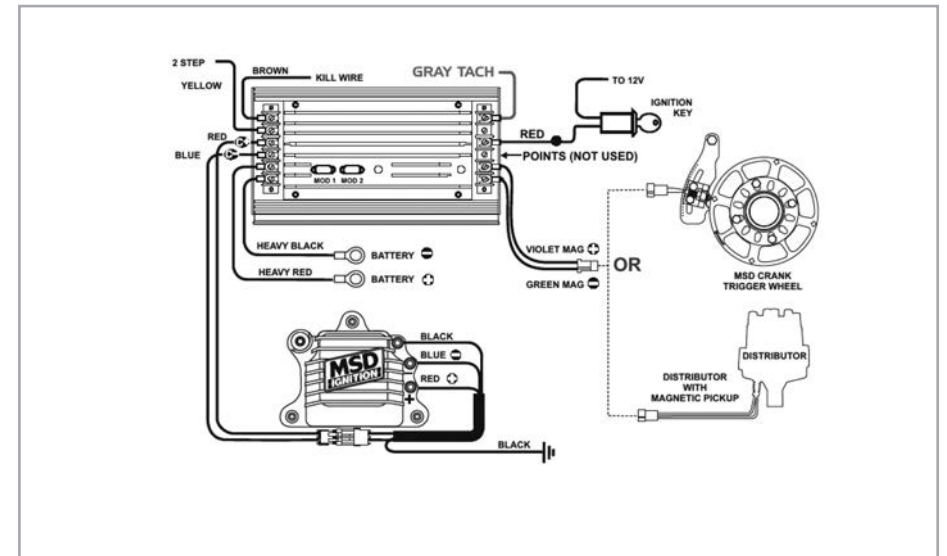

The output labelled “GRAY TACH” gives a 5-50V output that can be directly sampled by MX Series logger.

In case the vehicle ignition system has no output MX Series logger should be connected to the low voltage of the coil as shown in the following images.

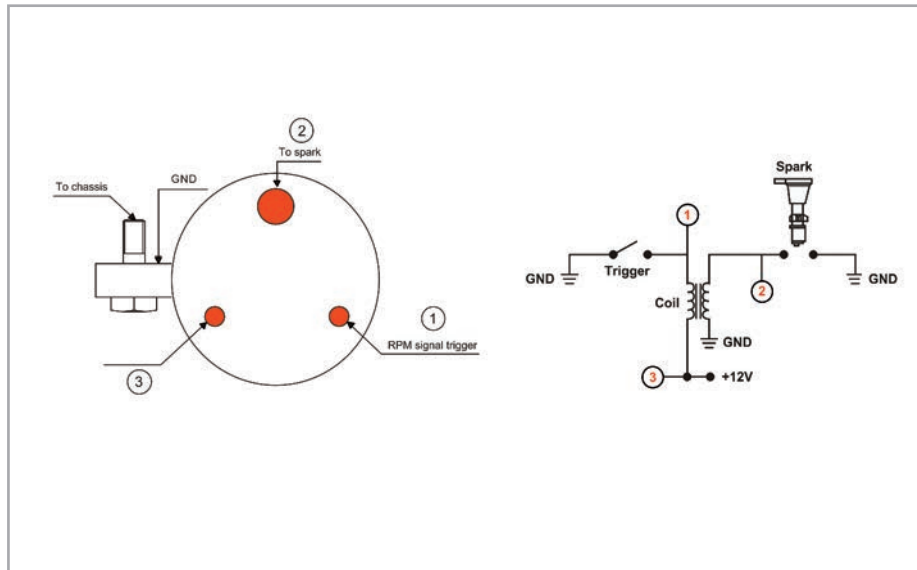

- Point 1: low voltage of the coil
- Point 2: connected to the spark plug
- Point 3: connected to the +12V of the battery

Once MX Series connected to RPM signal enable it and set its parameters in channels page of Race Studio 3 as explained in "Channels configuration" paragraph.

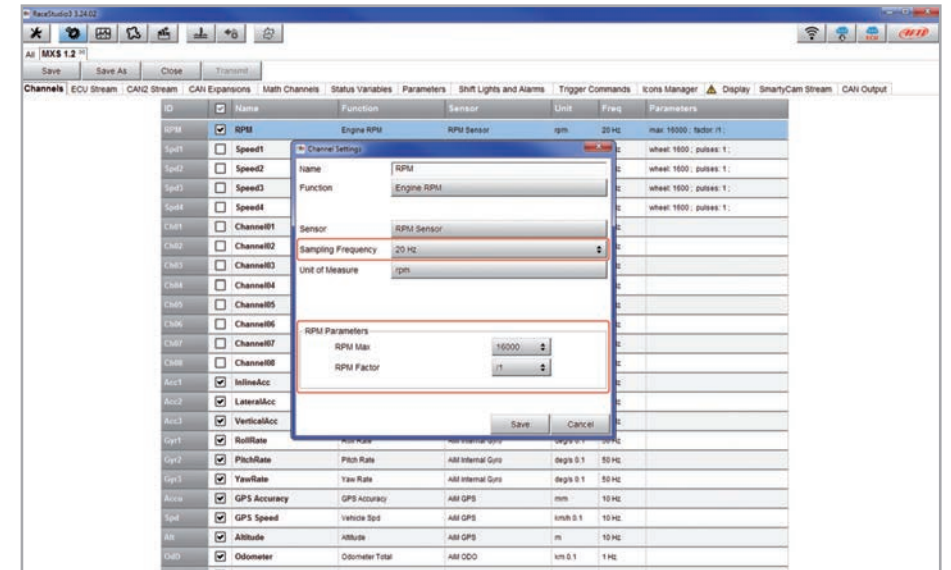

## 6.2.4 CAN2 Stream configuration

This page works exactly like ECU Stream one. Here you can find additional CAN modules. To load additional CAN protocol modules:

- enter "CAN2 Stream" tab
- press "Change protocol" button
- select "Manufacturer" and "Model" (in the example MEGALINE/PADDLESHIFT)
- press OK

As for ECU Stream a PDF file with protocols updates history can be loaded clicking on the question mark as shown here below and the two checkboxes appears as explained before.

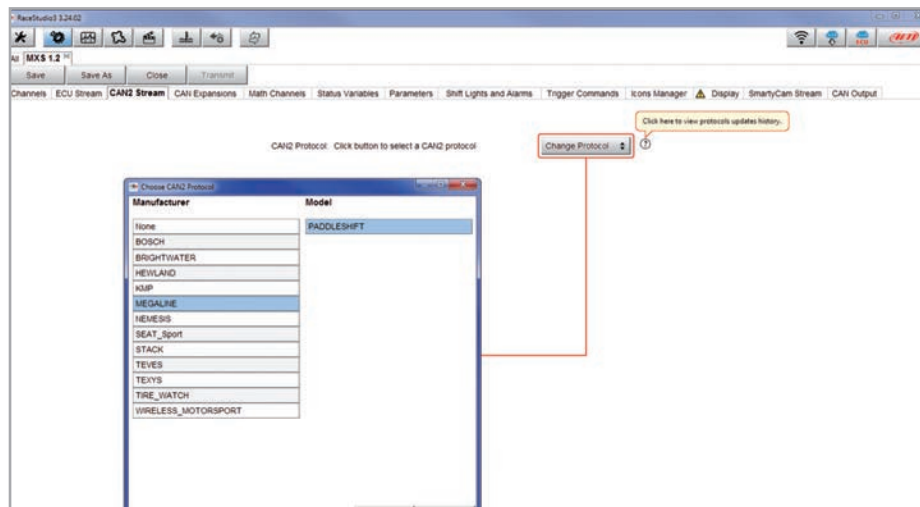

## 6.2.5 CAN Expansions configuration

MX Series can be connected to various AiM CAN expansions:

- LCU-One CAN
- Channel Expansions
- TC Hub

At the very first MX Series connection this page shows up:

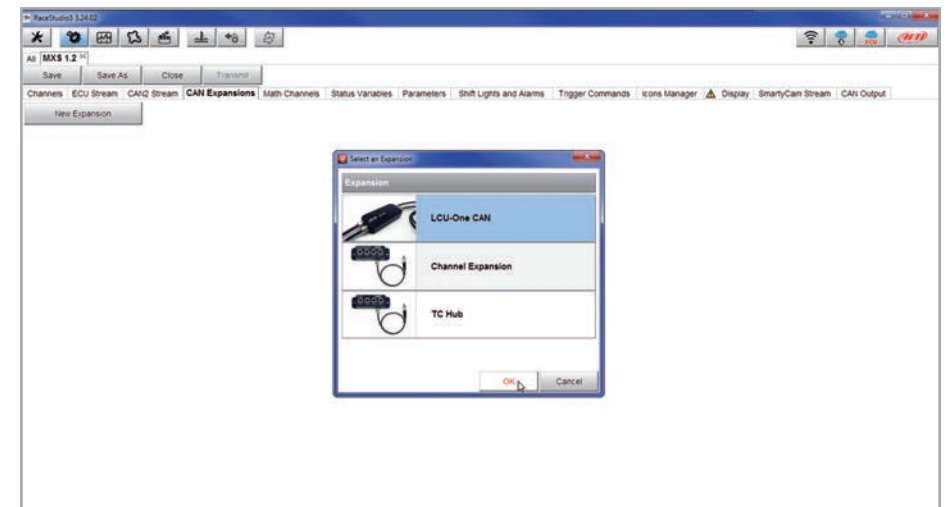

Select the CAN expansion to set and press "OK". Each expansion needs to be set filling in the related panel.

## Setting LCU-One CAN

To set an LCU-One CAN:

- press “New Expansion” button;
- select “LCU-One CAN” and press OK
- name the LCU One and fill in its serial number or press “Get SN from a connected expansion” to receive the serial number from the connected LCU-One
- select the multiplier to calculate AFR from lambda (in the example “14.57 Gasoline”) or add a custom value pressing “Add Custom Value” (the related panel shows up)
- set the LCU One channels double clicking on each channel and setting the panel that shows up (it works exactly like channels configuration – see the related paragraph)
- press “Close” to save and exit

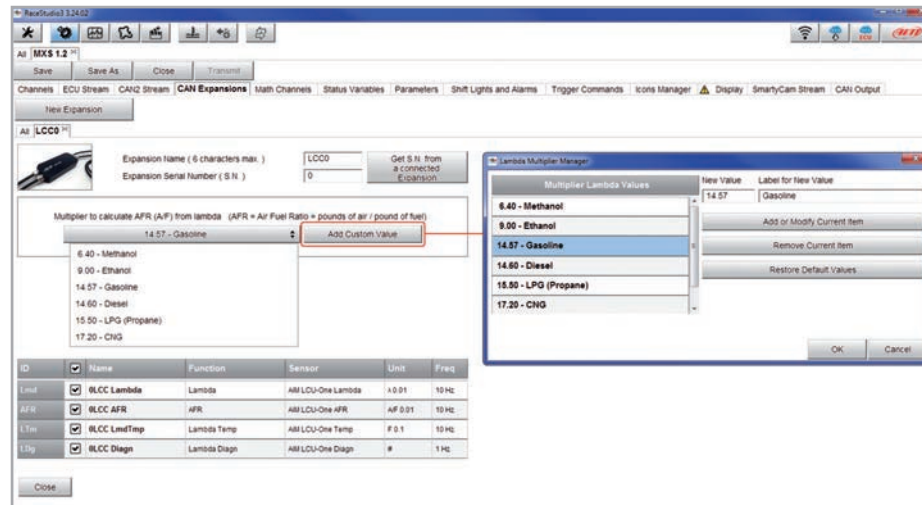

**Please note:** for any further information about AiM LCU-One CAN refer to the related user manual you find in the box or you can download from AiM website [www.aim-sportline.com](http://www.aim-sportline.com) documentation area, products section.

## Setting Channel Expansion

To set a Channel Expansion:

- press “New Expansion” button;
- select “Channel Expansion” and press OK
- name the Channel expansion and fill in its serial number or press “Get SN from a connected expansion” to receive the serial number from the connected Channel Expansion
- set each channel double clicking on each channel and setting the panel that shows up (it works exactly like channels configuration – see the related paragraph)
- press “Close” to save and exit

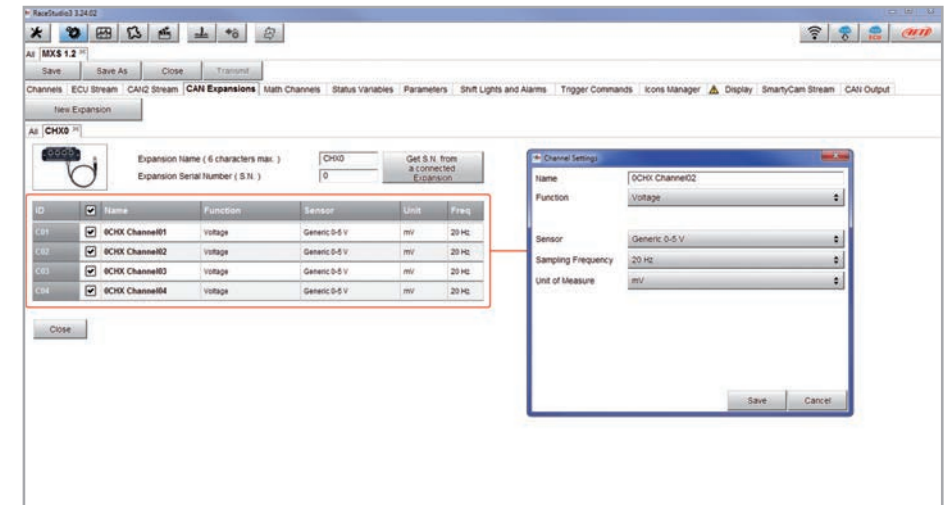

**Please note:** for any further information about AiM Channel expansion refer to the related user manual you find in the box or you can download from AiM website [www.aim-sportline.com](http://www.aim-sportline.com) documentation area, products section.

## Setting TC Hub.

This CAN expansion **only supports K type thermo-couples**.

To set a TC Hub:

- press "New Expansion" button;
- select "TC Hub" and press OK
- name the TC Hub expansion and fill in its serial number or press "Get SN from a connected expansion" to receive the serial number from the connected TC Hub
- for each channel set sampling frequency, measure unit and display precision
- press "Close" to save and exit

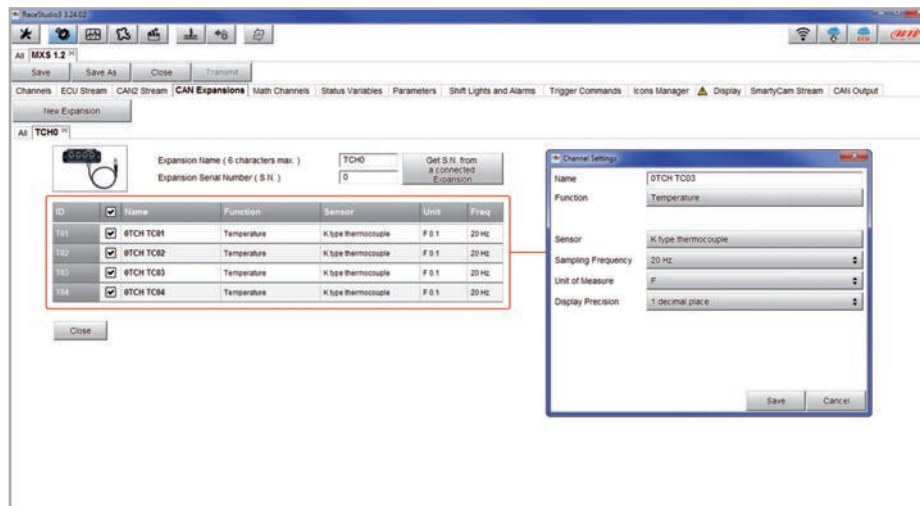

**Please note:** for any further information about AiM TC Hub refer to the related user manual you find in the box or you can download from AiM website [www.aim-sportline.com](http://www.aim-sportline.com) documentation area, products section.

## 6.2.6 Math channels configuration

To create math channels; available options are:

- Bias: considering a relation between two mutually compatible channels it computes which one is prevailing (typically used for suspensions or brakes);
  - Bias with threshold: it needs the user to set a threshold value for the considered channels; once these threshold are both exceeded the system makes the calculation;
  - Calculated gear: it calculates the gear position using engine RPM and vehicle speed
  - Precalculated gear: it calculates the gear position using Load/Shaft ratio for each gear and for the vehicle axle too
  - Linear correction: typically used when a channel is not available in the desired format or if it is wrongly tuned and cannot be tuned again
- Each option asks the user to fill in a proper panel.

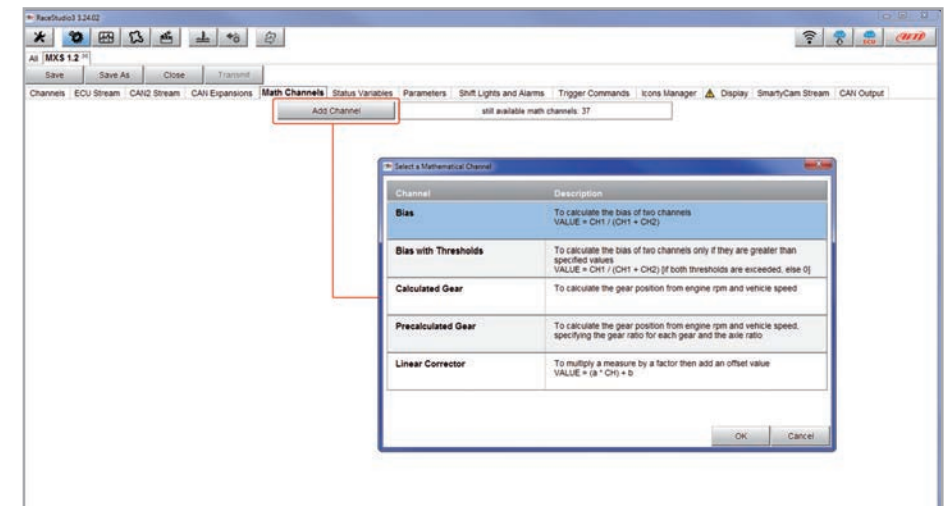

## 6.2.7 Status variables configuration

Status Variables are internal math channels that can have only two different values: 1 (TRUE) or 0 (FALSE). They may be useful for simplifying complex configurations, where it is required to evaluate if to activate alarms, LEDs, Icons etc..

Let us explain with an example: we would like to turn ON a LED and an Icon when Water temperature reaches 100°C and the RPM are higher than 2000. Instead of defining the same logic for managing the icon and for managing the LED, we could define a Status Variable, Water Temp Alarm, and link Icon and LEDs to this variable. In this case, we could define:

- Water Temp Alarm is High when:
  - Water Temp is higher than 100°C and
  - RPM is greater than 2000.

And use Water Temp Alarm for managing Icons and LEDs.

As you may see, the Status Variables are more useful when the logic to be evaluated is complex and involves different channels.

In order to define a Status Variable enter the proper TAB.

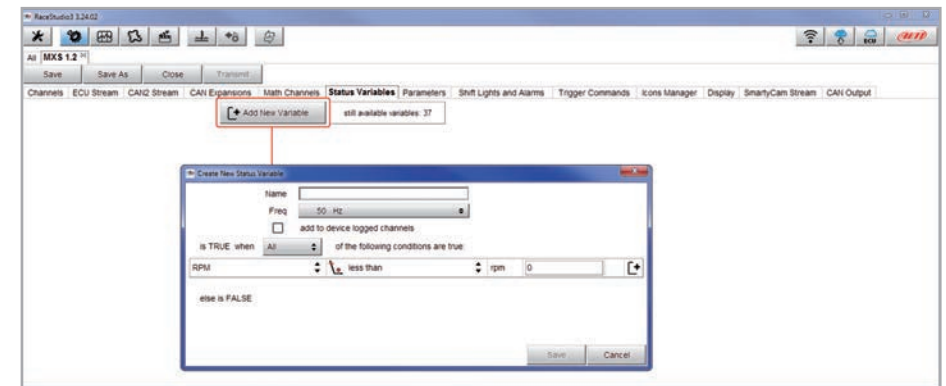

The Status variables can be used as any other channel, so they may be seen online, transmitted to the CAN stream, recorded, used for triggering a command or for turning ON a LED or an Icon. Mousing over the Status Variable a summary panel appears on the right as shown here below.

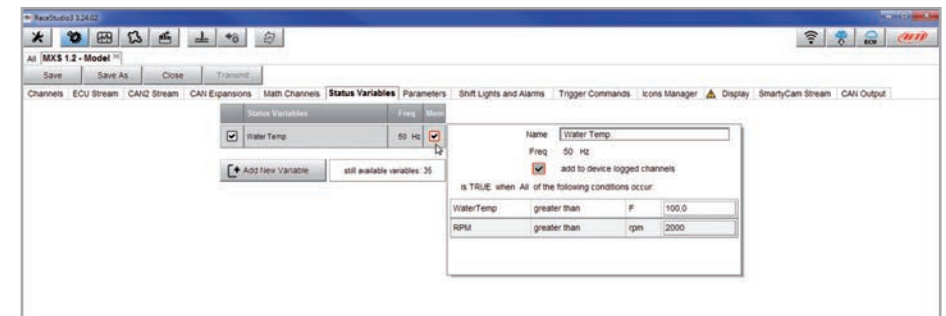



## 6.2.8 Parameters configuration

To set GPS and/or optional optical beacon (Lap detection) as well as decide the logger start data recording condition (Start Data Recording).

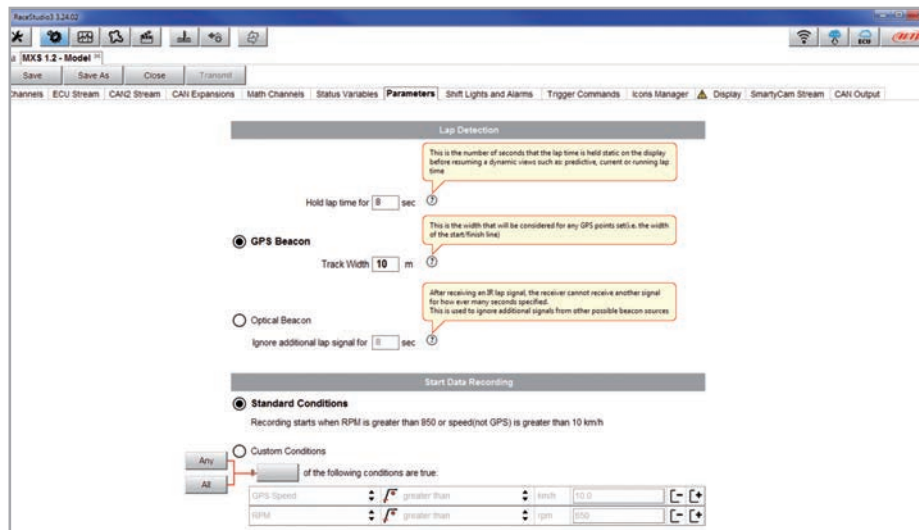

### Lap Detection

Mousing over the question marks a pop up message will explain the working mode of:

#### ■ GPS Beacon:

- hold lap time for: the time period for which lap time is shown on MX Series display
- the track width: width that will be considered for any GPS point set

#### ■ Optical beacon:

- ignore additional lap signal for: after receiving an Infrared lap signal, the receiver does not detect another signal for the time period fixed in this box. This is very useful if more lap transmitters are placed nearby on the side of the track.

### Start Data Recording

- Standard conditions: MX Series logger starts recording when RPM value is greater than 850 or speed (not GPS) is higher than 10 km/h
- Custom conditions: to set one or more custom condition(s) to make the logger start recording. Setting more conditions it is possible to decide whether only one of them or all need to be satisfied.

## 6.2.9 Shift Lights and Alarms configuration

To set shift lights (on top) and set the alarm LEDs (bottom) of MX Series.

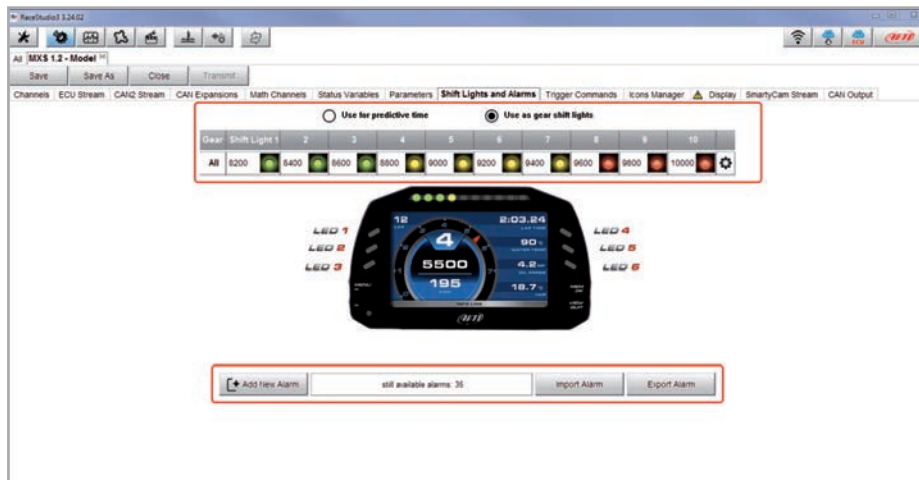

On top MX Series shift lights working mode can be set. Available options are:

- shift lights, for helping in changing gear and
- predictive time: for easily understanding if the actual lap is faster or slower than the reference lap.

**Use as gear Shift Lights** To use the led bar as shift lights click the icon (⚙️) for setting the parameters. Configure:

- at which RPM value the single LED turns ON
- the sequence mode of the LEDs enabling the desired option:
  - a LED stays on if its threshold is exceeded
  - a LED stays on until another LED with higher threshold turns on or
- link the shift lights to the engaged gear enabling the related checkbox;

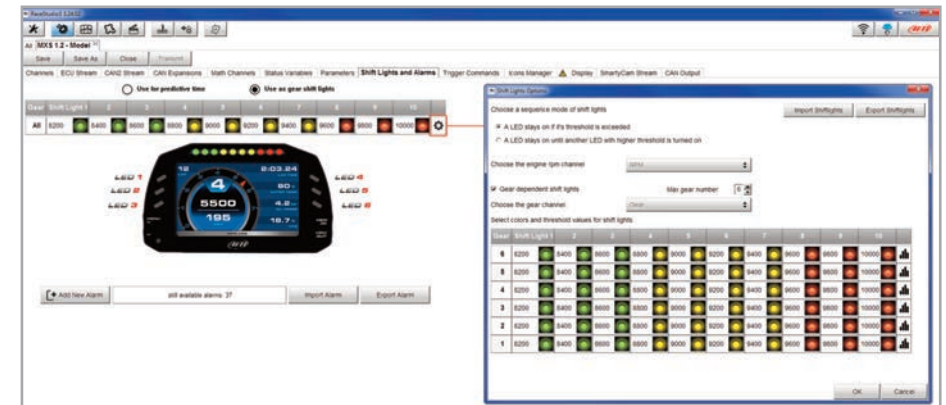

### Use for predictive time.

Click the icon (  ) for setting the parameters.  
In this case the LEDs colour are fixed in:

- Green if the lap time is improving
- Red if the lap time is worse than the reference lap

The threshold at which one LED is turned ON can be customized. Assuming “0.10 sec” is fixed and the lap time is improving of 0.30 sec toward the reference lap, MX Series will switch on 3 LEDs green; if, on the contrary, the lap time is worsening the LEDs will switch on red

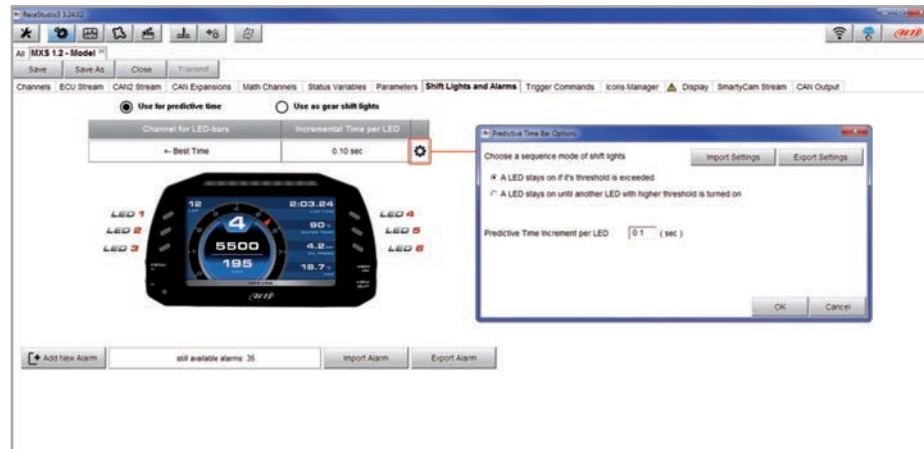

### Create and set MX Series alarm

To create a new alarm press “Add New Alarm” and the related panel shows up.



To set the new alarm:

- define the Alarm name (1)
- a combination of Alarm conditions can be set: choose if the conditions are to be ALL valid or just one of them (2-4)
- decide which action is to be triggered (5) among displaying a message or a timed popup message, display a measure, switch a LED on or activate an output signal (CAN output page, see the related paragraph)
- decide the alarm ending condition ("Until" – 6) among: condition no longer met, the device is turned off, a button is pushed or data are downloaded
- "+" buttons right of the panel are to add new alarms (the top one) or to add new actions to an alarm (bottom one)
- when all operations have been performed press "Save" in "Create New Alarm" Panel and the software comes back to "Shift Lights and Alarm" page.

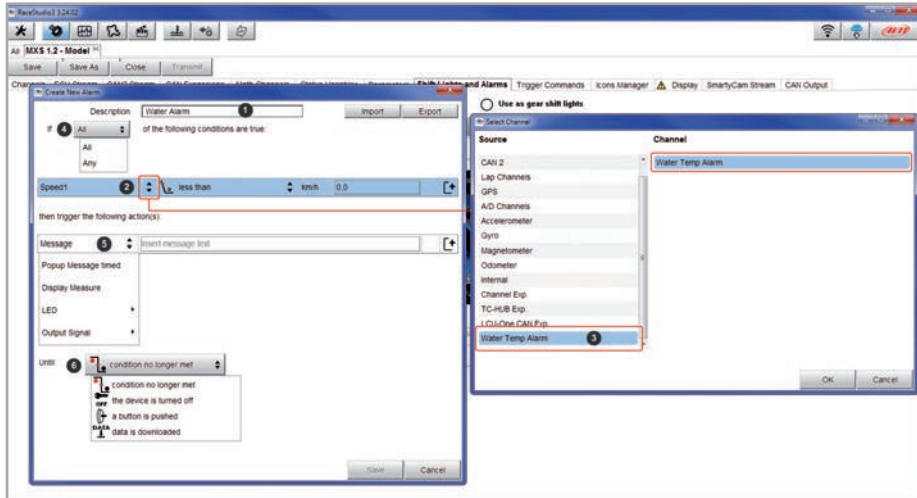

## 6.2.10 Trigger commands configuration

"Trigger Command" executes some specific actions on MX Series.

The commands available up to now are:

- set next/previous page
- show camera input page
- reset alarms
- activate pushbuttons (1- 4)

Other commands will be available in the next software/firmware releases.

To add a new command.

- Press "Add new Command" (1)
- a combination of conditions are allowed for setting a Trigger Commands and it is possible to decide whether the conditions are to be ALL valid or just one of them (2-4)

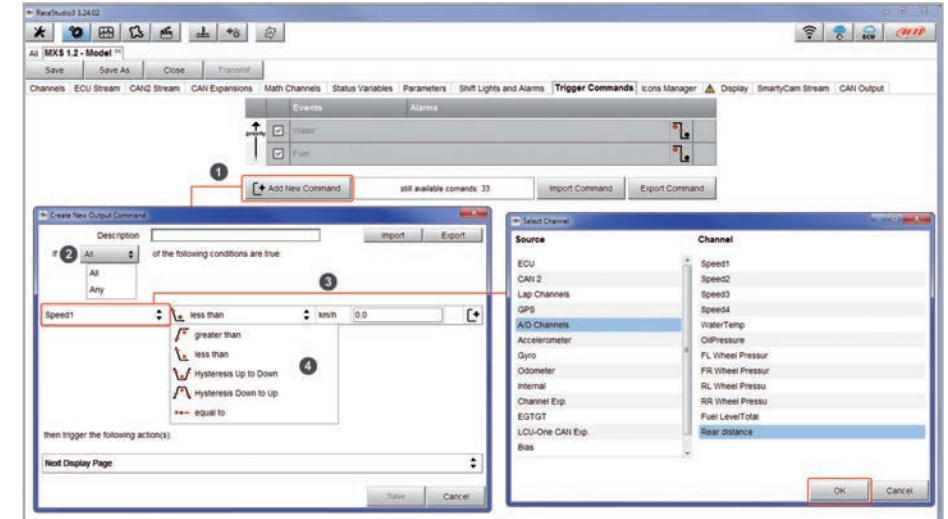

- decide the action to be performed (5)
- Click "Save"

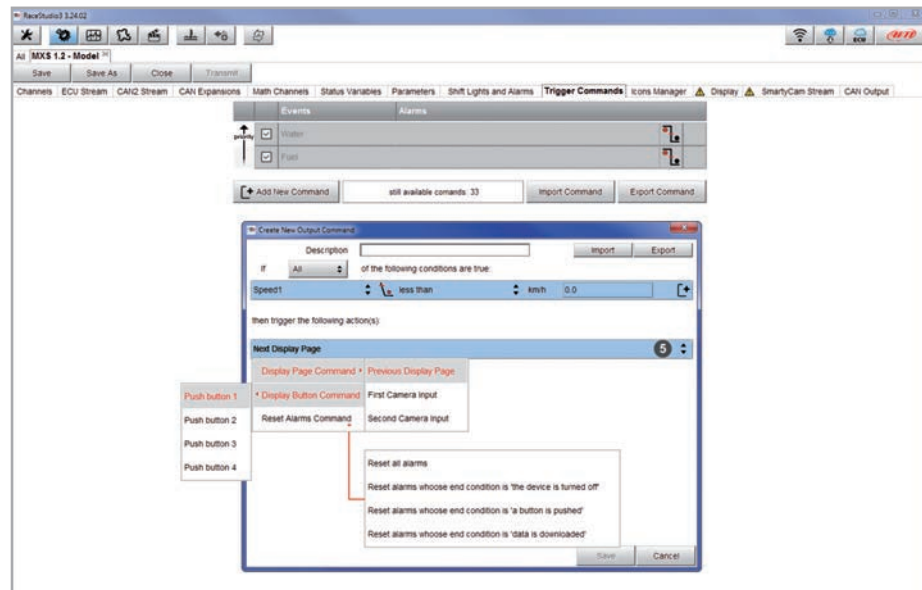

In the Trigger Commands summary page, trigger command can be modified/deleted right clicking on the setting icon placed right of the trigger row.

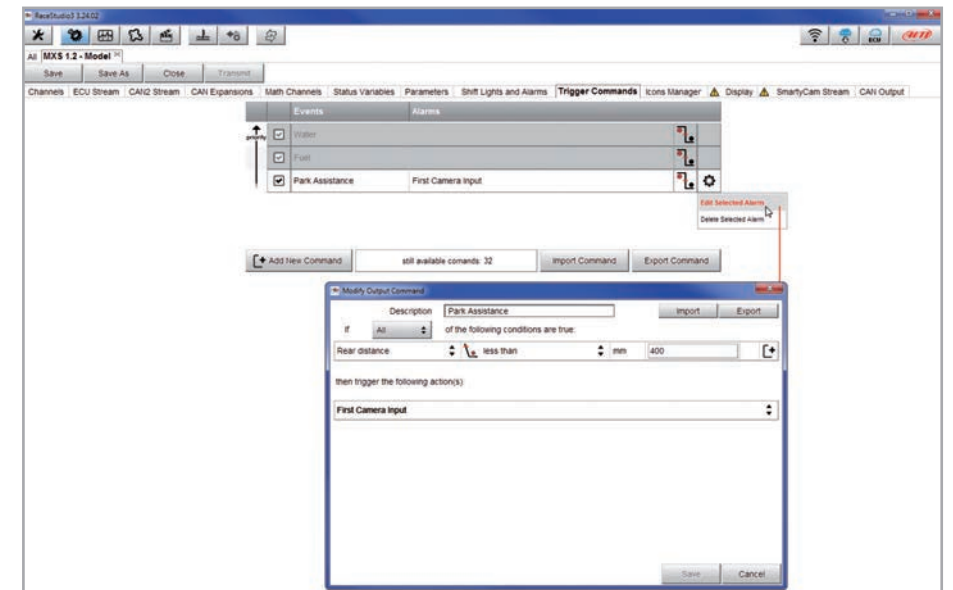

## 6.2.11 Icons manager configuration

The "Icon" are a set of images, each of them to be shown on every page as desired, that depend on a fixed condition that, when exists, triggers the proper image.

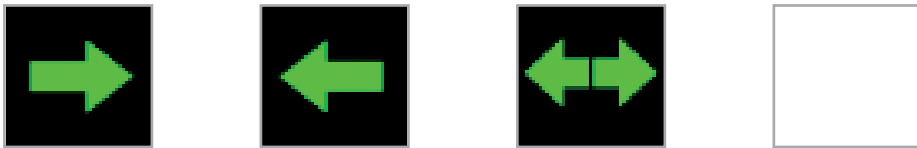

For example:

- the first image has to be shown when the signal Turn Right is TRUE
- the second when the signal Turn Left is TRUE
- the third when the signal Hazard is TRUE
- the fourth when no signal is TRUE

Not all display pages offer the possibility to show icons but our technicians are working for offering more pages with this feature.

To configure an Icon

- press "Add New Icon"
- "Manage Icon" panel shows up
- press "Select" to see the panel showing all images
- select the image to set
- the software comes back to "Manage Icon" panel
- set the image conditions according to the channel they are related to

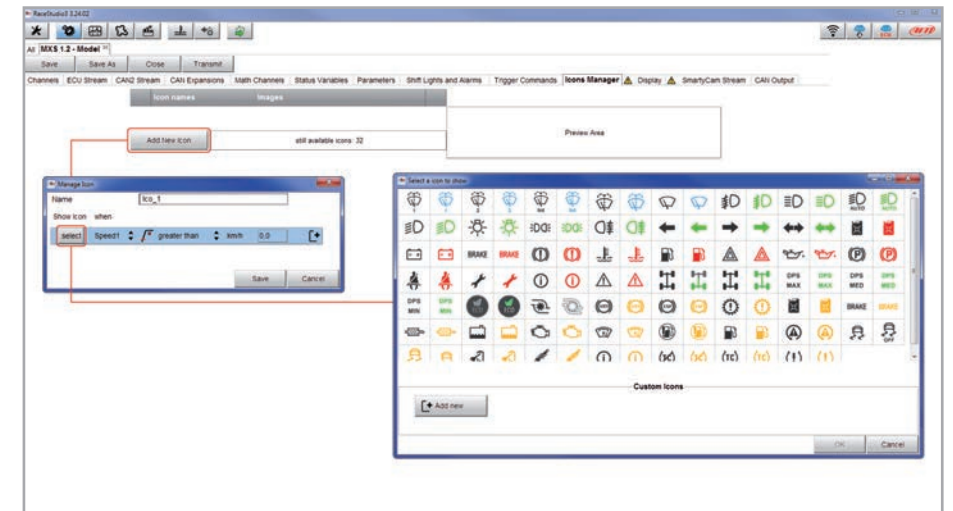

It is possible to use custom images pushing the "Add New Icon" pushbutton. They have to be 64x64 pixels .png format.



The “Icons page” shows a summary of the selected icons. If you mouse over any icon, a panel with all the information appears.

Icons can be edited/selected pressing

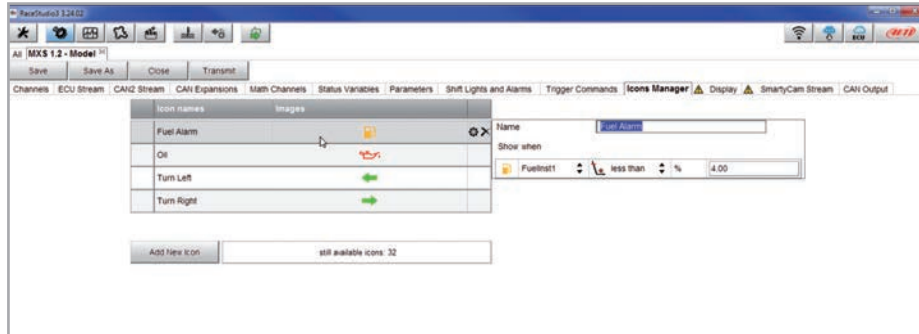

## 6.2.12 Display configuration

MX Series can have up to eight pages to be set via software.

- enter “Display” tab
- a panel shows up: select a display page (in the example a page with icons bar has been chosen)
- select the page and press “OK”
- repeat the operation for the number of pages to set



When the page has been selected two setting panels appear bottom of the page:

- on the left a panel that shows as many rows as the fields to be set
- on the right a panel that shows the channels group that can be set in that field and all the channels in it included; drag and drop the channel to set in the desired field or double click on it
- if more display pages have been added a label top of the tab indicates the one in use as highlighted here below.



## 6.2.13 SmartyCam stream setting

MX Series can be connected to AiM SmartyCam to show the desired data on SmartyCam video.

To set each channel:

- click on it and a setting panel shows up
- it shows all channels and/or sensors that fits the selected function
- in case the desired channel or sensor is not in the list enable "Enable all channels for functions" checkbox and all channels/sensors will be shown

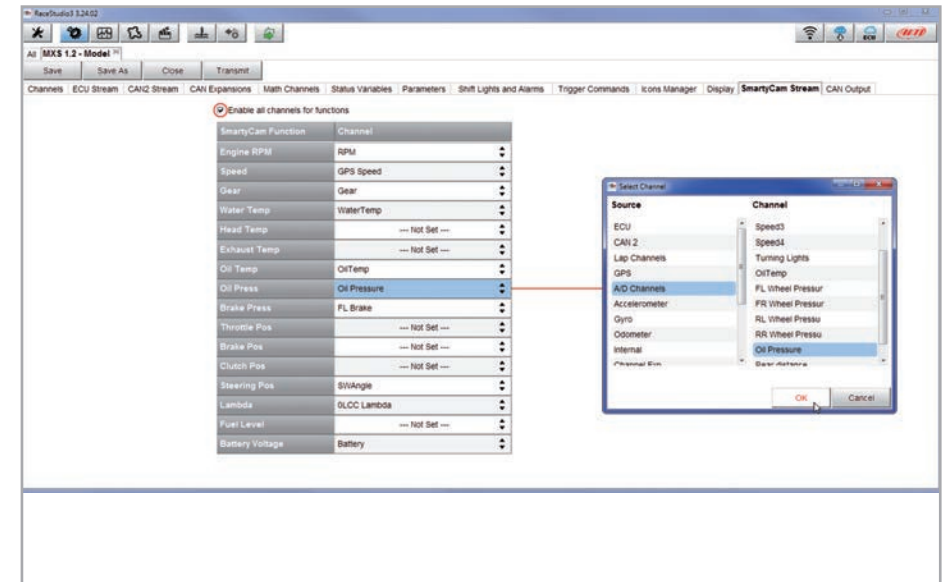

## 6.2.14 CAN Output configuration

Please note: this function is for expert users only.

At very first configuration this panel shows up.

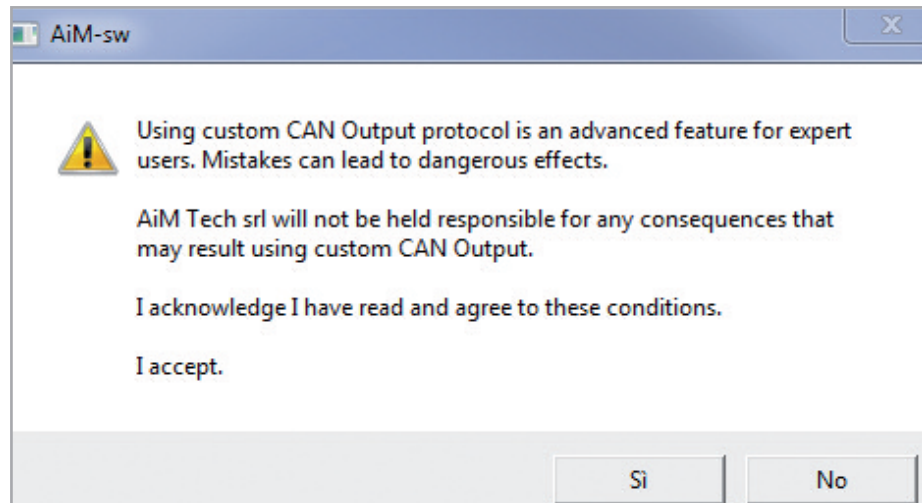

The logger can transmit a CAN data stream containing the channels required both on CAN1 and CAN2.

To add a payload:

- press "+Add new Payload" and "Set CAN Header details" appears;
- fill in ID CAN (hex), available options are:
  - 11 bits (normal address)
  - 29 bits (extended address)
- select the payload max bytes number (DLC), available options are from 1 to 8 bytes
- select the byte order according to the used processor, available options are:
  - Little endian for Intel processor
  - Big Endian for Motorola processor
- set the sampling frequency among: 1, 2, 5, 10 or 20 Hz

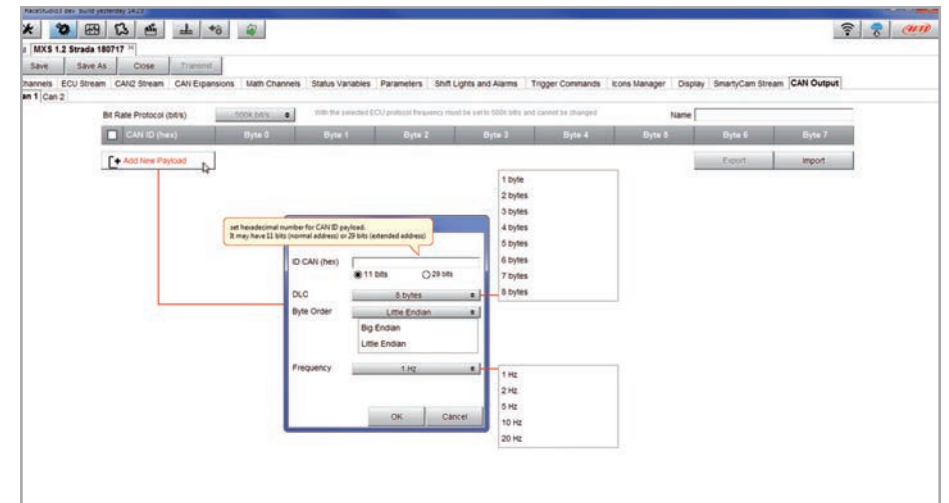

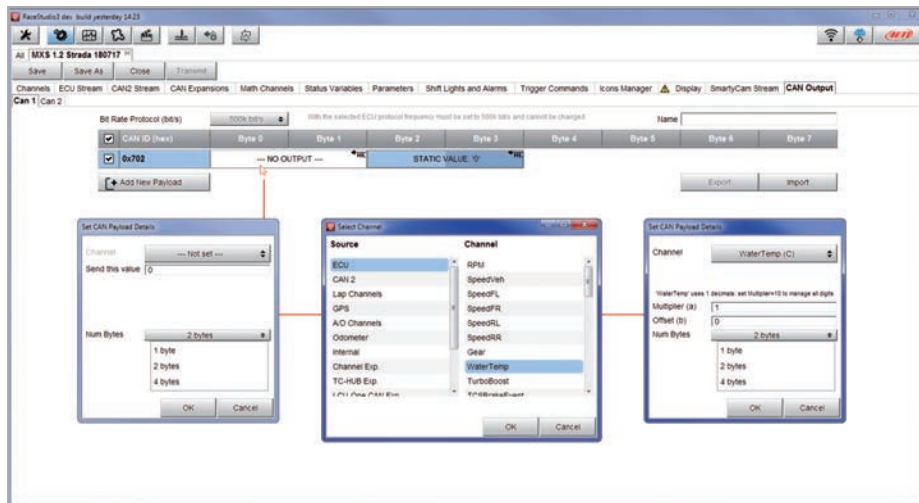

When all channels set the configuration is finished:

- press "Save" on the page top keyboard
- press "Transmit" to transmit the configuration to MX Series



## 6.3 Managing a track on MX Series with Race Studio 3

With Track Manager function of Race Studio 3 tracks can be created, deleted and modified, transmitted and received to/from MX Series. Press "Tracks" icon.



The main page is divided in three columns; **on the left:**

- on top, the filters that allow to collect many tracks following customized criteria; by default, all tracks are shown (light blue "All Tracks" filter in the image below).
- bottom left, the connected devices (in the image, "MXS 1.2 ID 4202523")

The column **in the middle** shows:

- on top a fast search bar that allows to select the tracks which satisfy personal research criteria; pressing "?" a pop-up window explains research criteria (highlighted in red below), to say:
  - long name is the name in bold in each track box
  - short name is the track name shown on the display of MX Series and is the name shown top right of each track box
  - track city is the name of the city the track is located in
- all the tracks listed in Race Studio 3 database. It automatically updates at start up if a connection to the Internet is available.

The column **on the Right** shows:

- the data sheet of the track you are mousing over.

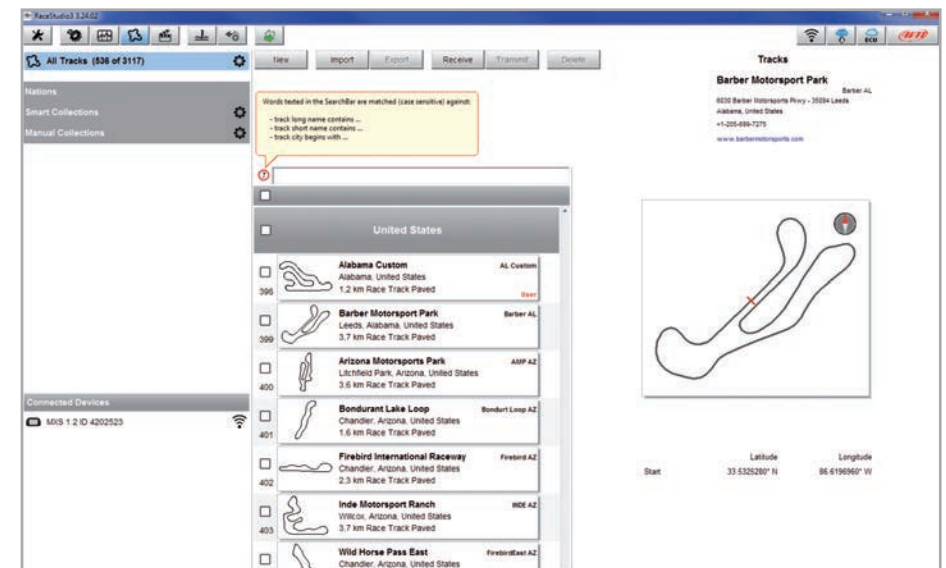

When MX Series is connected it is shown on the left bottom part of the page as said before. Clicking on it all the tracks it contains are shown in the right column of the page.



Tracks created by the user are labelled "User" and if the track stored in MX Series logger is different from the one stored on AiM database this is notified as shown here above.

The page keyboards are used to manage the tracks.

The keyboard above the central column allows to:



- **New:** create a new track
- **Import:** import one or more tracks stored in the device or in another external device
- **Export:** export one or more tracks to a specific PC folder or to another peripheral device
- **Receive:** receive from the connected device tracks user created (if no device is connected the button is disabled)
- **Transmit:** transmit one or more tracks from the PC to the connected device (if no device is connected the button is disabled)
- **Delete:** delete one or more tracks from Race Studio 3 database

The keyboard above the right column allows to:



- **Refresh:** refresh the track list stored in the connected device
- **Delete:** delete one or more tracks from the device memory
- **Delete All:** delete all tracks stored in the device memory
- **Save all:** save all the tracks stored in the connected device; it creates a zip file that can be loaded to another AiM device
- **Load Saved:** load the tracks previously saved in the device memory

Since the software is constantly updated, may be other information or features will be available soon. Please check our website [www.aim-sportline.com](http://www.aim-sportline.com), documentation area, software section "Track Manager" manual.



## 6.4 ECU Driver builder

If the vehicle ECU is not included in Race Studio 3 software a specific CAN protocol can be created using CAN Driver builder.

**Please note: this Race Studio function is for expert users only.**

It is possible to add a new ECU Manufacturer and/or a new ECU model. To do so:

- press “New” on the top central keyboard
- “New Custom CAN Protocol” panel shows up
- press “Add Manufacturer” to add a new Manufacturer and “Custom Protocol Manufacturer Manager” panel shows up
- fill in the Manufacturer name (“Custom” in the example below)
- press “OK”
- to add a new ECU Model for an existing Manufacturer just select the manufacturer and fill in “Edit new model name” box.

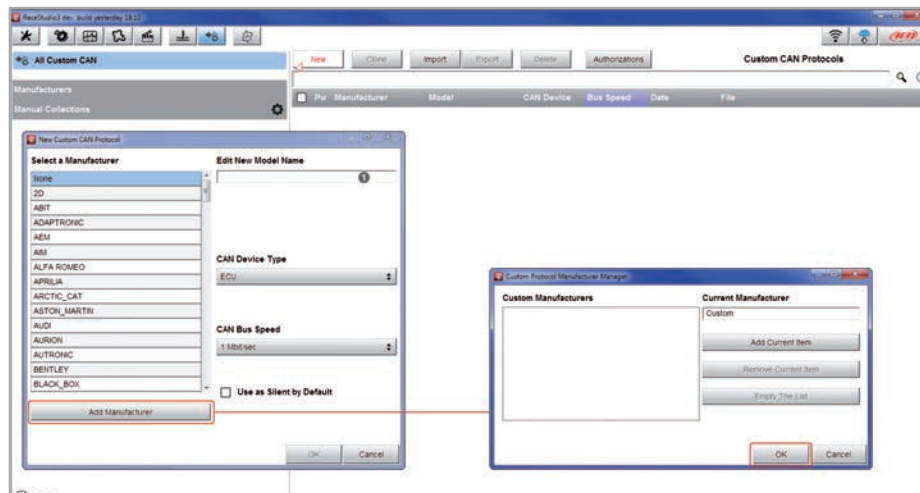

The software comes back to “New Custom CAN Protocol”:

- select the ECU Manufacturer previously created
- fill in the Model name in the panel top right box
- select the CAN Device type; available options are:
  - ECU
  - other CAN Devices
- select the CAN Bus speed; available options are:
  - 125 Kbit/sec
  - 250 Kbits/sec
  - 500 Kbit/sec
  - 1 Mbit/sec
- if the network features multiple devices we suggest to enable “Use a Silent by Default” checkbox
- press “OK” and a new CAN Driver has been added

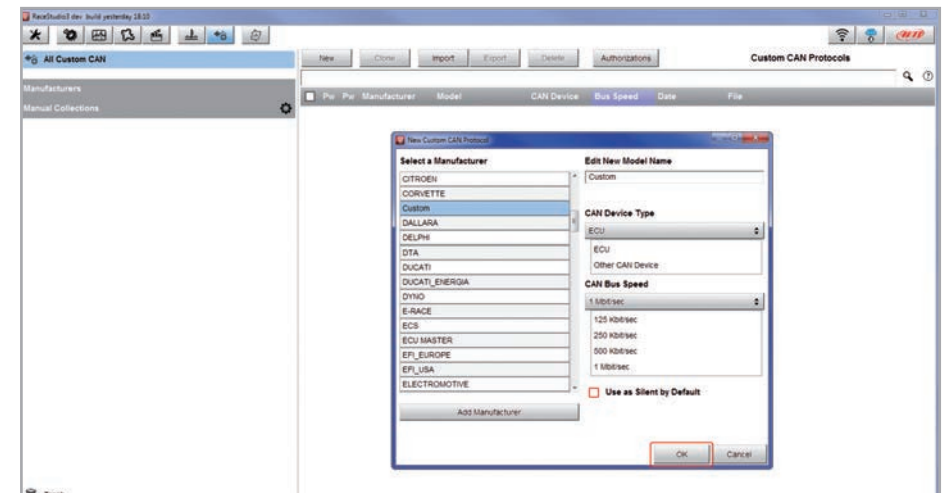

For further information about how to set the new CAN Driver refer to the CAN Driver builder user manual downloadable from [www.aim-sportline.com](http://www.aim-sportline.com), documentation area software/firmware section.



## 6.5 The device window

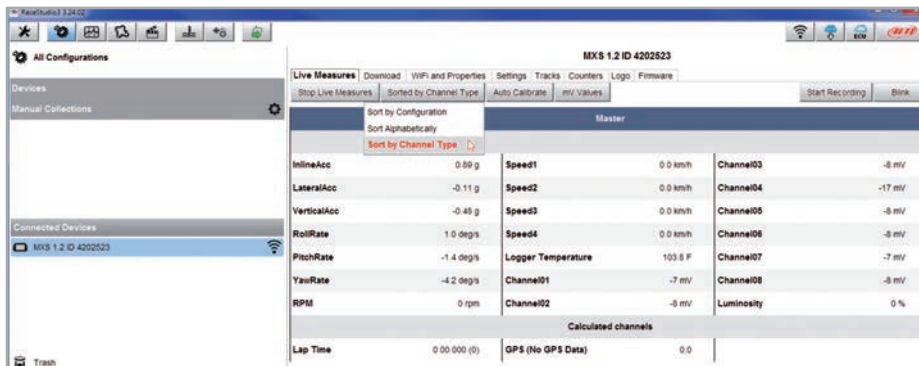

The device window is shown clicking the device bottom left of the software page. Here are:

- **Live Measures:** to check all device channels and force online values; to:
  - start live measures
  - sort the channel visualization as preferred: as managed by the firmware (sort by configuration), alphabetically, by channel type (they will be shown by device then by channel type and at the end by measure type)
  - calibrate sensors that need the calibration
  - show the measure in Mv
- **Properties:** to name the device, fill in racer's and vehicle name or number, championship and venue type (generic or qualifying testing, warm up, race, test type)
- **Settings to:**
  - set date
  - enable/disable daylight time
  - set time format and time zone
- **Tracks:** to manage the tracks stored in the device memory
- **Counters:** to set reset the device odometers
- **Logo:** transmit/receive the logo that shows up when switching the device on; supported image format are JPEG or BMP; always use the most recent Windows™ versions (Windows8 or Windows10) whose graphic libraries are more updated
- **Firmware:** to check or update MX Series firmware version

### 6.5.1 Live measures layer

Once the configuration has been transmitted "Live Measures" page shows ECU Channels too and some operations can be performed, like start recording and stop live measures as well as making the device blinking pressing the button top right of the page. This last operation is the easiest and quickest way to test PC-Device communication.

### 6.5.2 Online value forcing

Starting from Race Studio 3.24.02 Device page Live measures layer features a new and very useful option: online measure value forcing. This feature allows the user to simulate one or more channels value to test icons, alarms, power output and harnesses behaviour. With reference to the configuration we created it is possible to verify if Water Alarm status variable works.

The set conditions (paragraph 6.2.9) are: water Temperature greater than 100 +RPM greater than 2000. To force these values:

- mouse over the value to force and click the setting icon
- a popup menu appears: select "Force Value" option and fill in the panel that appears
- Click "OK" and the LED blinks continuously as set in the device configuration.

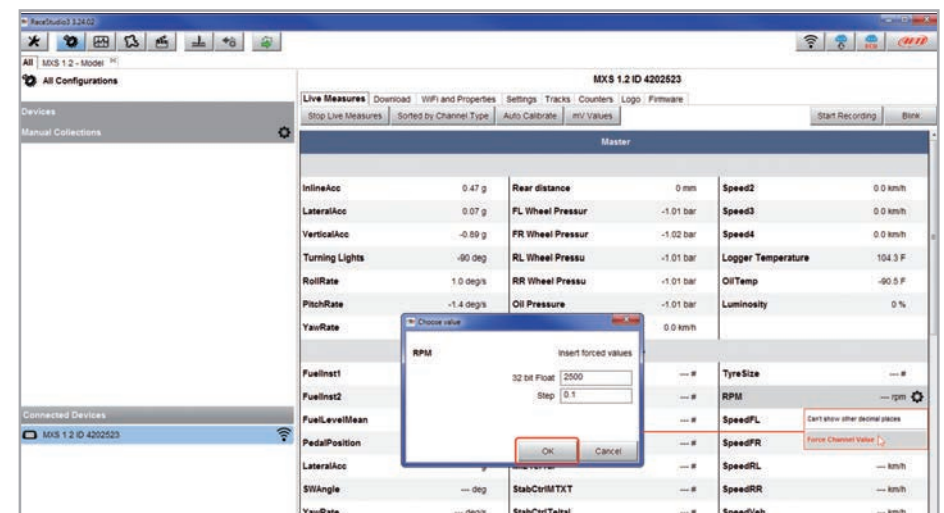

As shown in the image below, once the values have been forced they are shown right of the page hedged in red. With the two "+" and "-" lateral buttons it is possible to change the forced values.

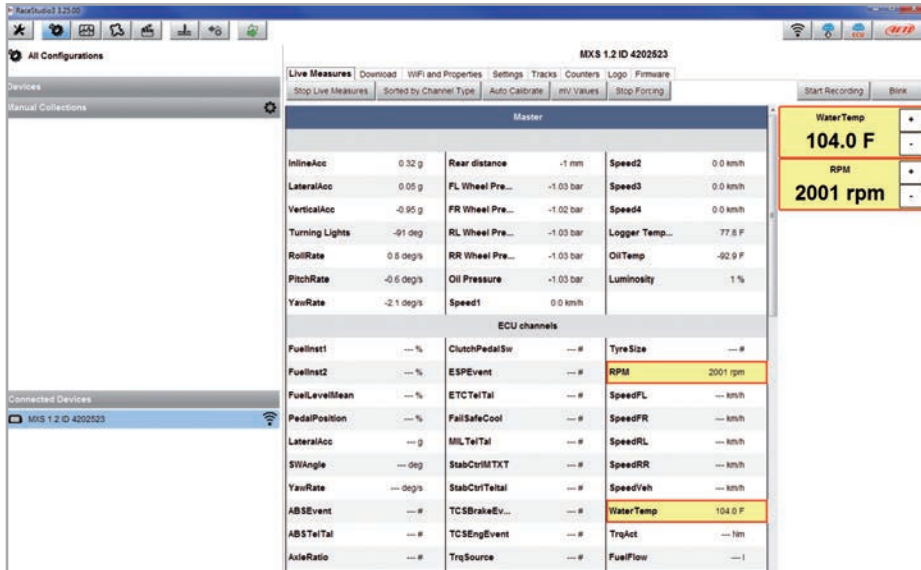

## 7 On the track

MX Series can show up to eight pages. To scroll them press ">>" lateral button. Pages can change according to the device configuration.

## 8 Data recall

At the end of the test sampled data can be recalled pressing "MEM/OK".

First is "Today" page.  
Press "TESTS"

TODAY 02.02PM			
MAX RPM		MAX SPEED	
10048		282	
Lap	Best Laps	RPM	Km/h
4	1:57:56	10048	280
		5592	73
11	1:57:94	10100	277
		5450	70
8	1:58:02	10300	278
		5700	69

Second is "Summary" page that shows all the last tests with date and place. Select the day you see and press "ENTER".

TEST SESSIONS	
TODAY: COTA(Austin)	
21/07/2018:	Albany GA
21/07/2018:	Albany GA
20/07/2018:	Albany GA
20/07/2018:	Albany GA

Third is "Summary" page that shows all tests in a box with time of the test, number of laps and best lap of the test. Select the test to see and press "ENTER".

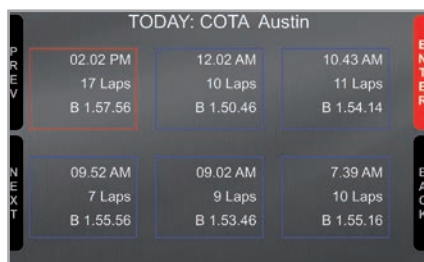

This page is a histogram test summary. Moving the cursor left and right all laps and their lap time are shown.

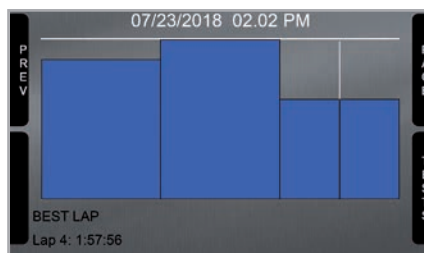

## 9 Data Download and Analysis



Once the test session is over it is possible to download data sampled on a PC. Connect MX Series logger to a PC using the USB cable included in the kit or via Wi-Fi and click on it bottom left of the software page. Once reached the device page activate "Download layer". It shows all the information concerning the file stored in the logger: number of laps, best lap, date/time, file dimensions. Select the file(s) to download and press "Download" button.

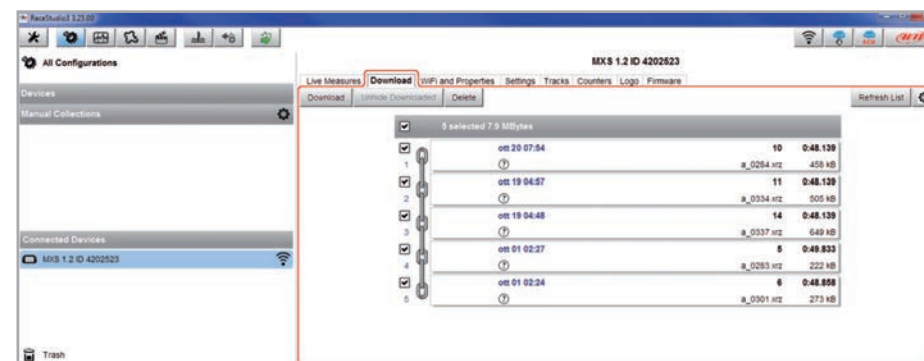

After download press Analysis Icon (  ) and Race Studio Analysis software starts showing all the files available for analysis. Double clicking on the desired one it is possible to start analysing your performance.

## 10 New firmware upgrade

Our technicians and engineers are constantly working to improve both the firmware (the application that manages the device) and the software (the application installed on the PC).

Each time a new firmware and/or software version is available the icon here above appears with an arrow indicating that something is available for download (otherwise the icon only shows the cloud).

Click it and freely download the new applications.

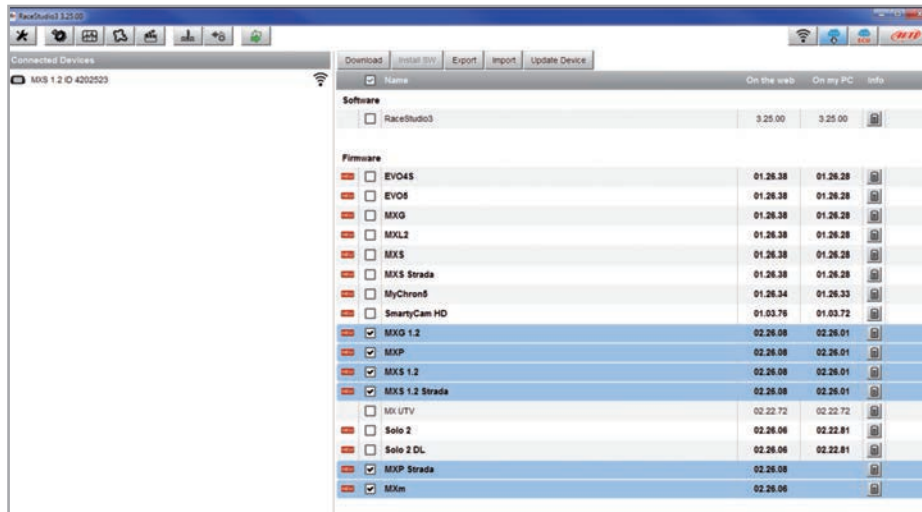

Once the new firmware has been downloaded connect the device to the PC using the USB cable included in the kit or via Wi-Fi to perform a firmware upgrade. In a few seconds the device is ready.

## 11 Connection with the expansions

MX Series can be connected to AiM GPS08 Module, LCU-One CAN, Channel expansion, TC Hub, SmartyCam HD and SmartyCam GP HD in order to improve its functionality.

**Please note** that LCU-one, Channel expansion TC HUB and Smartycam HD have to be configured with Race Studio 3 software as already explained in the related paragraphs (“CAN Expansions configuration”, “Channels configuration” and “SmartyCam stream setting”).

Moreover, for further information concerning AiM expansions and AiM SmartyCam HD refer to the related manuals.

## 11.1 Rear cameras connection and management

MX Series loggers can manage rear cameras through the 5 pins Binder 712 female connector labelled "VIDEO IN" and placed rear central as shown here below. Please see the logger pinout reported in chapter 12 (Technical information and drawings) for further information about the Binder pinout.

The connector allows the connection of up to two analog cameras.



Rear cameras needs to be connected to the logger, set in the logger configuration through Race Studio 3 software and executed through the logger keyboard. Here follows explanation of how to perform all these operations.

A wide number of analog cameras, both PAL and NTSC, are compatible with MX Series loggers and patch cables for connecting most of them are available. Please refer to our website [www.aim-sportline.com](http://www.aim-sportline.com) for more information about them.

**Please note:**

rear camera dimensions and MX Series camera input pinout are shown in chapter 12.

Once "Gear" channel has been set it is necessary to create a new "Trigger command". To do so

- press "Add new command"
- fill in the panel that shows up, in the example
  - Description: park assistance
  - channel "Gear equal to R"
  - trigger the command "First camera input"

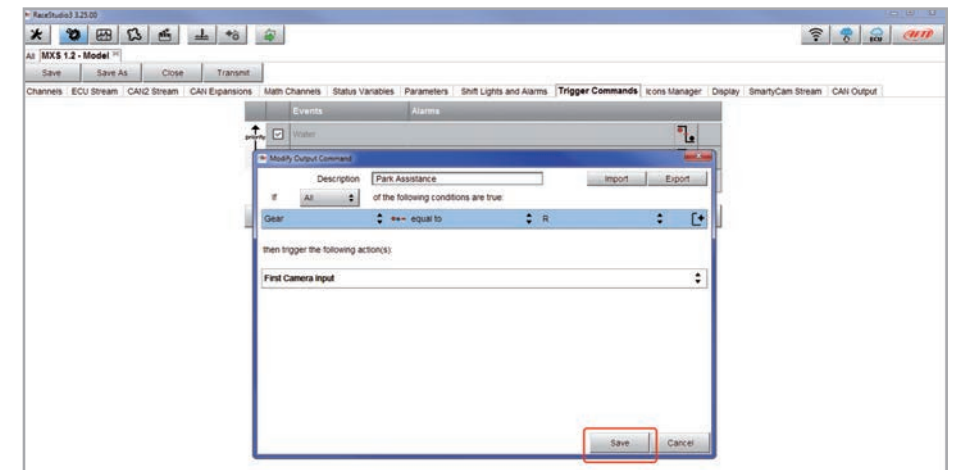

To perform the command on the logger press "MENU" button and scroll up to "VIDEO IN".



Set the camera as explained in paragraph 4.3. If no key is pressed in 5 seconds, the menu disappears and the logger shows the camera image in live streaming, that is very useful to check the camera position. Images below shows the image of the camera set on the left and the live stream on the right.

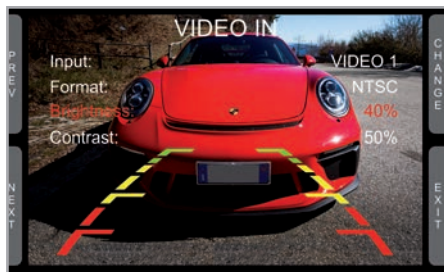

## 12 Technical specifications and drawings

■ TFT display dimensions	5" (MXS 1.2) 6" (MXP) 7" (MXG 1.2)
■ Display resolution	800x480 pixels
■ Contrast	600:1 (MXP, MXS 1.2) – 1000:1 (MXG 1.2)
■ Brightness	700cd/m <sup>2</sup> – 1,100 Lumen
■ Ambient light sensor	Yes
■ Alarm display icons	Yes, freely configurable
■ Alarm RGB LEDs	6 (MXS 1.2), 5 (MXP), 8 (MXG 1.2)
■ Shift lights	10 configurable RGB LEDs
■ Display pages	Up to 8 freely configurable
■ Backlight	Yes
■ CAN connections	3
■ Second CAN	Yes
■ ECU Connection	CAN, RS232, K-Line to 1.000+ leading ECUs
■ External Modules	GPS Module, Channel Expansion, TC Hub, Lambda Controller, SmartyCam HD
■ Analog inputs	8 fully configurable, max 1.000 Hz each
■ Digital inputs	4 Speed inputs, lap signal, coil RPM input
■ Digital outputs	2 (1A max)
■ Wi-Fi connection	Yes
■ Inertial platform	Internal 3 axis gyro, magnetometer and ±5G accelerometer
■ Internal Memory	4GB
■ Power consumption	400 mA
■ Pushbuttons	Metallic
■ Connectors	2 motorsport connectors + 1 Binder connector
■ Body	Anodized Aluminum
■ Weight	530g (MXS 1.2) – 640g (MXP) – 950g (MXG 1.2)
■ Dimensions	169.4x97x23mm (MXS 1.2) - 189.6x106.4x24.9mm (MXP) 237x127.6x26mm (MXG 1.2)
■ Waterproof	IP65



MX Series pinout

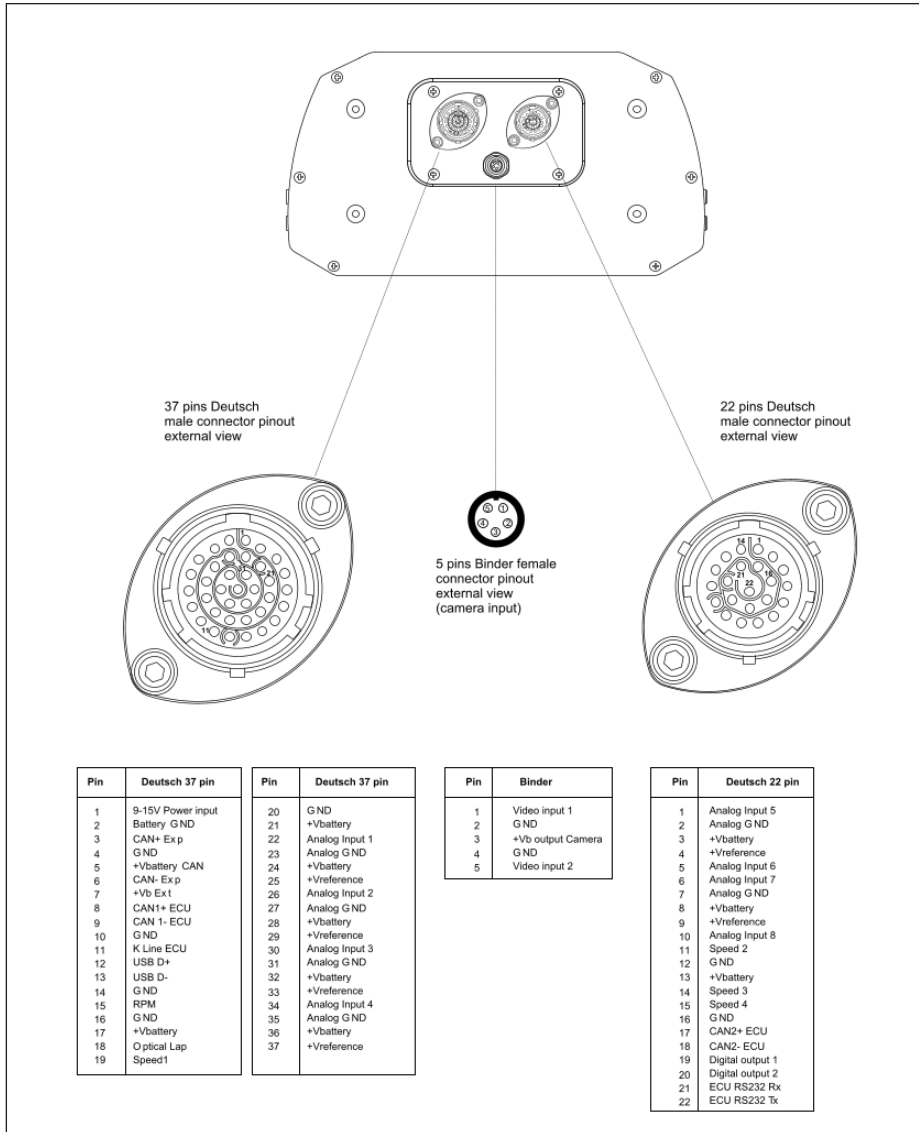

MXG 1.2 dimensions in mm [inches]

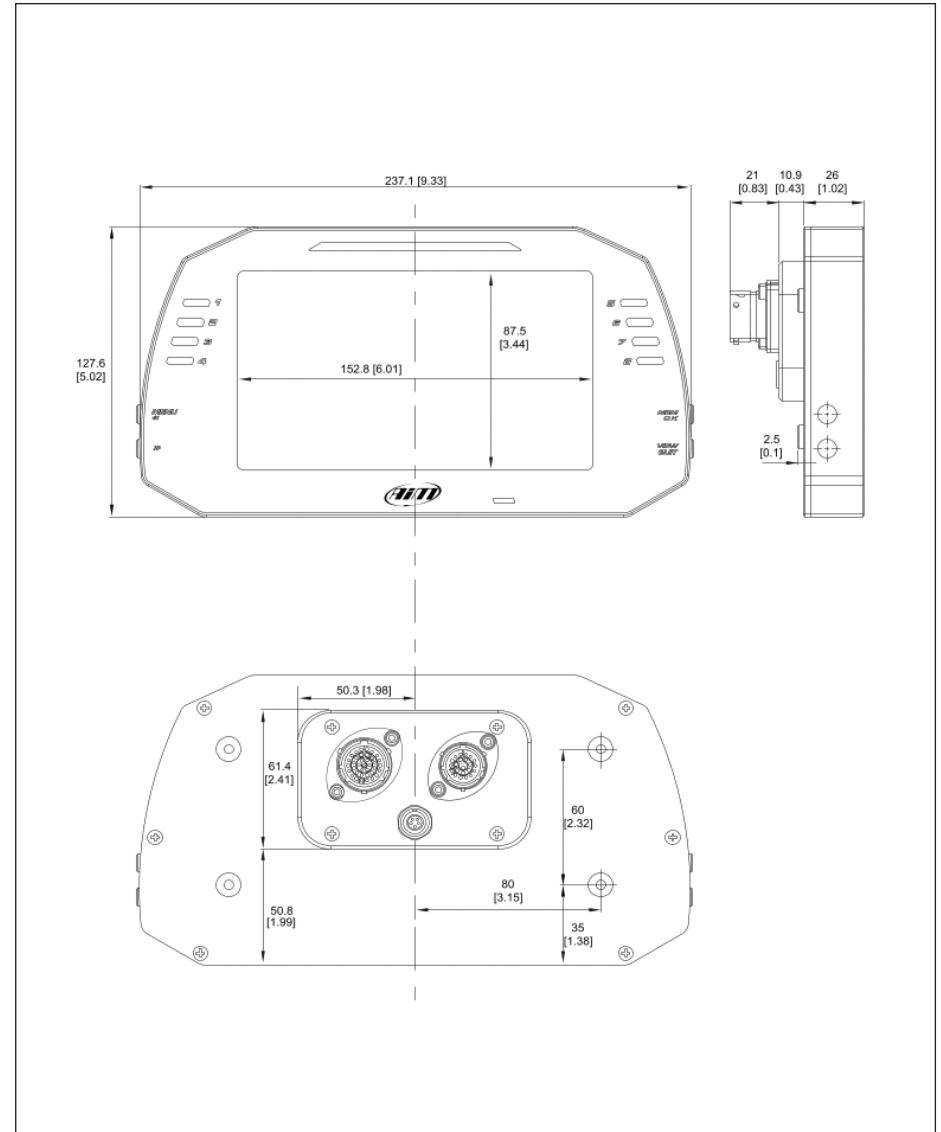

MXP dimensions in mm [inches]

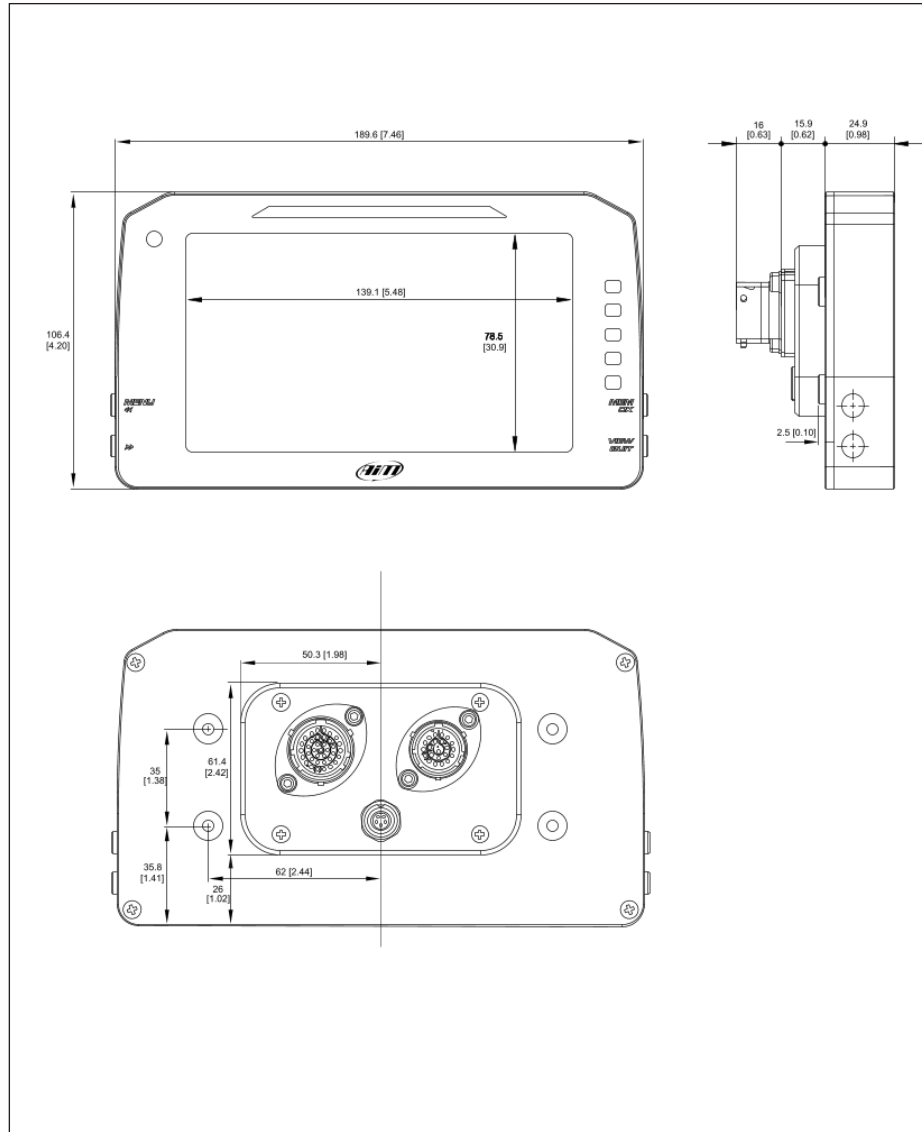

MXS 1.2 dimensions in mm [inches]

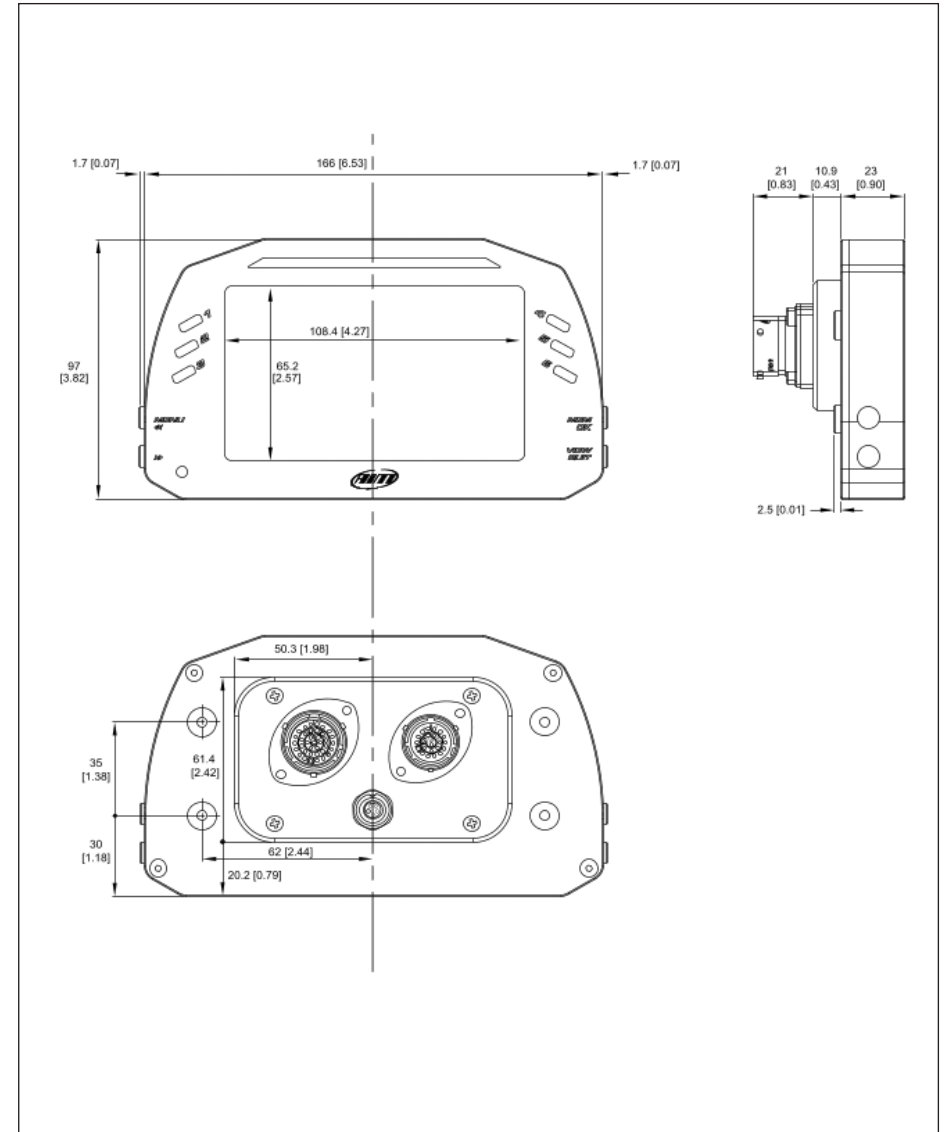

### MX Series loggers 37 pins Deutsch connector standard harness

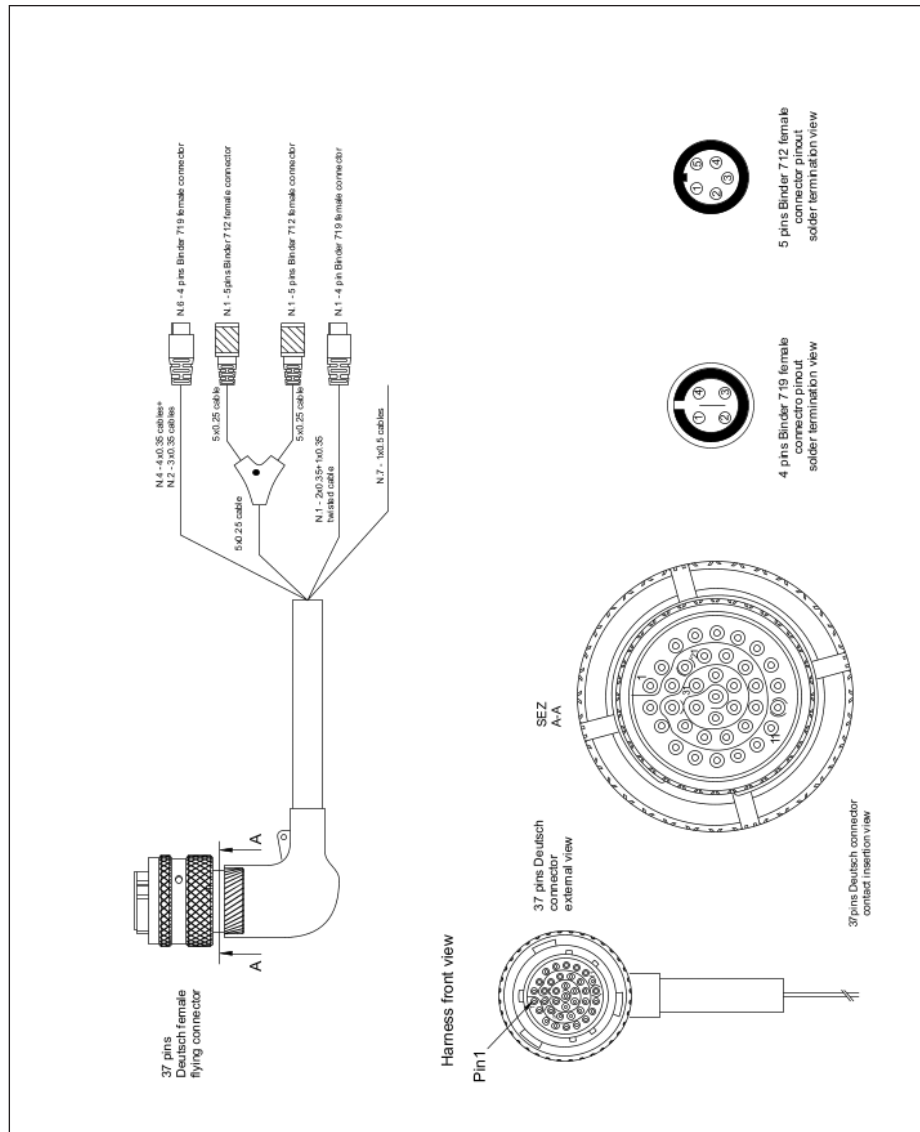

**Table cables ending with 4 pins Binder 719 female connector**

37 pins Deutsch connector pin	Cable colour	Destination connector pin	Cable type	Length	Channel	Label
22	White	1	4x0.35mm <sup>2</sup>	340mm	Analog channel 1 GND V Battery V Reference	Ch.1
23	Black	2				
24	Red	3				
25	Blue	4				
26	White	1	4x0.35mm <sup>2</sup>	340mm	Analog channel 2 GND V Battery V Reference	Ch.2
27	Black	2				
28	Red	3				
29	Blue	4				
30	White	1	4x0.35mm <sup>2</sup>	360mm	Analog channel 3 GND V Battery V Reference	Ch.3
31	Black	2				
32	Red	3				
33	Blue	4				
34	White	1	4x0.35mm <sup>2</sup>	360mm	Analog channel 4 GND V Battery V Reference	Ch.4
35	Black	2				
36	Red	3				
37	Blue	4				
19	White	1	3x0.35mm <sup>2</sup>	320mm	Speed 1 GND V Battery n.c.	speed 1
20	Black	2				
21	Blue	3				
	n.c.	4				
16	n.c.	1	3x0.35mm <sup>2</sup>	320mm	n.c. GND V Battery Optical lap	Lap
17	Black	2				
18	Blue	3				
	White	4				
12	White*	1	2x0.35+1x0.35 twistato	1100mm	USB D+ GND USB D- n.c.	USB
14	Black	2				
13	Blue*	3				
	n.c.	4				

\*= twisted

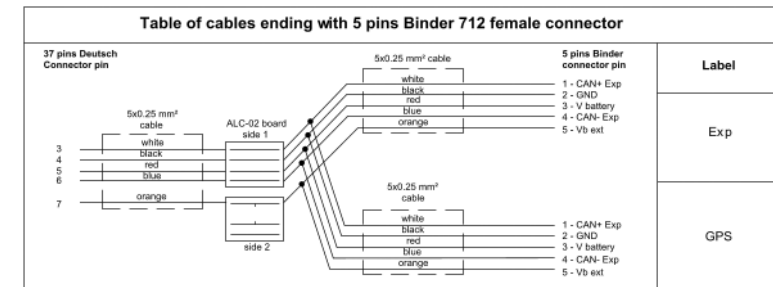

**Table of not ended cables**

Connector pin	Cable colour	Cable type	Length	Label
15	white	1x0.5mm <sup>2</sup>	550mm	RPM
2	black	1x0.5mm <sup>2</sup>	550mm	GND 9-15V Power input
1	red	1x0.5mm <sup>2</sup>		
8	white	1x0.5mm <sup>2</sup>	550mm	CAN1+ CAN1- K-Line GND K-Line
9	blue	1x0.5mm <sup>2</sup>		
10	black	1x0.5mm <sup>2</sup>		
11	blue	1x0.5mm <sup>2</sup>		

MX Series loggers 22 pins Deutsch connector standard harness



Tabella dati cavi terminati con connettori Binder 719 4 pin femmina

Pin Connettore Deutsch 22 pin	Colore cavo	Pin connettore di destinazione	Tipo di cavo	Lunghezza	Canale	Etichetta
1 2 3 4	Bianco Nero Rosso Blu	1 2 3 4	4x0.35mm <sup>2</sup>	380mm	Canale Analogico 5 GND V Battery V Reference	Ch.5
5 2 3 4	Bianco Nero Rosso Blu	1 2 3 4	4x0.35mm <sup>2</sup>	380mm	Canale Analogico 6 GND V Battery V Reference	Ch.6
6 7 8 9	Bianco Nero Rosso Blu	1 2 3 4	4x0.35mm <sup>2</sup>	400 mm	Canale Analogico 7 GND V Battery V Reference	Ch.7
10 7 8 9	Bianco Nero Rosso Blu	1 2 3 4	4x0.35mm <sup>2</sup>	400mm	Canale Analogico 8 GND V Battery V Reference	Ch.8
11 12 13	Bianco Nero Blu n.c.	1 2 3 4	3x0.35mm <sup>2</sup>	320mm	Speed 2 GND V Battery n.c.	Speed 2

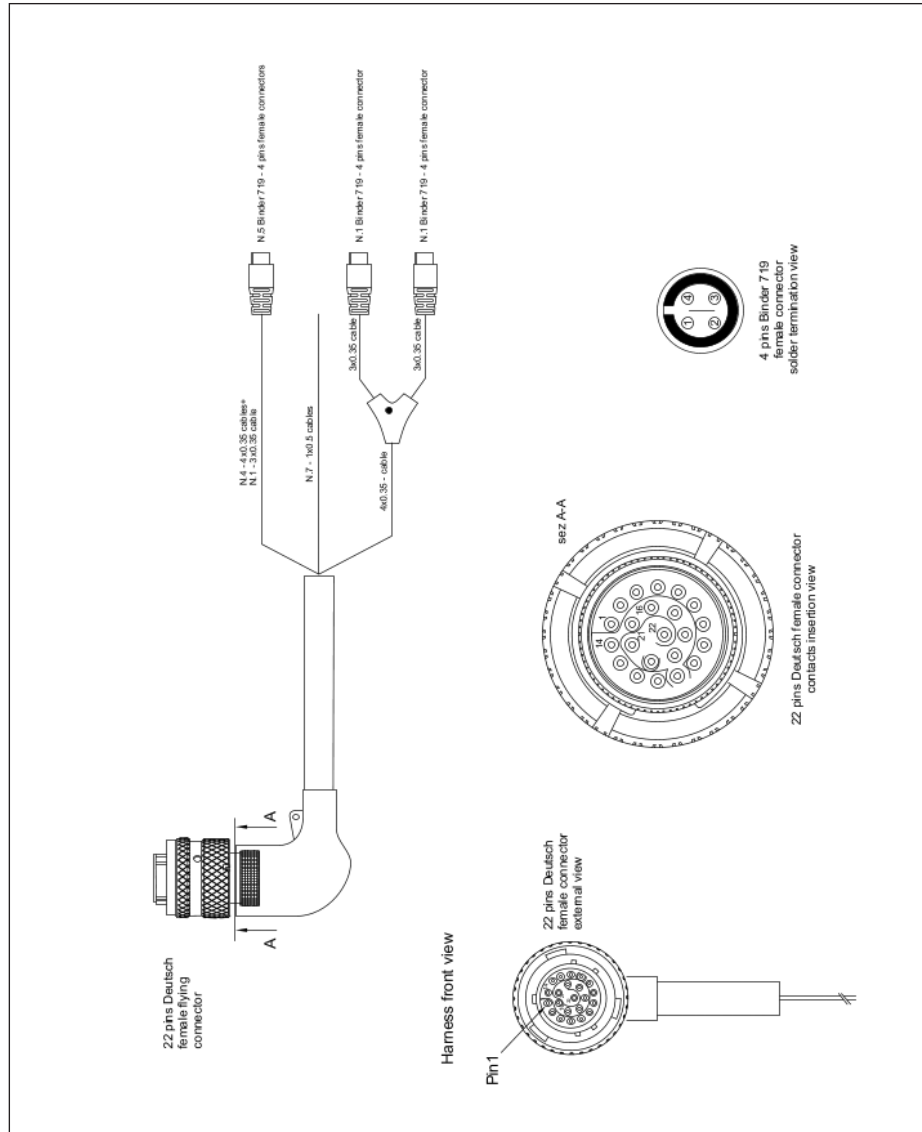

Tabella dati cavi non terminati

Pin Connettore Deutsch 22 pin	Colore cavo	Tipo di cavo	Lunghezza	Etichetta
19 20	bianco blu	1x0.5mm <sup>2</sup> 1x0.5mm <sup>2</sup>	550mm	Digital output 1 Digital output 2
17 18 16 21 22	bianco blu nero bianco blu	1x0.5mm <sup>2</sup> 1x0.5mm <sup>2</sup> 1x0.5mm <sup>2</sup> 1x0.5mm <sup>2</sup> 1x0.5mm <sup>2</sup>	550mm	CAN2+ CAN2- GND ECU RS232RX ECU RS232TX

## MX Series loggers USB cable

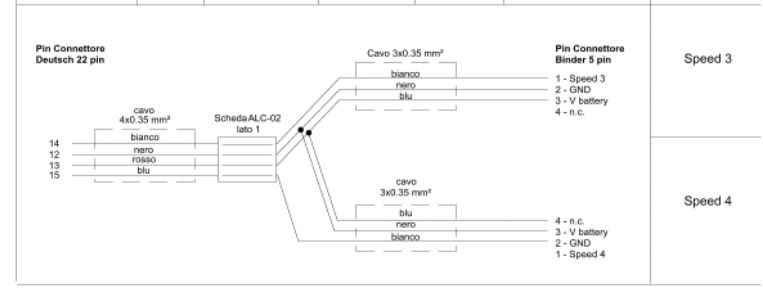
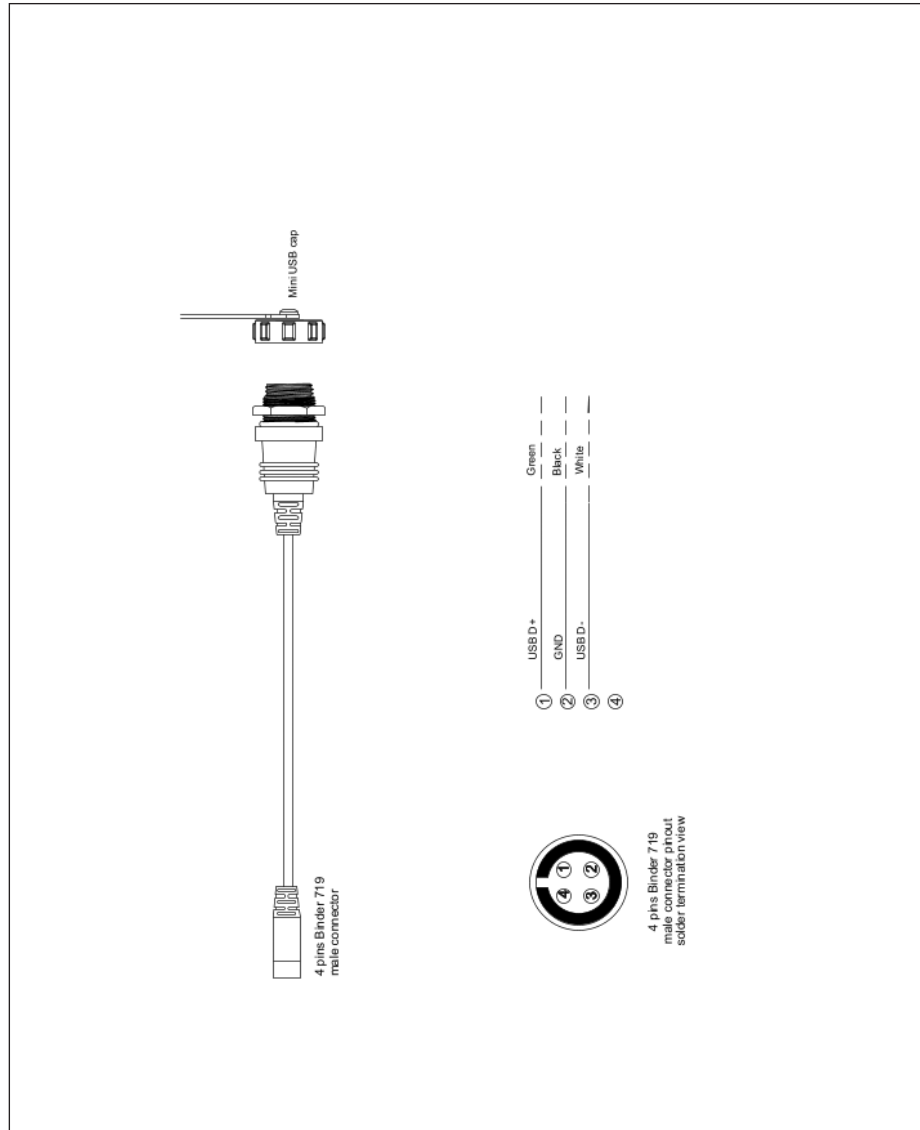

## MX Series mirror camera input

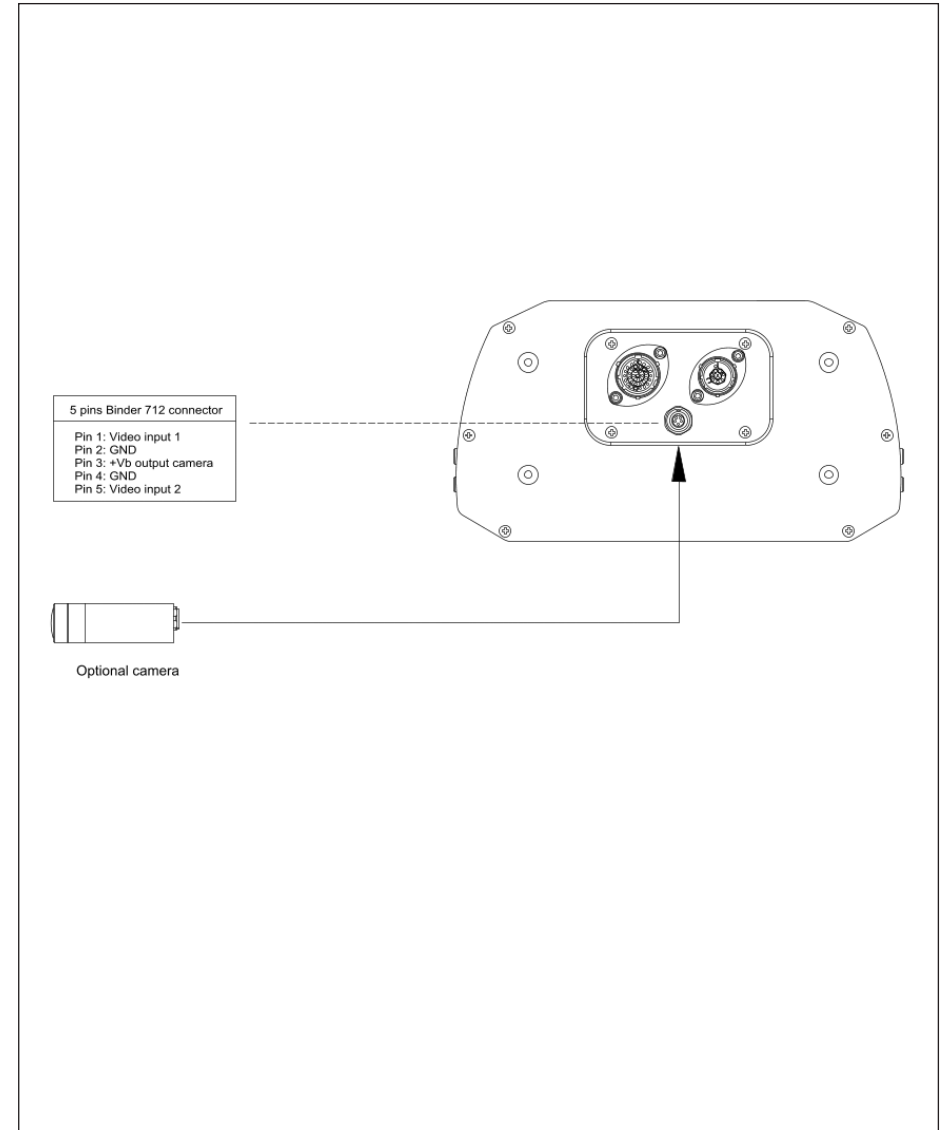

Mirror camera dimensions in mm [inches]

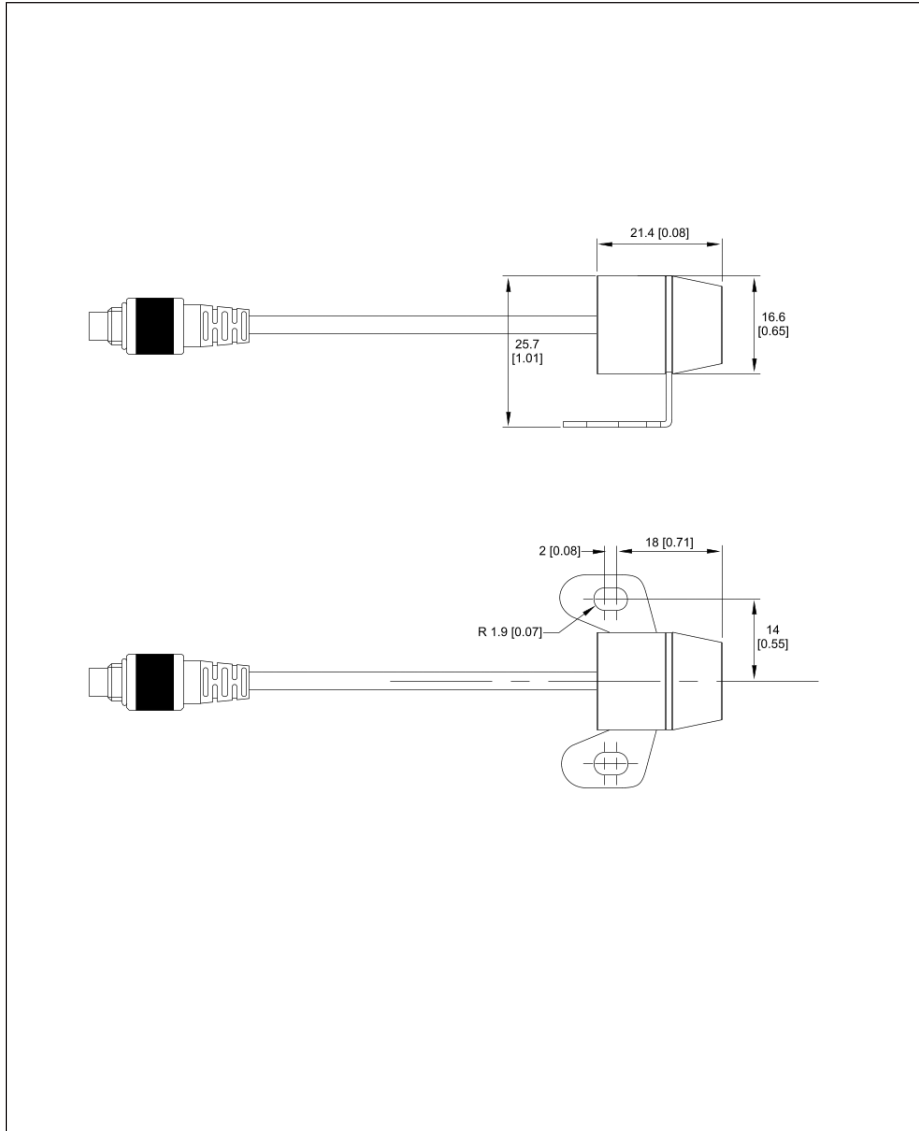

MX Series cable for single rear camera

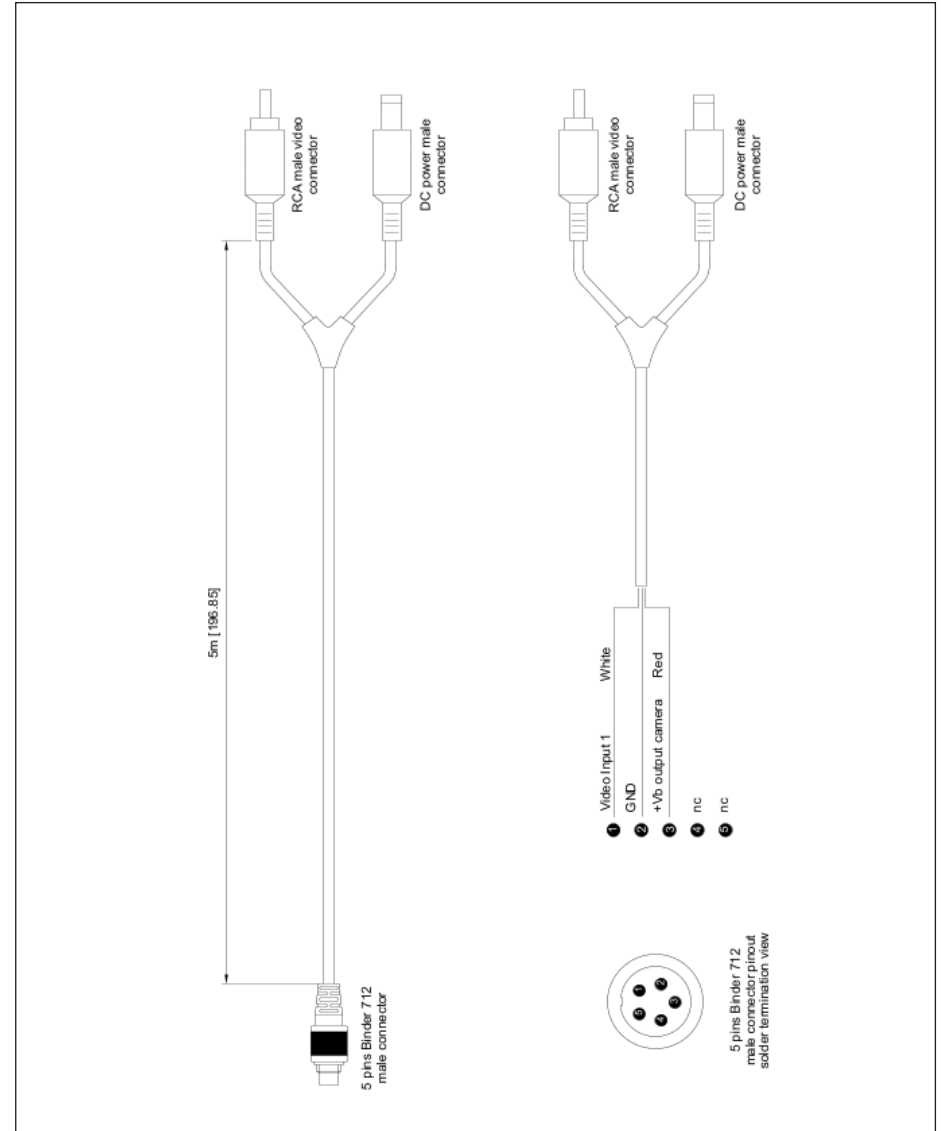



MX Series cable for n.2 rear cameras

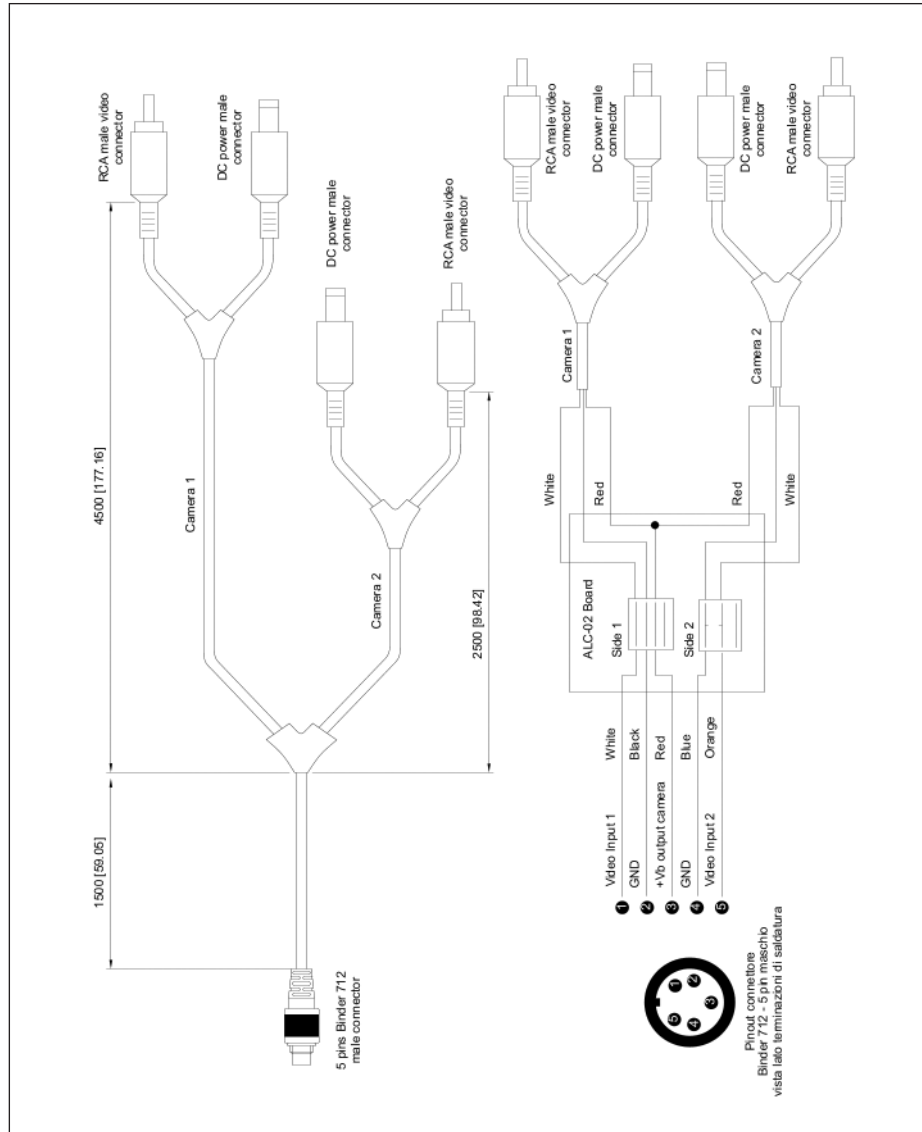

MX Series cable for single AiM mirror camera

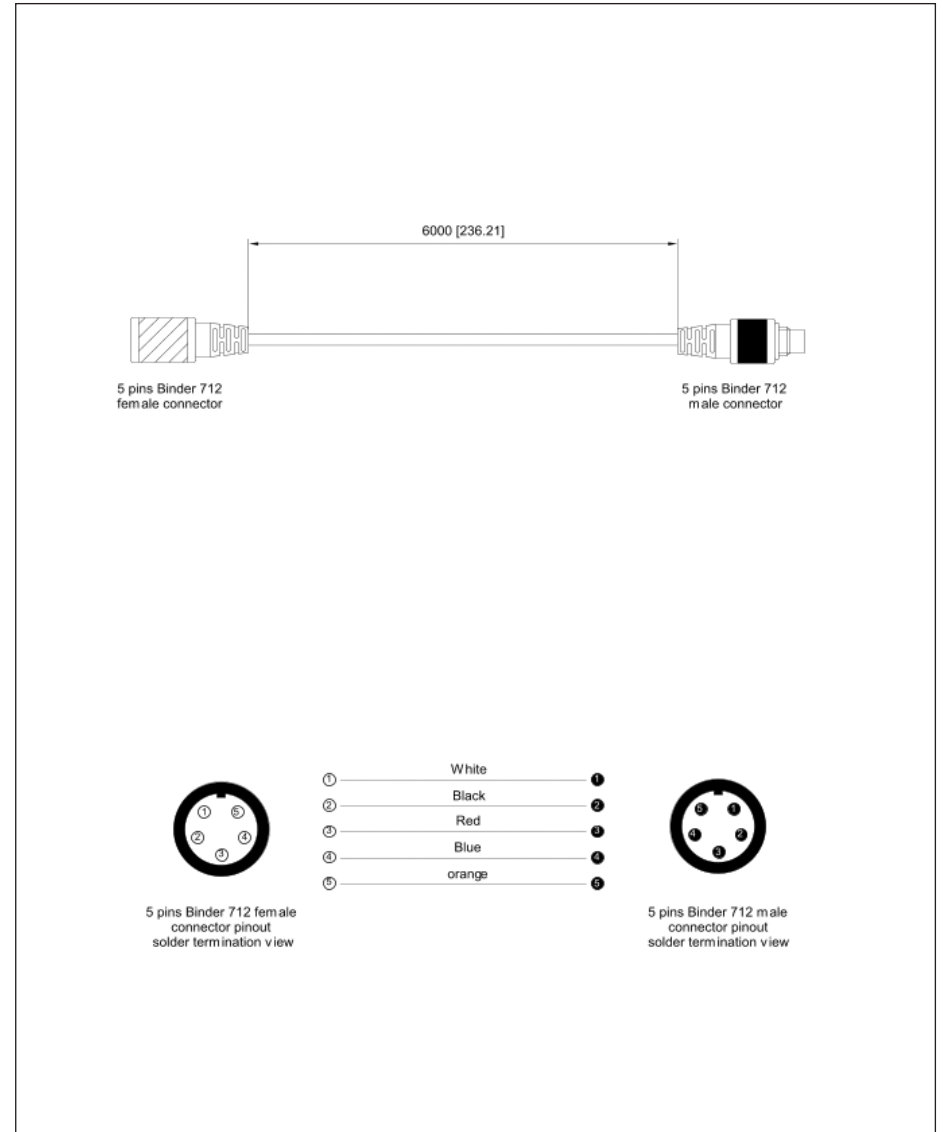

MX Series cable for n.2 AiM mirror cameras

