

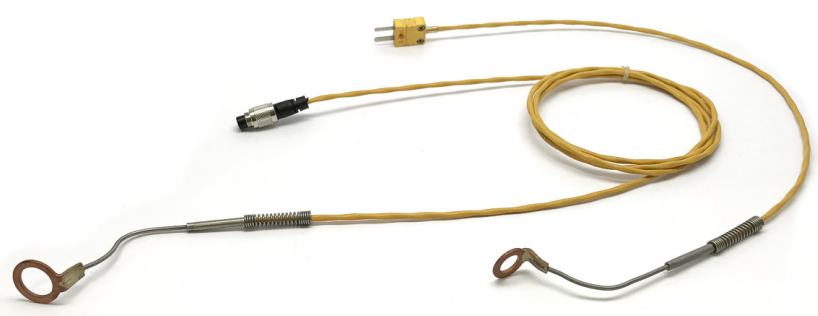

AiM Infotech

Cylinder Head Thermocouple

Release 1.03





1

Introduction

AiM devices can measure the cylinder head temperature of your kart using a sensor – thermocouple – placed between the spark plug and the cylinder head. This thermocouple is available with different diameters, cables and ending connectors as for the table below.

Part number	Thermocouple diameter	Cable length	Ending connector
X05SOT14A4517BML	14 mm	1500 mm	3 pins Binder 712 male
X05SOT14A4516MS	14 mm	400 mm	2 pins Mignon male
3CVSOT812	12 mm	1400 mm	3 pins Binder 712 male
3CVSOT8060	12 mm	400 mm	2 pins Mignon male
3CVSOT810	10 mm	1400 mm	3 pins Binder 712 male
3CVSOT8010	10 mm	400mm	2 pins Mignon male

All AiM thermocouples are K.type sensors.

2

Installation notes

The thermocouple features a turn in its lower part for an easier installation/uninstallation; it has to be placed between the spark plug and the cylinder head. To keep the sensor in contact with the cylinder head you need to remove the washer from the plug when installing the thermocouple.

While running the thermocouple cable along the kart chassis keep it as far as possible from other cables (like RPM or lap receiver ones) to minimize cable interferences.

Please note: before screwing the spark plug cable back ensure that the sensor is firmly fixed to the cylinder head and while screwing it minimize the thermocouple movements to avoid damages to the sensor.

The image below shows the sensor correctly installed.

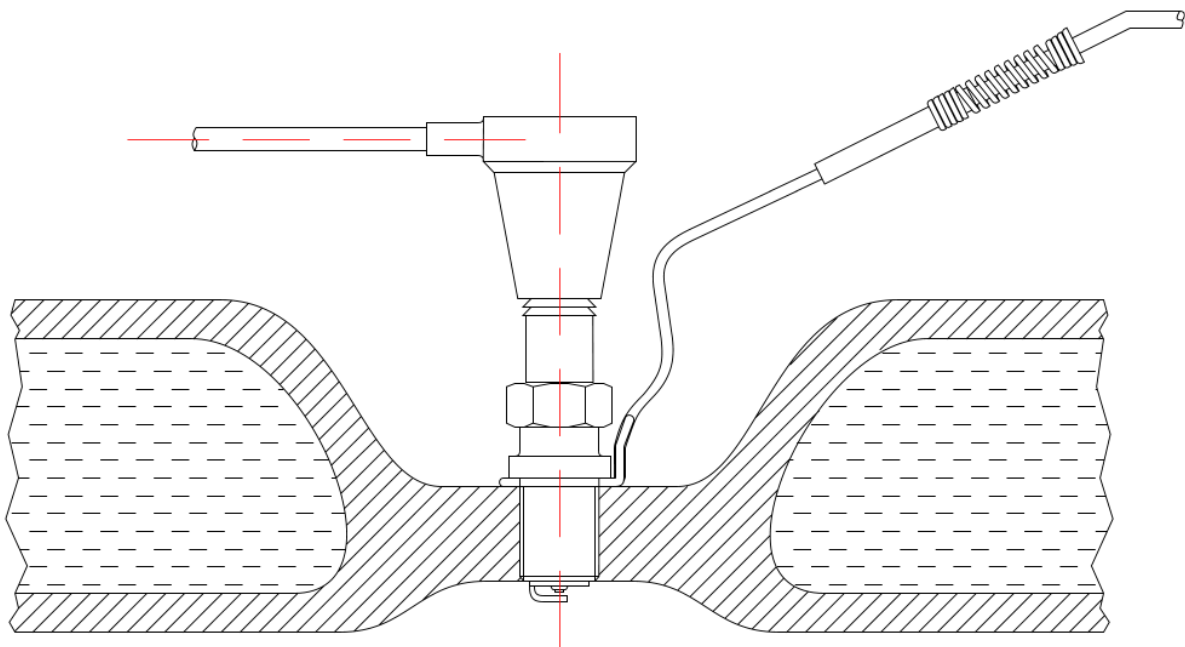

3

Dimensions, pinout and technical characteristics

The drawing below shows the thermocouple dimensions in its three versions in mm [inches].

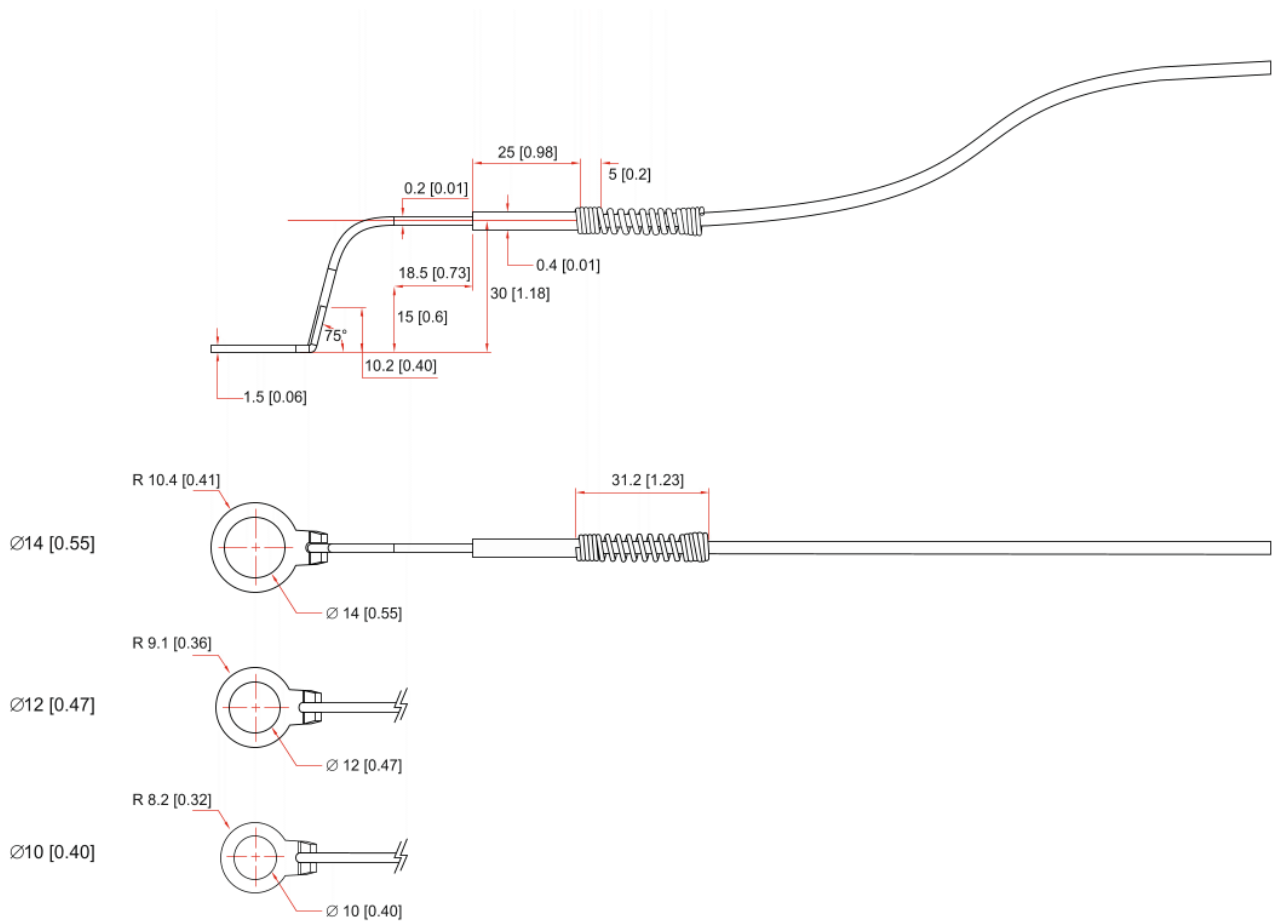

The thermocouple can be cabled with a 3 pins Binder 712 male connector or with a 2 pins Mignon male one. The images here below shows the connectors (3 pins Binder 712 male front view and 2 pins Mignon top view) and its pinout. Right of the drawings is connection table.

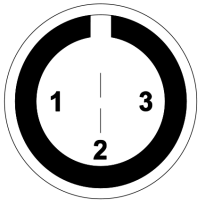

Binder connector pin	Function
1	0-50 mV temperature signal
2	GND
3	Not connected

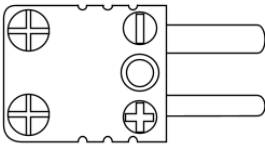

Mignon connector pin	Function
+	0-50 mV
-	GND

The cylinder head thermocouple **technical characteristics** are:

- Temperature working range: 0-300°C [32-572°F]
- Cable type: compensated

4

Extension cables

The cylinder head thermocouple is sold with different length cables and differently cabled. Standard length extension cables are available as optional; it is also possible to order specific length extension cables. Extension cables part numbers changes according to the cable length, the ending connector and to the device the sensor is to be connected to.

Extension for connection to:

- MyChron5
- TC Hub

Part numbers:

V03CCB05M – cable length: 50 cm

V03CCB10M – cable length: 100 cm

V03CCB15M – cable length: 150 cm

V03CCB20M – cable length: 200 cm...

up to

V03CCB60M – cable length: 600 cm

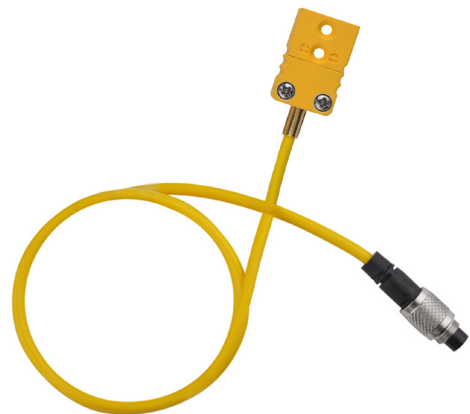

Extension for connection to:

- MyChron5 2T – harness with two thermocouples.

Part numbers:

V02.557.070

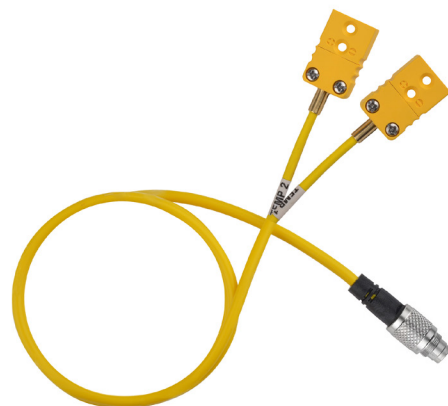

Extension for connection to:

- MyChron5 2T – harness with one thermocouple + one thermoresistor.

Part numbers:

V02.557.110



Extension for connection – through dedicated harness* – to:

- MXG/MXS
- MXL2
- MXL Strada/Pista/Pro05

Part numbers:

V02CCM05M – cable length: 50 cm

V02CCM10M – cable length: 100 cm

V02CCM15M – cable length: 150 cm

V02CCM20M – cable length: 200 cm...

up to

V02CCM45M – cable length: 450 cm



***Please note:** to connect the thermocouples to these AiM devices you need its dedicated harnesses:

- **V02573080:** MXL2/MXG/MXS harness for 22 pins connector with 1 thermocouple
- **V02573160:** MXL2/MXG/MXS harness for 22 pins connector with 2 thermocouples
- **V02573040:** MXL2/MXG/MXS harness for 37 pins connector with 1 thermocouple
- **V02573050:** MXL2/MXG/MXS harness for 37 pins connector with 2 thermocouples
- **V02586040:** EVO5 harness for 37 pins connector with 1 thermocouple
- **V02586050:** EVO5 harness for 37 pins connector with 2 thermocouples
- **V02554080:** MXL Strada/Pista harness with 1 thermocouple
- **V02554150:** MXL Strada/Pista harness with 2 thermocouples
- **V02554210:** MXL Pro05 harness for 37 pins connector with 2 thermocouples.

Mandatory extension cable for connection to:

- EVO4
- EVO4S

Part numbers:

V02PCB10MXG – cable length: 50 cm

V02PCB15MXG – cable length: 100 cm

V02PCB20MXG – cable length: 150 cm

V02PCB25MXG – cable length: 200 cm...

up to

V02PCB60MXG – cable length: 600 cm

