



SOLO 2 DL

User Manual
1.02



1 – Solo 2 DL in a few words	02
2 – What is in the kit?	04
3 – Installation, powering and accessories	06
4 – What is multiple configurations feature?	07
5 – At power on	07
6 – What you can do via keyboard	08
6.1 – Type of racing	09
6.2 – Track management	10
6.2.1 –Track creation with Solo 2 DL	11
6.3 – Backlight	15
6.4 – Wi-Fi	16
6.5 – System settings	16
6.5.1 – Configurations	17
6.5.2 – Unit of measure	17
6.5.3 – Date Time	18
6.5.4 – Language	18
6.5.5 – System info	18
7 – Solo 2 DL and the PC	19
7.1 – Connection to the PC	19
7.1.1 – Wi-Fi configuration	20
7.1.2 – Configuring Solo 2 DL as an access point (AP)	21
7.1.3 – Adding Solo 2 DL to an existing network	23
7.1.4 – Wi-Fi network settings	26
7.1.5 – The Internet connectivity	27
7.1.6 – Connection issues	28
7.1.7 – Working on Mac™ with virtualized Windows™	28
7.1.8 – Connected device visualization issues	30
7.2 – Configuration of Solo 2 DL	31
7.2.1 – Channels configuration	31
7.2.2 – ECU Connection and configuration	32
7.2.3 – CAN Expansions setting (LCU-One CAN only)	33
7.2.4 – Math Channels setting	34
7.2.5 – Parameters settings	35
7.2.6 – Led-Bar setting	36
7.2.7 – Display settings	38
7.2.8 – SmartyCam stream setting	40
7.3 – Transmitting multiple configurations	41
7.4 – Managing a track on Solo 2 DL with Race Studio 3	42
7.5 – ECU Driver builder	47
7.6 – The device window	48
7.6.1 – Online value forcing	49
8 – On the track	51
8.1 – Track page	51
8.2 – Other pages	52
9 – Data recall	52
9.1 – Data recall “Speed” mode	53
9.2 – Data recall “Performance” mode	54
10 – Data download	55
11 – Data Analysis	56
12 – New firmware upgrade	57
13 – RPM	58
13.1 – RPM from ECU	58
13.2 – RPM via a 5-50V square wave or coil (150-400V)	58
14 – Connection with SmartyCam and LCU-One	59
15 – Technical specifications and drawings	61

SOLO 2 DL

User Manual 1.02



1. Solo 2 DL in a few words

What is Solo 2 DL?

Solo 2 is the new AiM GPS log-timer (laptimer with internal data logger) that combines small dimensions, usability and logging capability.

Why Solo 2DL?

Because it features:

- ECU connection
- up to 8 configurable display pages.

This in addition to all Solo 2 features, to say:

- integrated GPS + Glonass receiver
- a huge tracks database that Solo 2 DL manages to automatically select the track you are racing on
- a powerful and comfortable Wi-Fi connection
- different type of races: speed and performance
- 10 RGB LEDs that clearly show if you are improving or not
- a huge amount of internal memory (four gigabytes) capable of recording a lot of

tests

What about ECU connection?

Solo 2 DL manages all the hardware ECU connections as well as all the communication lines: CAN, K-Line, RS232. Its huge database includes more than 1500 protocols you can load in your Solo 2 DL.

If the vehicle does not have an ECU?

In case your vehicle does not have an ECU, you can anyway connect Solo 2 DL to an RPM wave to synchronize RPM to the position on the track thanks to the RPM power cable.

Anything else?

Of course yes: Solo2 DL can receive up to 10 configurations



2. What is in the kit?

Solo2 DL kit includes:

- Solo2 DL
- Solo2 cable to choose among:
 - CAN/K-Line/External power cable with OBDII connector
 - CAN/RS232 External power cable
 - RPM/External power cable (if your vehicle has no ECU)
- Solo2 DL battery charger, available in four versions with Australian, UK, USA and European adaptor
- Solo2 DL mounting bracket with screws
- Race Studio 3 software installation CD
- AiM sticker and Racing Guide



3 Installation, powering and accessories

Thanks to its small dimensions and to the different accessories available for installation, Solo 2 DL can be installed on almost any kind of motorsport vehicle.

Solo 2 DL is powered by the vehicle battery and it switches off with the vehicle engine.

AiM provides different installation accessories, to say:

support for roll-bar: **X46KSTG00**



support for generic tube: **X46KSTP00**



support for suction cup: **X46KSVS00**



4 What is multiple configurations feature?

Solo 2 DL can receive up to 10 configurations, that need to be transmitted at one time, allowing you to select the one you need in each situation. This is also very helpful for a team manager, that can customize the configuration(s) for each racer.

Multiple configurations can be transmitted to Solo 2 DL and selected using Solo 2 DL keyboard as explained in paragraph 7.3

5 At power on

When switched on Solo 2 DL shows two pages: Solo2 DL Settings and satellite page.

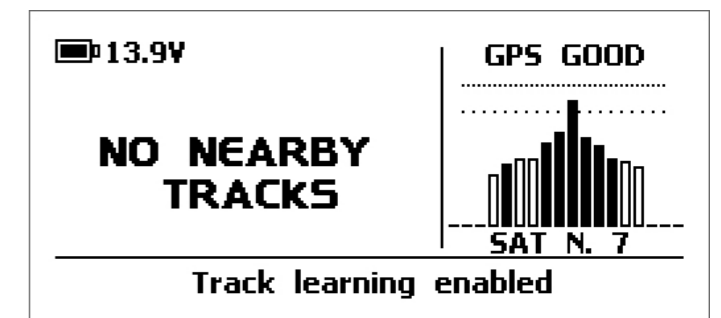
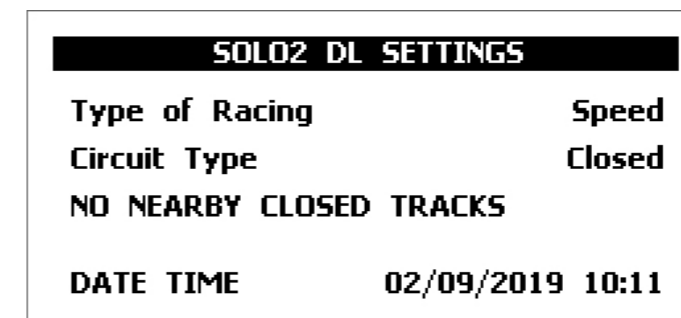

To optimize the display management, the keyboards disappears when not necessary. Please simply press one of the pushbuttons for making it show up again.

6 What you can do via keyboard

Solo 2 DL is mainly configurable using Race Studio 3 software but some functions are settable via keyboard as explained here on the right. Press "MENU" and this page shows up.

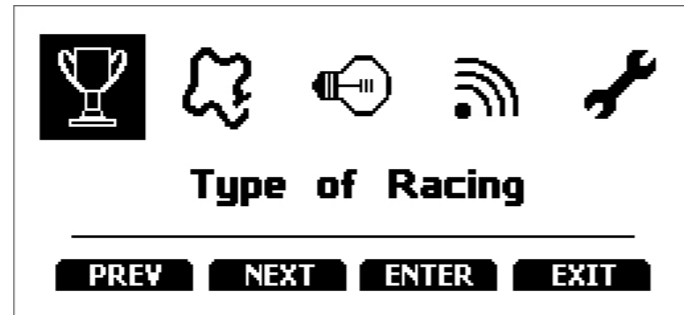

The icons are to manage:

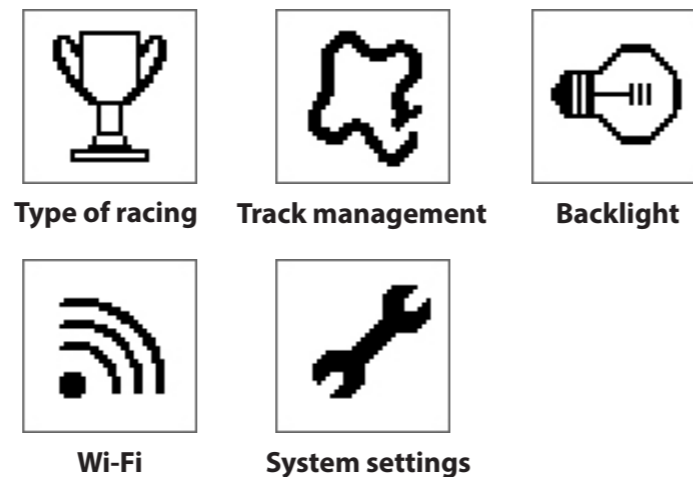

6.1 Type of racing

Solo 2 DL features two different type of races, each of them with different options:

- speed (left image below)
- performance (right image below)

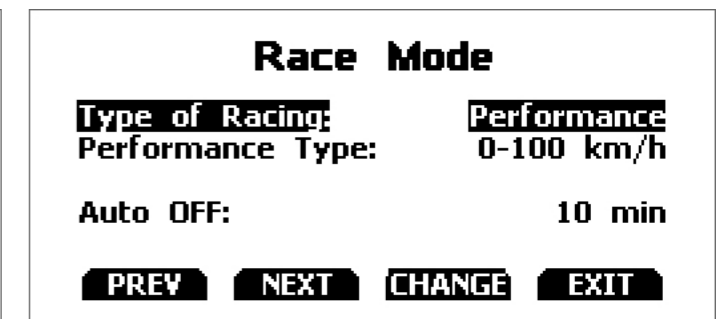

Speed racing

Solo 2 DL automatically selects the track in which you are performing. After having found the proper track, it may calculate show and set:

- Circuit type: closed or open
- Predictive Reference lap: the time at the end of the current lap is computed looking at the actual speed, compared with a reference lap. The reference lap can be:
 - the best lap of the test or
 - the best lap of today
- "Auto OFF": a time period of inactivity that switches your Solo 2 DL off. Available options are:
 - 10 min
 - 20 min
 - 30 min
- "Lap summary": at the end of the test Solo 2 DL shows lap summary page. See chapter 9 "Data Recall" chapter for further information about it. Available options are: enabled (default) or disabled.

Performance racing:

This racing mode shows you different performance options according to the measure unit you set in "System settings" -> "Unit of measure" menu:

- using **imperial** unit of measure (mph) the available performance options are:
 - 0-60 mph
 - 60-0 mph
 - 1/8 miles
 - 1/4 miles
- using **decimal** unit of measure (km/h) the available options are:
 - 0-100 km/h
 - 0-160 km/h
 - 100 m
 - 150 m
 - 400 m
 - 1000 m
- "Auto OFF": a time period of inactivity that switches your Solo 2 DL off. Available options are:
 - 10 min
 - 20 min
 - 30 min

6.2 Track management

Solo 2 DL built in GPS receiver is used for:

- Lap time calculation
- Speed calculation
- Predictive lap time calculation
- Position on the track in Analysis.

To calculate these data the system needs to know the Start/Finish line coordinates.

Solo 2 DL comes with a long list of the world main tracks, list that is constantly updated by our technicians and is downloaded on your PC when you run our Analysis software and an Internet connection is available.

Solo 2 DL provides two track selection modes: automatic and manual.

Automatic:

The system automatically recognizes the track you are running on, loads start/finish line and calculates lap times. This is the best mode in most cases.



Manual:

Allows you to manually select the track from the internal database. This mode is to be preferred when multiple track configurations are available nearby. In this case Solo 2 DL would anyway recognize the track but would need at least one complete track lap. To be ready from the first lap manual mode would be helpful.



Both track modes provide three track list type:

- nearest: shows only tracks in a 10 km distance with max 50 tracks shown
- all tracks: shows all tracks stored in the system in alphabetical order
- custom: shows only the tracks you have previously created (learning mode)

6.2.1 Track creation with Solo 2 DL

If you are running in a track NOT included in Solo 2 DL database you can create it. According to the circuit type you set in "Type of racing" (paragraph 6.1) you can create a closed (in automatic or in manual mode) or an open (in manual mode only) circuit.

Creating a closed circuit automatically

To create a closed circuit in automatic mode:

- type of racing is to be "Speed" (paragraph 6.1)
- circuit type is to be "Closed"



From Solo 2 DL main page press any key and the bottom keyboard shows up: press "TRACK"

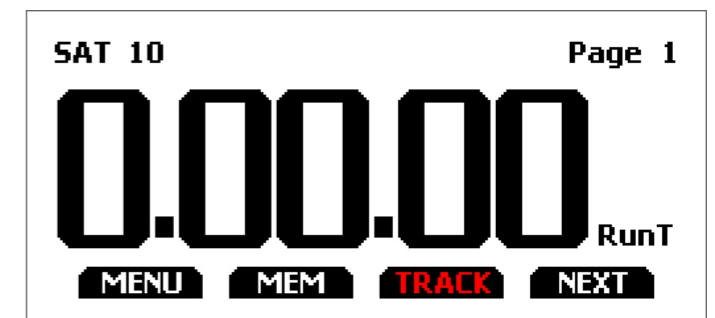

Press "CREATE".

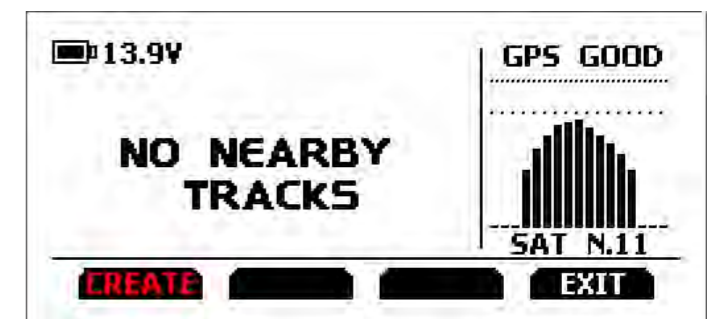

Select "AUTOMATIC CREATION" and press "ENABLE".

When GPS signal is good Solo 2 DL starts recording each track point. When it detects it is crossing the same point for the second time it defines a temporary start/finish line in order to show lap times.

Solo 2 automatically creates a track. As soon as the session is over the new track layout is displayed; start/finish line can be changed and a track name can be added using the device keyboard.

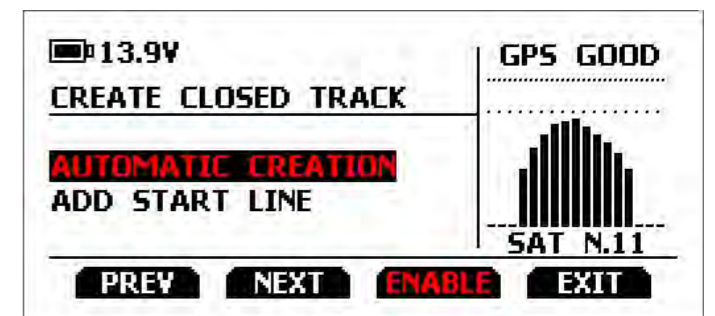

Creating a closed circuit manually

To create a closed circuit in manual mode:

- type of racing is to be "Speed" (paragraph 6.1)
- circuit type is to be "Closed"



From Solo 2 DL main page press any key and the bottom keyboard shows up: press "TRACK"

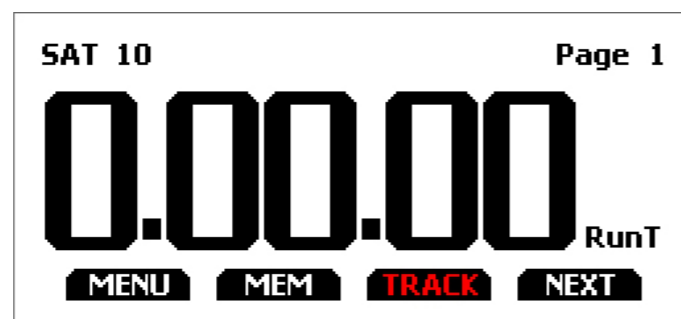

Press "CREATE".

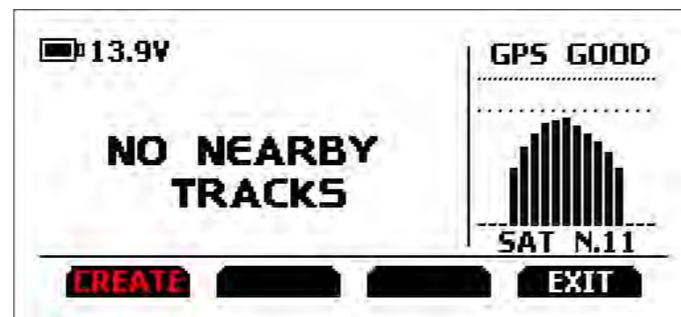

Select "ADD START LINE" and Press "ENABLE"

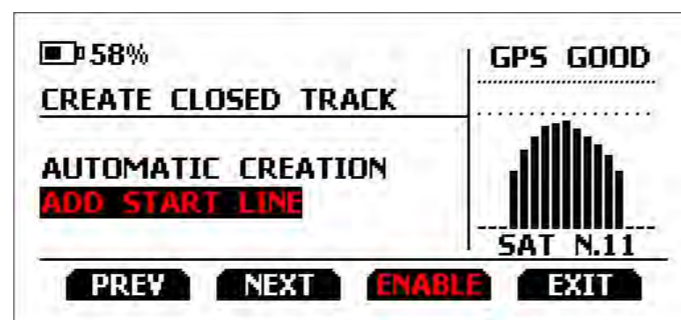

Go to the start/finish line and press "OK".

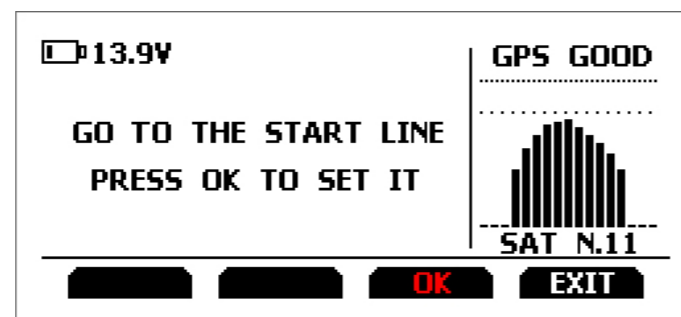

The track has been created.
Its name is track date and time

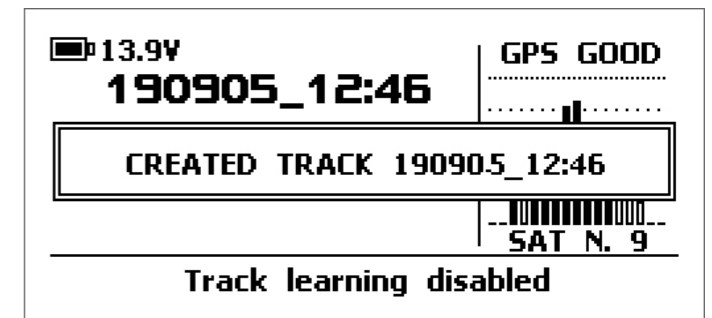

Creating an open circuit (only manually)

To create an open circuit:

- type of racing is to be "Speed" (paragraph 6.1)
- circuit type is to be "Open"



From Solo 2 DL main page press any key and the bottom keyboard shows up: press "TRACK"

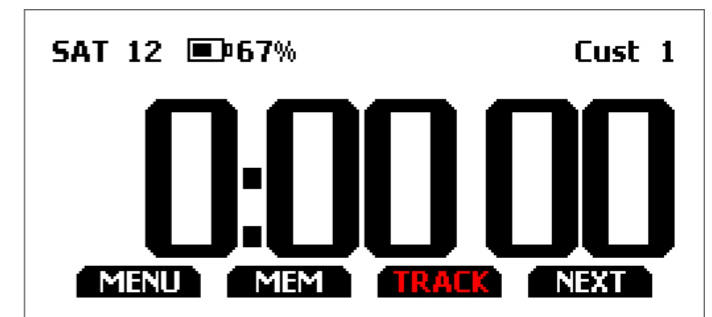

Press "CREATE".

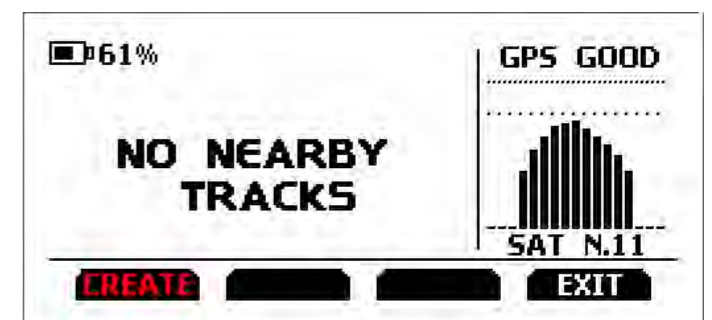

Select "ADD START/FINISH LINE" and Press "ENTER"



- Solo 2 DL allows the user to create a temporary track:
- "Yes": Solo 2 DL creates a track that will be available until the following Tuesday
 - "No": Solo 2 DL creates a track that will be saved in the device memory permanently

Ensure that GPS signal is "GOOD", go to the start line and press "OK"

To acquire the track shape press "YES".

Go through the track towards the finish line to set it.

Please note: Start and finish line distance has to be at least 10m. Once this distance reached the display of Solo 2 DL shows an additional bottom line and "OK" button shows up: press it.

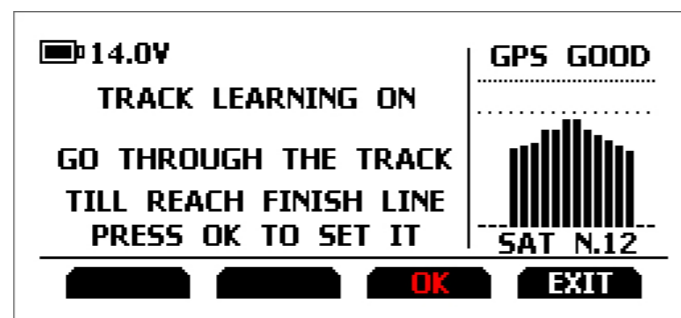
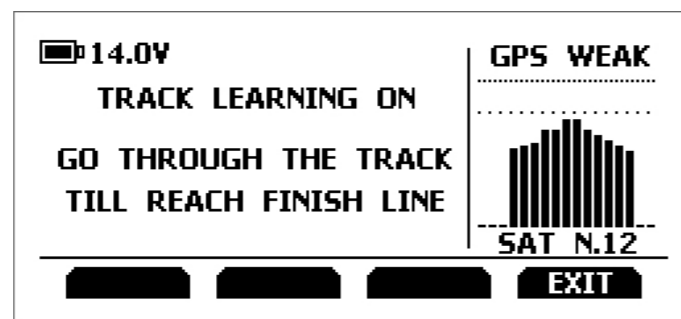
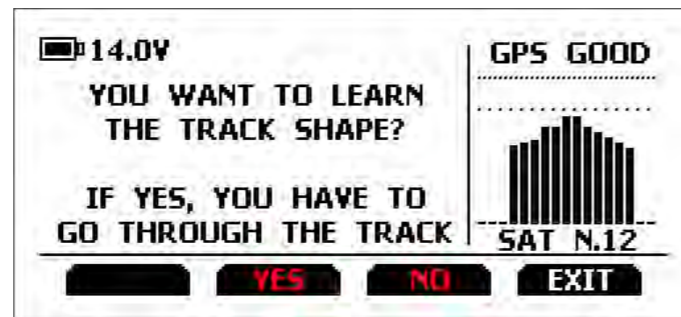
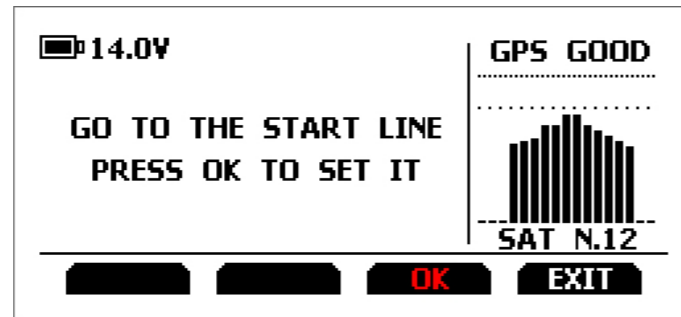
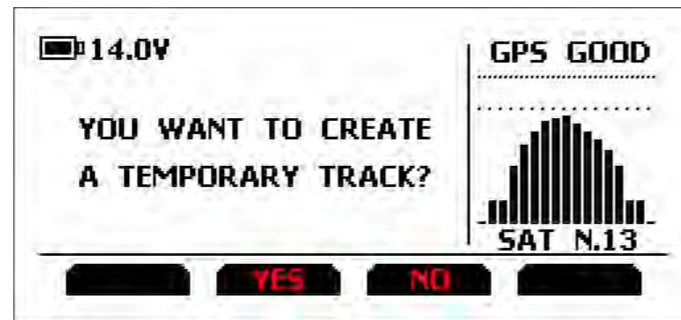

The track is created named as date and time of the creation.

The display shows its shape.

For further information about track creation with Solo 2 DL refer to FAQ section, Solo 2, Lap Functions of www.aim-sportline.com.

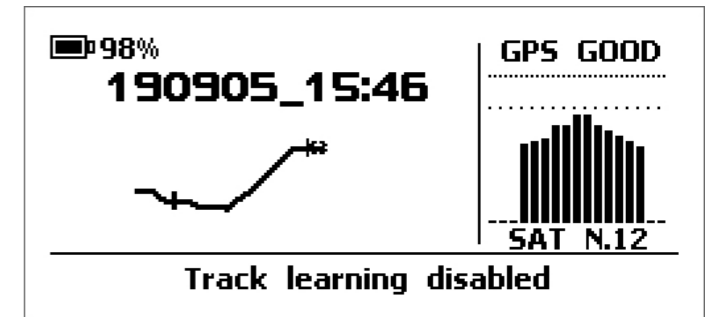
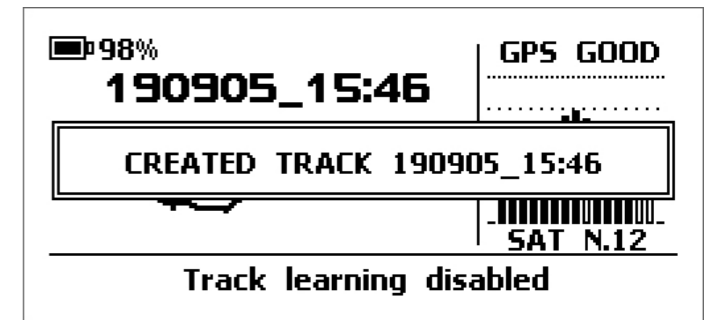

6.3 Backlight

You can set Solo 2 DL backlight as "ON" (default setting) or "OFF" as well as choose among eight different colours: white, purple, red, green, yellow, blue, magenta and cyan.



6.4 Wi-Fi



Here you can manage Wi-Fi as well as reset its configuration. **Wi-Fi modes** are:

- ON
- Auto: switches Wi-Fi on when the vehicle is stopped and automatically switches it off when Solo 2 DL starts recording (according to "Memo" trigger setting)
- OFF

"Wi-Fi Reset CFG" allows you to reset Wi-Fi configuration and is very useful if you do not remember Wi-Fi password.

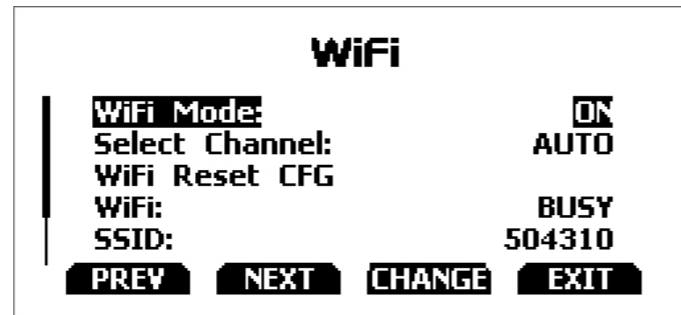

6.5 System settings



Selecting this icon you enter this page:

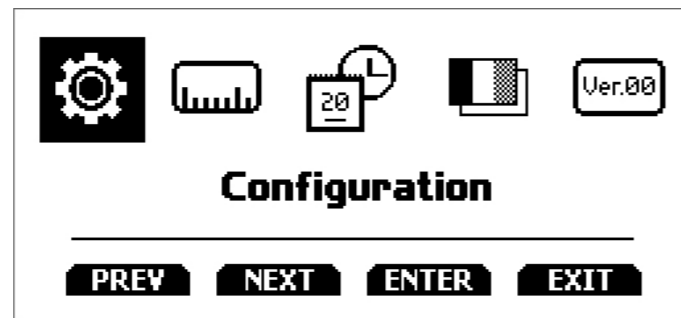

6.5.1 Configurations



Here you can manage Solo 2 DL wake up mode as well as its configuration(s) as shown here below on the left. In case you transmitted multiple configurations (max allowed number of configuration is 10 and they have to be transmitted at the same time – see paragraph 7.3) this page shows the one currently in use. To change it:

- press "CHANGE"
- use "PREV" and "NEXT" button to select the configuration to set and press "EXIT" (image here below on the right)

Wake up from ECU (signal). Use "Change" button to change this setting.

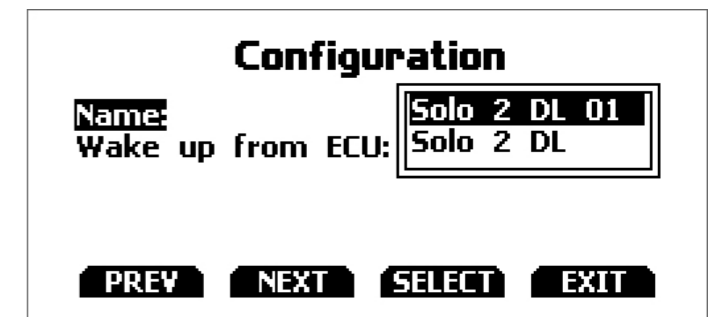

- The system asks for confirmation: press "CHANGE"

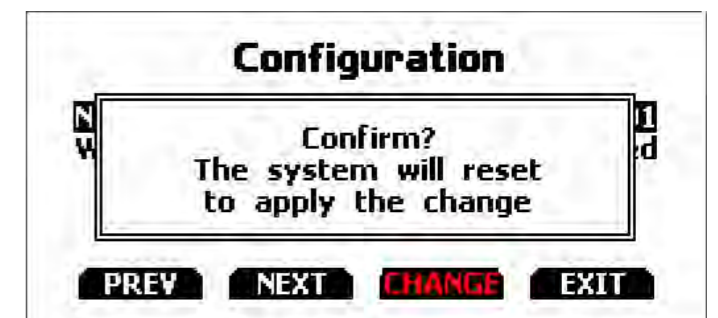

6.5.2 Unit of measure



You can set the measure unit of:

- speed: km/h or mph; please remember that the measure unit you set here will make you see different options in "Type of Race" menu if selecting "Performance" type (refer to paragraph 6.1 for further information)
- temperature: Celsius/Fahrenheit
- pressure: bar/PSI



6.5.3 Date Time



Here you can set the time zone of your Solo 2 DL as well as enable/disable "Daylight Saving time" option. Time zone is always set manually. Date and time can be shown in different format.

Use "ENTER" button to enter and set options and "CHANGE" button to enable/disable "Daylight Saving Time" option.

Time is automatically synchronized as Solo 2 DL receives the GPS signal.

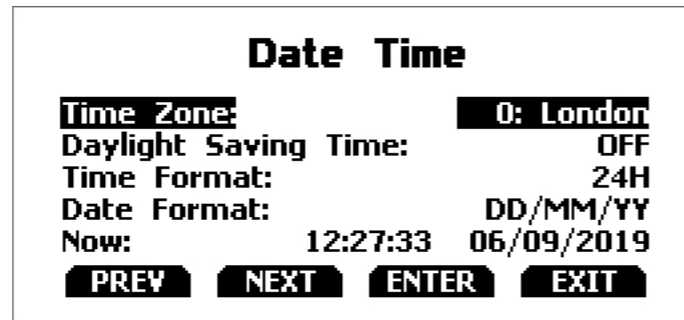

6.5.4 Language



You can set Solo 2 DL language. Default setting is English. At present available languages are (in this order):

- English
- Italian
- German
- Spanish
- French
- Dutch
- Danish
- Portuguese
- Japanese
- Czech

6.5.5 System info



This page shows serial number, firmware and boot version as well as hardware revision of your Solo 2 DL.

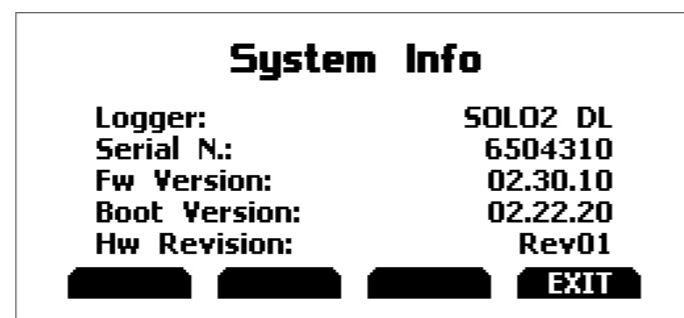

7 Solo 2 DL and the PC

Using AiM Race Studio 3 software you can configure Solo 2 DL, manage its tracks as well as check other device functions using the device window.

7.1 Connection to the PC

Solo 2 DL can be connected to the PC only via Wi-Fi. To do it:

- check that Solo 2 DL Wi-Fi is set on "AUTO" or on "ON"
- read your Solo 2 DL name – mid of Solo 2 DL home page bottom line – or look for it in "System Information" page.

- Click Race Studio3 Wi-Fi icon and select your Solo 2 DL

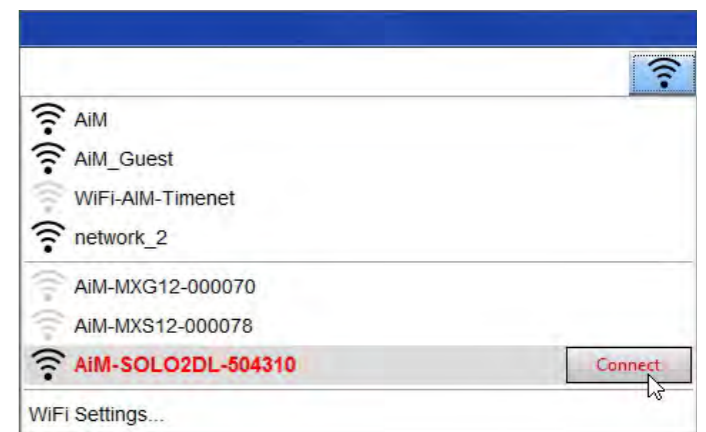

7.1.1 Wi-Fi configuration

Solo 2 DL configuration can be made only using Race Studio 3 software. Two possible Wi-Fi modes are available.

1 – As an access point (AP – default)

This is the ideal configuration if you have one only device and one only computer. In this situation your Solo 2 DL creates a Wi-Fi network and works as an Access Point you can connect your PC to.

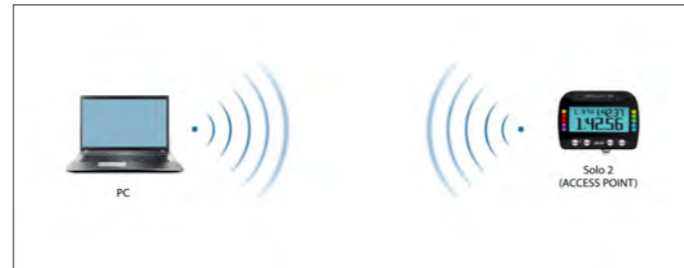

2 – Existing network (to connect to an existing Wi-Fi network – WLAN)

This mode is complex and implies an external access point (AP) but it is also more flexible and powerful because allows you to communicate with more than one device and with more than one computer in the same network. Solo 2 DL and the PC must connect to an existing Wi-Fi network made by a device that works as an external access point.

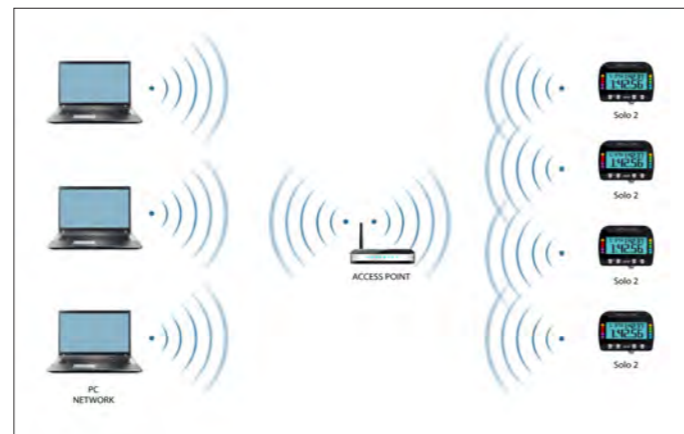

When working in WLAN mode Solo 2 DL has two available security levels:

- network authentication: network password
- device authentication: Solo 2 DL password

Both levels allow you to use different strategies. A PC in WLAN, for example, can see several AiM devices but can communicate only with those he knows the password of.

If you forget the password you can reset Wi-Fi configuration from Solo 2 DL menu as explained before (see paragraph 6.4)

7.1.2 Configuring Solo 2 DL as an access point (AP)

This is Solo 2 DL default configuration and is the easiest and most direct connection mode, ideal if you want to communicate with one Solo 2 DL using one PC. It is free and so completely accessible by anyone.

Please set an access password as soon as possible. To establish a Wi-Fi connection:

- ensure that the Wi-Fi is enabled
- read your Solo 2 DL Name

- run Race Studio 3
- click Wi-Fi icon and select your device
- in a few seconds the connection is established

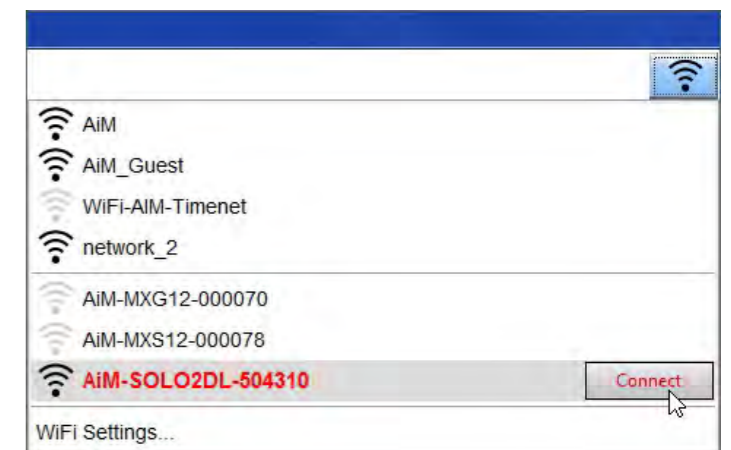
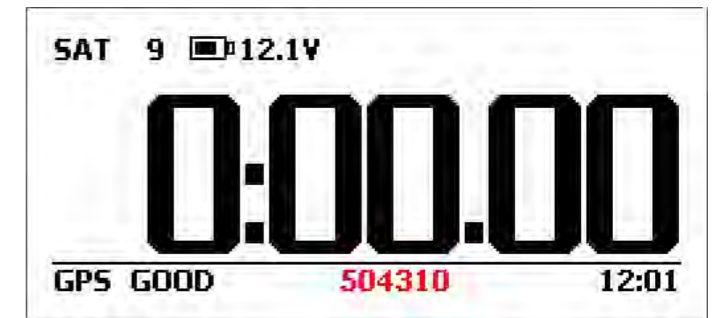

To set other parameters create a unique password to protect your device/your network. With a password the communication is safe and encrypted using WPA2-PSK standard.

Characters allowed in the password are all letters, also capital, all digits and these characters: '+- _() [] \$%&!/?^#@*\\"=~/:;/%"

"Space" type can be used if it is not the first one because this could cause incomprehension in some Windows™ versions.

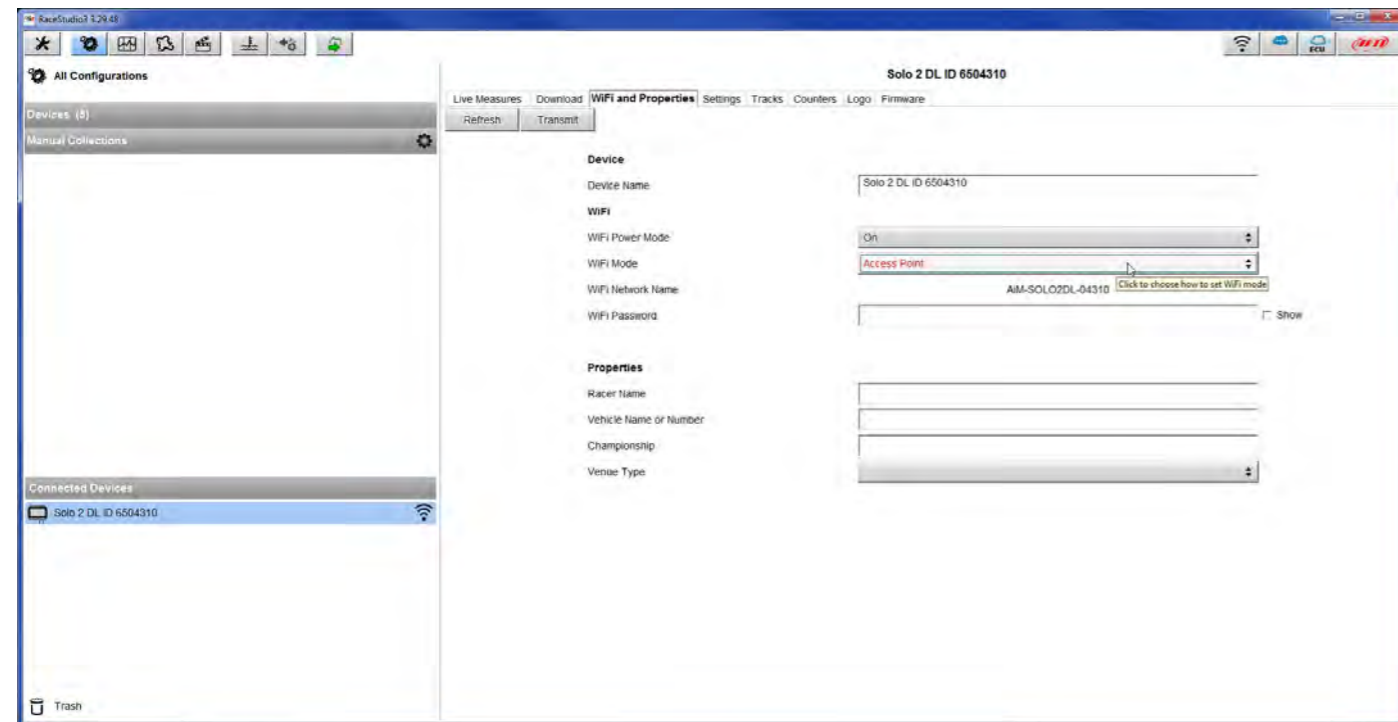

This AP or SSID name is unique for your device. An example of name is: "AiM-Solo2DL-00103" where:

- "AiM" is the prefix of all AiM devices
- "Solo2DL" is the device identifier
- "04310" is your device serial number assigned by the factory.

To make your device more recognizable you can add a name to the SSID. The limit is of eight characters. Allowed characters are all letters, capital too, all digits and these characters: '+ - _ () [] {} !.

"Space" type can be used provided that it is not the first one because it can cause incomprehension in some Windows™ versions.

If, for example you add the driver's name, Tom Wolf, the network name (SSID) becomes: "AiM-Solo2DL-04310-TomWolf"

Once all parameters set click "Transmit". Solo 2 DL reboots and is configured with the new parameters. If Solo 2 DL is protected by a password, as recommended, Race Studio 3 will ask that password to authenticate.

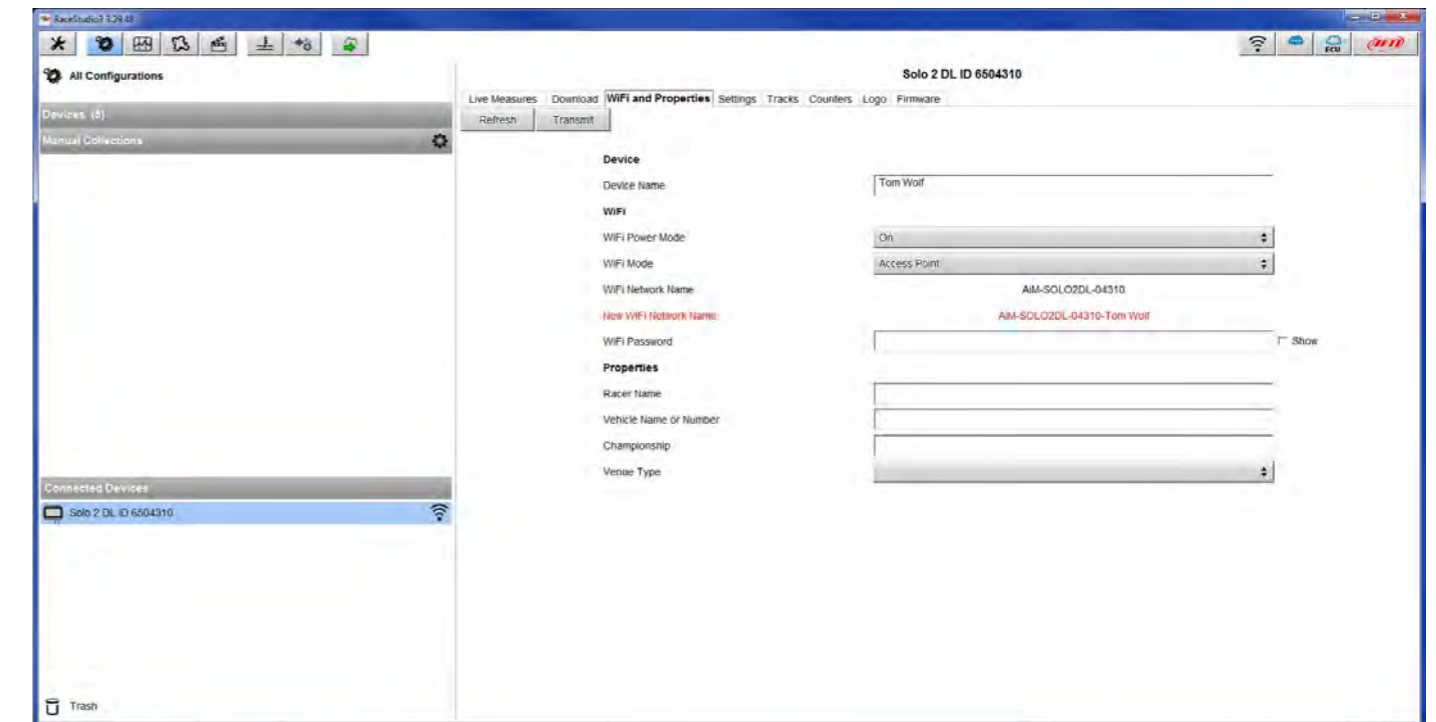

Please Note: the same Wi-Fi connection can be created with the operative system tool. Once the device has been authenticated in the Wi-Fi network you can communicate with it using Race Studio 3.

7.1.3 Adding Solo 2 DL to an existing network

This situation is ideal for a team with multiple drivers and staff members and is desired to communicate with one or more AiM devices using the same PC network. Each Solo 2 DL can have its password that adds another security and privacy level to the network.

Network"; fill in network name, network password and device password.

Transmit the network settings to your device clicking "Transmit": your device reboots and joins that network.

Race Studio 3 will show all Solo 2 DL connected to the same network under "Connected devices" label, bottom left of the software page: click your device.

Please note: the only admitted password are those following WPA2-PSK standard.

Enter "Wi-Fi and properties" tab and set it on "Existing

Here below you see a device "Solo2 DL-04310" that switched from Access Point to Existing Network. Network name is "network_2" and does not work with free access because is protected by a password.

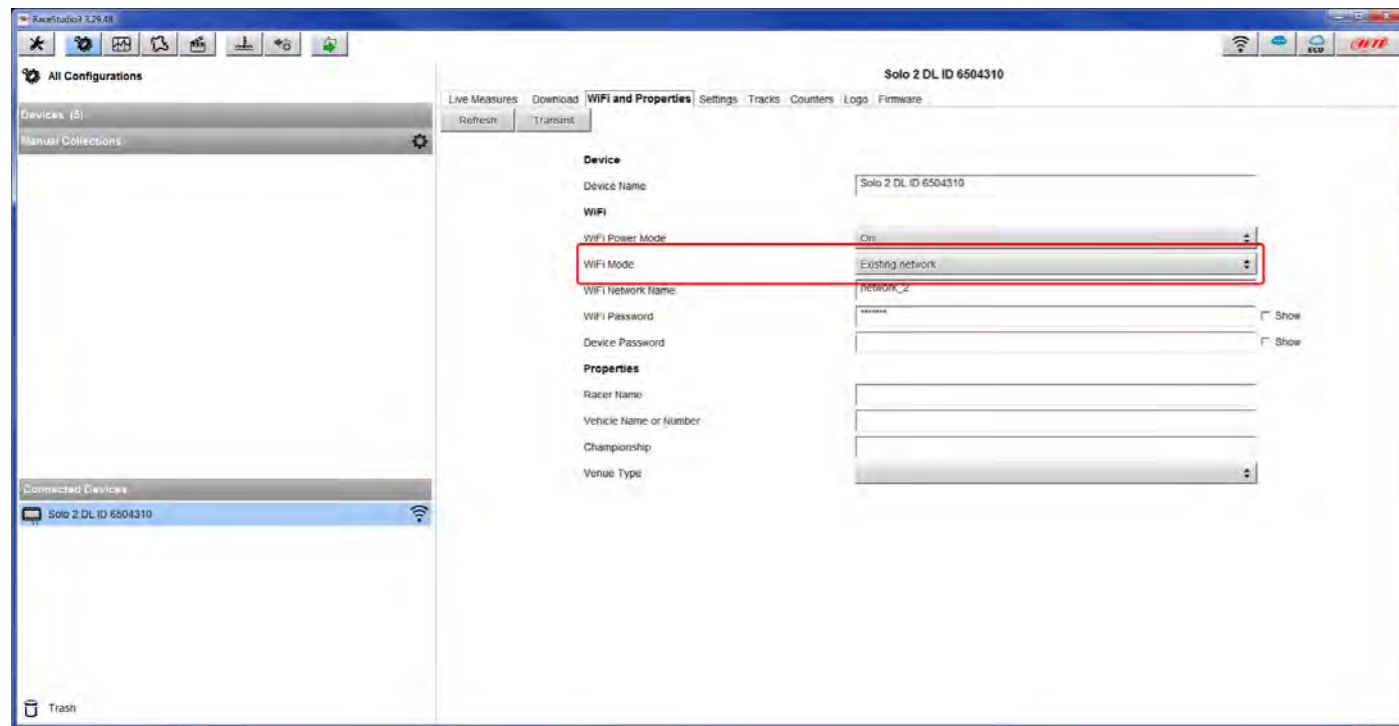

To obtain connectivity on the device the PC has to be authenticated to the same network as shown here below.

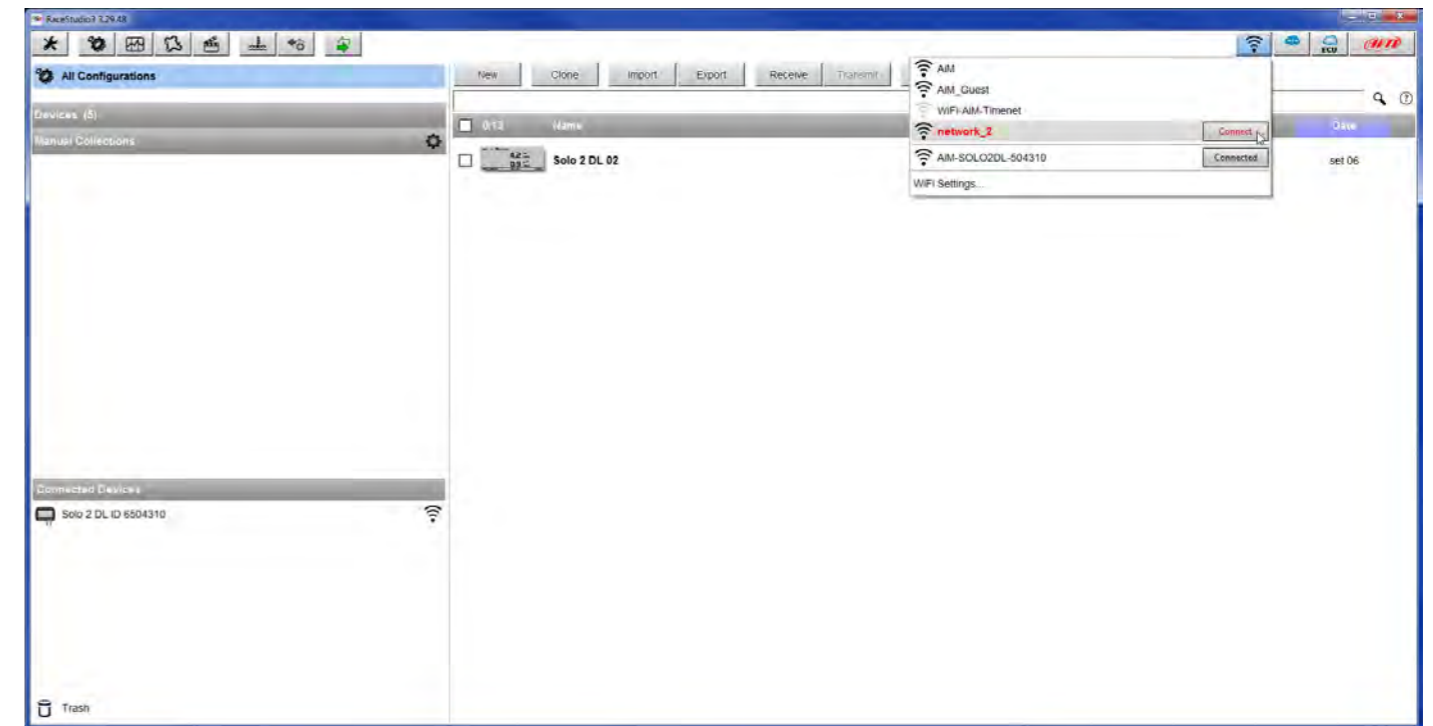

When the PC is authenticated to the network called "network_2" it can see all devices you configured to access the same network. In the image below three AiM devices are connected to the same "AiM" WLAN.

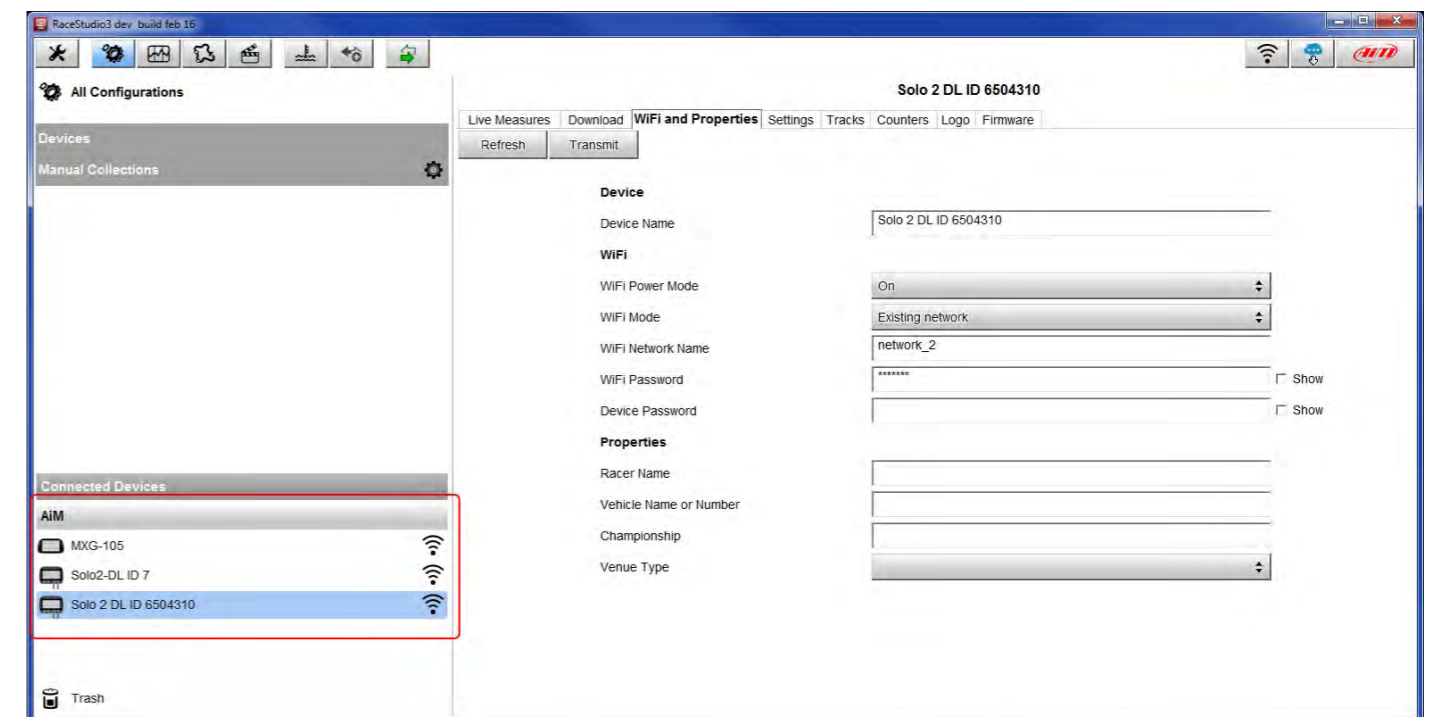

7.1.4 Wi-Fi network settings

In this chapter you find a short description of how to configure a WLAN including AiM devices and a PC. Here below is an example of configuration.

ROUTER SETTINGS

Use this section to configure the internal network settings of your router. The IP Address that is configured here is the IP Address that you use to access the Web-based management interface. If you change the IP Address here, you may need to adjust your PC's network settings to access the network again.

Router IP Address :

Subnet Mask :

Device Name :

Local Domain Name : (optional)

Enable DNS Relay :

DHCP SERVER SETTINGS

Use this section to configure the built-in DHCP Server to assign IP addresses to the computers on your network.

Enable DHCP Server :

DHCP IP Address Range : to

DHCP Lease Time : (minutes)

Always Broadcast : (compatibility for some DHCP Clients)

NetBIOS announcement :

Learn NetBIOS from WAN :

NetBIOS Scope : (optional)

NetBIOS node type : Broadcast only (use when no WINS servers configured)
 Point-to-Point (no broadcast)
 Mixed-mode (Broadcast then Point-to-Point)
 Hybrid (Point-to-Point then Broadcast)

Primary WINS IP Address :

Secondary WINS IP Address :

For better network performances, we suggest the use of a network device equipped with a DHCP server and using 3x3 MIMO technology like, for example a Linksys AS3200.

To maximize the bandwidth, you should not allow the Internet on this WLAN; this means the DHCP server should be configured without any DNS address nor gateway by default.

The parameters for the device network configuration in this example are:

■ **Wireless network name: Network_2**

It means that the WLAN network name is "Network_2." A PC has to be authenticated in this network to interact with any AiM device of this network.

■ **Gateway address: 192.168.0.1**

primary DNS server: 0.0.0.0
 secondary DNS server: 0.0.0.0
 (These settings prevent Internet connectivity on this WLAN.)

■ **Subnet mask: 255.255.255.248**

Enable DHCP server: yes
 DHCP IP address range: 192.168.0.2 to 192.168.0.6

These settings enable a DHCP server running on this WLAN and provide an IP address in a 2-6 range. This means that this network allows 5 network hosts.

The number of devices on a WLAN network depends on the subnet mask. Here below you see typical examples of network masks and IP addresses range.

The configuration in bold is the one we suggest (if a greater number of devices is not needed), being the one that makes it easier and quicker for Race Studio 3 the identification of the devices in the network.

Subnet mask:	IP address range:	Number of devices:
255.255.255.0	192.168.0.1 – 254	254
255.255.255.128	192.168.0.1 – 126	126
255.255.255.192	192.168.0.1 – 62	62
255.255.255.224	192.168.0.1 – 30	30
255.255.255.240	192.168.0.1 – 14	14
255.255.255.248	192.168.0.1 – 6	6

7.1.5 The Internet connectivity

For an optimal speed of your AiM device(s) we recommend not to allow the Internet on the same network and to set the WLAN in the same way.

You can of course allow the Internet access on your network but this would degrade the communication. This slightly slower speed can be suitable for your needs but you can also have a second Wi-Fi connection using an additional hardware (NIC).

This configuration would provide an optimal speed of the data network of your AiM device(s) and at the same time would provide an internet connectivity with the second NIC.

7.1.6 Connection issues

It can occur that Solo 2 DL is correctly connected to Race Studio 3 via Wi-Fi but the user interface does not show it. This may be because Wi-Fi port setting is set with a static IP.

To switch it to dynamic (DHCP):

- open "Network and sharing centre" in the Windows™ research engine
- right click on the Wi-Fi connection and a panel shows up
- select "Properties" option
- double click on "Internet Protocol version 4 (TCP/IPv4)"
- verify that option "Obtain an IP address" is active

For further information refer to FAQ section, Wi-Fi of www.aim-sportline.com.

7.1.7 Working on Mac™ with virtualized Windows™

Race Studio 3 only works on Windows™ operative systems; Mac users can use a virtualized Windows™ machine. The main problem is that the host OS (Mac) must share its Wi-Fi interface with the virtualized operative system (Windows) as Ethernet interface and not as Wi-Fi interface.

Configuring Parallels™

Select "Menu -> Configure...".

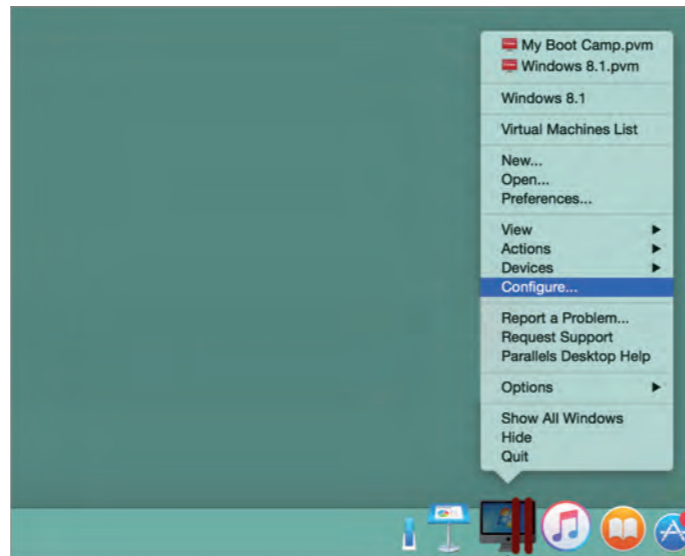

Press "Hardware" – top on the page that shows up – and select "Network" in the drop-down menu on the left. Right on the configuration panel set "Type" field on "Wi-Fi". Then select the device

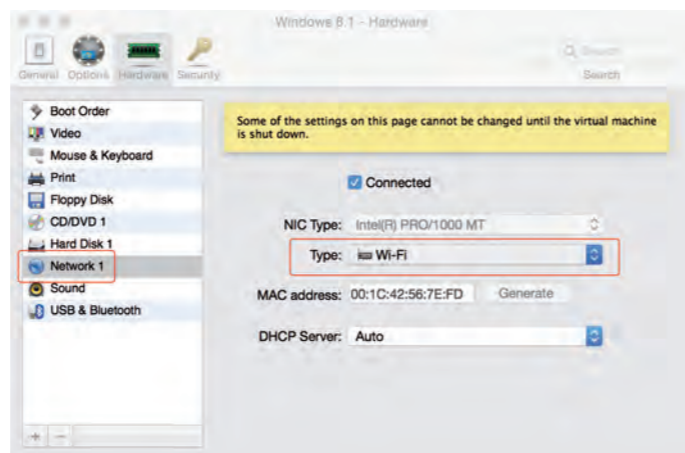

To ensure that the communication works select "Open Network preferences..." menu".



Verify that the status in the window that shows up is "Connected" and that the IP address associated is, for example, 10.0.0.10 (could be 10.0.0.11, 10.0.0.12, or generically 10.0.0.x).

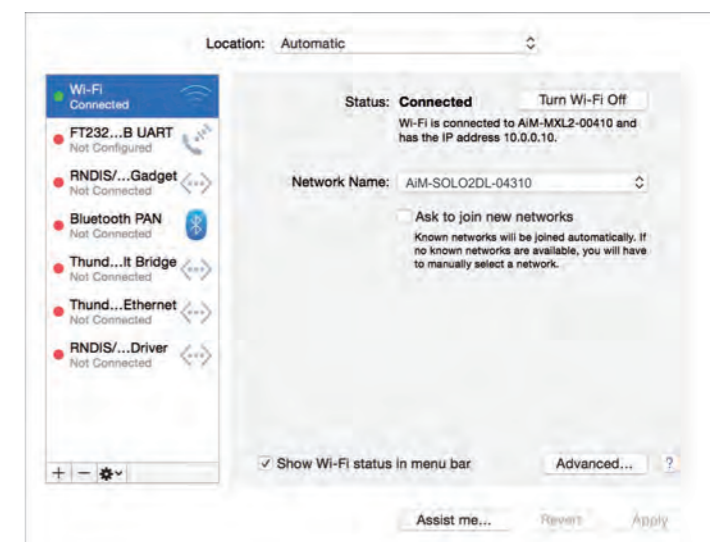

To enable Race Studio 3 correctly working on a Mac with virtualized WindowsTM.

- press Wi-Fi icon
- select "Wi-Fi Settings" icon

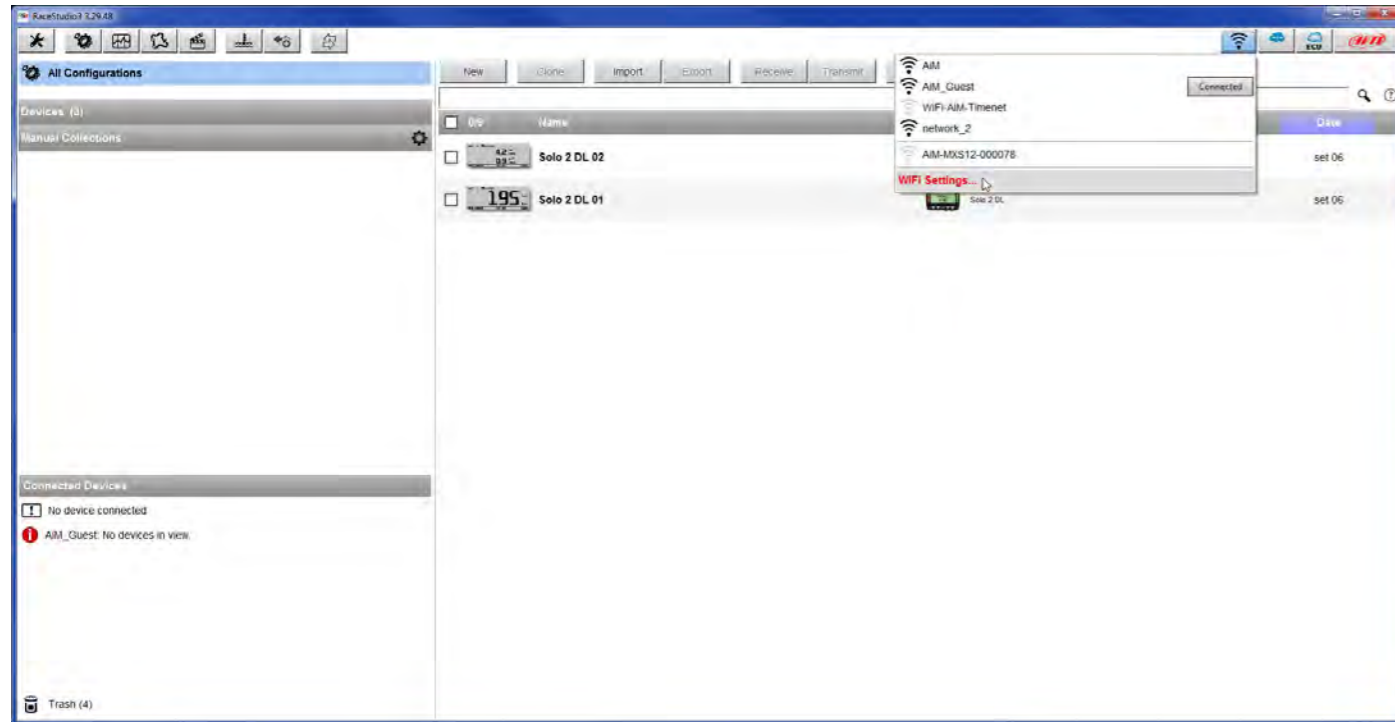

- enable the checkbox shown here below.



7.1.8 Connected device visualization issues

It may occur that using Race Studio 3 on an iMac with virtualized Windows the device connected via Wi-Fi takes some time to be shown in the network or is not shown at all. This is why we always suggest using an Wi-Fi (WLAN) router. This router work as an Access Point allowing more external devices to connect to its network. Solo 2 Wi-Fi configuration is to be set on Existing Network as explained before.

7.2 Configuration of Solo 2 DL

Once Solo 2 DL connected to the PC

- click "Configurations" icon and configurations page appears
- click "New" and new configuration panel appears: select "Solo 2-DL" and press "OK".

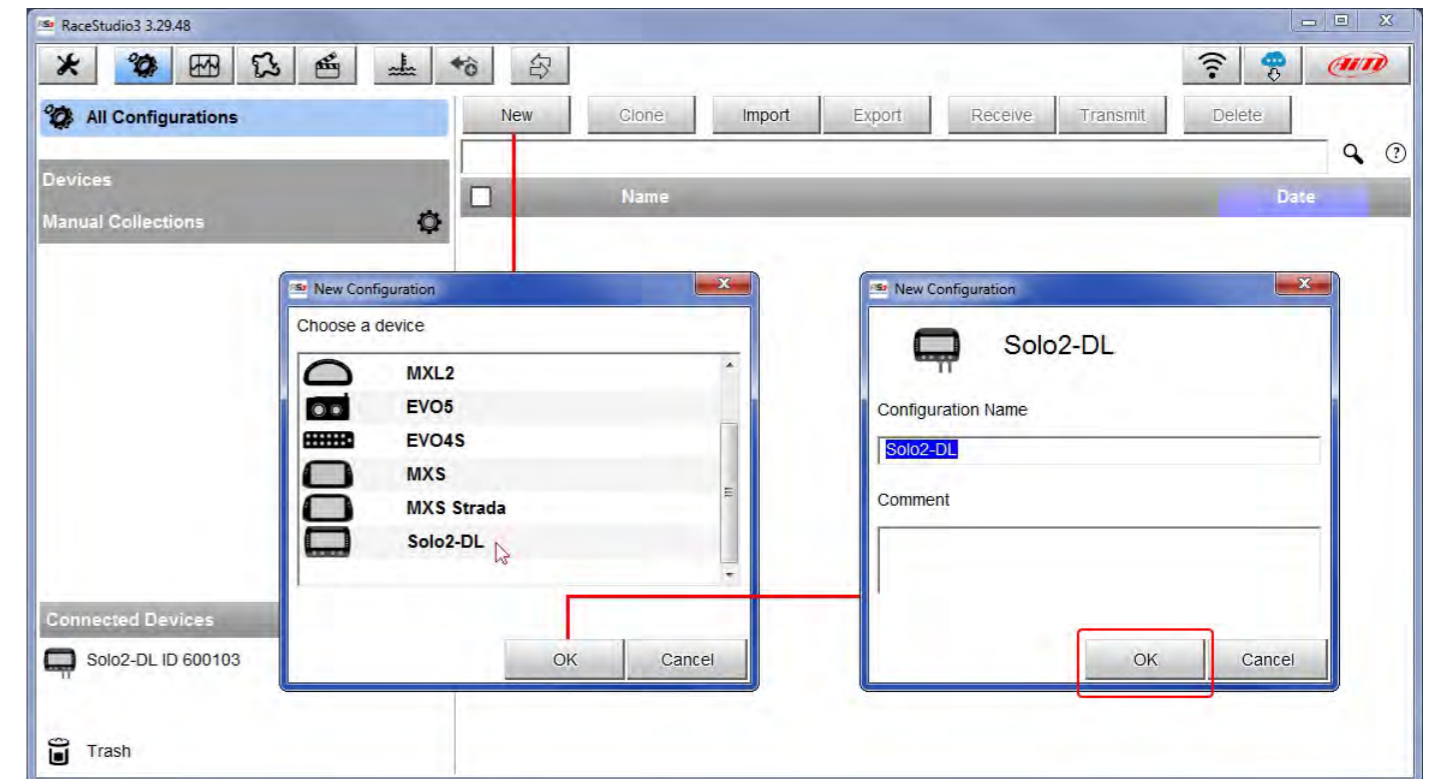

7.2.1 Channels configuration

"Channels" layer opens; all channels are enabled by default. Here you can set all Solo 2 DL channels.

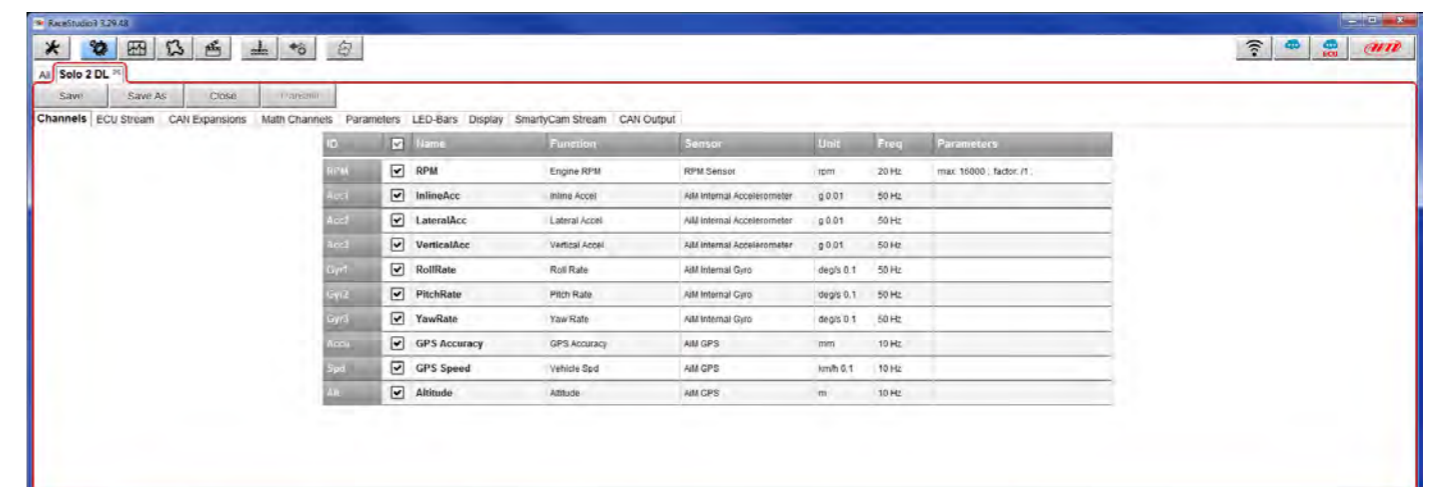

To set a channel just click on its line and the related panel shows up. You can name each channel and set its sampling frequency. Some channels allows you to set measure units, display precision or specific parameters.

7.2.2 ECU Connection and configuration

Solo 2 DL can be connected to your vehicle ECU. When possible documents explaining how to connect your Solo 2 DL to your vehicle ECU are published on our website www.aim-sportline.com. As explained, Solo 2 DL can communicate using all currently available communication lines: CAN, RS232, K-Line.
To load the ECU protocol in Solo 2 DL configuration:

- enter "ECU Stream" tab
- press "Change ECU" button
- select ECU Manufacturer and ECU Model (in the example AUDI/ R8_LMS_GT3_038)
- press OK

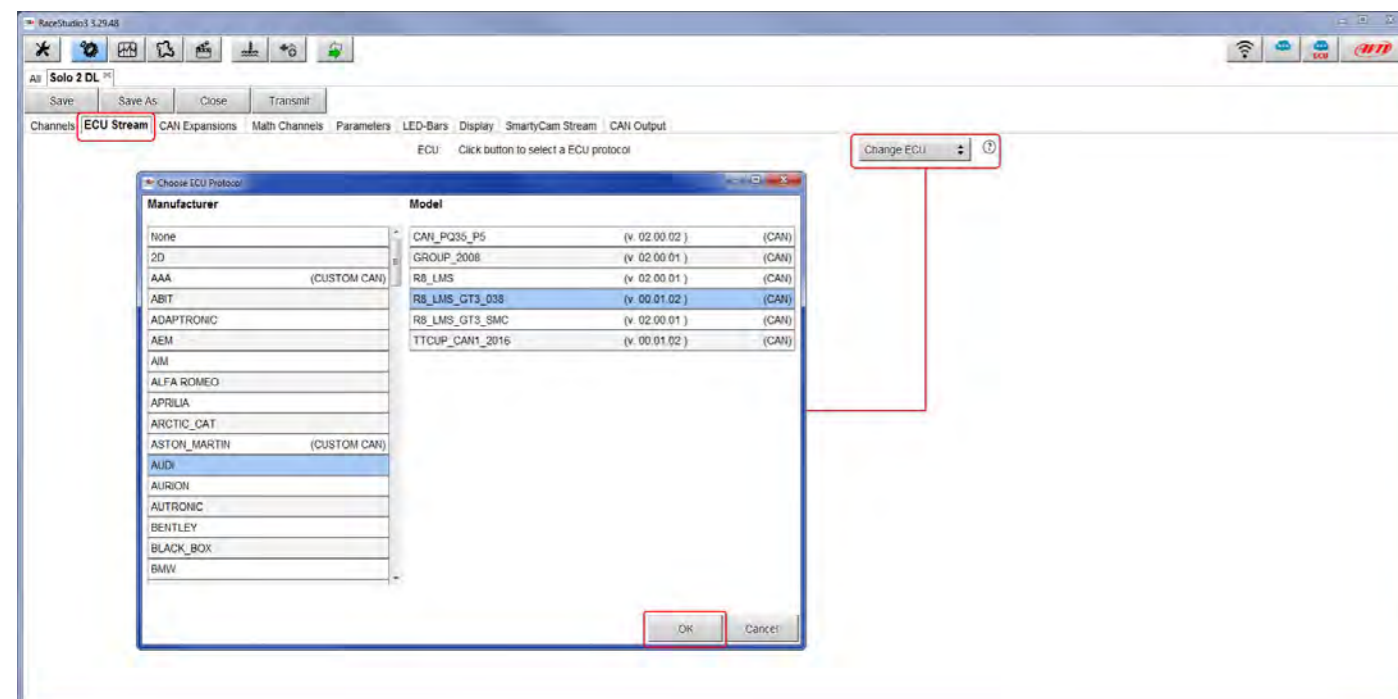

7.2.3 CAN Expansions setting (LCU-One CAN only)

Solo 2 DL can be connected to AiM LCU One CAN lambda controller plugging the 5 pins male Binder connector of LCU one in the female one bottom left of Solo 2 DL.

Once the expansion connected you need to set it:

- enter "CAN Expansions" tab
- press "ADD" button; it switches to "Remove LCU-One CAN"
- name your LCU One and fill in its serial number or press "Get SN from a connected expansion" to receive the serial number from the connected LCU-One
- select the multiplier to calculate AFR from lambda (in the example "14.57 Gasoline") or add a custom value pressing "Add Custom Value"
- set the LCU One channels double clicking on each channel and setting the panel that shows up.

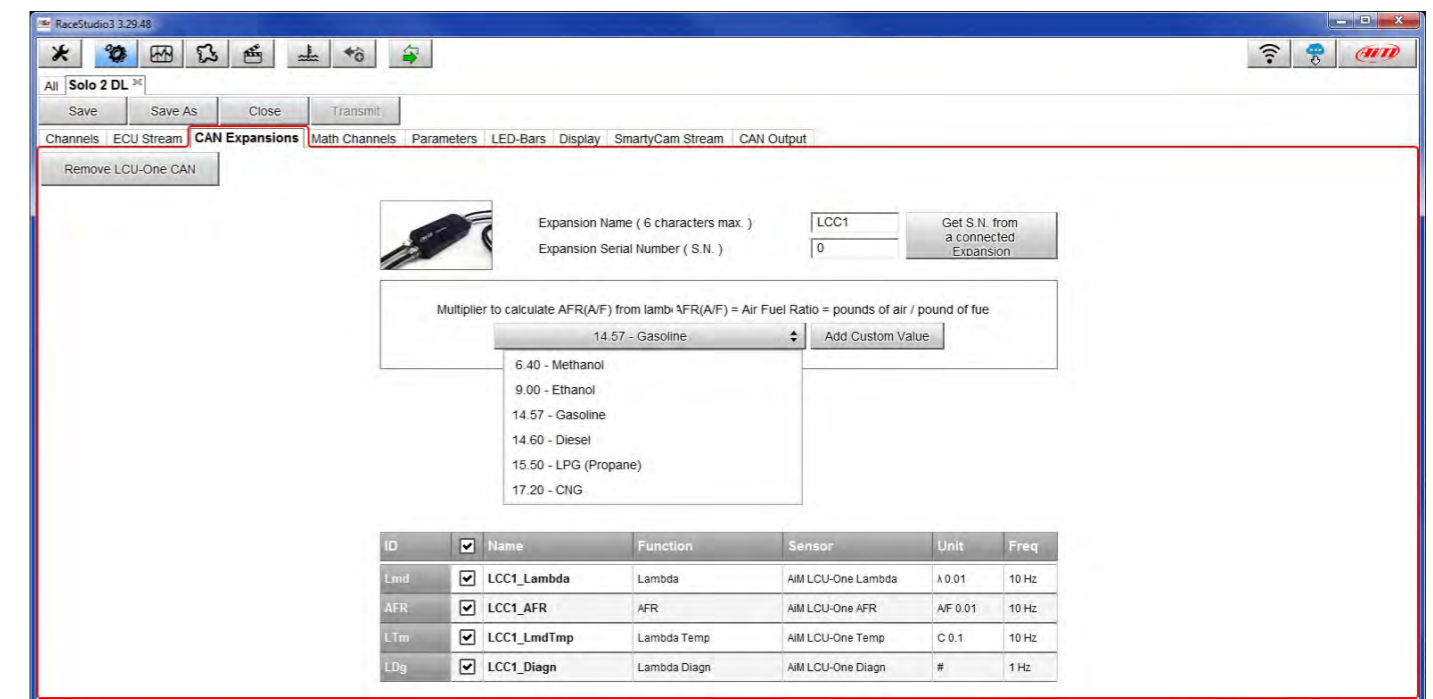

7.2.4 Math Channels setting

To create math channels enter “Math Channels” tab and press “Add Channel” button. Available options are:

- **Bias:** considering a relation between two mutually compatible channels it computes which one is prevailing (typically used for suspensions or brakes);
- **Bias with threshold:** it needs the user to set a threshold value for the considered channels; once these threshold are both exceeded the system makes the calculation;
- **Calculated gear:** it calculates the gear position using engine RPM and vehicle speed
- **Precalculated gear:** it calculates the gear position using Load/Shaft ratio for each gear and for the vehicle axle too
- **Linear correction:** typically used when a channel is not available in the desired format or if it is wrongly tuned and cannot be tuned again.

Each option asks the user to fill in a proper panel.

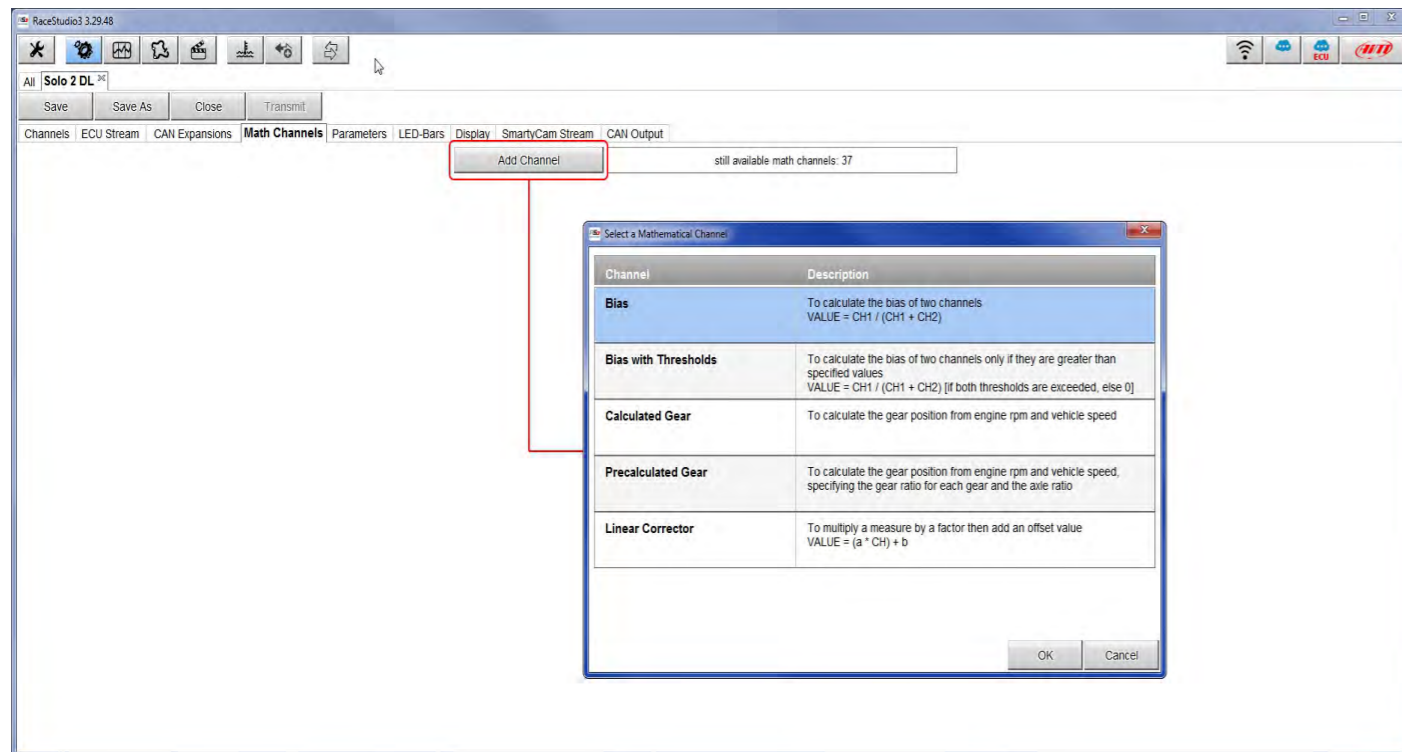

7.2.5 Parameters settings

Parameters page is divided in two part.

- on top **GPS Lap detection** parameters; mousing over the question marks a pop up message will explain you the working mode of:
 - hold lap time for: the time period for which lap time is shown on your Solo 2 DL display
 - the track width: width that will be considered for any GPS point you set
- bottom **Start data recording** conditions;
 - standard conditions (default setting) make Solo 2 DL start recording when RPM is higher than 500 or speed is higher than 10 km/h
 - custom conditions: you can set two conditions and decide if making Solo 2 DL start recording when only one of them is reached (“ANY”) or when both are satisfied (“ALL”); pressing the button shown here below it sets the condition

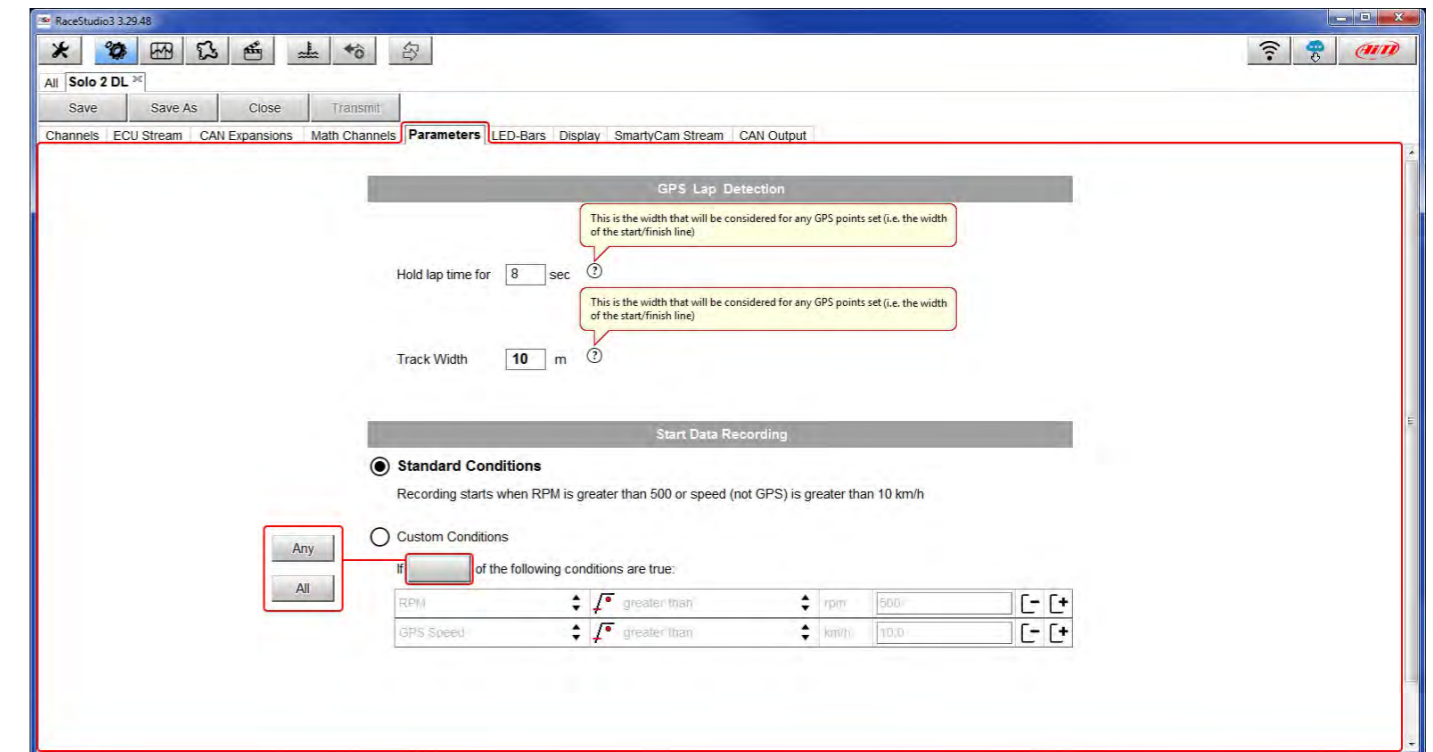

7.2.6 Led-Bars setting

Led bar page sets Solo 2 DL top led bar working mode. Available options are shift lights and predictive time.

Use as gear shift lights (default)

To use the led bar as shift lights click the setting icon () and the related panel shows up. You can

- import/export shift lights setting using the proper buttons
- decide the sequence mode of the LEDs enabling the desired option:
 - a LED stays on if its threshold is exceeded
 - a LED stays on until another LED with higher threshold turns on or
- link the shift lights to the engaged gear enabling the related checkbox; in this last case you need to fill in max gear number and set LEDs colours and threshold values for each gear.

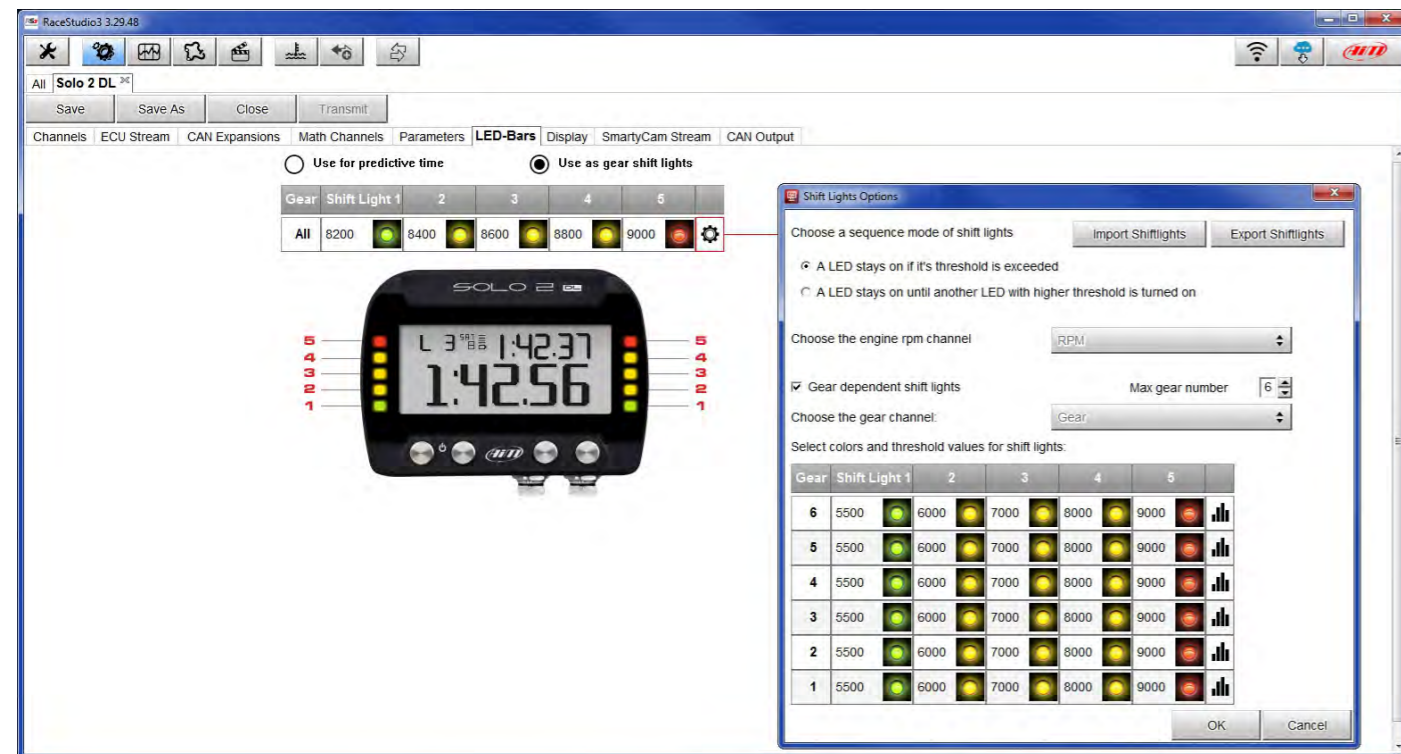

Use for predictive time

To use the LED bar for predictive lap time enable the related option and press the setting icon (). You can

- import/export shift lights setting using the proper buttons
- decide the sequence mode of the LEDs enabling the desired option:
 - a LED stays on if its threshold is exceeded
 - a LED stays on until another LED with higher threshold turns on or
- fill in the predictive time increment of each LED. The LED value indicates the time gap to be assigned to each LED. Assuming you fill in "0.1" and your lap time is improving of 0.3 sec toward the reference lap, your Solo 2 DL will switch on 3 LEDs green; if, on the contrary, your lap time is worsening the LEDs will switch on red. The lap considered as reference is the one you set using Solo 2 DL keyboard in "Type of racing" (see paragraph 6.1).

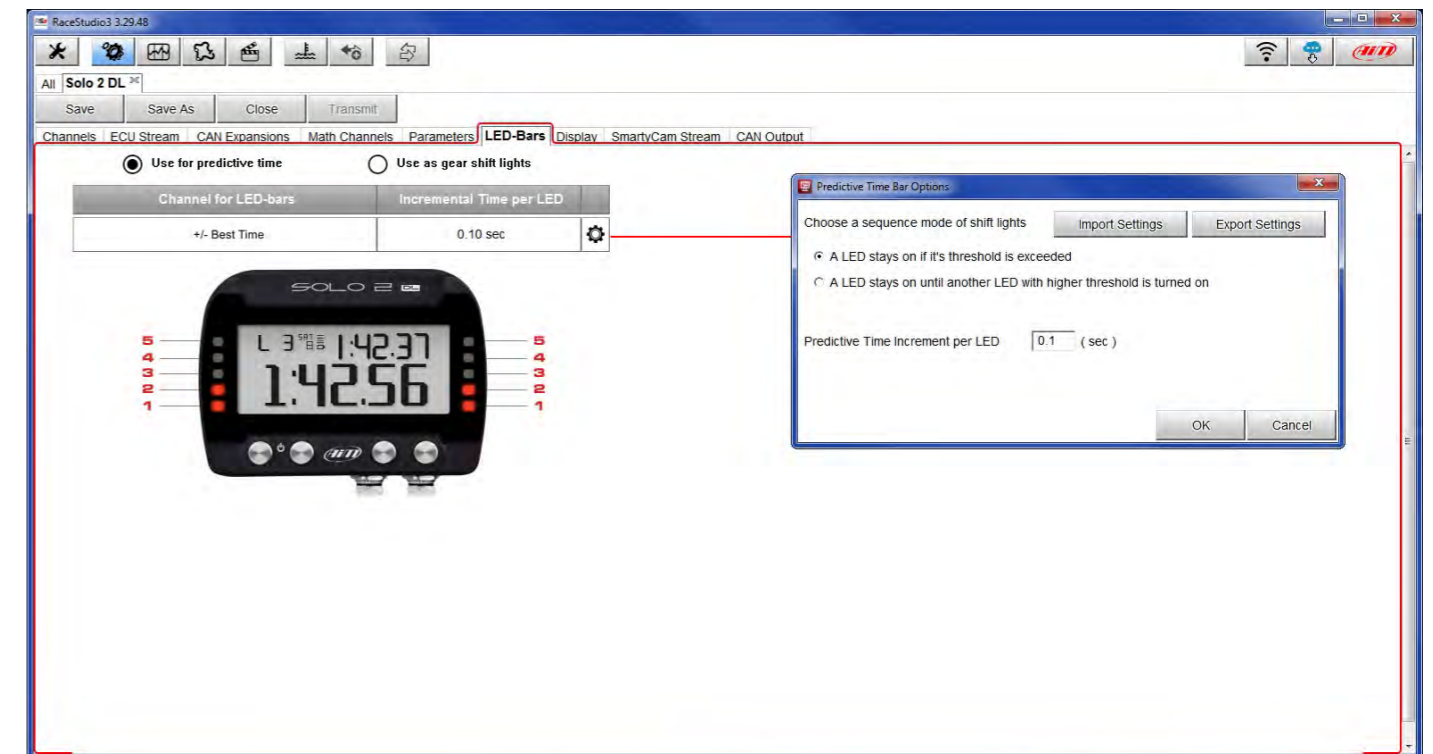

7.2.7 Display settings

Solo 2 DL can have up to eight pages to be set via software. Each page can have from 1 to 4 fields and can be set as you prefer.

- enter "Display" tab
- a panel shows up where you can select the display page you prefer (in the example a four fields page has been chosen)
- select the page and press "OK"
- repeat the operation for the number of pages you want to set

When the page has been selected two setting panels appears bottom of the page:

- on the left a panel that shows as many rows as the fields to be set (in the example four fields)
- on the right a panel shows the channels group you can set in that field and all the channels in it included; you can drag and drop the channel you want to set in the desired field or double click on it
- if you added more display pages the one you are setting is indicated top of the tab as highlighted here below.

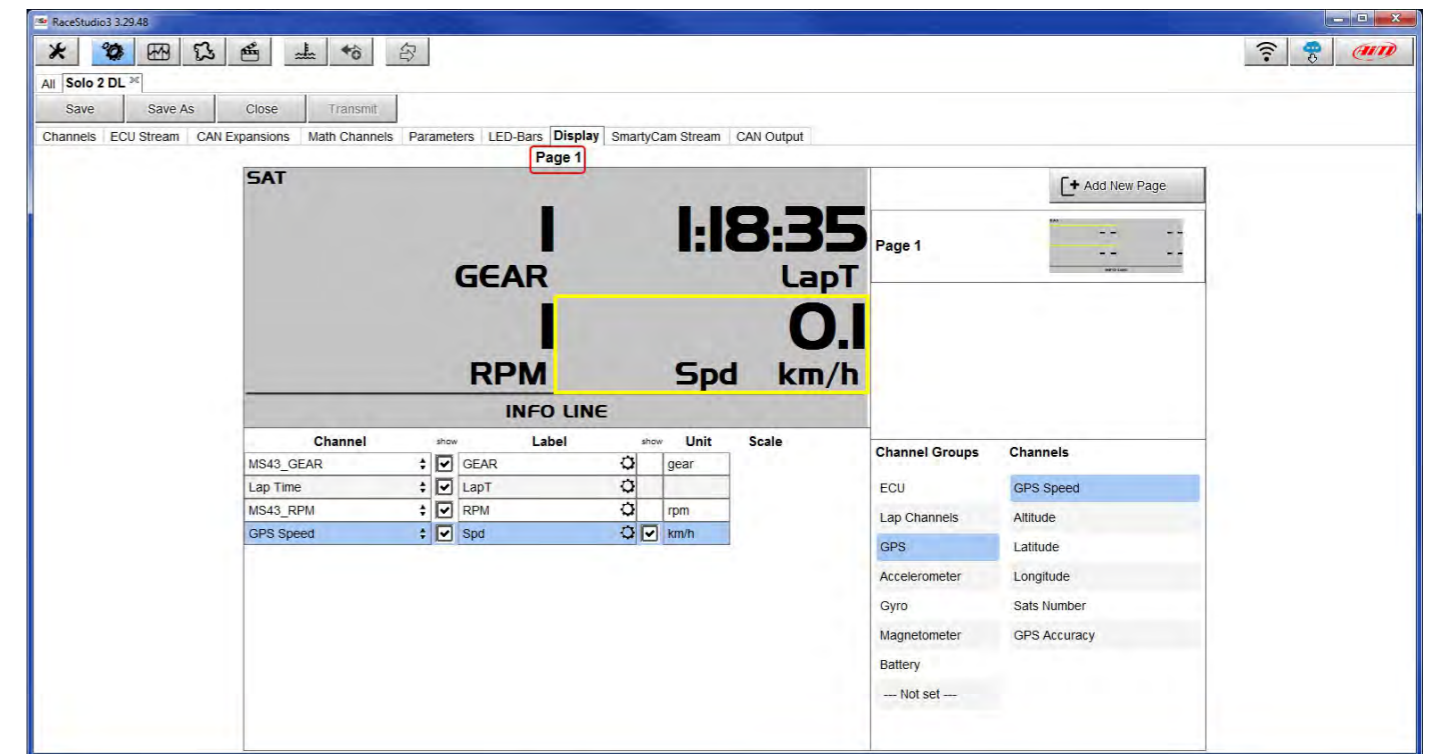
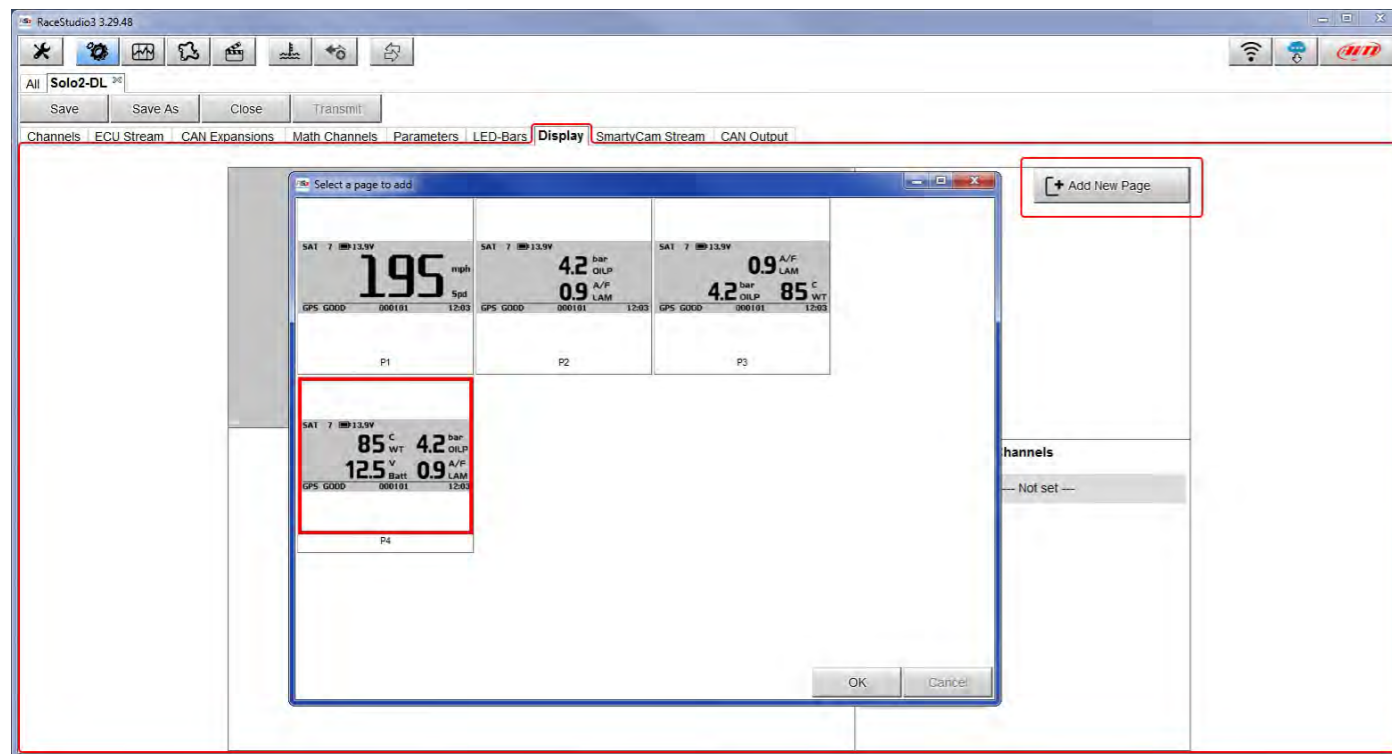

7.2.8 SmartyCam stream setting

- Solo 2 DL can be connected to AiM SmartyCam to show the data you wish on SmartyCam video. To set each channel:
- click on it and a setting panel shows up
 - it shows all channels and/or sensors that fits the selected function
 - in case you do not find the channel or the sensor in the list enable "Enable all channels for functions" checkbox and all channels/sensors will be shown
 - once all channels set press "Transmit" on the page top keyboard.

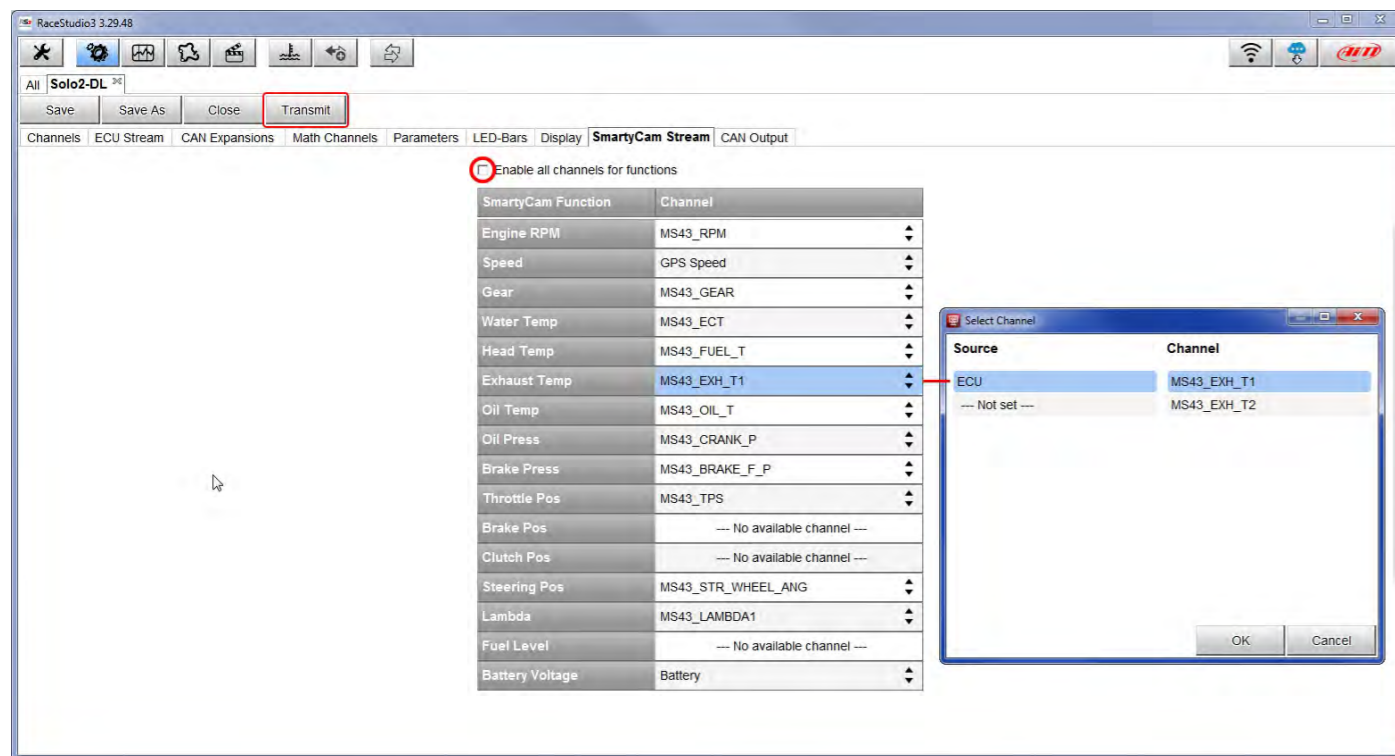

7.3 Transmitting multiple configurations

Once all parameters have been set you can transmit the configuration(s) to your Solo 2 DL selecting them and pressing transmit or in "drag and drop" mode. In "drag and drop" mode the software shows that you are transmitting multiple configurations.

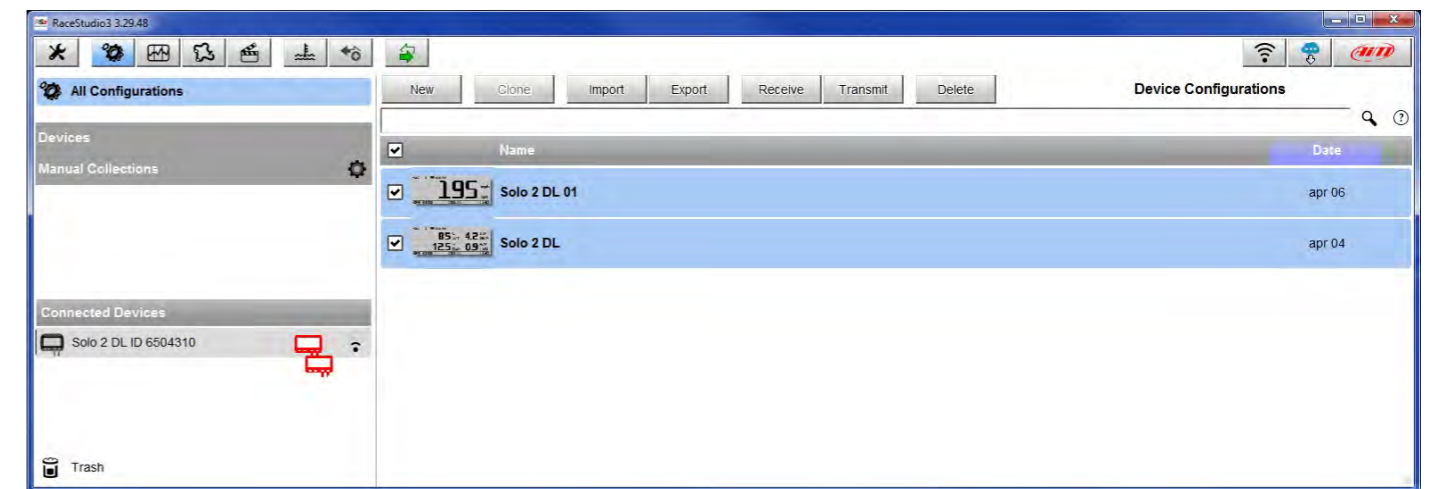

A time bar appears and at the end the software gives confirmation as shown in the image below.

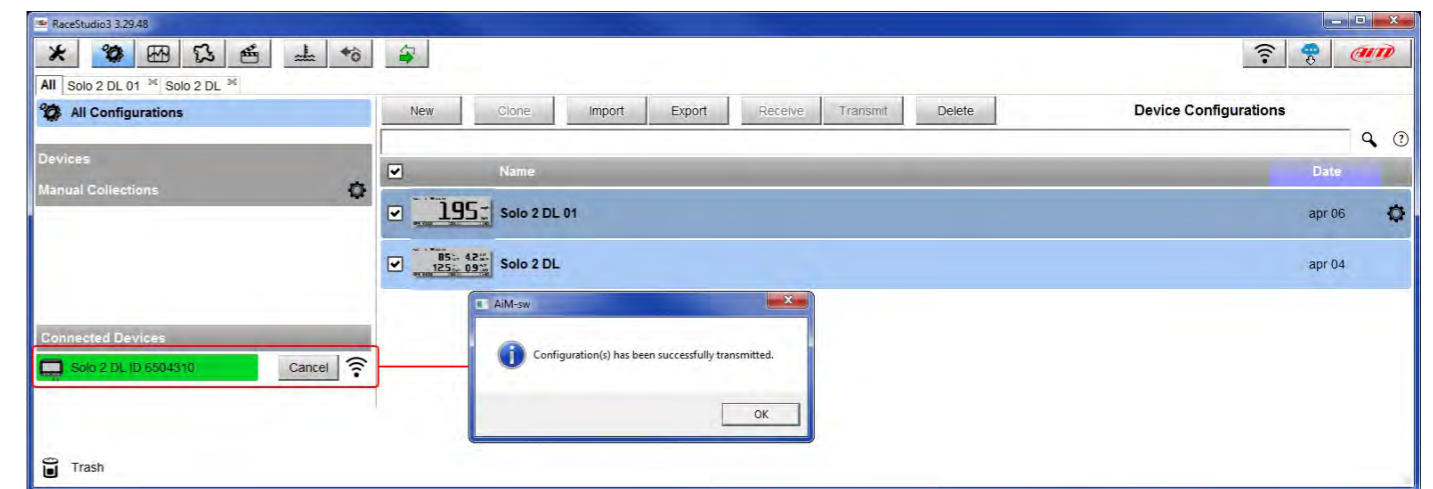

7.4 Managing a track on Solo 2 DL with Race Studio 3

With "Track Manager" function of Race Studio 3 you can create, delete and modify tracks, transmit and receive them to/from your Solo 2 DL. Press "Tracks" icon.



The main page is divided in three columns; on the **left**:

- on top, the filters that allow to collect many tracks following customized criteria; by default, all tracks are shown (light blue "All Tracks" filter in the image below).
- bottom left, the connected devices (in the image, "Solo 2-DL ID 6504310")

The column in the **middle** shows:

- on top a fast search bar, that allows to select the tracks which satisfy your personal research criteria; by pressing "?" a pop-up window shows research examples (highlighted in red below).
- all the tracks listed in Race Studio 3 database. It automatically updates at start up if a connection to the Internet is available.

The column on the **Right** shows:

- the data sheet of the track you are mousing over.

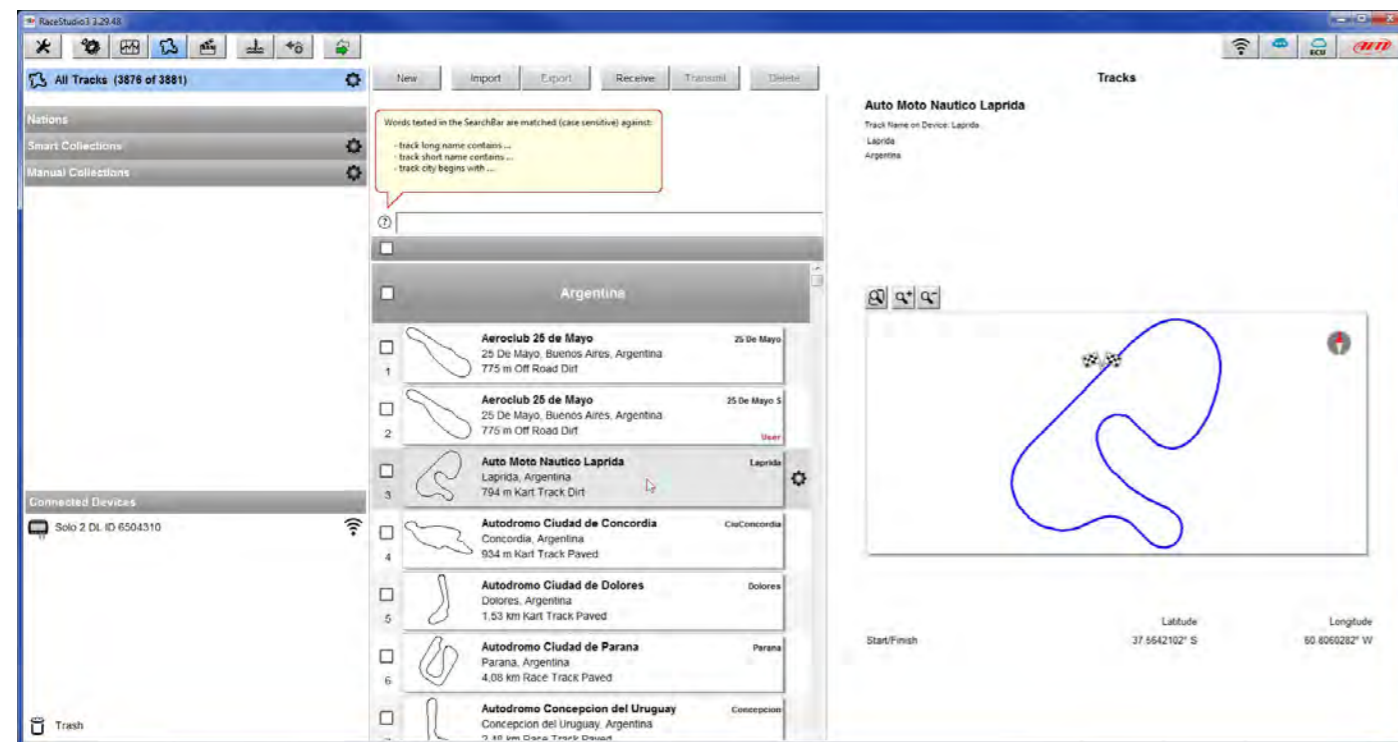

When your Solo 2 DL is connected it is shown on the left bottom part of the page as said before. Clicking on it all the tracks it contains are shown in the right column of the page. The tracks you created are labelled "user" on the right of the track panel.

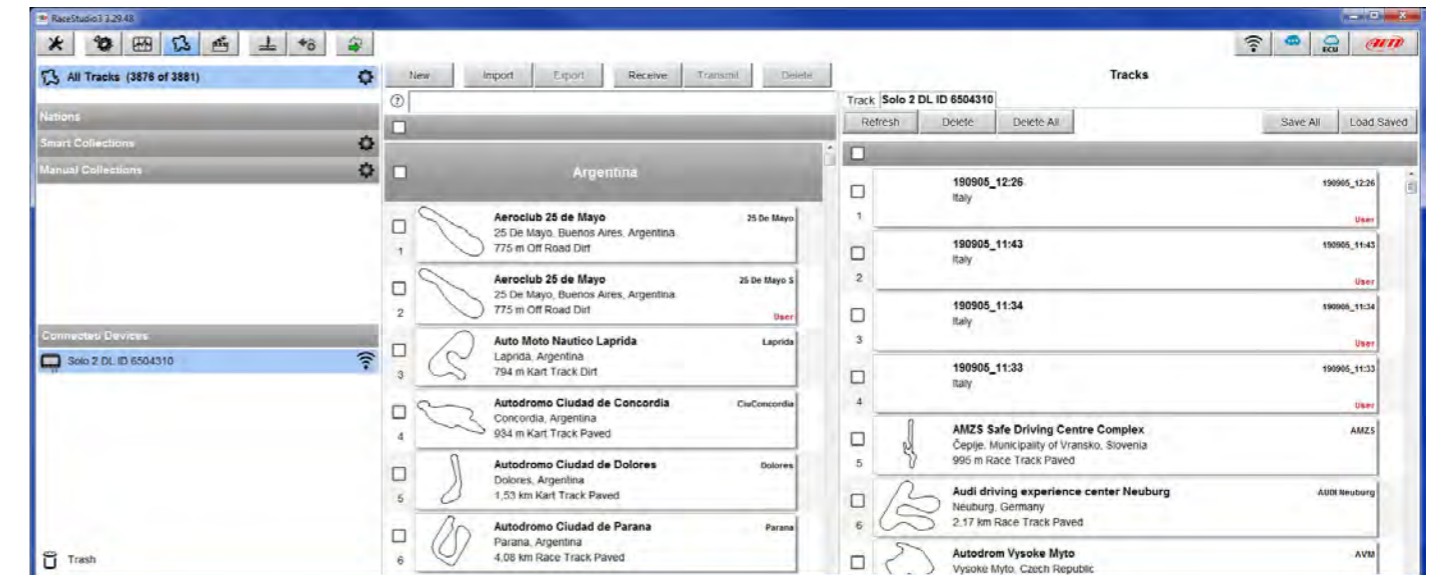

The keyboard you find above the central column allows you to:



- **New:** create a new track
- **Import:** import one or more tracks you stored in your Solo 2 DL or on another external device
- **Export:** export one or more tracks to a specific PC folder or to another peripheral device
- **Receive:** receive from your connected Solo 2 DL the tracks you created (if no device is connected the button is disabled)
- **Transmit:** transmit one or more tracks from the PC to your connected Solo 2 DL (if no device is connected the button is disabled)
- **Delete:** delete one or more tracks from Race Studio 3 Database

The keyboard you find above the right column allows you to:



- **Refresh:** refresh the track list stored in your connected Solo 2 DL
- **Delete:** delete one or more tracks from your Solo 2 DL memory
- **Delete All:** delete all tracks stored in your Solo 2 DL memory
- **Save all:** save all the tracks stored in your connected Solo 2 DL; it creates a zip file you can load to another AiM device
- **Load Saved:** load the tracks you previously saved in your connected Solo 2 DL memory

Creating a track with Solo 2 DL at the end of the session you can connect the laptimer to the PC to add the track map to your PC database.

- click the device name bottom left of Race Studio 3 page
- select the track map and press "Receive": the track map is received;
- to edit it right click on setting icon top right of the page central column and select "temporarily show only user tracks" option.

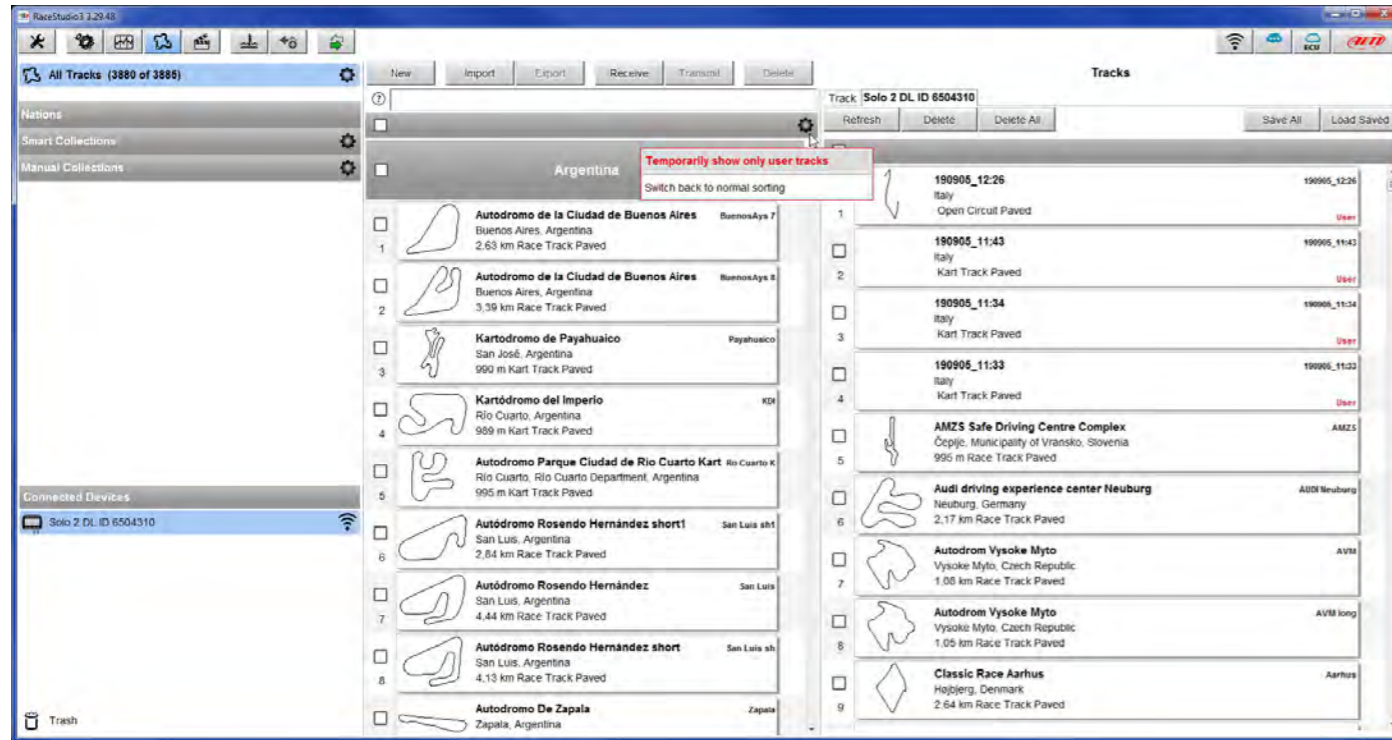

- All tracks created by the user are shown in the central column
- select the track(s) to edit
- right click on the setting icon of the track(s) you want to edit and select "Open selected track(s) for editing"

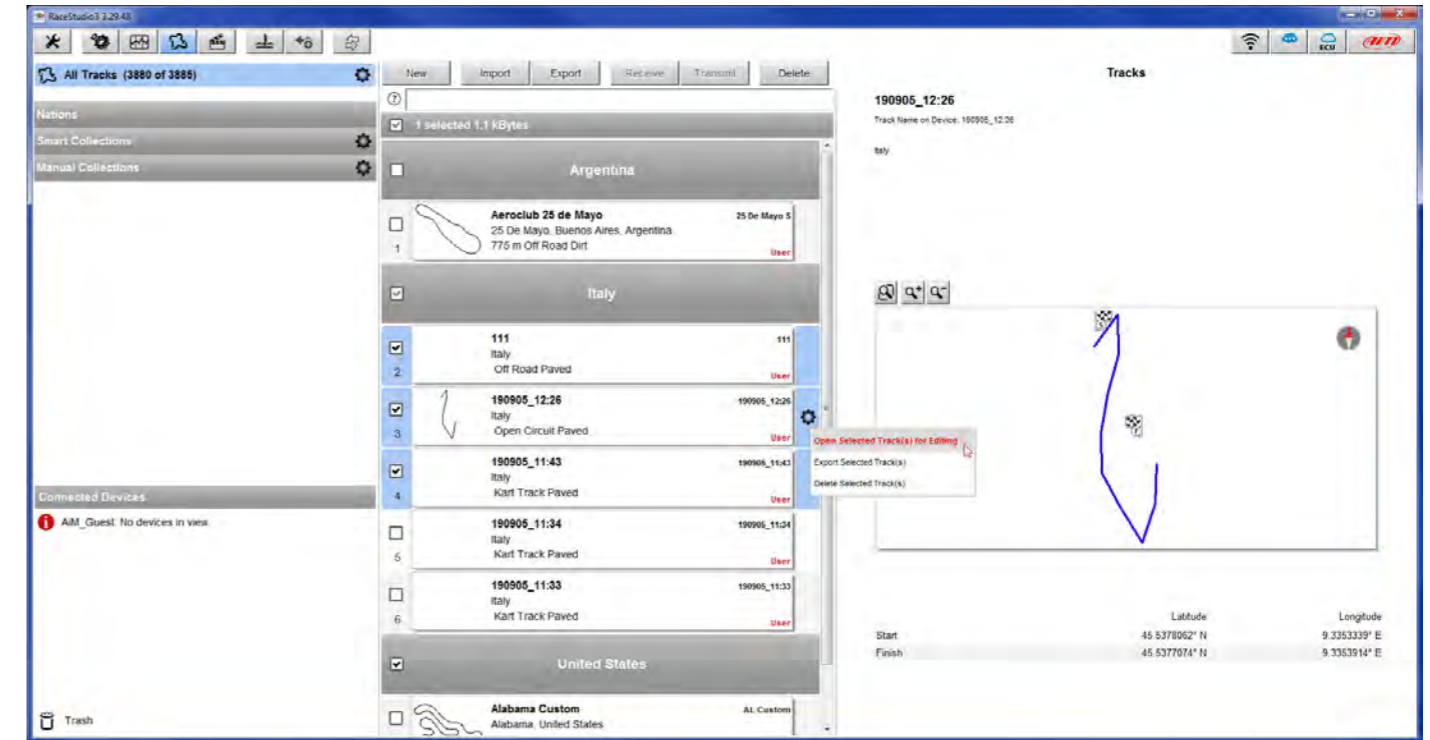

- each selected track is open in a proper layer

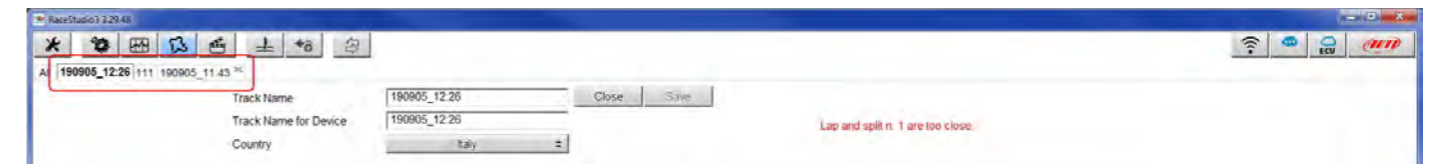

7.5 ECU Driver builder

Each layer allows to add useful information. It may be useful to know that:

- “Track name for Device” is the name you will see on your device (1)
- “Circuit type” and “Road surface”, even if not necessary to set the track, are used by the research filters (2).

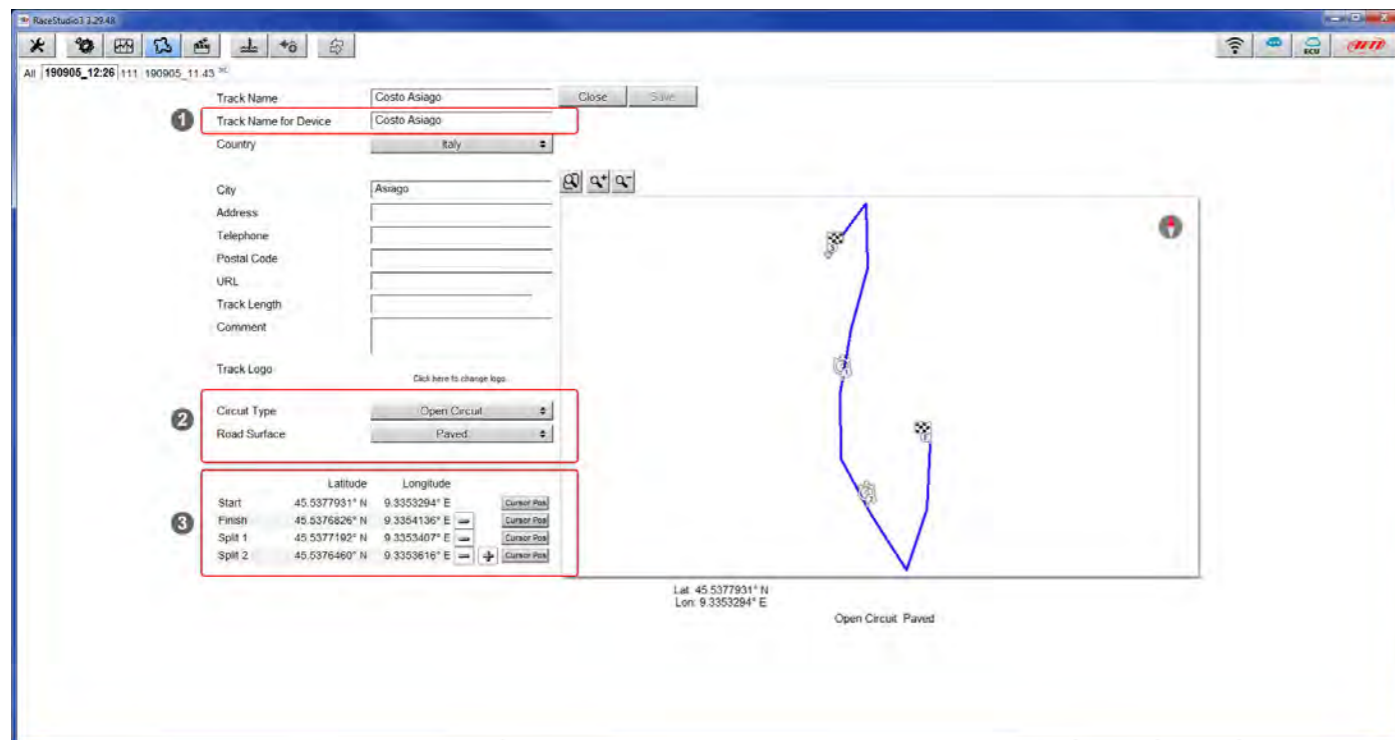

It is possible to change the start line position (move the cursor and set “Cursor Position”) and to add split points in order to organize the track in different segments (3). This will be used in Data Analysis.

Press “Save” and the new track will appear in the list labelled “User”.

Since the software is constantly updated, may be other information or features will be available soon. Please check our website www.aim-sportline.com documentation area software section “Track Manager” manual.

If your vehicle ECU is not included in Race Studio 3 software you can use CAN Driver builder to create your own CAN protocol. Press CAN Protocols button shown here above and then “New”. The panel shown below appears.

You can add a new ECU Manufacturer and/or a new ECU model.

Please note: this Race Studio function is for expert users only and a CAN Driver builder user manual can be freely downloaded from AiM website at www.aim-sportline.com, documentation area software/firmware section.

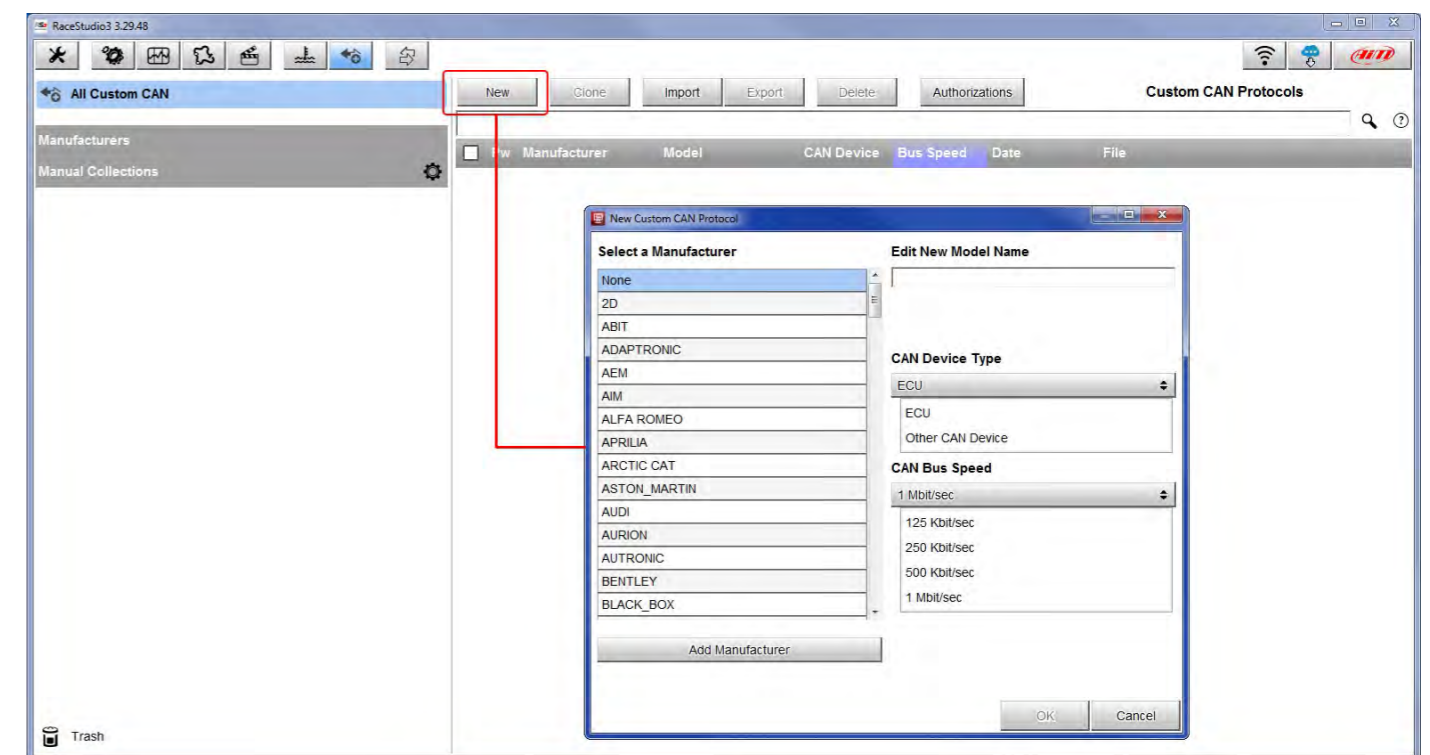

7.6 The device window

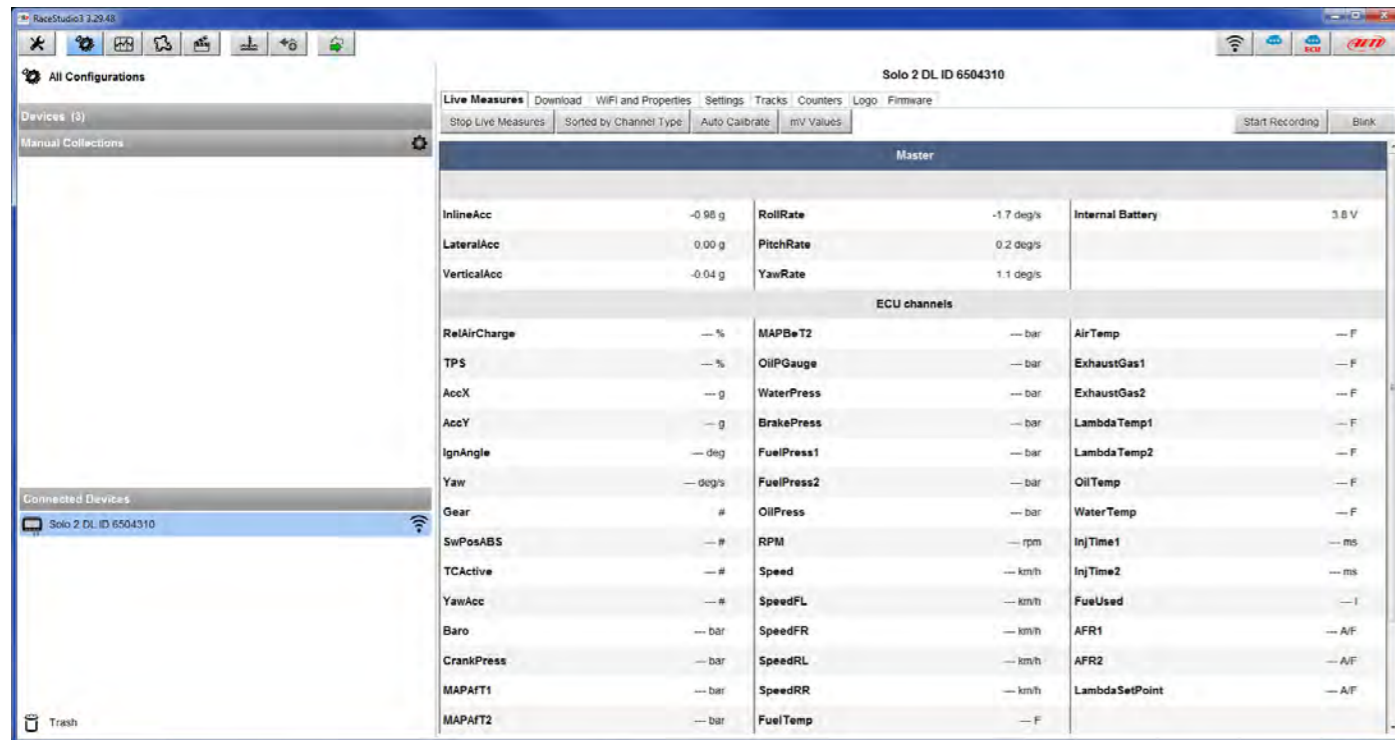

If you click your Solo 2 DL you enter the device window and have these options:

- **Live Measures:** to check all Solo 2 DL channels;
- **Download:** to download data, see the related chapter;
- **Wi-Fi and Properties:** to manage the Wi-Fi configuration – see the related paragraph;
- **Settings** to:
 - set date format
 - enable/disable daylight time
 - set time format and time zone
 - set backlight colour
 - enable/disable night vision
- **Tracks:** to manage the tracks stored in the device memory
- **Counters:** to set each “User” odometer decimal places as well as reset it
- **Logo:** transmit/receive the logo that shows up when switching Solo 2 DL on; supported image format are JPEG or BMP; always use the most recent Windows™ versions (Windows8 or Windows10) whose graphic libraries are more updated
- **Firmware:** to check or update your Solo 2 DL firmware version.

7.6.1 Online value forcing

Starting from Race Studio 3.24.02 Device page Live measures layer features a new and very useful option: online measure value forcing. This feature allows the user to simulate one or more channels value to test icons, alarms, power output and harnesses behaviour.

With reference to the configuration we created it is possible to verify if the LED bar works.

- mouse over RPM value and click the setting icon
- a popup menu appears: select “Force Value” option and fill in the panel that appears
- click “OK” and the LED Bar blinks as set in the device configuration.

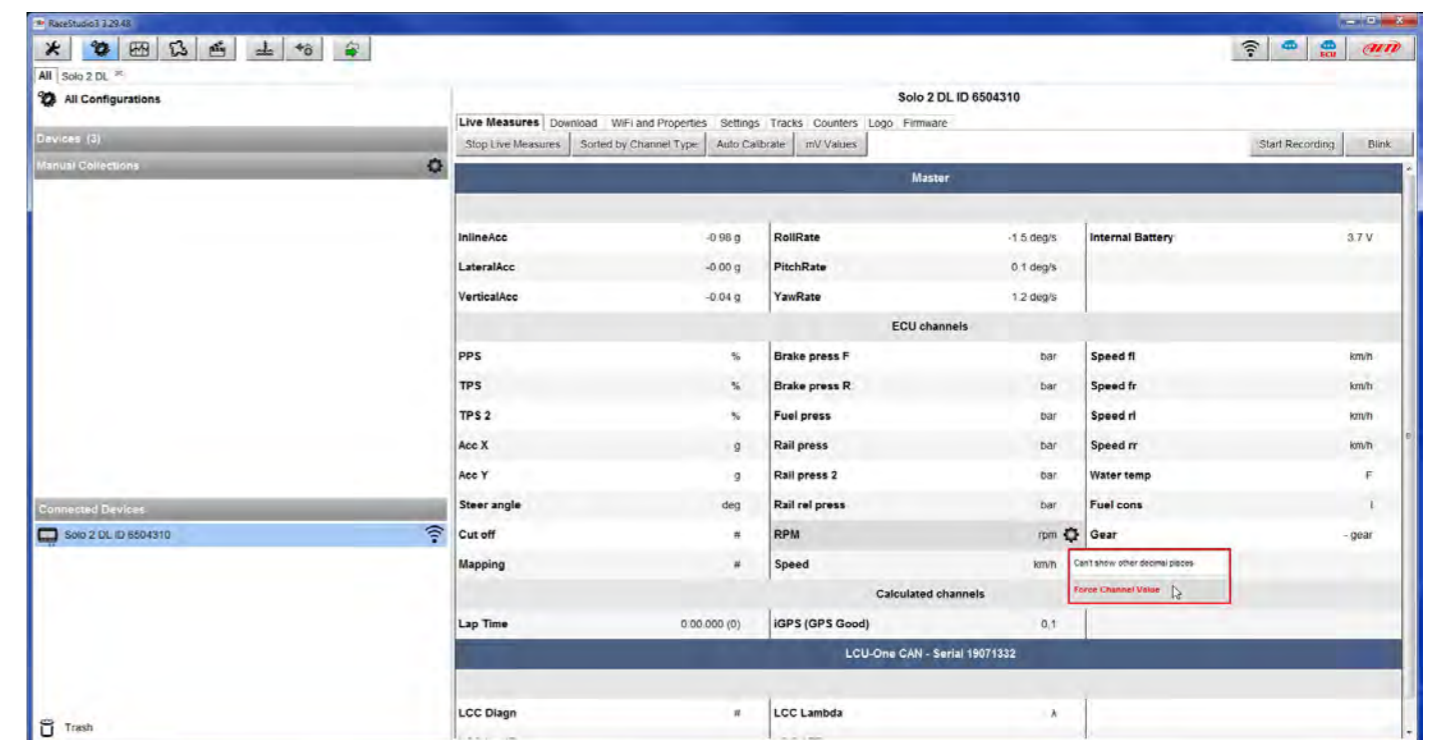

As shown in the image below, once the value has been forced it is shown right of the page hedged in red. With the two “+” and “-” lateral buttons it is possible to change the forced values.

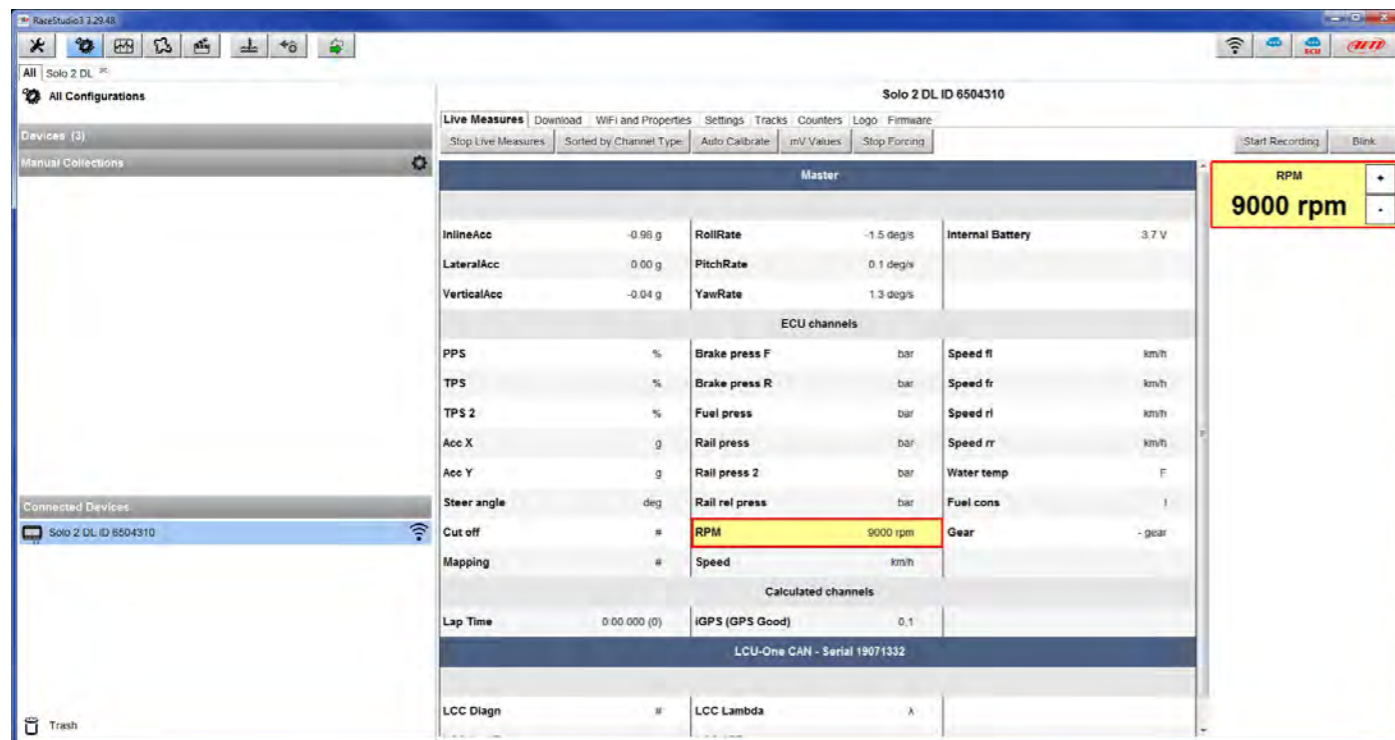

8 On the track

Some Solo 2 pages are available for online visualization. To scroll them press “NEXT” (“Type of Race: Speed” only). Pages can change according to the device configuration. At switch on the setting summary page shows up and it can be recalled pressing first “MENU” and than “EXIT” button.

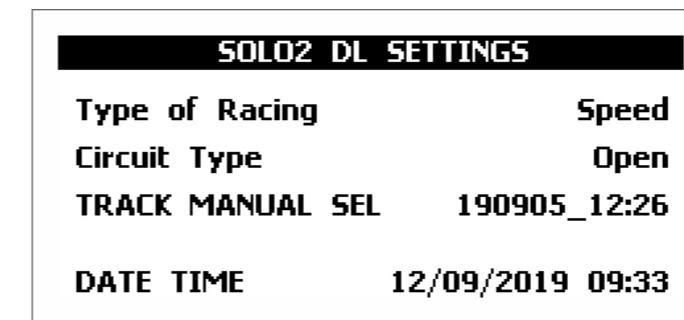

8.1 Track page

After “Setting Summary Page” this page appears and can be recalled pressing “TRACK” button. When you start the engine of your car it goes away automatically. It shows:

- on the left the selected track; you can select a new one manually or automatically (“MENU”/ Track Management); in case of “Automatic” selection the track is selected according to the coordinates of your vehicle; in case the track you are running on is not included in your Solo 2 DL database you can create a new one as explained in paragraph 6.2.1;
- on the right the satellite bar (visible satellites and signal level of each

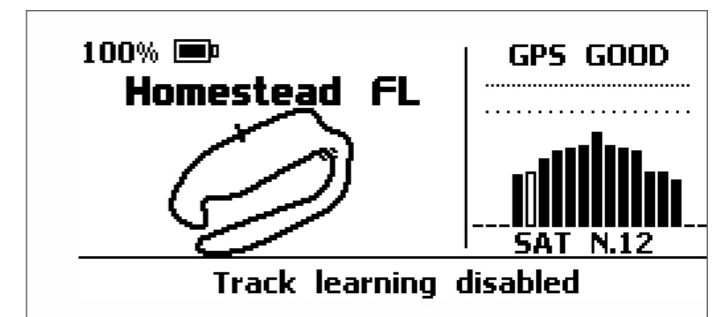

8.2 Other pages

Other available pages are: Laptime Page, predictive Page and eight custom Pages. Use "NEXT" button to scroll them.

Laptime page is shown no matter which type of race you set your Solo 2 on. It shows the lap time.

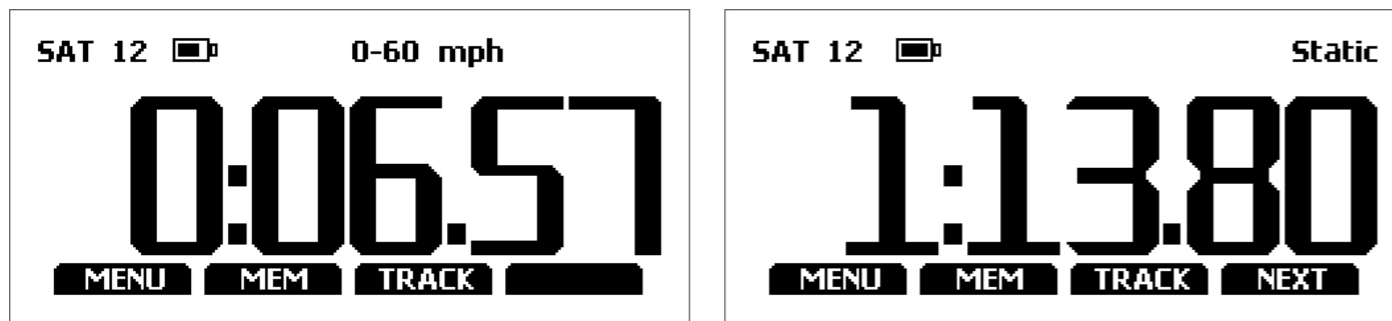

Predictive page:
shows the predicted current lap time in the format you set:
■ +/- in relation to the Reference Lap
■ Predicted lap time

Custom pages you may freely customize up to eight pages for showing all the information you wish. The pages needs to be created as explained in Display settings paragraph (7.2.7).

9 Data recall

At the end of the test you can recall sampled data pressing "MEM". Data recall is different according to the race type you set on Solo 2 DL.

9.1 Data recall "Speed" mode

If you set "Type of Race – Speed" data recall shows these pages.

First is "Summary" page.
Select the session you want to see and press "ENTER"



Once the session selected you see all tests in a box showing time of the test and best lap of the test. Select the test you want to see and press "ENTER".

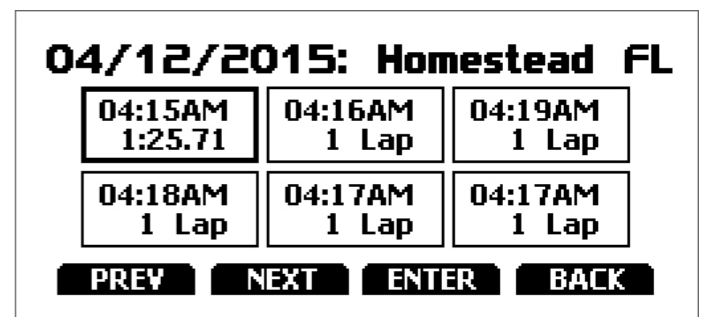

Here you see the three best lap of the test with max speed value of each lap.
Press "PAGE".

04/12/2015 04:15AM		
Lap	Best Laps	mph
4	1:25.71	156.9
3	1:25.86	158.1
5	1:26.12	157.5

This page is a histogram test summary. Moving the cursor left and right you can see all laps.

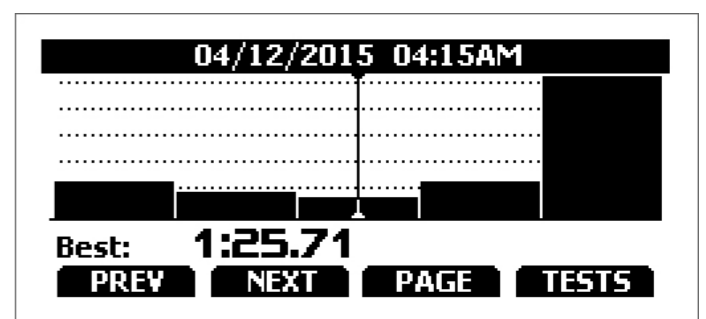

9.2 Data recall “Performance” mode

If you set “Type of Race – Performance” data recall shows these pages.

If your test is max two hours old you are automatically forwarded to the “Test” page. This page shows:

- top right: the selected performance (1/8 mile in the example)
- on the right: the lap time and the speed (09.10 and 72.3 mph)
- on the left: a table showing length, time and speed at the end of the performance and in a set split press “TESTS”

YESTERDAY 03:02AM			1/8 mi	
ft	sec	mph	09.10	
60	01.05	40.9	72.3 mph	
330	15.14	45.1	TESTS	

You come to “Test sessions summary” page, that is the first one you see if your last test is more than 2 hours old. It shows all the sessions from the most recent backwards. Select the session you want to see and press “ENTER”.

TEST SESSIONS	
YESTERDAY	
12/12/2017:	
12/09/2017:	
12/03/2017:	
UP	DOWN
ENTER	EXIT

“Session page” shows you all the laps of the session from the most recent backwards. Press “ENTER” to enter “TEST” page.

YESTERDAY		
03:02AM 0:09.10	03:01AM 0:09.37	02:58AM 0:10.03
02:56AM 0:14.63	02:51AM 0:14.90	02:47AM 0:09.20
PREV	NEXT	ENTER
BACK		

10 Data download

Once Solo 2 DL-PC connection is established activate “Download” tab to download sampled data.

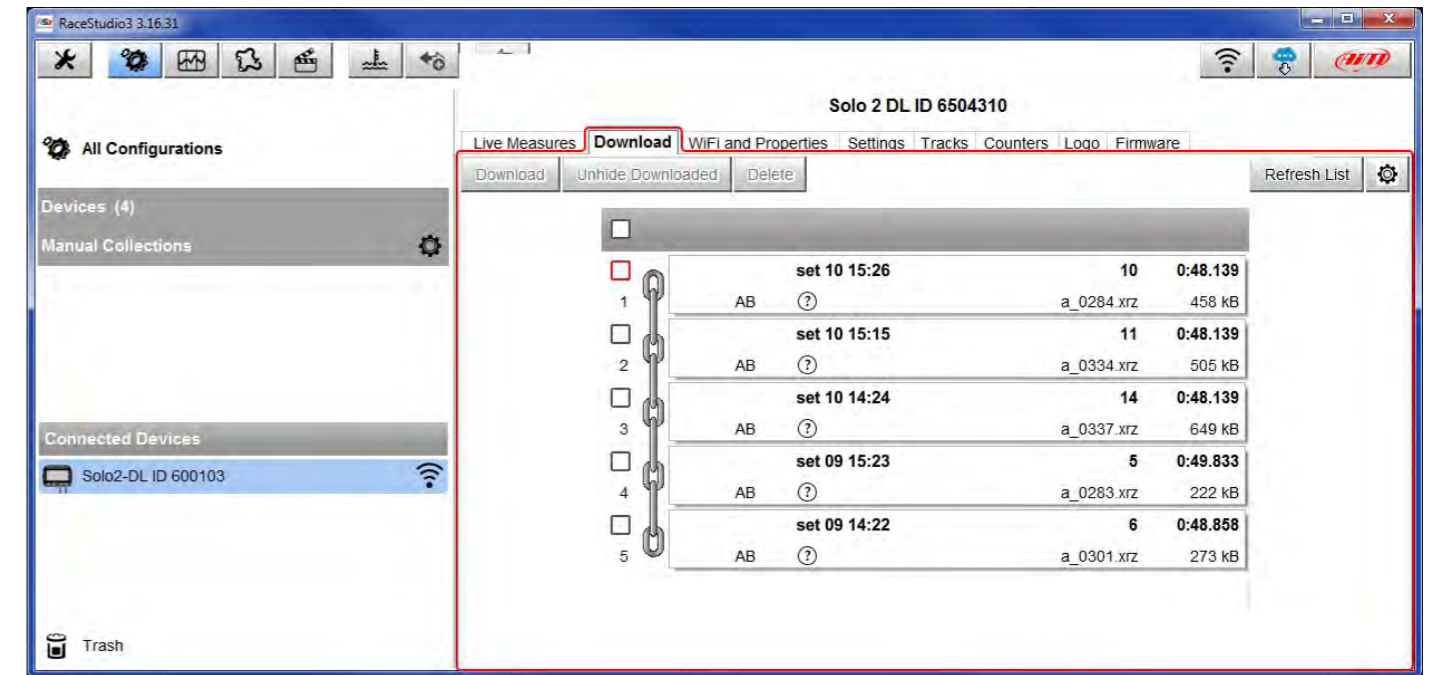

This page shows all information about the files stored in the system: number of laps, best lap, date/time and file dimensions. Select one or more files and press “Download” to download and analyse them.

11 Data Analysis



When data have been downloaded press Analysis icon and Race Studio Analysis software will open showing this page.

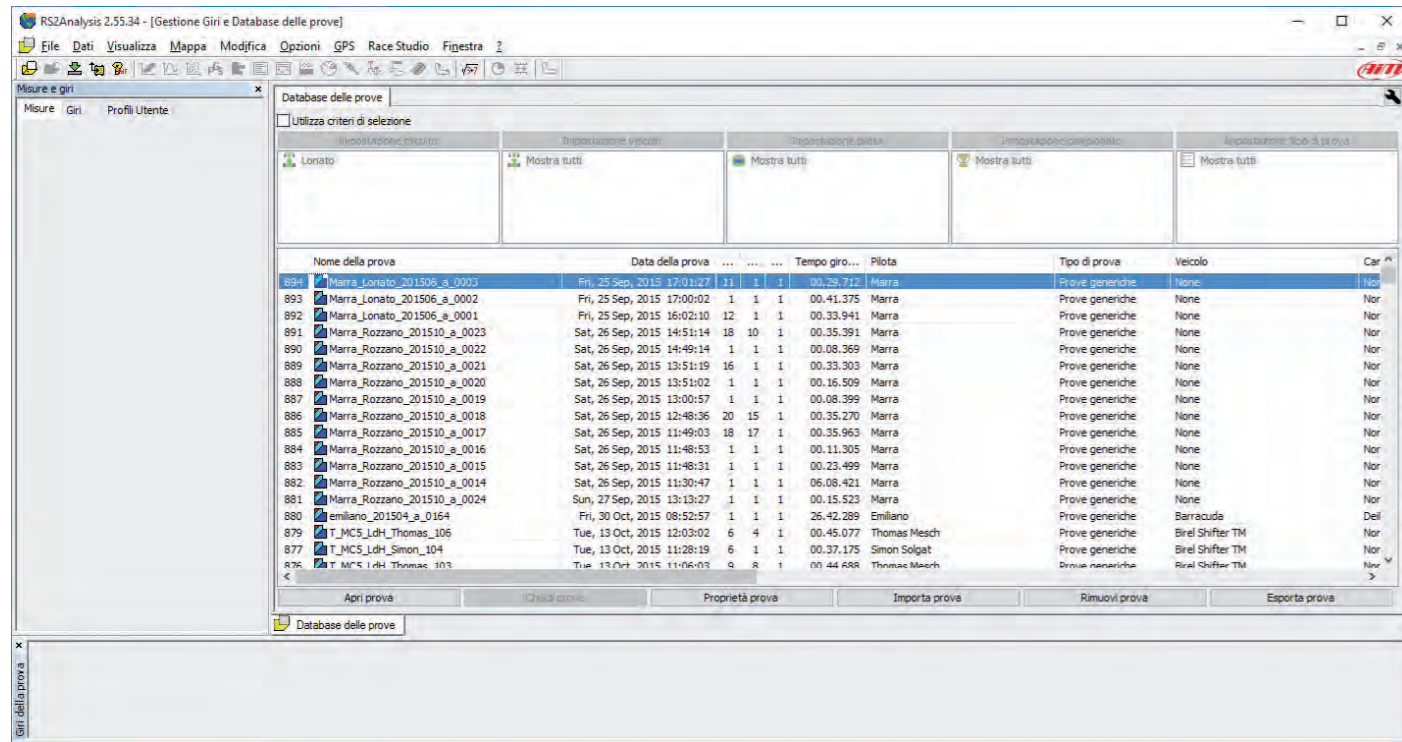

Select your file double clicking on it and start analysing it. A lot of pages, graphs and images will help you analysing your data in the best way.

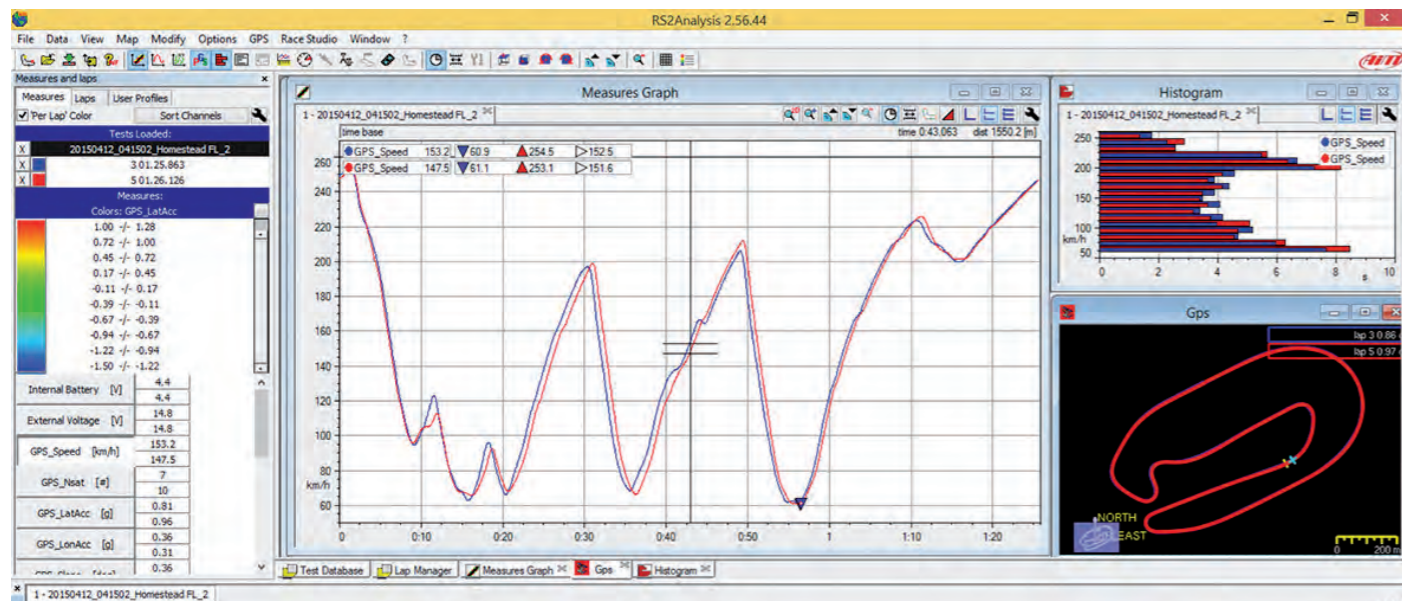

12 – New firmware upgrade



Our technicians and engineers are constantly working to improve both the firmware (the application that manages your device) and the software (the application you install on your PC). Each time a new firmware and/or software version is available the icon here above appears with an arrow indicating that something is available for download (otherwise the icon only shows the cloud). Click it and freely download the new applications.

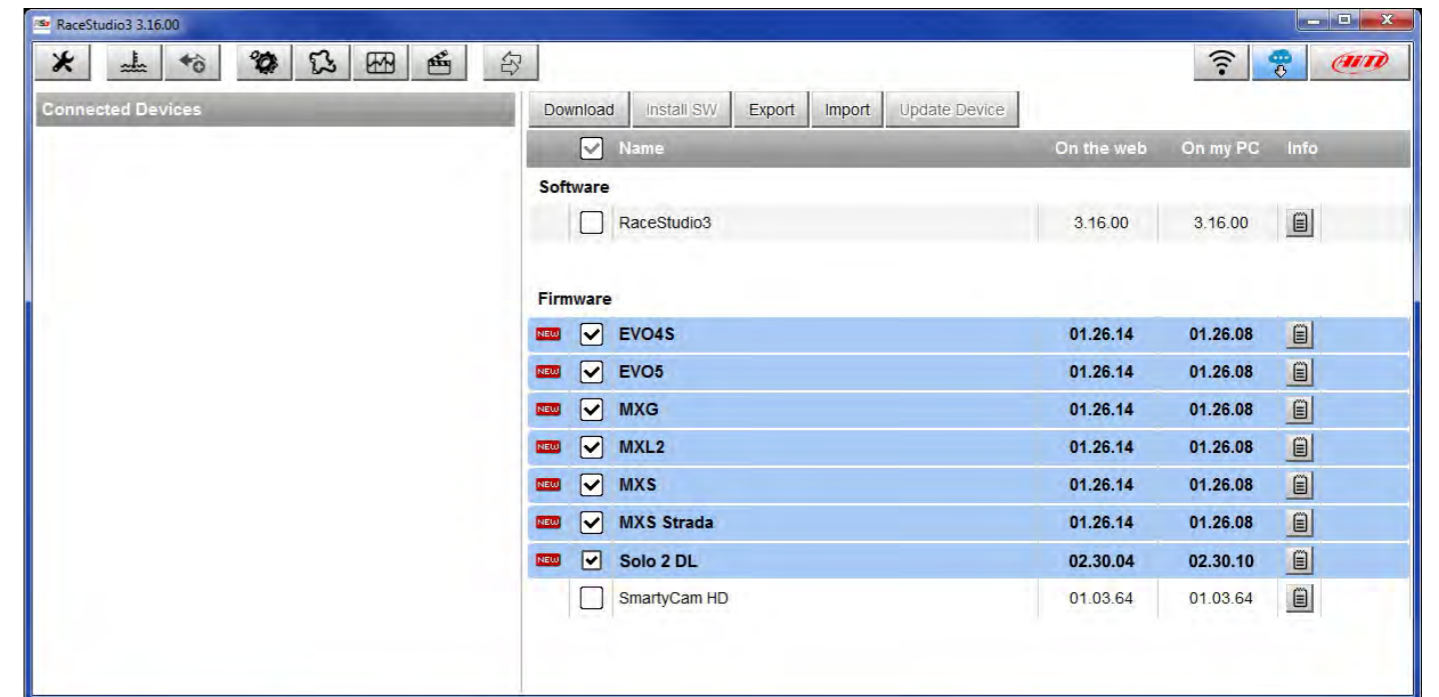

Once the new firmware has been downloaded connect your device to the PC via Wi-Fi to perform a firmware upgrade. In a few seconds the device is ready.

13 RPM

As said Solo 2 DL is sold with different additional cables. To receive RPM value from the ECU you can use one of the available ECU connection cables. If on the contrary your vehicle does not have an ECU you can sample RPM using the RPM+external power cable.

13.1 RPM from ECU

To get the RPM from the ECU you only need to connect your Solo 2 DL to the ECU and it will automatically sample that value.

13.2 RPM via a 5-50V square wave or coil (150-400V)

If your vehicle has no ECU you need to have the kit including RPM+external power cable to be connected to the 8 pins connector placed bottom right of Solo 2 DL. This way Solo 2 DL can read the signal from the low voltage of the coil (whose peak can be from 150 to 400 V) or from a possible square wave (the peak can be from 5 to 50 V). The image below shows an example of wiring of the ignition system.

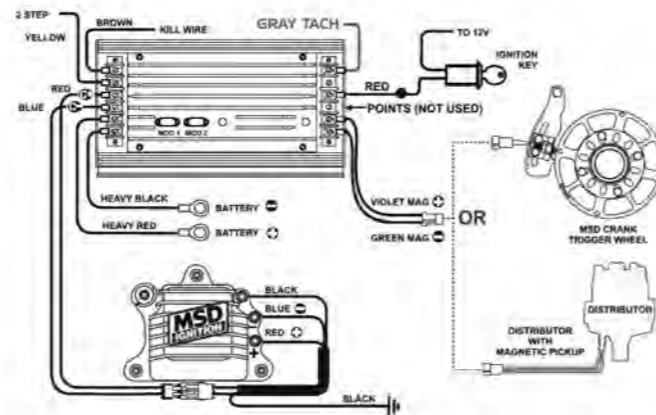

The output labelled "GRAY TACH" gives a 5-50V output that can be directly sampled by Solo 2 DL. In case the vehicle ignition system has no output you need to connect Solo 2 DL to the low voltage of the coil as shown in the following images.

- Point 1:** low voltage of the coil
- Point 2:** connected to the spark plug
- Point 3:** connected to the +12V of the battery

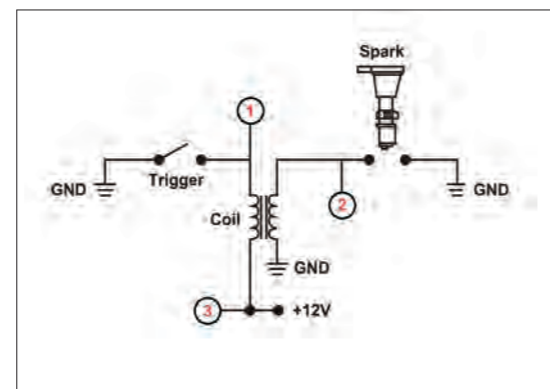
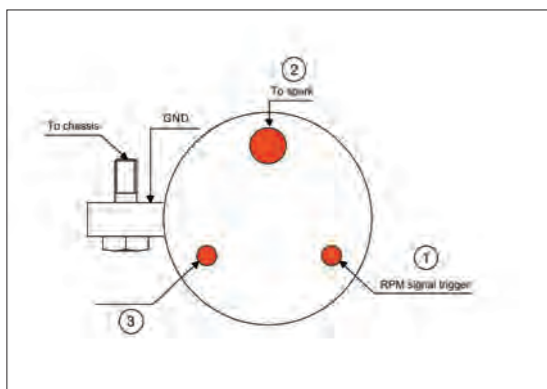

Once Solo 2 DL connected to RPM signal you can set its parameters in channels layer of Race Studio 3.

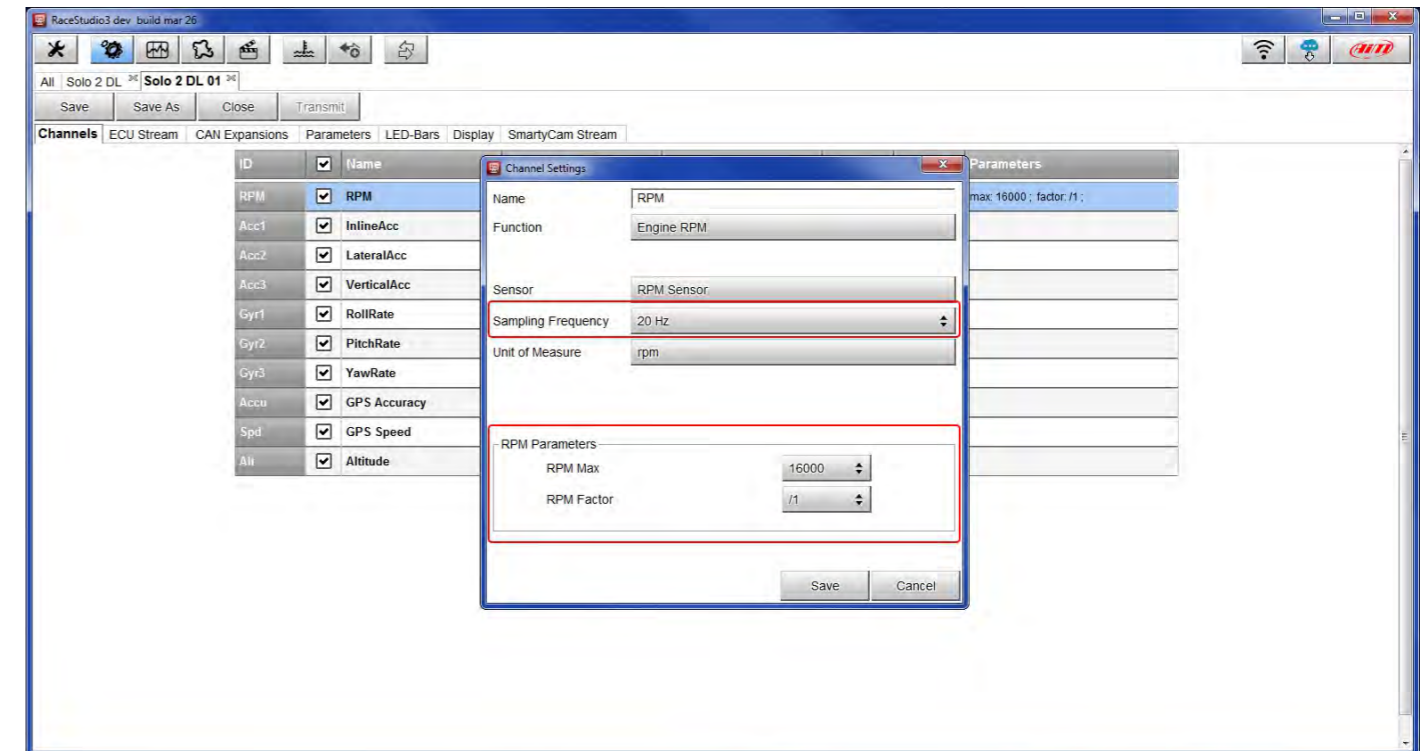

14 Connection with SmartyCam and LCU-One

Your Solo 2 DL can be connected to AiM SmartyCam HD, SmartyCam GP HD and LCU-One CAN as shown in the images below.

Please remember that all channels transmitted by these AiM expansions have to be set in Race Studio 3 software as already explained in the related paragraphs ("LCU-One CAN setting" and "SmartyCam stream setting").

Moreover for further information concerning SmartCam HD, SmartyCam GP HD and LCU One refer to the related manuals you can download from "Documentation" area of AiM website www.aim-sportline.com.

To connect Solo 2 DL to SmartyCam HD use SmartyCam CAN cable and connect 5 pins Binder connector placed bottom left of Solo 2 DL to 7 pins Binder connector placed rear left of SmartyCam HD as shown here below.



15 Technical specifications and drawings

To connect Solo 2 DL to SmartyCam GP HD use SmartyCam CAN cable and connect 5 pins Binder connector placed bottom left of Solo 2 DL to 7 pins central Binder connector of SmartyCam HD as shown here below.



To connect Solo 2 DL to LCU-One CAN connect 5 pins Binder connector placed bottom left of Solo 2 DL to 5 pins Binder connector of LCU-One as shown here below.



- Display
 - Display resolution
 - Display pages
 - Backlight
 - Shift lights/alarm LEDs
 - Integrated track database
 - Inertial platform
 - Wi-Fi connection
 - Integrated GPS
 - ECU Connection
 - External power
 - Memory
 - Battery type
 - Pushbuttons
 - Weight
 - Dimensions
 - Waterproof
 - Analysis software
- Graphical
238x99 pixels
Up to 8 freely configurable
7 configurable RGB colour
10 configurable RGB LEDs
Yes
Internal 3 axis ±5g accelerometer + 3 axis gyro+ 3 axis magnetometer
Yes
10Hz GPS+Glonass
CAN, RS232, K-Line
12V
4GB
Rechargeable Lithium
Metallic
240g battery included
98x73.7x30.2mm
IP67
Race Studio Analysis freely downloadable
from www.aim-sportline.com

Pinout Solo 2 DL

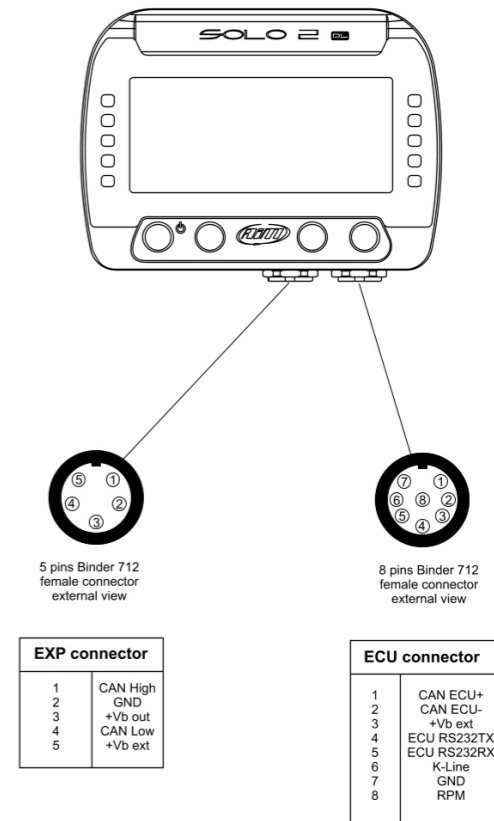

CAN+RS232+External Power cable – 2m length

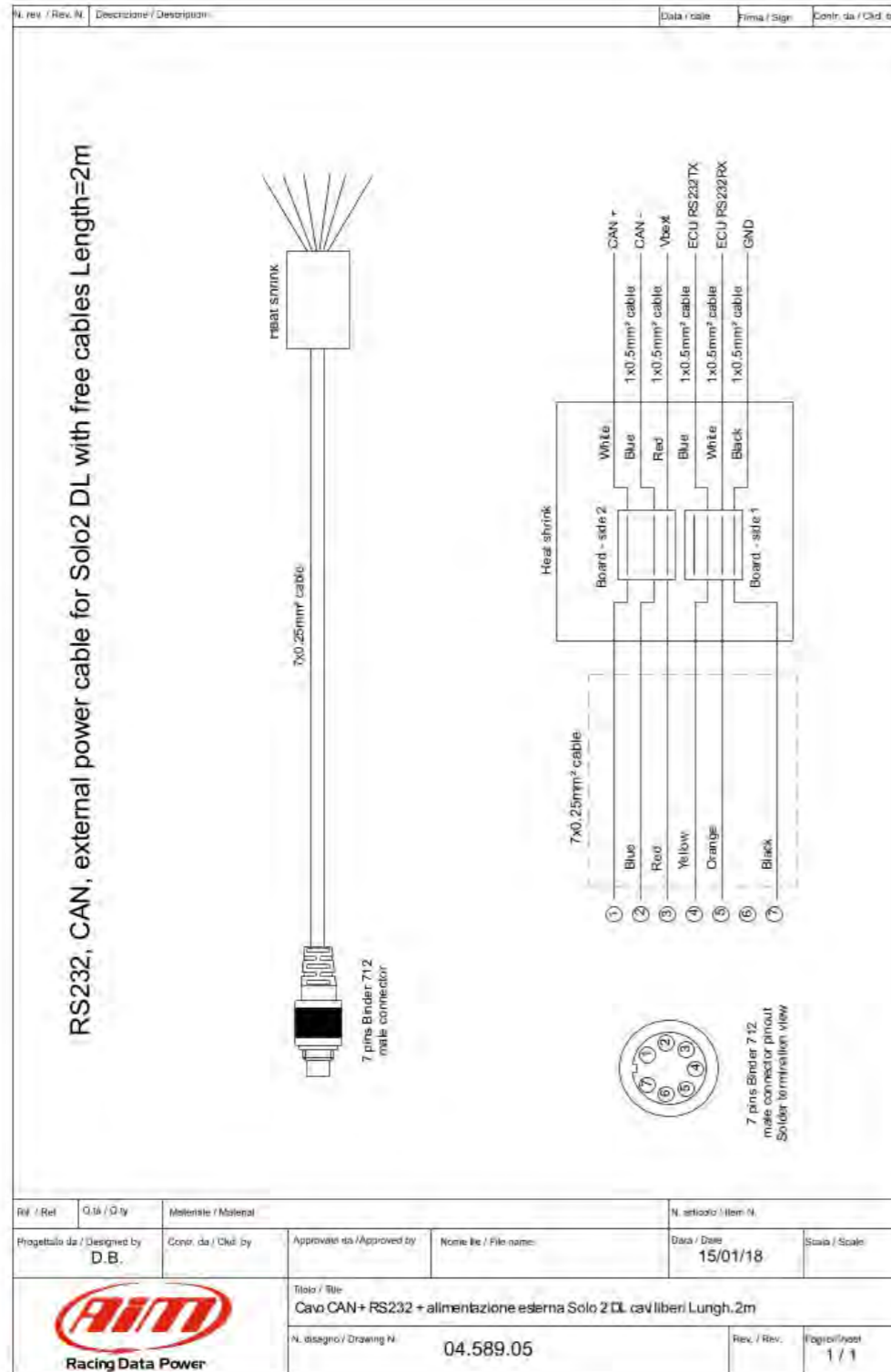

CAN+K-Line+ power cable with OBDII connector – 2m length

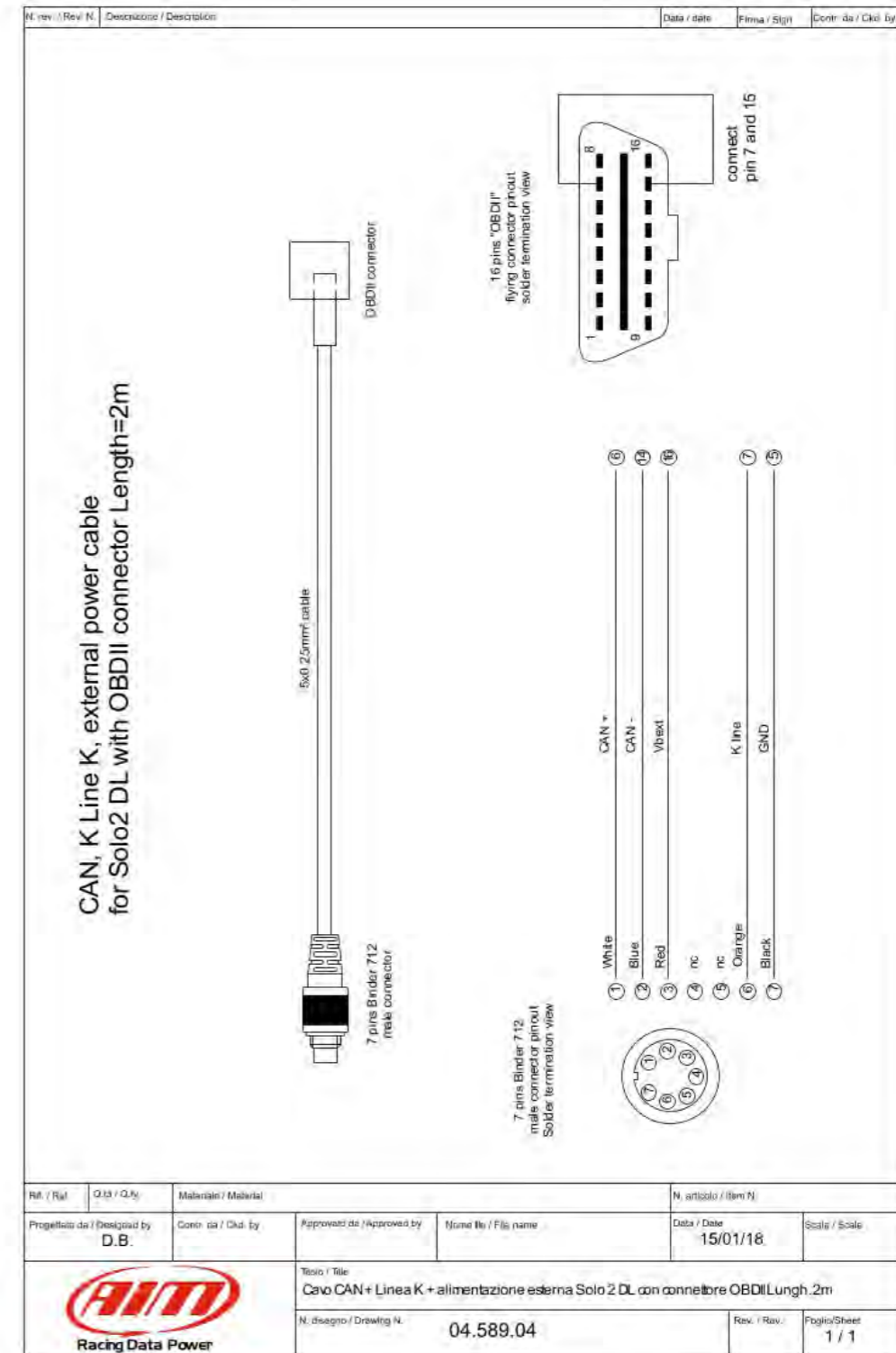

RPM+Power cable – 2m length

