

MILANO KFM36

Sink: DL36SINK

Dimensions:	width	depth	height
inches	35.7"	18.5"	35.12"
mm	906	470	892

NOTE: DIMENSIONS AND TECHNICAL DETAILS ARE SUBJECT TO CHANGE WITHOUT NOTICE

. FRONT ELEVATION

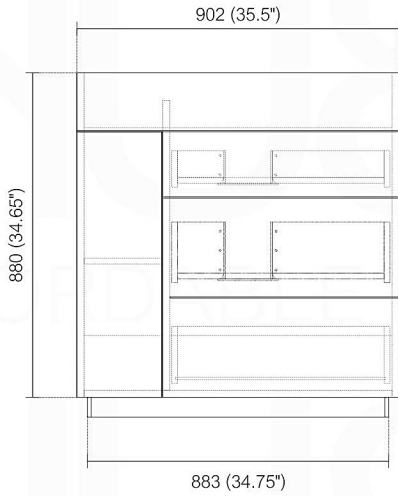

. SIDE ELEVATION

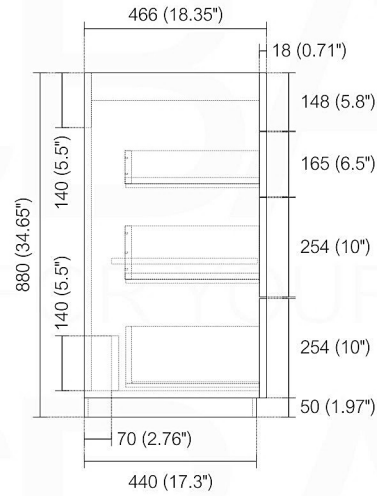

. TOP ELEVATION

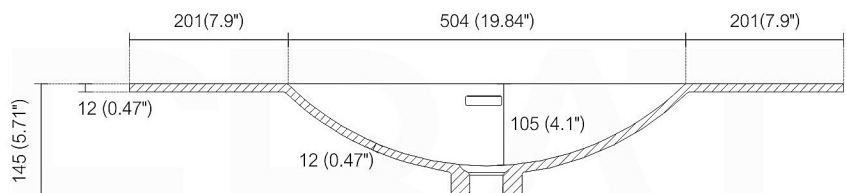
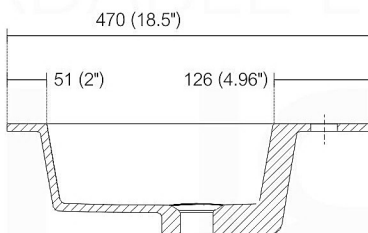
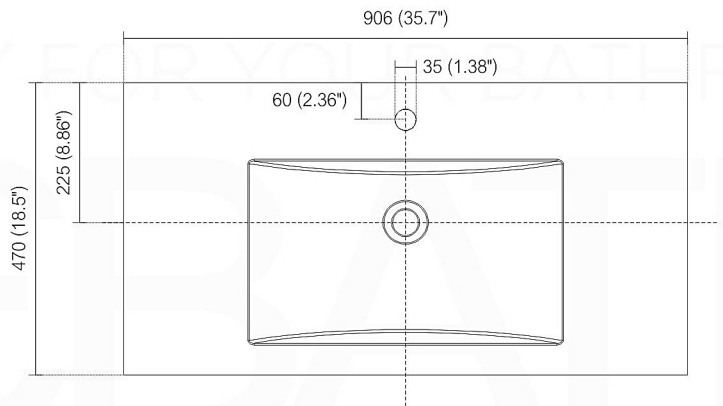
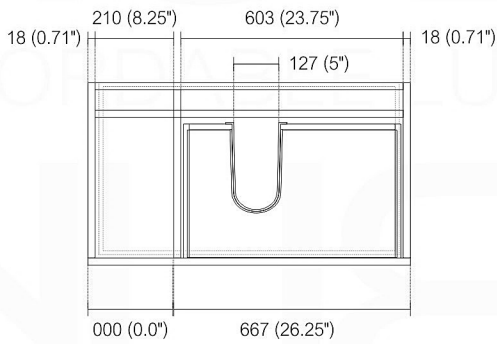

How to Install a Milano Vanity | Remove / Install Drawers | Adjust Doors

INSTALLATION GUIDE

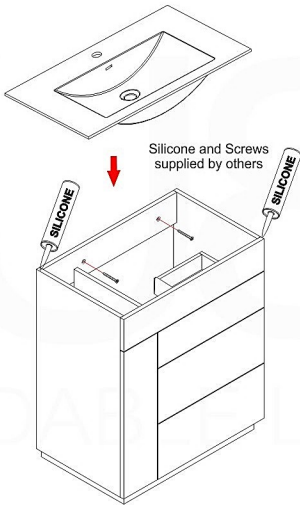

1. Determine your vanity placement and mark the area on the wall where it will be installed.
2. Locate and mark the location of the studs to which you will fasten your vanity. You can find studs by listening for a solid sound as you knock on the wall or by using a stud finder.
3. If your vanity cabinet has a solid back, mark and drill holes to accommodate drain pipes and supply pipes as necessary.
4. Place the vanity in the installation location. Verify that the vanity cabinet is level. If the vanity is not level, use vanity feet (if included) or wooden shims to adjust as necessary.
5. Attach the vanity to the wall by screwing through the mounting rail in the back of the vanity cabinet into the wall studs.
6. Install the integral sink/vanity top by applying a dot of silicone sealant on the corners of the vanity. Position the vanity top onto the vanity and press firmly into place. Wipe away any excess sealant with a damp cloth.

Note: We recommend consulting professional help if you are unfamiliar with installing bathroom vanities and/or plumbing.

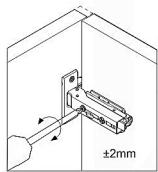

Side adjustment

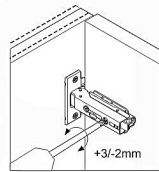

Depth adjustment via worm gear

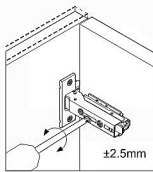

Depth adjustment via worm gear

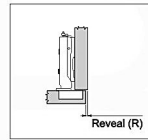

Full Overlay/ Overlay Door

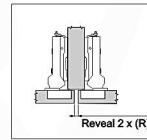

Half Overlay Door

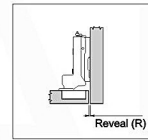

Inset Door

REMOVE DRAWERS

(Locate the plastic clips or screws on the bottom of the drawer)

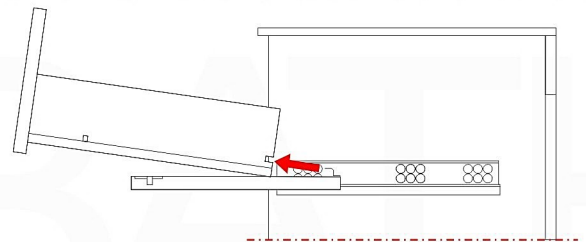
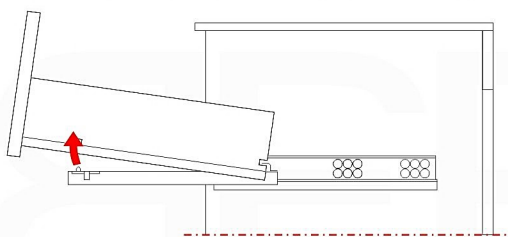
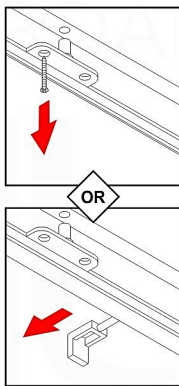

INSTALL DRAWERS

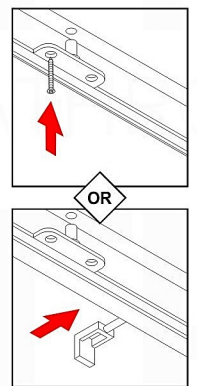
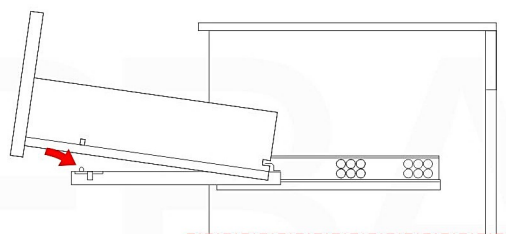
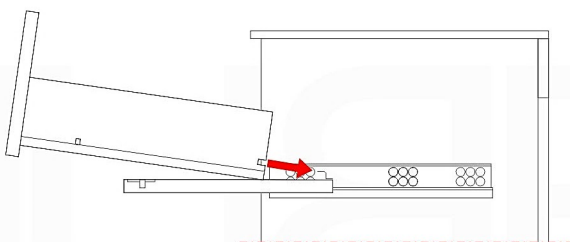

Pop-Up / P-trap Installation Instructions

INSTALLATION GUIDE

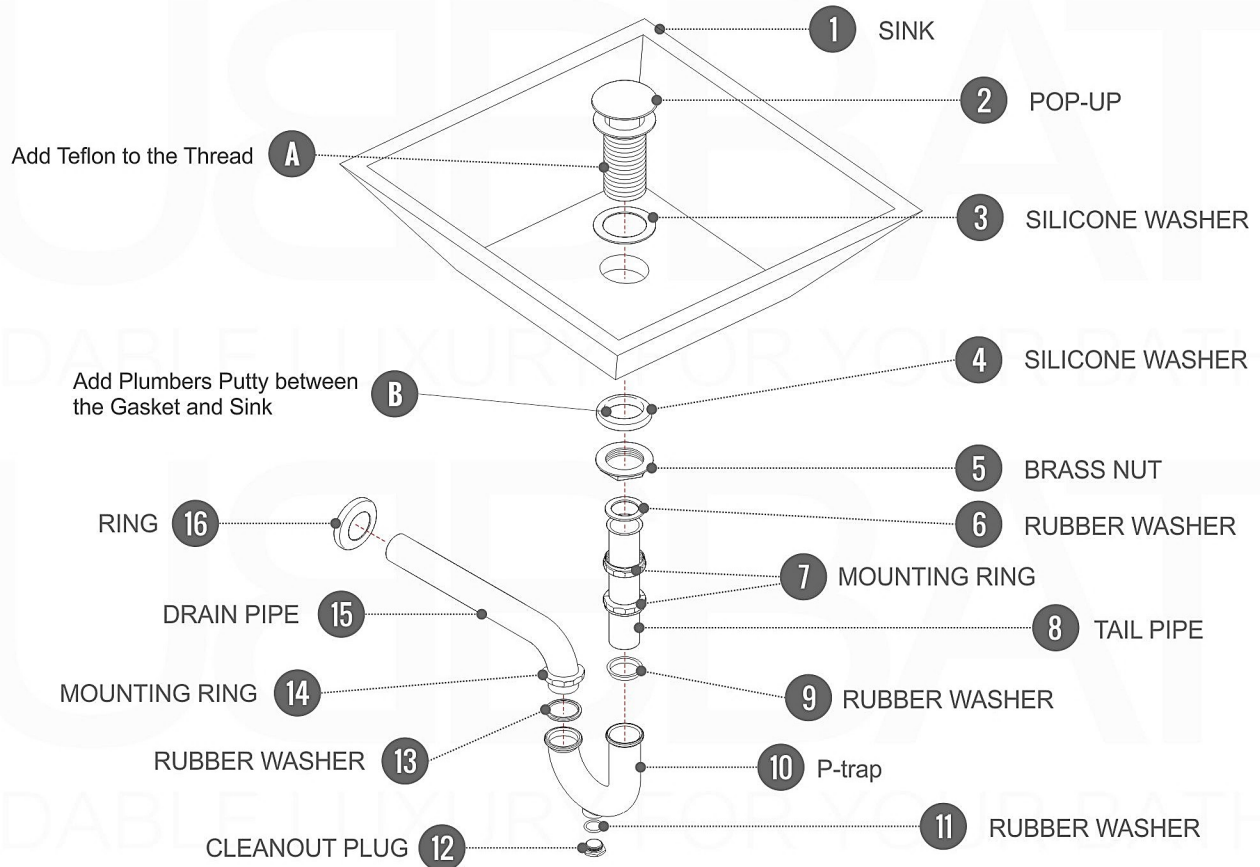

FOR SINKS WITHOUT OVERFLOW
#SKU: P101N / P102N

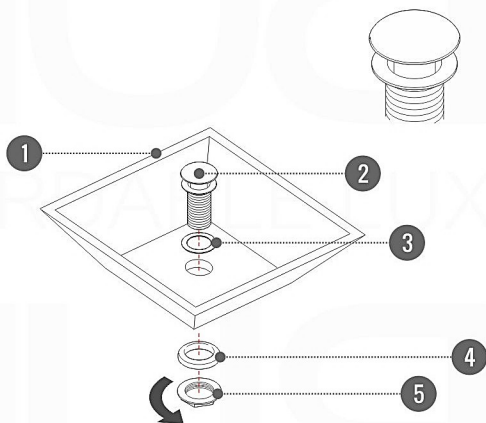

FOR SINKS WITHOUT OVERFLOW
#SKU: P101 / P102

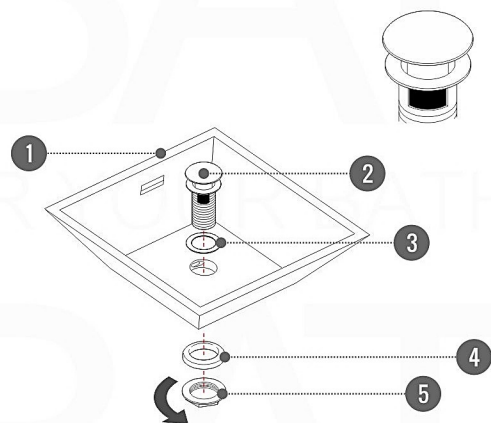

OR