

ASSEMBLY INSTRUCTIONS

FEATURES:

- Easy assembly and installation
- High quality, long lasting, weather resistant aluminum extrusion
- Distributes load pressure to prevent stress on sheets
- Upper Profile fixes to the Lower Profile for a secure finish
- High quality gaskets prevent the penetration of water, dust, and dirt
- Seamless finish with concealed screw covers

Negative pressure = 100.8 PSF

Positive pressure = 150 PSF

*Tested under the guidelines of ASTM E330 *Call for details**

ASSEMBLY INSTRUCTIONS

Recommended Accessories



Cod. 2760
Gasket for Aluminum Profile

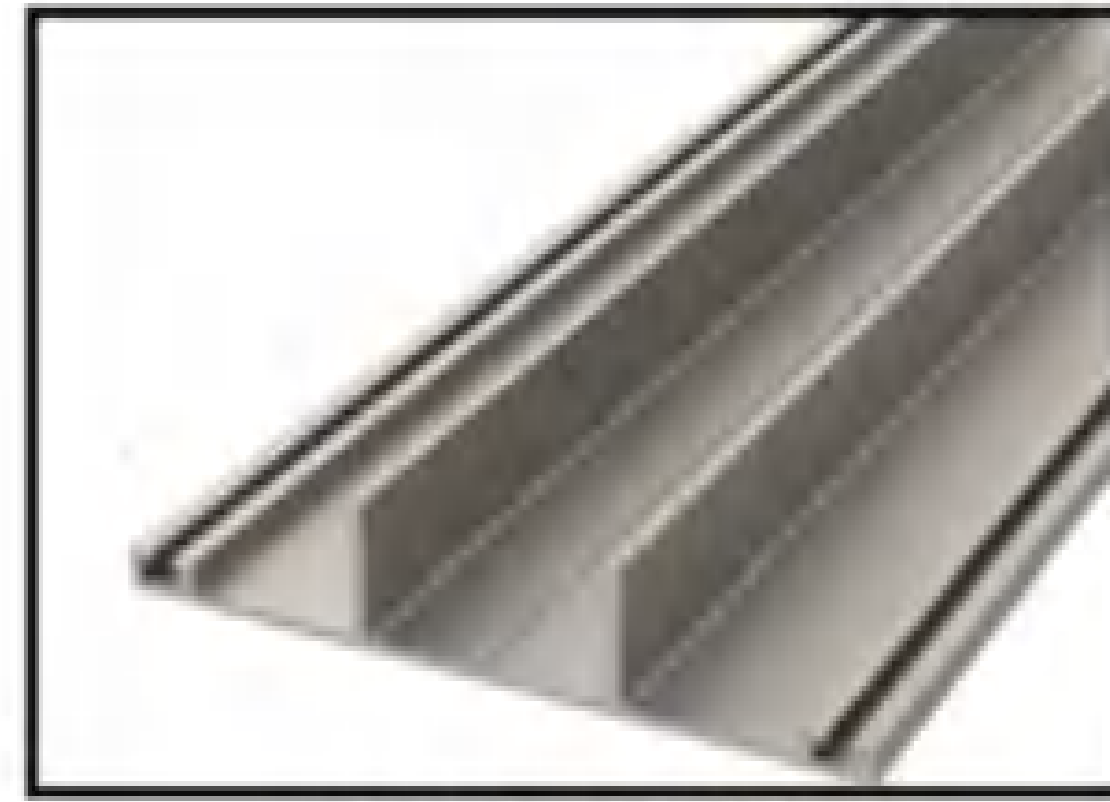

Cod. 4893
Lower Aluminum Profile H 2/12



Cod. 2761
Thermal Brake Profile



Cod. 4894
Lower Aluminum Profile 16/25

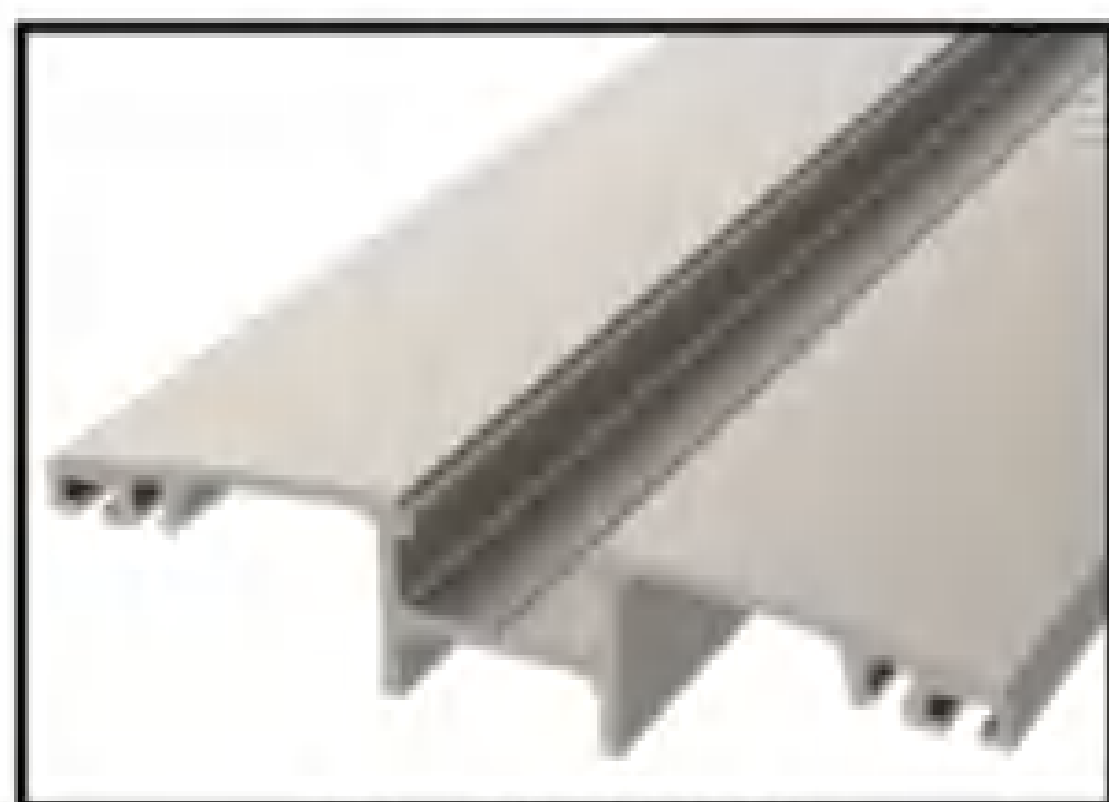

Cod. 4891
Upper Aluminum Profile 2/25

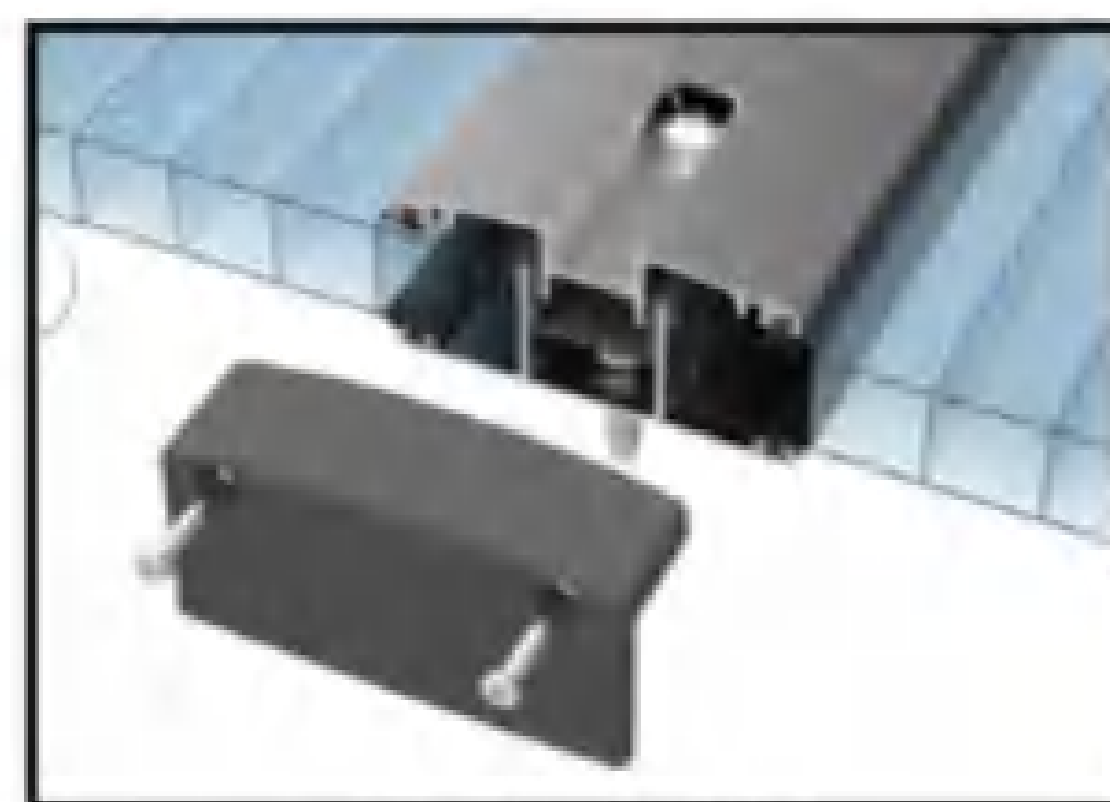

Cod. 4898
Poli-Lok Plug using #10 by 1" fastener



Cod. 4892
Hidden Screw Profile 2/25



Polycarbonate

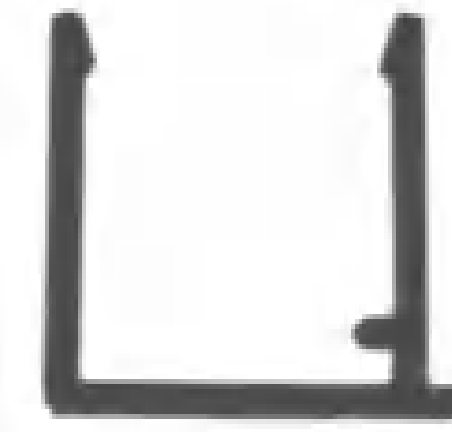

16mm Aluminum U Profile



Galvanized Neoprene Backed Washer



Polycarbonate U Profile
6, 8, 10, 16, 25mm U Profile
Comes in 4', 8', 12', and 24' Lengths



Bubble Washer



Vented Tape



Solid Aluminum Tape

Recommended Accessories

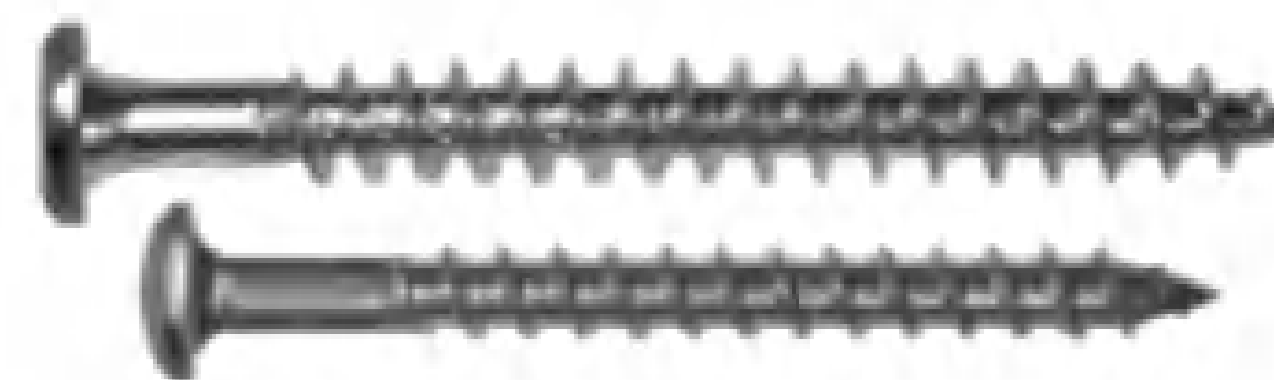

#10, #12, or #14 self-tapping pan head fastener
(1.5 - 2.5 inches)



Flashing

Please read over all the following instructions prior to installation

Any trimming done to polycarbonate should be done with a jig or circular saw

Step 1 – Start working from the left side of the roof structure making your way to the right. Place the Lower Aluminum Profile (Cod.4893 or Cod.4894) evenly along the length of the left side rafter (or across purlins).

Step 2 – Insert the gaskets Cod.2760 into the left and right side of the Lower Aluminum Profile (Cod.4893 or Cod.4894). Trim the gaskets to sit flush to the end of the Lower Aluminum Profile (Cod.4893 or Cod.4894)

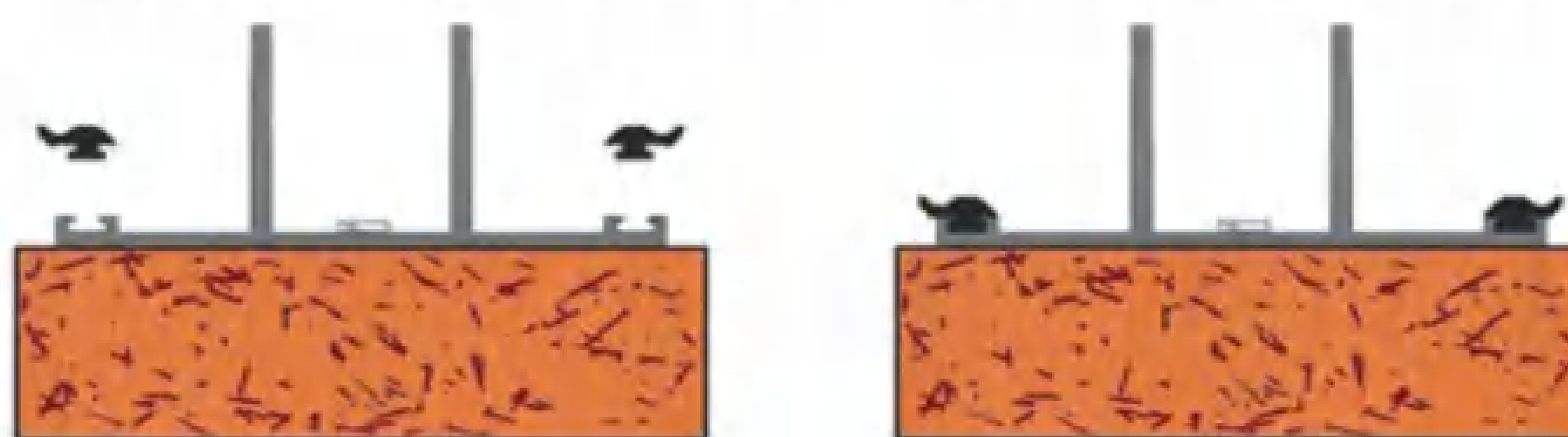

Step 3 – Place the Lower Aluminum Profile (Cod.4893 or Cod.4894) on the far-left rafter (or purlin). Predrill every 2 ft with a 1/4" drill bit through the middle of the Lower Aluminum Profile (Cod.4893 or Cod.4894) and into the rafters (or purlins).

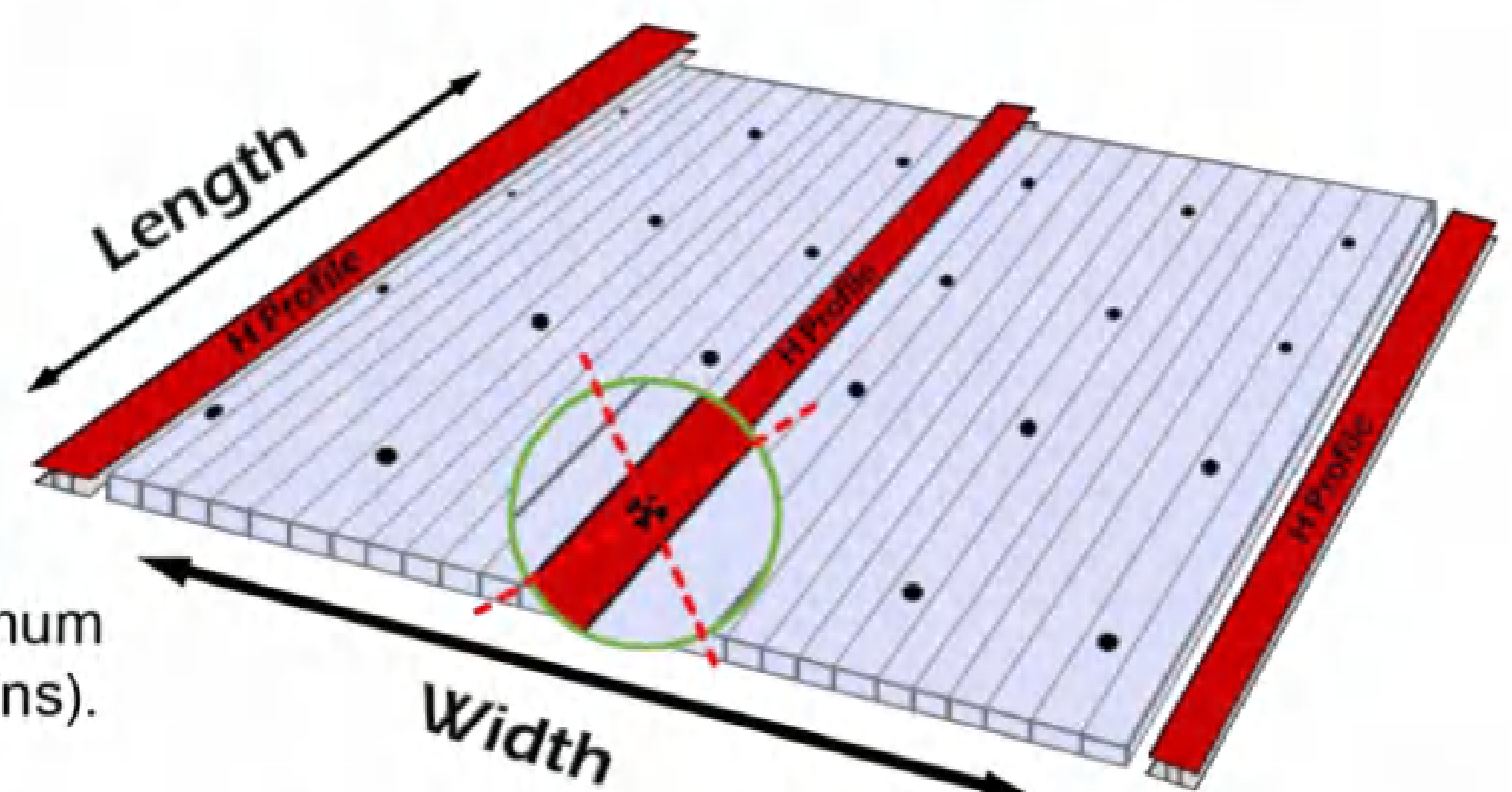

Step 4 – Fasten the Lower Aluminum Profile (Cod.4893 or Cod.4894) to the rafters (or purlins) using a minimum of 1½” #10 recessed pan head self-tapping screws. *****DO NOT OVERTIGHTEN*****

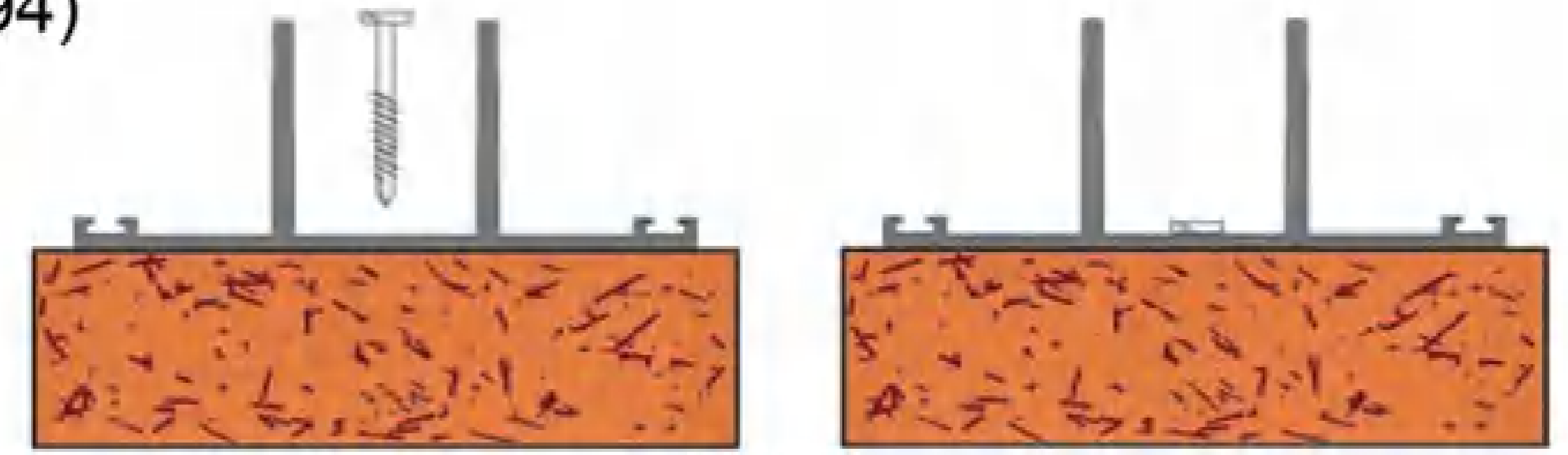

Step 4

Step 5 – Insert Thermal Brake Profile Cod.2761 into the Lower Aluminum Profile (Cod.4894 or Cod.4894).

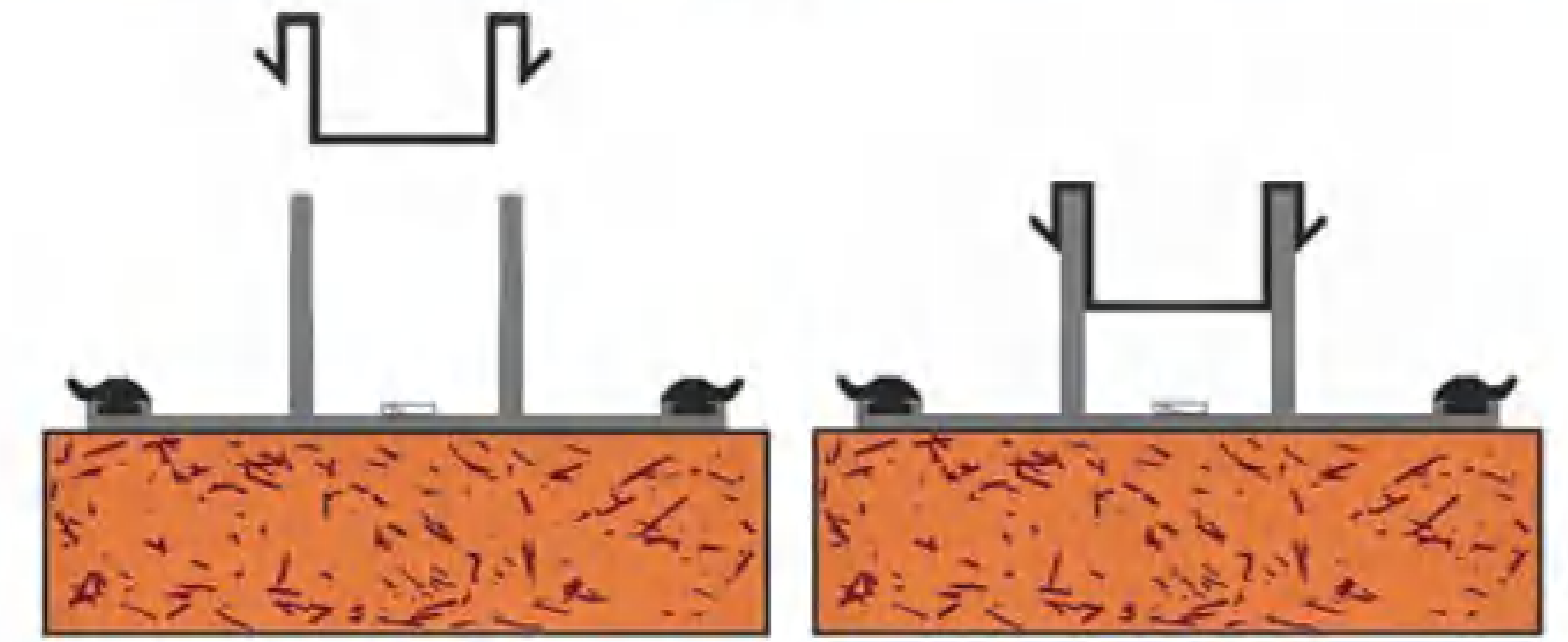

Step 5

Step 6 – Moving right, repeat steps 2 through 5.

Step 7 – Measure the distance between the two profiles inside walls to get the dimensions of your sheet. Keep in mind there is 1/8” per 4 ft needed for the polycarbonate to expand and contract.

Step 8 – Leave the polyethylene film on the polycarbonate sheet while cutting to length. These cuts need to be performed at a high speed while moving slowly down the sheet. Use a circular (80+teeth) or fine-toothed jig saw.

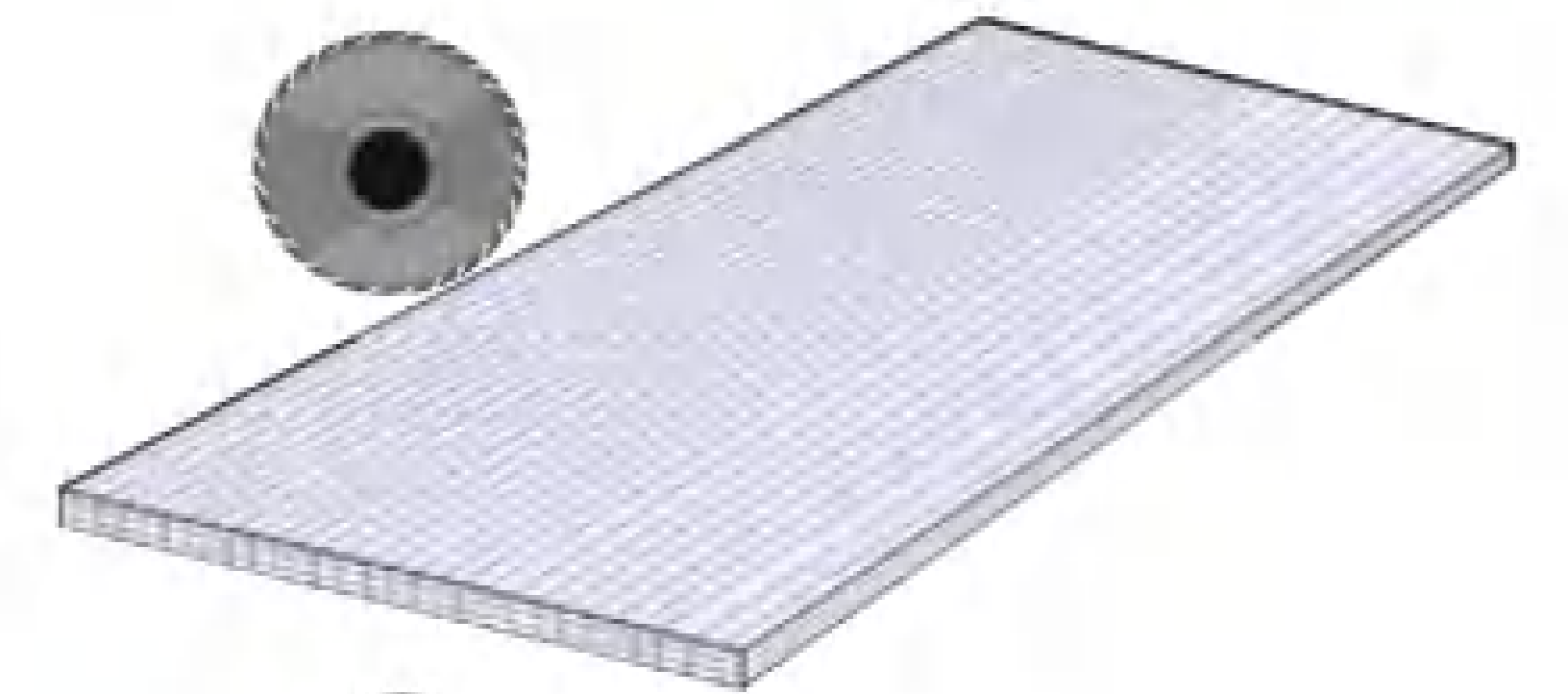

Step 9 – Peel the film at least 5” from the sides to apply Aluminum Tape to the top flutes and Vent Tape to the bottom flutes of the sheets.

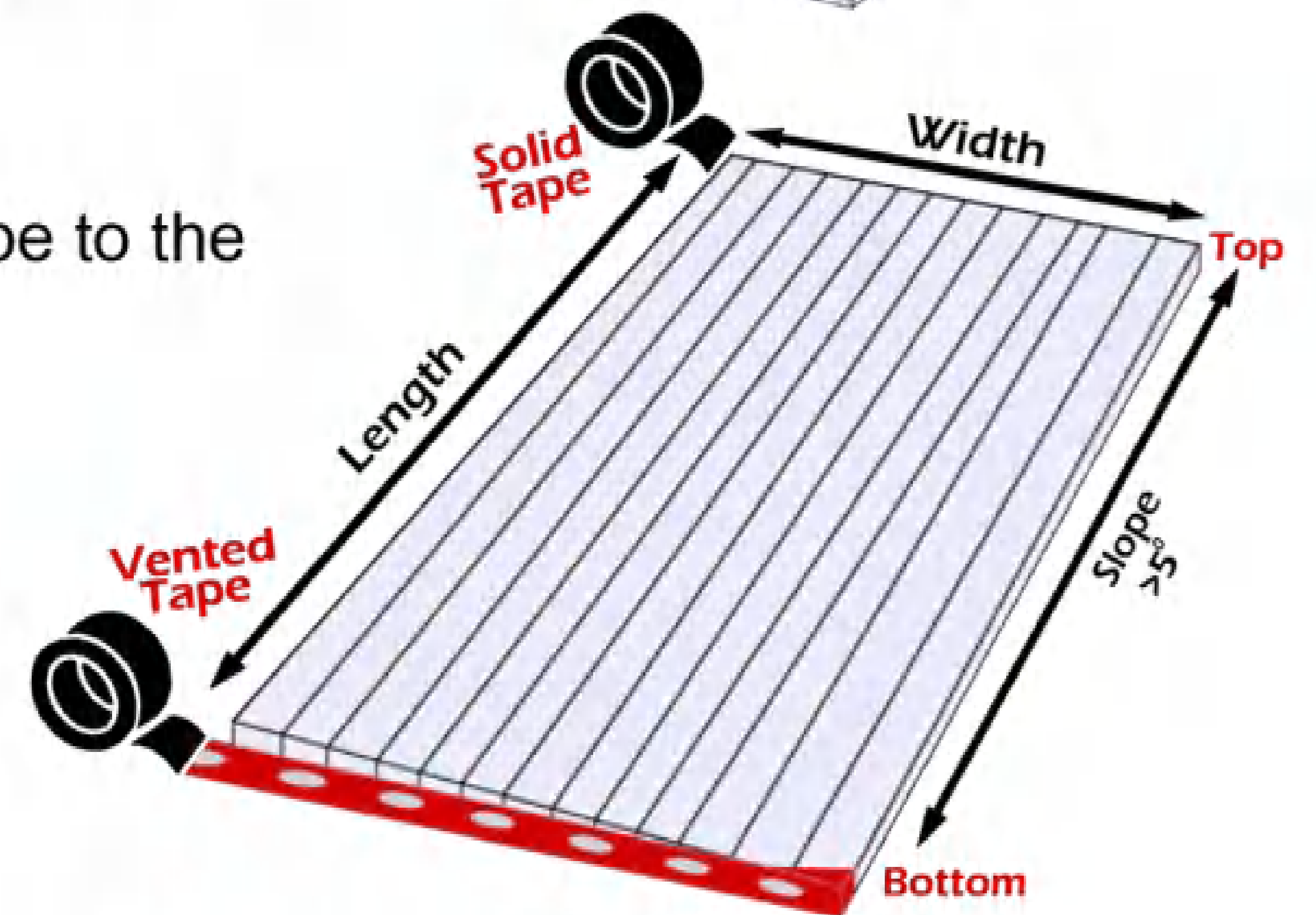

Step 10 – Cut the U Profile to the length of the Polycarbonate sheet and attach the ends.

Step 11 – With the UV side facing up, lay the Polycarbonate onto the Lower Aluminum Profile (Cod.4893 or Cod.4894), leaving 1/8” per 4 ft to allow the polycarbonate to expand and contract.

The following stages apply to the left most profile only
(Do not tighten the right side down before both sides are holding polycarbonate)

Step 12 – Insert the gaskets Cod.2760 into the left and right side of the Upper Aluminum Profile Cod.4891. Trim the gaskets Cod. 2760 to sit flush to the end of the Aluminum Poli-Lok.

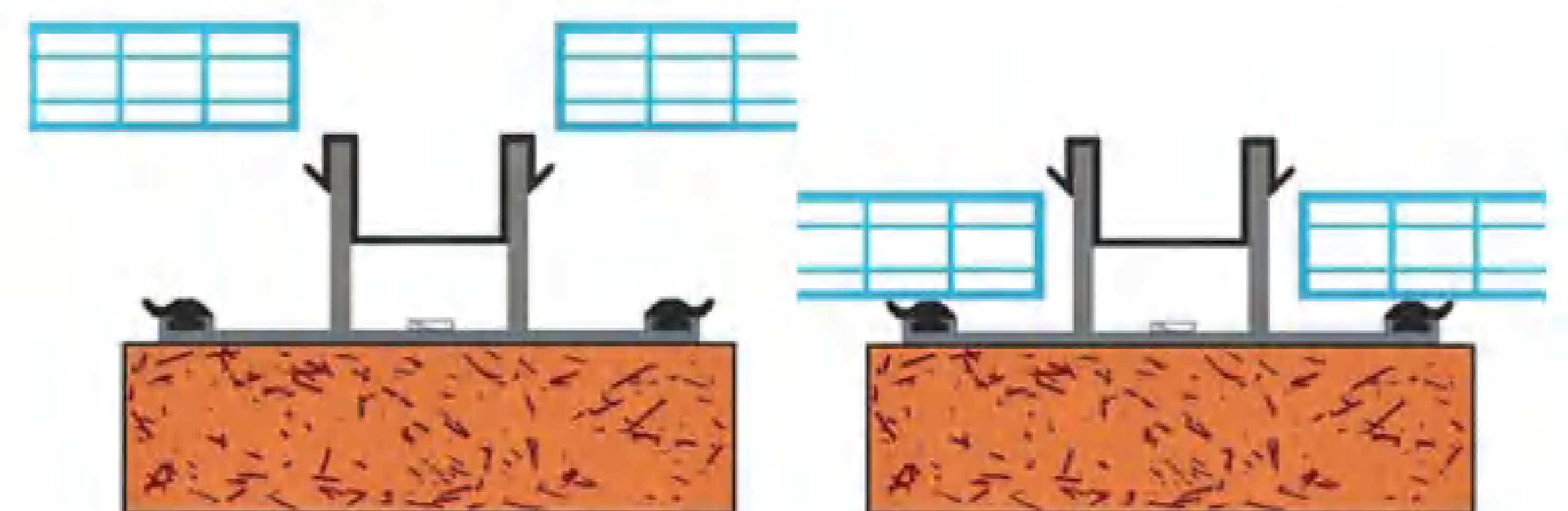

Step 11

Step 13 – Join the Upper Aluminum Profile Cod.4891 to the Lower Aluminum Profile (Cod.4893 or Cod.4894) and clasp together.

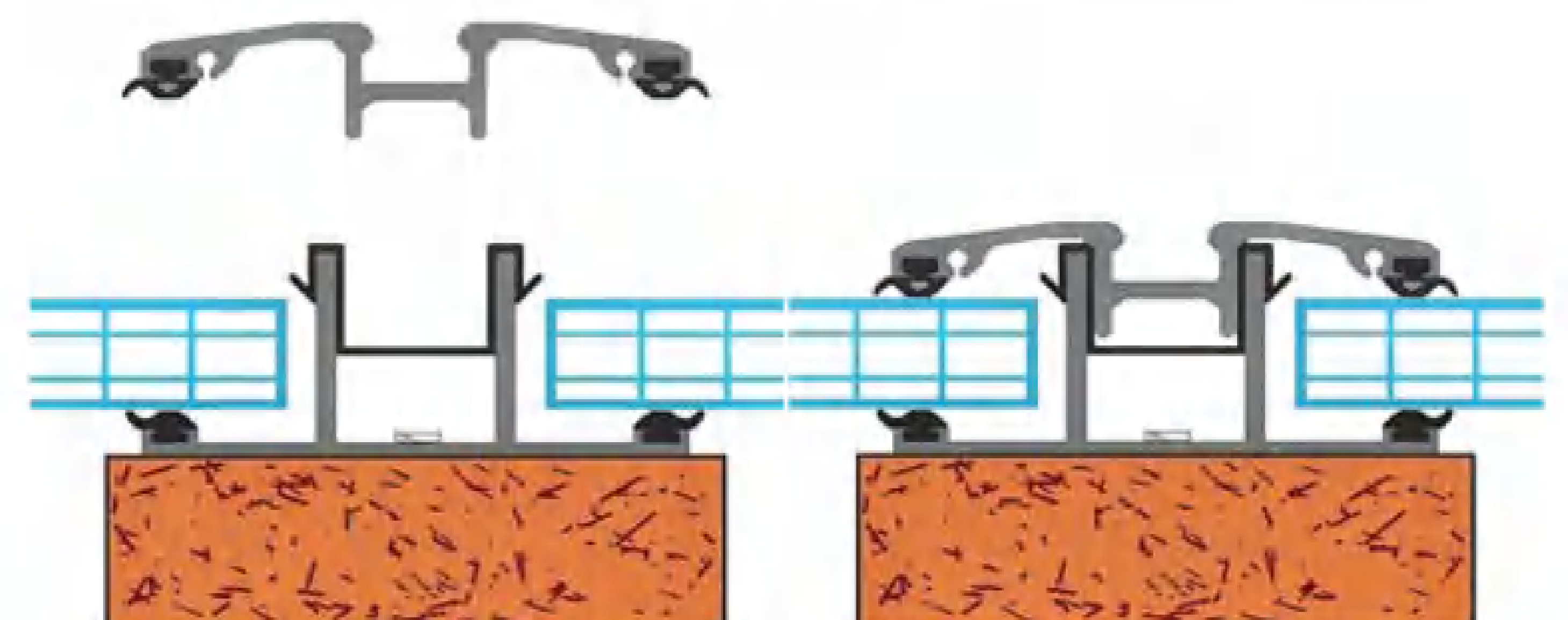

Step 13

Step 14 – Predrill approximately every 2 ft using a 1/4” drill bit. Pre-drill through the Upper and Lower Aluminum Profile into the rafters or purlins. (Offset these screws from those already in the Lower Aluminum Profile so they do not collide or rub)

Step 15 – Use #10 2 1/2" recessed self-tapping pan head screws to attach the Upper and Lower Aluminum Profiles to the rafters or purlins. ***DO NOT OVERTIGHTEN***

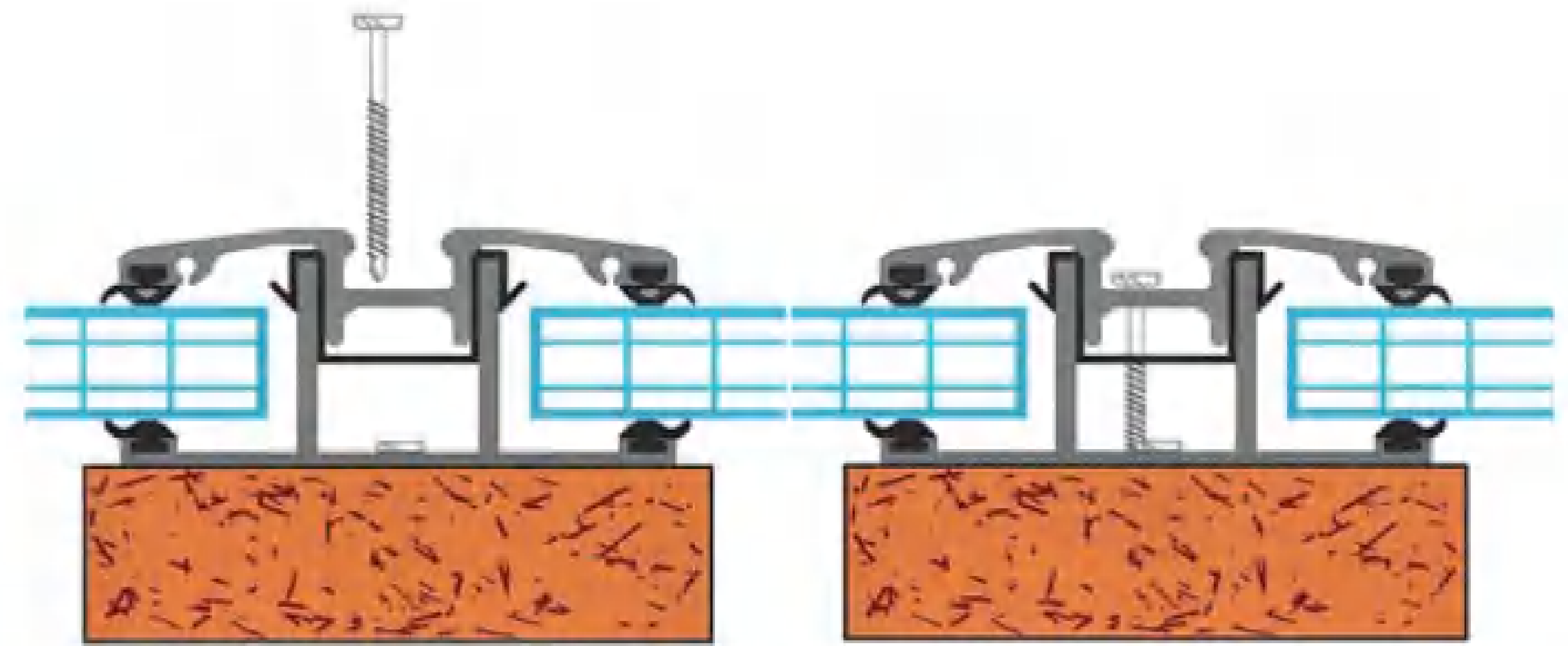

Step 15

Step 16 – Insert the Concealed Screw Covering Cod.4892 to the top of the Aluminum Profile Cod.4891.

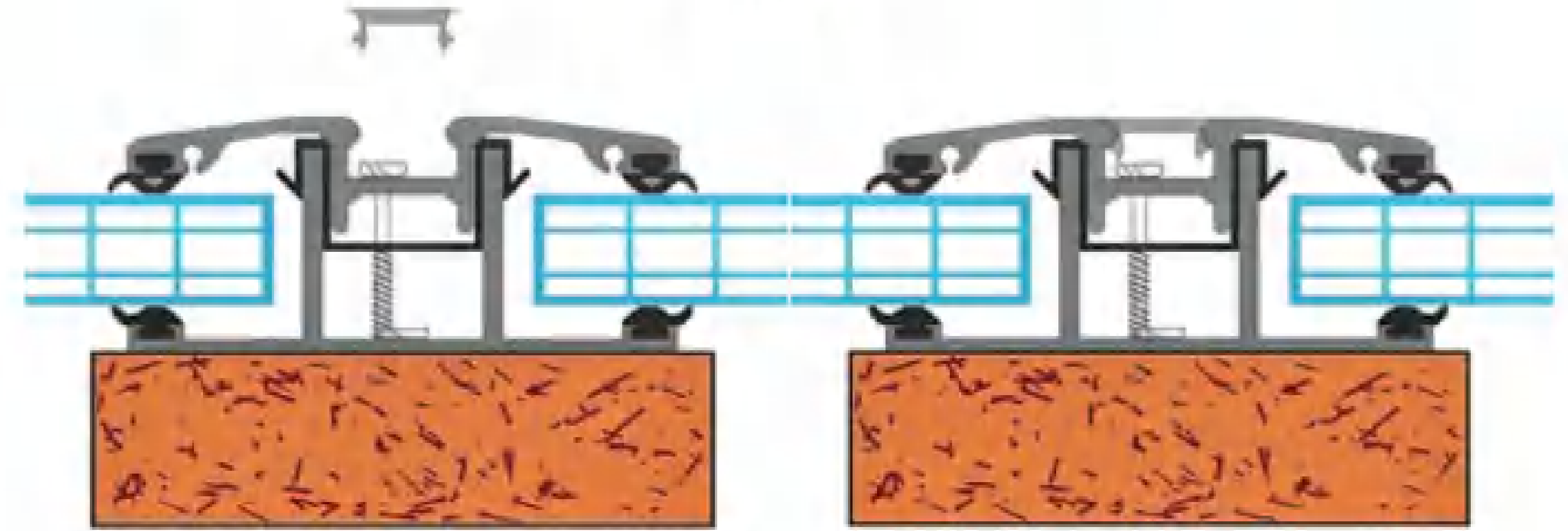

Step 16

Step 17 – Move to the right and repeat the above steps until you reach the end of the roof.

Step 18 – When completed, attach the Aluminum Poli-Lok Plug Cod.4898 using a #10 by 1" fastener and cut the Cod.4898 Plug to the desired length.

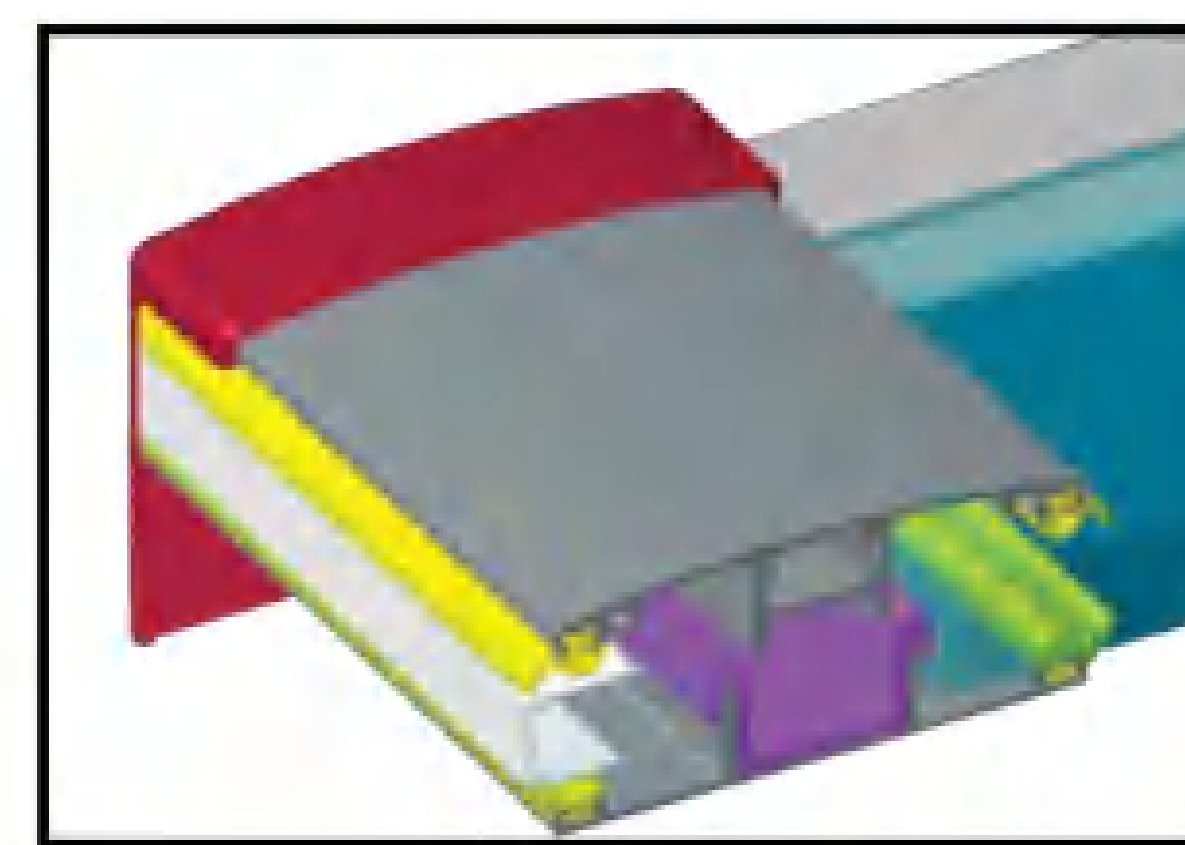

Aluminum U profile:

- Cut the U-Profile to the full length of the Poli-Lok®
- Fit the U profile into the side of the PoliLok and fasten the top into place

Step 19 – Once everything is screwed into place, flashing must be applied to the top of the structure where the polycarbonate meets the house.

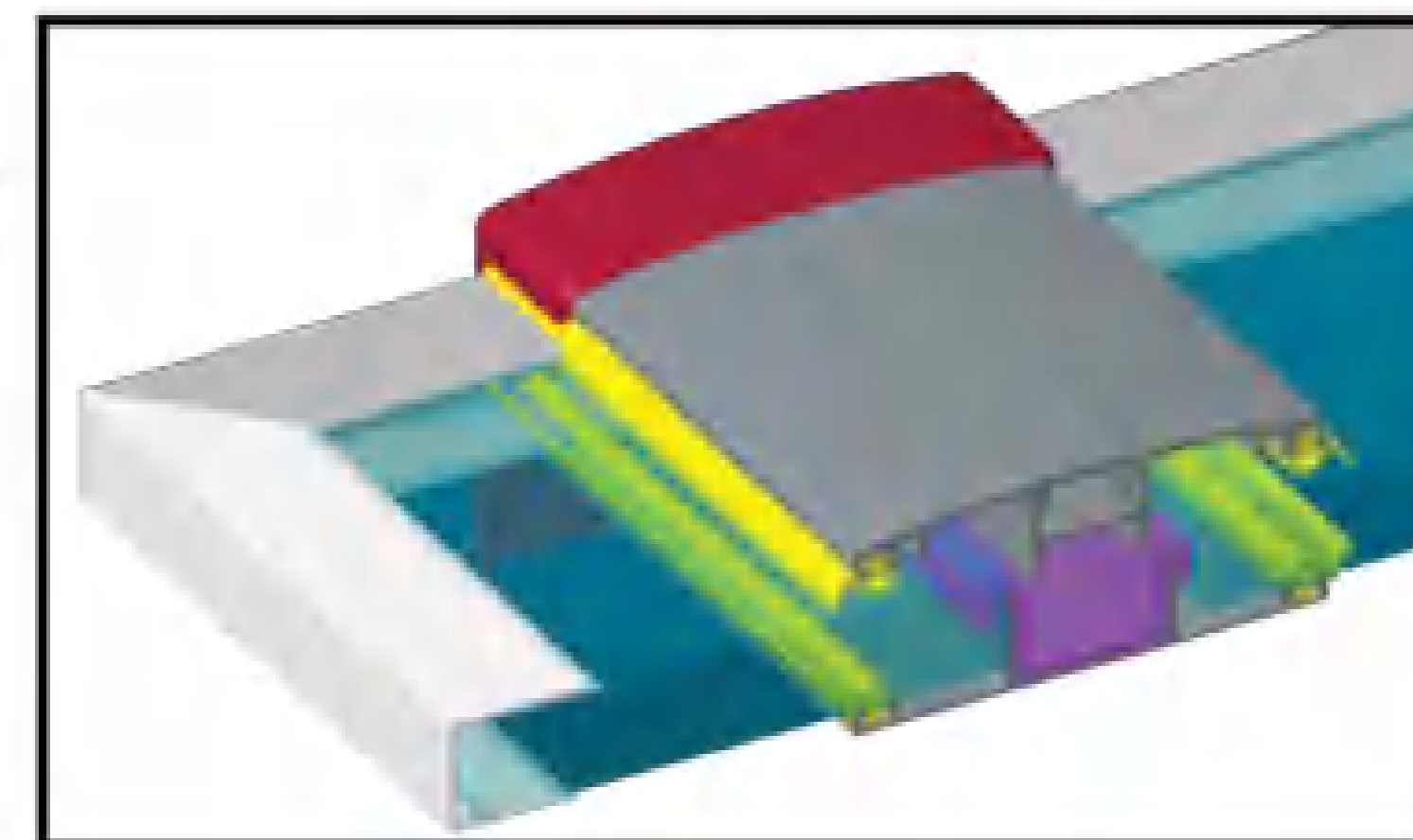

Polycarbonate trim with U Profile:

- Trim 3-4" by full width piece of polycarbonate sheet
- Fit the polycarbonate trim into the side of the Poli-Lok®
- U profile can be to the cut sheet as desired

Step 20 – To further secure your structure, you may choose to fasten through the polycarbonate sheet and into the rafters (or purlins). To do this, predrill with a 1/4" drill bit, fasten using a #10 2" wood or #10 recessed pan head self-tapping screw with a bubble or a galvanized neoprene backed washer in between.

