

INSTALLATION | DECK FOOT ANCHOR™ Ledger

IMPORTANT



THIS PRODUCT IS DESIGNED FOR FREE-STANDING AND LEDGER CONNECTED STRUCTURES. IT MAY NOT WORK IN YOUR SOIL. ROCKS, ROOTS OR A WEAK IMPACT WRENCH MAY PREVENT THE AUGER FROM DRIVING FULLY INTO THE SOIL. CONTINUOUS TORQUE, ONCE STOPPED BY AN OBSTRUCTION, CAN DESTROY THE AUGER. IMPROPERLY SIZED SOCKETS CAN STRIP THE DRIVER HEAD. DESIGNED FOR COMPRESSION LOAD APPLICATIONS ONLY.

LOAD FIN™ COMPRESSION

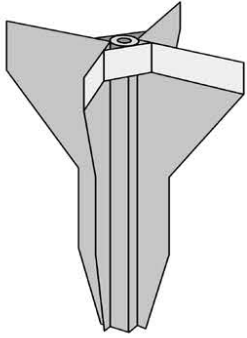

FF4511-C

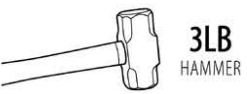

3LB
HAMMER

AUGER

M16 2.0 THREAD

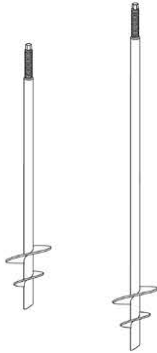

36"
TIGA9002

48"
TIGA12502

POST SADDLE



4x4 TIDP442/444

— or —

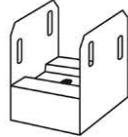

6x6 TIDP662/664



1/4 X 3" LAG SCREWS SOLD SEPARATELY

TOOLS NEEDED

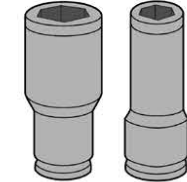

12 MM AND 24 MM, 6 POINT DEEP IMPACT SOCKET



DO NOT USE 12 POINT SOCKET

1/2" IMPACT WRENCH 350 FT-LBS CORDED OR 18V CORDLESS

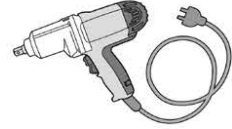

1/2"

— or —

OPTION 1

HAND AUGER TOOL

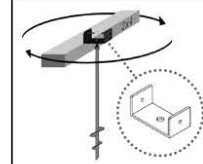

DIYers! AT2035

SOLD SEPARATELY. WOOD & FASTENERS NOT INCLUDED.

OPTION 2

24" BREAKER BAR

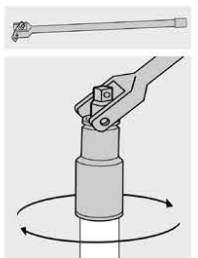

1 Remove sod and any organic material.

Add 2"–3" of 1/2" crushed stone or stone dust base.

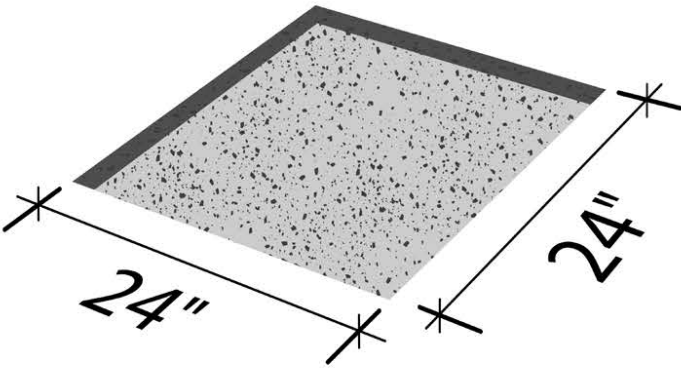

2A Drive the Auger into the soil.

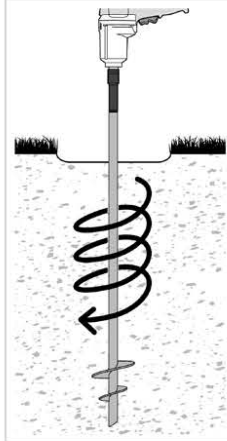

2B Drive the Auger down and stop it when the threads reach the soil surface.

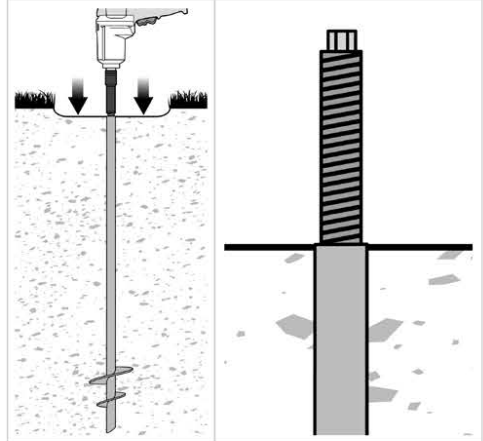

3 Compress soil in circular motion around auger.

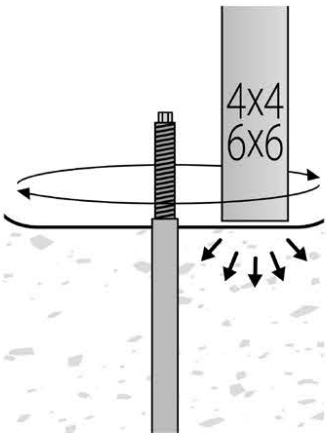

4A Post Saddle and Load Fin orientation.

— IMPORTANT —

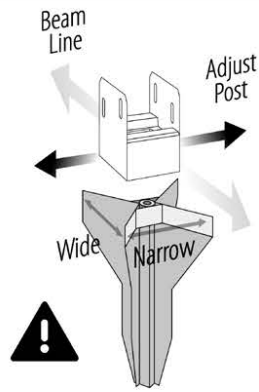

4B Load Fin installation onto Auger.

OPTION 1

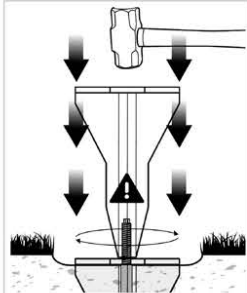

Hammer in circular pattern so threaded rod passes through hole without damage.

OPTION 2

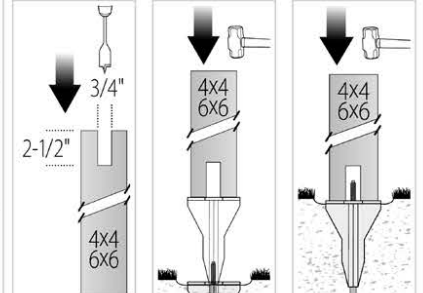

Drive Load Fin with hammer and post block.

ATTENTION



INTERTEK ENGINEERING REPORTS ARE FOR GUIDANCE ONLY AND SUBMITTING THEM IN SUPPORT OF A BUILDING PERMIT APPLICATION DOES NOT NECESSARILY MEAN YOUR PLANS WILL BE ACCEPTED BY LOCAL BUILDING OFFICIALS.

REV: 03/13/24

ENGINEERING REPORTS FOR APPLICATION SUITABILITY



DECK FOOT ANCHOR™ LEDGER / FF4511-C / TIDP442/444/662/664 / TIGA900/12502

PATENT NO. PENDING

T 1-866-577-8868

TITAN BUILDING PRODUCTS®
THE ART OF BUILDING
More Outdoor Beauty... Real easy.



www.titanbp.com

INSTALLATION | DECK FOOT ANCHOR™ Ledger

5 Washer and nut combinations depend on height of nuts.

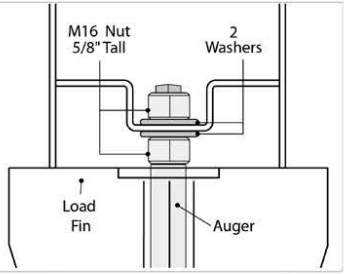

— or —

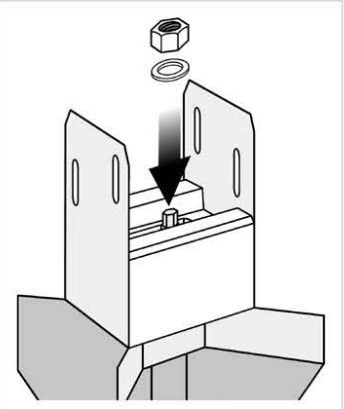
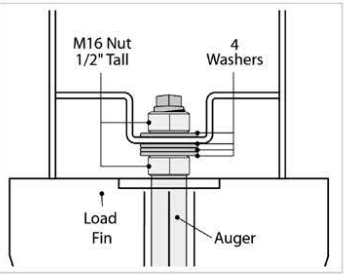

6 Adjust the Post Saddle horizontally to the Beam Line.

— IMPORTANT —

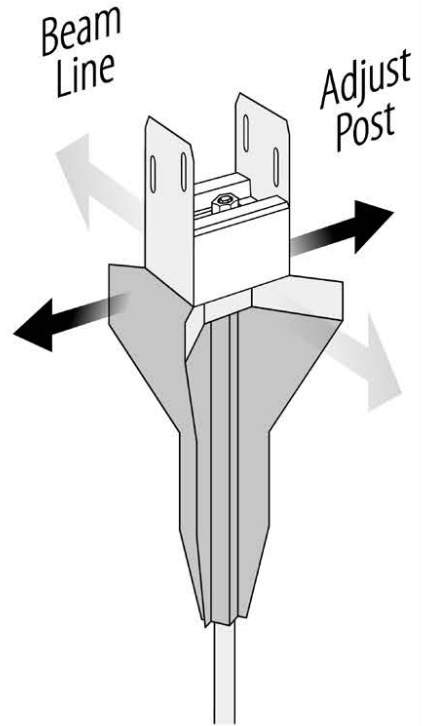

7 Placement of the Load Fin and Post Saddle in relation to the Beam Line.

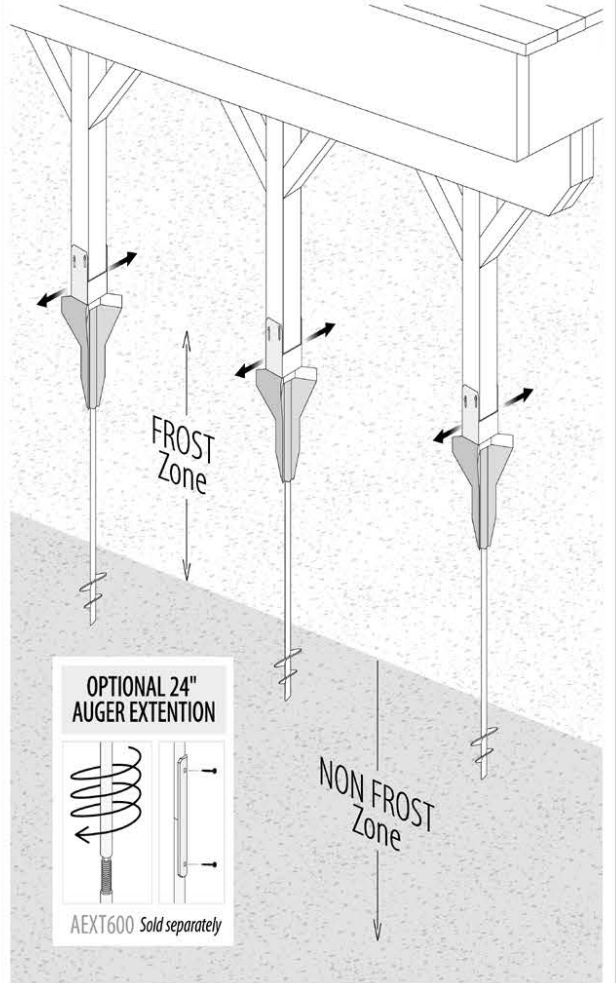

HOUSE

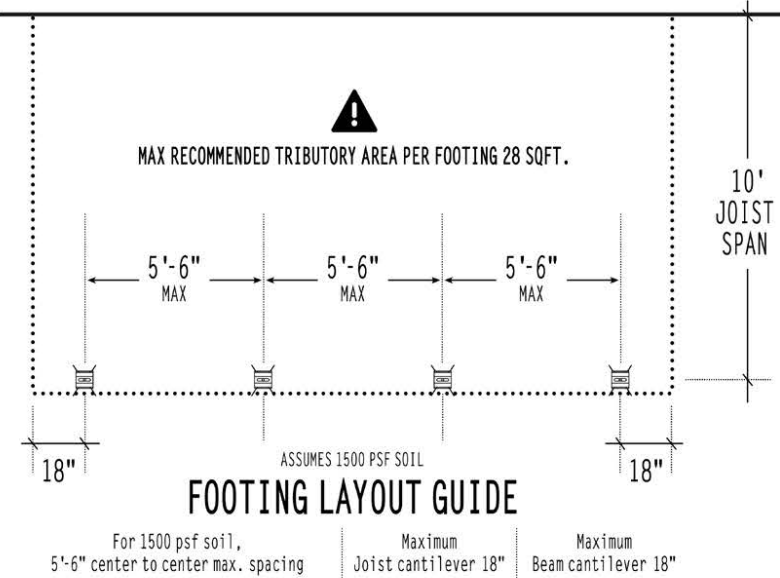

COMPRESSION LOAD

AUGER		SOIL TYPES	
LENGTH	BLADE DIA	SAND	CLAY
36"	3-1/4"	6285 LBS	1400 LBS
48"		>6285 LBS	>1400 LBS

DECK FOOT ANCHOR™ LEDGER / FF4511-C / TIDP442/444/662/664 / TIGA900/12502

PATENT NO PENDING

ATTENTION: Before beginning work, consult with local building officials or engage professionals to ensure that this product is appropriate for your intended use or help clarify if these warnings are unclear or if you do not understand any of the information in this installation guide. Always comply with applicable building codes and be advised that building codes may vary.

QUESTIONS? CONTACT US AT 1-866-577-8868 IN NO EVENT SHALL TITAN BUILDING PRODUCTS BE LIABLE FOR ANY LOSS OR DAMAGE, DIRECT OR OTHERWISE, WHICH RESULTS FROM THE IMPROPER INSTALLATION OR USE OF THIS PRODUCT. IF FOR ANY REASON TITAN BUILDING PRODUCTS BECOMES LIABLE FOR LOSS OR DAMAGE, DIRECT OR OTHERWISE, THE AGGREGATE LIABILITY OF TITAN BUILDING PRODUCTS SHALL BE LIMITED TO THE RETAIL PURCHASE PRICE OF THE PRODUCTS.

T 1-866-577-8868

TITAN BUILDING PRODUCTS
THE ART OF BUILDING
More Outdoor Beauty... Real easy.



www.titanbp.com